

**ASSEMBLY INSTRUCTIONS**  
**TEAK ROUND SIDE TABLE**  
**IT-180706**

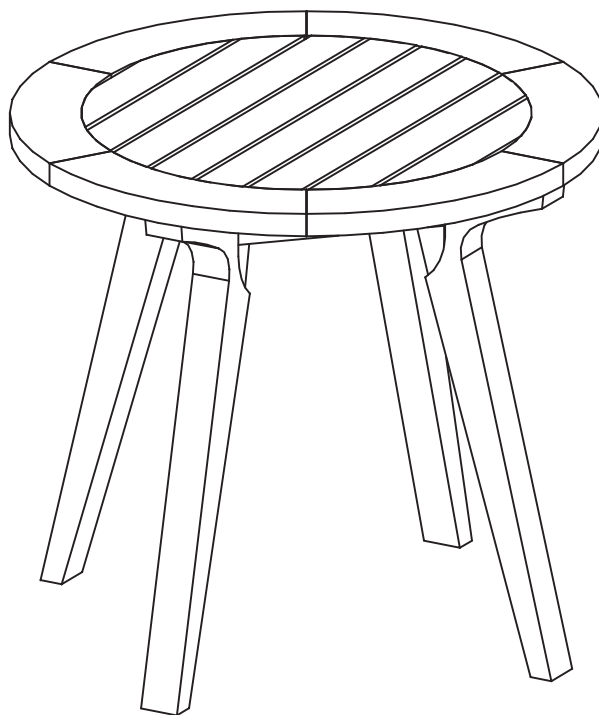

**CUSTOMER SERVICE INFORMATION**

**Please do not return to the store. If any pieces are missing call our toll free number at 1-888-287-4275 from 9:00 am to 5.00 pm CST (Monday to Friday) for replacement parts. For faster service, have the style number handy when calling.**

## GENERAL INFORMATION & TIPS

1. Please read the assembly instructions prior to assembling the table.
2. To avoid damage, assemble the table on a non-abrasive surface such as carpet.
3. Make sure all nuts tightly fastened before the table is used.
4. This table is not for commercial use.



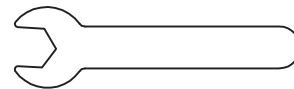

Please make sure you have all parts before beginning assembly. Please wait until all steps are completed before tightening nuts.

### TOOLS REQUIRED

1. Wrench (Provided).
  - For tightening all nuts

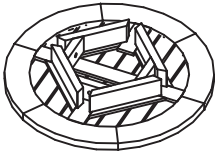
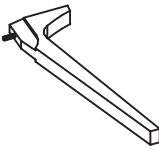

## PARTS AND HARDWARE LIST

A. Table top	B. Leg Frame	C. Washer	D. Spring washer
			
Qty : 1 pc	Qty : 4 pcs	Qty : 4 pcs + 1	Qty : 4 pcs + 1
E. Nut			
			
Qty : 4 pcs + 1			

## STEP 1

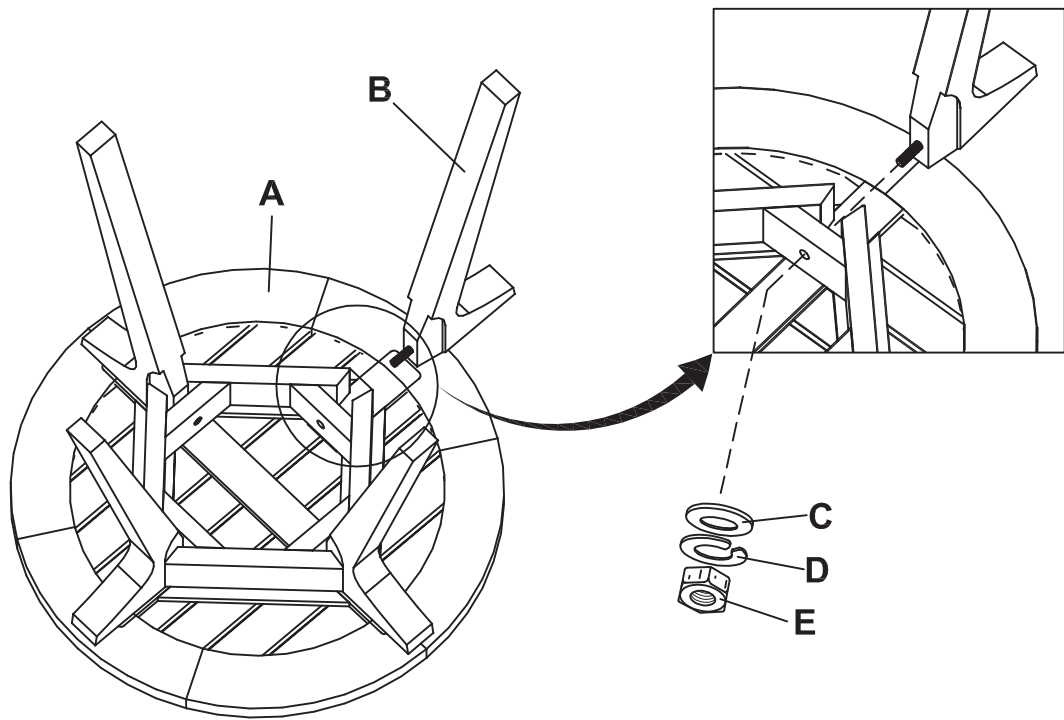

- Attach legs (B) to the table top (A) and secure each leg with washers (C), spring washers (D) and nuts (E) as shown.

## STEP 2

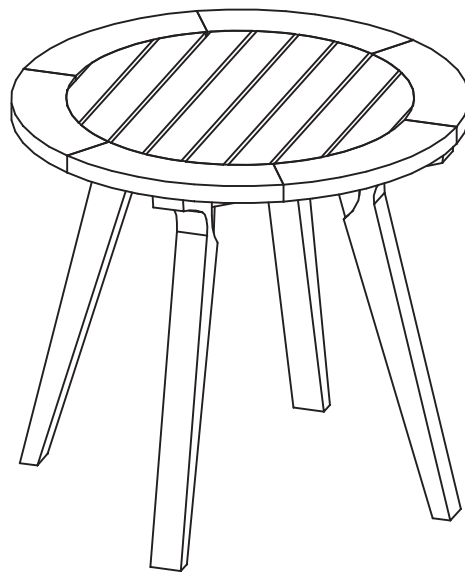

- Make sure all parts are correctly connected and tighten all nuts completely using screwdriver.
- Next, upright the table.

THE TABLE IS NOW READY FOR USE.