

PERFORM & MASTER

100+  
MIND BLOWING  
TRICKS

INSTRUCTION  
MANUAL

MEGA

MAGIC

COLLECTION



[www.learnandclimb.com](http://www.learnandclimb.com)



Learn & Climb



Learn & Climb



@LearnandClimb

Learn & Climb LLC  
©2021 all rights reserved



## We are here to help!

For any questions, comments or for assistance with the science kit or manual please contact us. We will be happy to assist you!

**[support@learnandclimb.com](mailto:support@learnandclimb.com)**

Want to unlock online videos to all of the tricks found here? Simply go to [www.learnandclimb.com](http://www.learnandclimb.com) then click the video link found at the top of the page, and go to

**MAGIC**





# Magic Contents

Cups and Balls, Coin Escape, Finger Chopper, JQK card, Tube and Dice, Spiked Coin, Appearing Silk, Rainbow Bricks, Rings and Coin, Magic Mystery Spinner, Growing wand, Sword penetrates glass, Emotion Box, Traffic light, Cube and Box, Magic rope, Rope Cutter, Illusion box, Growing cards, Ball and Vase, Dove family, Lighting box, Floating Cards, Magic coin case and Disappearing Coin Cup

# TABLE OF CONTENTS

**Trick 1: Ball & Vase- Where Did the Ball Go?**

**Trick 2: Ball & Vase- Double the Ball**

**Trick 3: Ball & Vase- Multiplying Ball**

**Trick 4: Bricks Box**

**Trick 5: Magic Floating Card Tricks- The Sticking Card Trick**

**Trick 6: Magic Floating Card Tricks- Make an Object Float Trick**

**Trick 7: Magic Floating Card Tricks- Magical Mind Reading Trick**

**Trick 8: Coin Case**

**Trick 9: Coin Cup- Make Money Disappear**

**Trick 10: Coin Cup- Make Money Change Value**

**Trick 11: Coin Cup- Multiply Your Money**

**Trick 12: Cups & Balls**

**Trick 13: Dice and Tube**

**Trick 14: Emotion Box**

**Trick 15: Escaping Coin**

**Trick 16: Finger Chopper**

**Trick 17: Frame Tricks**

**Trick 18: Growing Cards**

**Trick 19: Illusion Box- Disappearing & Reappearing Card**

**Trick 20: Illusion Box- Transformation of an Object**  
**Trick 21: Illusion Box- Make an Object New Again**  
**Trick 22: Lightning Box**  
**Trick 23: Magic Wand out of Your Scarf**  
**Trick 24: Up your Nose**  
**Trick 25: Sticking into your Stomach**  
**Trick 26: Shrinking Magic Wand**  
**Trick 27: Mind Reading- Magic Box and Cube**  
**Trick 28: Mystery Spinner**  
**Trick 29: Ring Coin**  
**Trick 30: Dove Couple**  
**Trick 31: Dove Family**  
**Trick 32: Rope Cutter**  
**Trick 33: Rope Tricks- Changing Lengths**  
**Trick 34: Rope Tricks- Single Handed Knot**  
**Trick 35: Scarf Tricks- Disappearing & Reappearing Scarf**  
**Trick 36: Scarf Tricks- Transform into Another Object**  
**Trick 37: Spiked Coin**  
**Trick 38: Traffic Light**

# Trick 1: Ball & Vase

## Where Did the Ball Go?

### OBJECTIVE:

With your magic skills you will cause a ball to disappear and reappear!

### SETUP:

Find the Vase in your kit. It consists of one regular cover and one lid with a fake ball. See the diagram for how it should be assembled. Take the actual base and the lid with a fake ball already inside and set them up before showing your audience. You need your audience to think the fake ball is actually a real ball. For this you only need the two bases and cover (not the additional red ball like other tricks in the ball & vase tricks). You will also need your magic wand!

### INSTRUCTIONS:

1. Allow your audience to see the fake ball sitting in the vase by lifting the cover to the vase.
2. Place the cover back on. Give the vase a tap with your magic wand.
3. When you lift the cover this time, you will need to lift the lid with the fake ball inside together with the actual cover. Make sure to do it at the same time so it appears to be one piece. It will appear to the audience that the ball has disappeared.
4. Place the actual cover back on and give it a tap with your magic wand.
5. Pick just the cover up this time, leaving the fake base with ball on the the stand, and it will appear that the ball has reappeared.



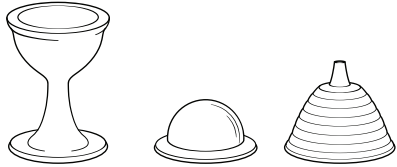

1



2

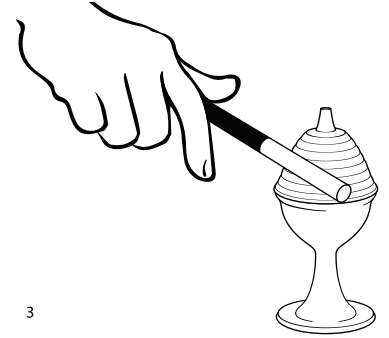

3



4

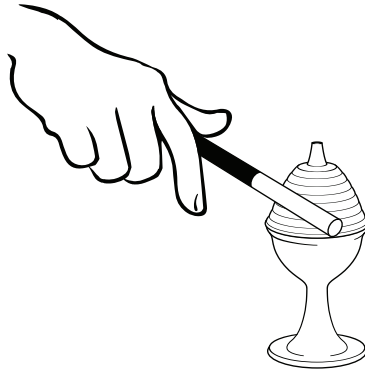

5



6

# Trick 2: Ball & Vase

## Double the Ball

**OBJECTIVE:** You have one ball. Suddenly, you have two. Magically, you created another ball!  
Wow!

Setup: Find the Magic Ball (red) and Vase in your kit. It consists of one regular cover and one lid with a fake ball. Start with all parts assembled in the vase. The real ball should be in the vase. Then place the lid with the fake ball on top of the real ball. Lastly, place the cover on top. You will also need your magic wand.

### INSTRUCTIONS:

1. Start with all parts assembled in the vase. The real ball should be in the vase along with the fake ball on top of the real ball, and then the cover over it all.
2. You will pick up the cover and the lid with the fake ball together so that the audience does not see the fake ball.
3. Take the real ball out and place it on the table or another visible place.
4. Place the cover (including the lid with the fake ball top) back on the base and give the vase a magic tap with your magic wand.
5. This next time, only lift the cover, this will leave the base with the fake ball on the vase. To the audience it will appear as if you have made the ball multiply because you now have two balls.

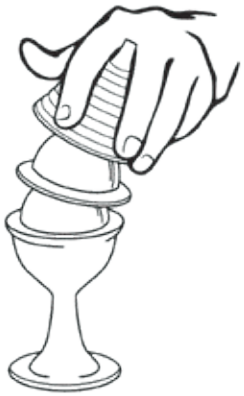

1



2



3



4



5

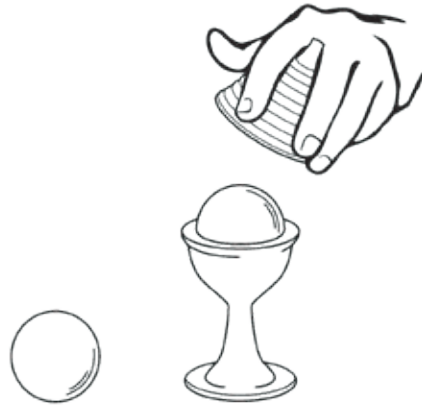

# Trick 3: Ball & Vase

## Multiplying the Ball

**OBJECTIVE:** Another way of making one ball become two right before your audience's eyes!!

### SETUP:

Find the Magic Ball (red) and Vase in your kit. The Vase consists of a lid with a fake ball, the actual vase, and a cover for the vase. See the diagram for how it should be assembled. The real ball should be in your hand, covered so the audience cannot see it. You will need to practice holding the ball hidden in your palm without the audience suspecting you are hiding it there, so that it looks natural, to trick your audience.

### INSTRUCTIONS:

1. Allow your audience to see the fake ball sitting in the vase by lifting the cover so the audience sees the fake ball.
2. Place the cover back on the vase.
3. When you lift the cover this time, you will need to lift the lidbase with the fake ball along with the cover together with one hand. At the same time you will place the real ball, that was inside your other hand, in the base without the audience noticing that you have switched them.
4. Allow them to see the real ball in the base. Take the real ball out and sit it on the table.
5. Now place the fake lid, and real cover back on.
6. Tap the vase with your wand.
7. Lift the cover, leaving the lid with the fake ball on, and show your audience that the balls have multiplied.

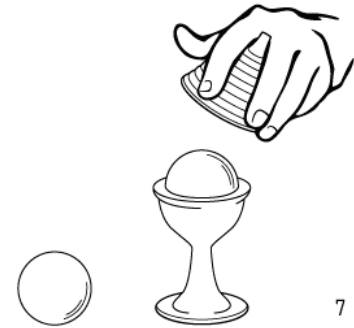
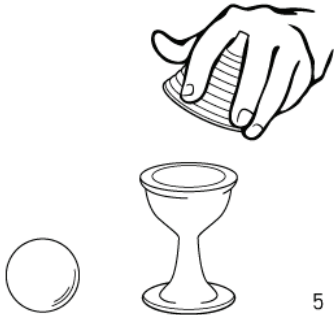
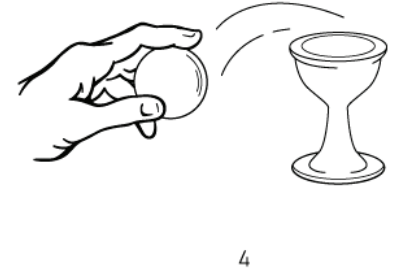
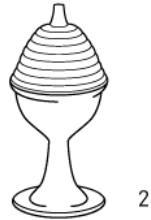

# Trick 4: Bricks Box

## OBJECTIVE:

Make your audience member's chosen bricks be stronger than a sword.

## SETUP:

Find the six bricks of different colors and the box with spike in your kit. Place the bricks out on a table.

## INSTRUCTIONS:

1. Ask an audience member to pick out two colored bricks from the six colored bricks on the table.
2. Now pick up the bricks and place them in the box with the flap up so the audience cannot see how you are placing the bricks in the box. You will place the bricks that the audience member did not pick back in the box vertical (up & down) right next to each other. Then place the two bricks that the audience member picked in the box, but place them in horizontally (sideways).
3. Close the lid to the box.
4. Holding the box up, locate the hole at the end of the box, to place the spike through. Place the spike through the hole and into the holes of the bricks. The spike should go through the four blocks they did not choose and between the two bricks the audience member did choose.
5. Now open the box, and the two blocks the audience member picked will fall out.

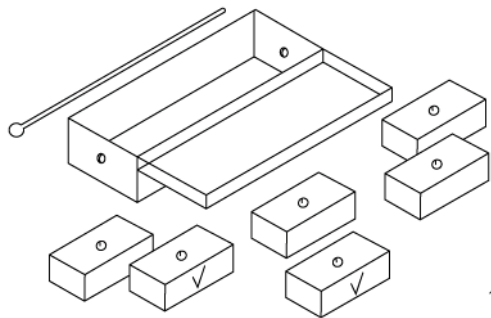

1

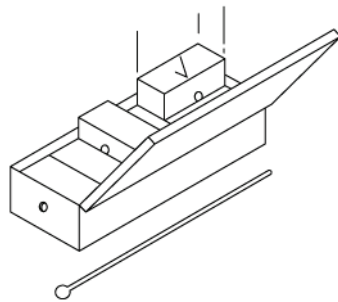

2

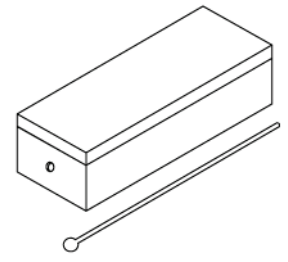

3

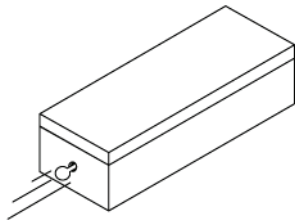

4

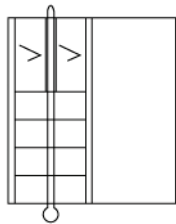

5

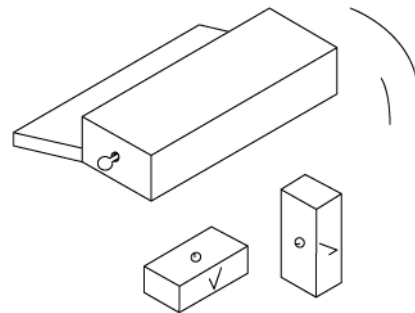

# Trick 5: Magic Floating Card Tricks

## The Sticking Card Trick

**OBJECTIVE:** Amaze your audience by having one card appear to stick to another card.

### SETUP:

Find the playing card that has three hidden wires on the back side (you should be able to see the hidden wires when you slightly bend the card upwards). You will also need one other regular playing card.

### INSTRUCTIONS:

1. Slightly bend the card with the three hidden wires upwards so the wires lift off the card.
2. When the card is bent upwards with the wires elevated, take the other playing card and slide it under all three wires.
3. Lower the hidden wires by releasing the upward bend (the card with the wires should go back to its normal flat state). This allows the hidden wires to be holding the regular playing card.
4. Turn the cards upside down, it appears to your audience that the cards are now stuck together
5. To make the cards to no longer stick together: slide the regular playing card back out the same direction you put it in.





1

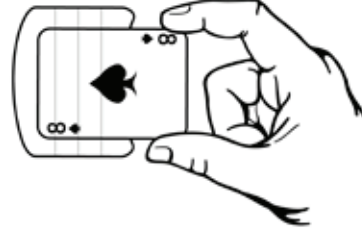

2(upper view)



3(upper view)



4

5

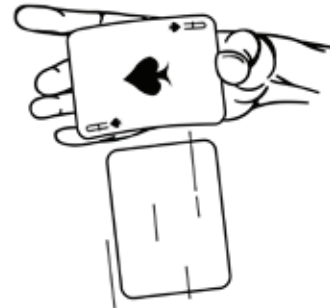

# Trick 6: Magic Floating Card Tricks

## Make an Object Float Trick

**OBJECTIVE:** WOW your audience by making an object appear to be floating all by itself!

**SETUP:** Find the playing card that has three hidden wires on the back side (you should be able to see the hidden wires when you slightly bend the card upwards) and another small lightweight object (ex. A small stick) that will be used as the object you make float.

### INSTRUCTIONS:

1. Take the playing card with the hidden wires in your hand -the wires facing you, place the small lightweight object to float on top. The object should be in the middle of the card, allowing it to lay across all three of the hidden wires.
2. Now with great concentration you will make the object float by slightly bending the card upwards so the wires lift off the card. The wires should hold the object up so it appears to be floating in the air all by itself to your audience.
3. To lower the object back down, slowly unbend the card so it is flat again which lowers the wires and brings the object back down.

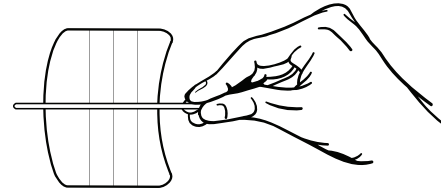
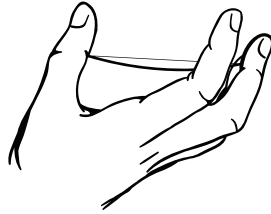

(upper view)

1

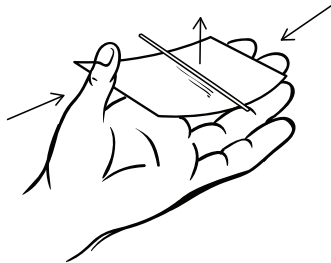

2

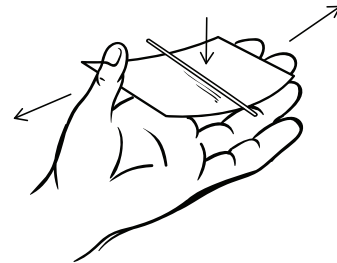

3

# Trick 7: Magical Mind Reading Trick

**OBJECTIVE:** Imagine being able to make your audience believe that you have the power to read minds & make cards disappear before their very eyes!

**SETUP:** Find the four face cards that are double suited (Half the card is one suit and the other half is another ex: Queen of Hearts & Queen of Diamonds) and a Jack of Hearts card.

## INSTRUCTIONS:

1. Fan the cards out in your hand so your audience can see the top corners of the cards. Make sure you place the Jack of Hearts card closest to the audience and in a way that it covers up the differences in the other cards.
2. Ask a member from the audience to look at the cards, pick a card, and remember the card by its color, suit, and face (King, Queen, Jack, Ace, etc)
3. Tell the audience member “Think very hard about your card. I am going to read your mind to figure out the card you picked and make it disappear.”
4. Close the fan of cards so they are in a single stack with the red backs of the cards facing you and the face of the cards are down. Wave your other hand over the cards while you are rotating the deck of cards and saying some magical words. (Abracadabra! Hocus Pocus! etc.)
5. Now show the cards again, when you fan the cards back out, the Jack of Hearts should still be the closest to your audience but the opposite half side of the other cards (with a different suit) should be showing. Since the cards have two suits on the front side, all the cards except the Jack of Hearts should appear be different.
6. Ask the audience member “Do you see your card?”
7. If they reply “yes”- reply “Your card is the Jack of Hearts.”
8. If they reply “no”- reply “I have successfully made it disappear”

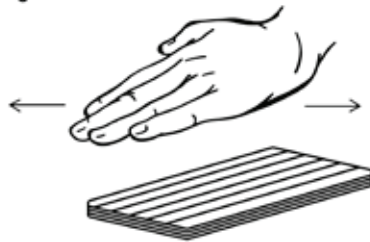

# Trick 8: Coin Case

## OBJECTIVE:

Make money disappear, transform, and multiply for your audience.

## SETUP:

The coin case that comes in your kit, and three different coins (penny, dime, & quarter). The case is designed to make a coin vanish when the inside tray section is inserted one way, and appear when the inside tray is inserted the other way.

## INSTRUCTIONS:

### PART 1: MAKE A COIN DISAPPEAR:

1. Hand the case and inside tray to a member of the audience.
2. Ask the audience member to place a coin (penny) inside the coin slot on the tray and slide it into the case.
3. Ask them to open it again and see if the coin is still there- it will still be there.
4. Now take the box, look inside and rotate the tray around (without the audience seeing).
5. Slide the tray back into the case.
6. Tap the box, and pull the inside tray back out. The coin has vanished (it is actually in a hidden chamber of the tray)

### PART 2: MAKE A COIN TRANSFORM INTO ANOTHER COIN:

1. Make a coin disappear by following the steps above in Part 1.
2. Then take a second coin (dime) and place it in the empty coin slot of the tray.
3. Rotate the tray and place the other end into the case.
4. Slide the tray into the case.
5. Pull the inside tray back out. The coin (dime) has now automatically transformed into the original coin (penny) that disappeared in Part 1.

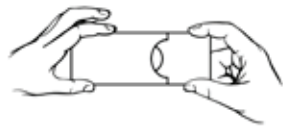

1

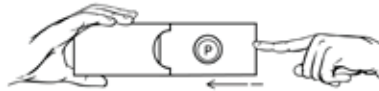

2(viewer action)

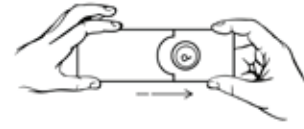

3(viewer action)

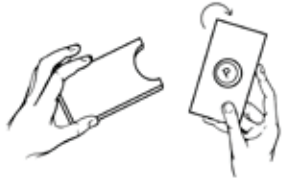

4

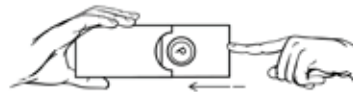

5

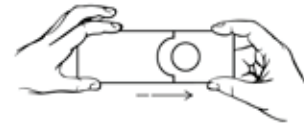

6

Follow Part 1: Make a coin disappear



1

2



3

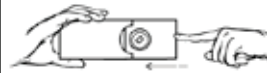

4

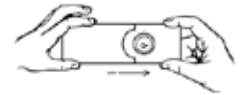

5

## Continuation:

# Trick 8: Coin Case

### PART 3: MAKE MONEY GROW:

1. Follow Parts 1 & 2. But this time before you perform the tricks make sure to have a third coin (quarter) hidden in your hand the whole time.
2. Take the coin (from the end of Part 2-penny) out and place it on a table.
3. Now you are going to rotate the tray again. When you do this, you are going to take your hand that has had the coin (quarter) in it and cover the tray allowing you to place the hidden coin into the coin slot on the tray. Do not allow your audience to see the coin (quarter)- you can hide it by keeping that hand over the tray as you slide it into the cover.
4. Slide the tray into the cover and back out of the cover, revealing the coin (dime) that was hidden in Part 2.
5. Take the coin (dime) out and place it on the table.
6. Rotate the tray around again and insert it back into the case.
7. Pull the tray out and it should reveal the third coin (quarter).



Trick 8: Coin Case. Part 3: Make money grow

Follow Part 1 (Make a coin disappear) &  
Part 2: Make a coin transform into another coin

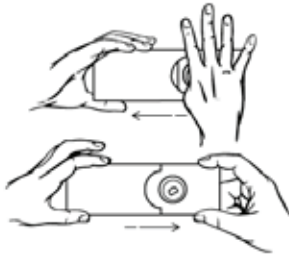
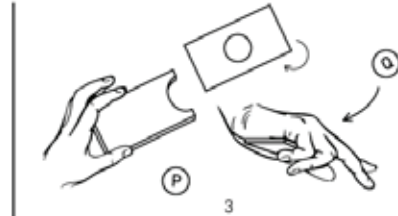
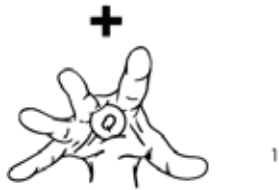

4

5

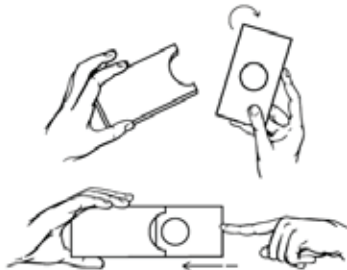

6

7

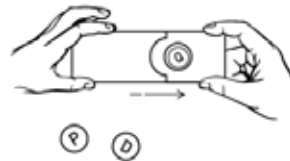

# Trick 9: Coin Cup

## Make a Coin Disappear

### OBJECTIVE:

Make money vanish right in front of your audience!

### SETUP:

The magic cup (which includes a stand, a false cover, and a real lid) that can be found in your kit and a coin. This trick requires practice before!

### INSTRUCTIONS:

1. Set up with the false cover already on top of the stand.
2. Place the coin on top of the false cover.
3. Then place the real lid on top of the coin, false cover, and stand.
4. Push down on the real lid gently so the false cover snaps into the real lid.
5. When you pick up the lid the false stand should have lifted into the lid. The coin is now in between the false cover and the lid. Be careful not to turn the lid because the coin will make noise inside the lid- giving your trick away!
6. To your audience it should appear that the coin has disappeared.

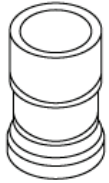

1



2

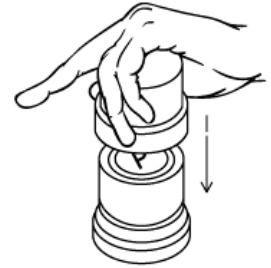

3



4

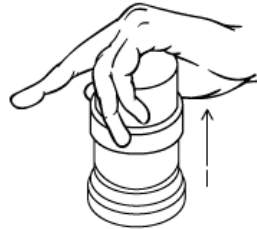

5

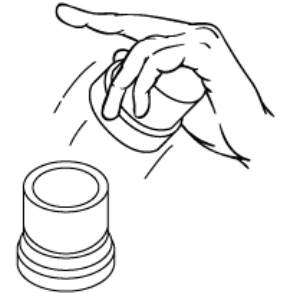

6

# Trick 10: Coin Cup

## Make Money Change Value

### OBJECTIVE:

Transform the value of your money right in front of your audience!

### SETUP:

The magic cup (which includes a stand, a false cover, and a real lid) that can be found in your kit and two different coins (penny & dime). This trick requires practice before!

### INSTRUCTIONS:

1. You will need to set the stand on the table, then place a coin (penny) on top of the stand. Next, place the false cover on top of the coin on the stand. Next, place a second coin (dime) on top of the false cover. This should be the only coin visible to your audience.
2. Push down on the real lid gently so the false cover snaps into the real lid.
3. When you pick up the lid the false stand should have lifted into the lid. The coin is now in between the false cover and the lid. Be careful not to turn the lid because the coin will make noise inside the lid- giving your trick away!
4. To your audience the hidden coin (penny) that was on top of the stand will be visible.

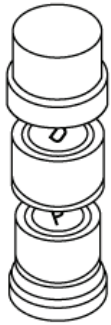

1



2



3



4



# Trick 11: Coin Cup

## Multiply Your Money

**OBJECTIVE:** Multiply the value of your money right in front of your audience!

**SETUP:** The magic cup (which includes a stand, a false cover, and a real lid) that can be found in your kit and three different coins. This trick requires practice before!

You will need to set the stand on the table, then place a coin (dime) on top of the stand. Next, place the false cover on top of the coin on the stand. You will need one of the other coins (quarter) in your hand, so your audience does not know it is there. You will also need your Magic Wand!!

### INSTRUCTIONS:

1. Place the last coin (penny) on top of the false cover. This should be the only coin visible to your audience.
2. Then place the real lid on top of the coin, false cover, and stand. Push down on the real lid gently so the false cover snaps into the real lid.
3. Pick up the false cover, coin (penny), and lid together at the same time revealing one of the hidden coins (dime).
4. You are going to set the lid down so the top of the real lid is on the table. While you do this talk about what you are doing so the sound of the coin hitting the lid is not noticed.
5. Remove the coin (dime) from the stand, by turning the stand over and dumping the coin (dime) onto the table. While you are dumping the coin (dime) out put the coin (quarter) hidden in your hand into the bottom of the stand. Show the audience that there is nothing on the table.
6. Turn the stand back over. Do so quickly and away from your audience so the coin (quarter) that you just placed in there is not visible. The coin should now be underneath the stand.

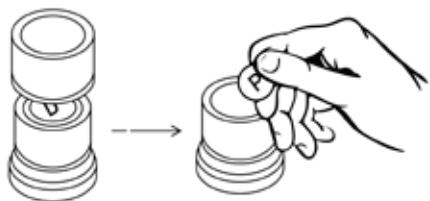

1

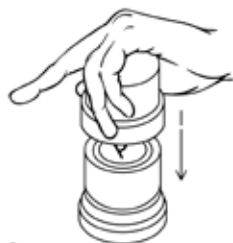

2

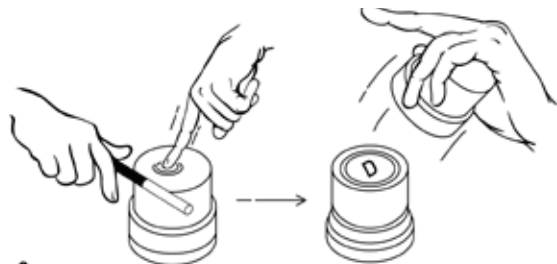

3



4

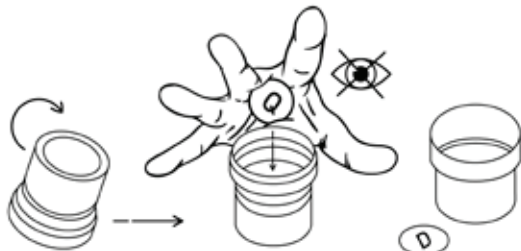

5

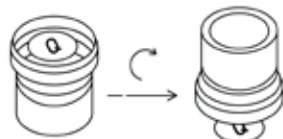

6

## **Continuation:**

# **Trick 11: Coin Cup**

## **Multiply Your Money**

7. Cover the stand with the real lid and with the false lid.
8. Now remove the cover, leaving the false lid on the stand, revealing the coin (penny) that was hidden in the cover.
9. Take the penny out and place it on the table.
10. Place the cover back on give the stand a tap with your magic wand. Now lift the whole container revealing the last coin (quarter).



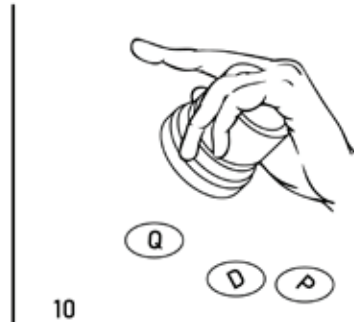
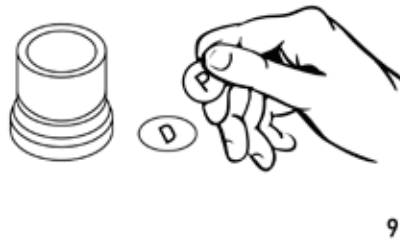
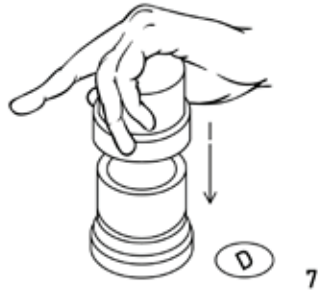

## Trick 12: Cups & Balls

### OBJECTIVE:

Have your audience believe you can make three balls move through cups and reappear from out of sight with the snap of your fingers.

### SETUP:

You will need three cups and four balls from your kit. The audience will only ever see three balls. Place one of the balls inside the cup before you start the trick. Then take one cup and stack it on top and the other cup on the bottom, so the cup with the ball is now the middle cup. The stack of cups should be upright as if you were to drink out of the cups.

### INSTRUCTIONS:

1. Place the cups one at a time on the table so each cup is upside down. Be careful when turning the middle cup so the audience does not see the hidden ball. To help avoid the audience seeing the hidden ball practice turning the cup toward yourself, with the mouth of the cup away from the audience as you place it down on the table.
2. Now place one of the balls the audience sees on top of the middle cup (B). And stack the other cups (A&C) on top of the cup with the ball on it. Do not move the middle cup because it has a ball hidden under it.
3. Snap your finger, and lift the cups up! This will reveal the ball the audience did not originally see. The audience will think you made the ball move to the bottom of the stack of cups.
4. Remember before continuing that there is still a ball in your stack of cups. Turn the stack of cups upright, so you are holding the cups as you would drink out of them.

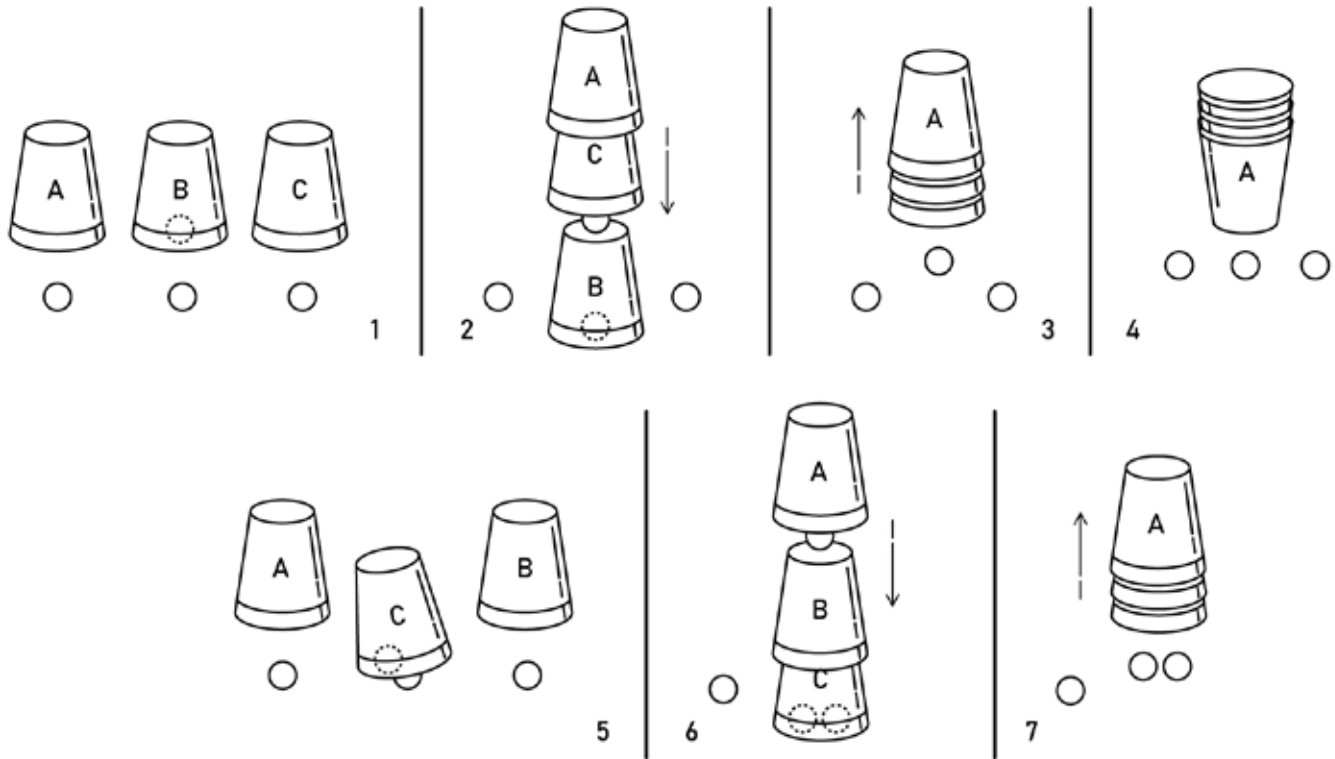

## Continuation:

### Trick 12: Cups & Balls

5. Now you are going to repeat the same steps (1-4). Place the cups one at a time on the table so the cup is upside down. Be careful when turning the middle cup so the audience does not see the hidden ball. The middle cup should go over the ball you just revealed to your audience. Now place one of the balls the audience sees on top of the middle cup (B). And stack the other cups (A&C) on top of the cup with the ball on it. Snap your finger, and lift the cups up! There should now be two balls revealed to the audience.
6. You will repeat steps (1-4) one more time. Place the cups one at a time on the table so the cups are each upside down. Make sure the middle cup goes over the balls you just revealed to the audience. Be careful when turning the middle cup so the audience does not see the hidden ball. Now place one of the balls the audience sees on top of the middle cup (B). And stack the other cups (A&C) on top of the cup with the ball on it. Snap your finger, and lift the cups up! There should now be three balls revealed to the audience.
7. To wrap up the trick- Take one of the balls you revealed and place it in your pocket or somewhere out of sight. Place the cups one at time on the table so the are each upside down again. Be careful when turning the middle cup so the audience does not see the hidden ball. When you place the middle one down it should now only be covering two balls, because the other is out of sight. Stack the other cups again on the middle cup. Snap your fingers, and lift the cups and it looks like you made the ball reappear from nowhere!

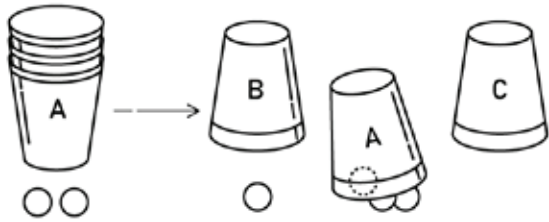

8

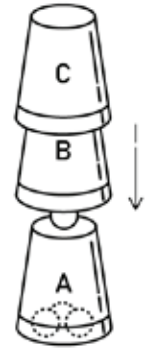

9

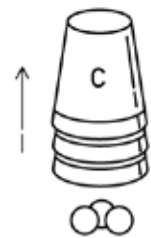

10



11

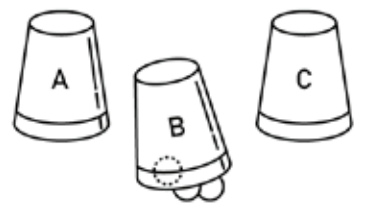

12

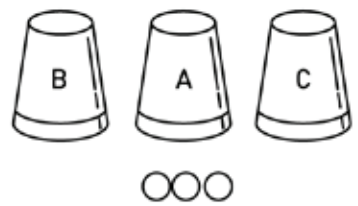

# Trick 13: Tube and Dice

## OBJECTIVE:

Surprise your audience when you read someone's mind with this dice trick.

## SETUP:

You will need the Little Tube with cover, the dice, and the big tube with cover from your kit. Lay all the pieces out on a table.

## INSTRUCTIONS:

1. Turn around and have someone from the audience pick a number on the dice, place the number face up in the little tube, and place the cover on the tube. Tell them to remember the number.
2. Once your audience member has finished, turn around. Now you have to come up with a story or reason to tip the container so the dice is up against the cover. Something like- the dice cannot get out of the container because the lid is on or there is nothing on this side or the other side of the container.
3. When the dice is touching the cover you should be able to see the dots and determine the number your audience member picked.
4. Place the little tube in the big tube with the cover. Let the audience member check out the tube.
5. Tell your audience member you are going to read their mind. Pretend to focus on reading their mind.
6. Tell them the number they picked.
7. Take the little tube out of the big tube, and take the lid off and show the audience you are a mind reader!

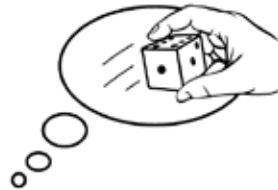
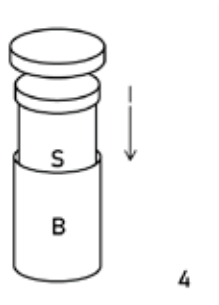
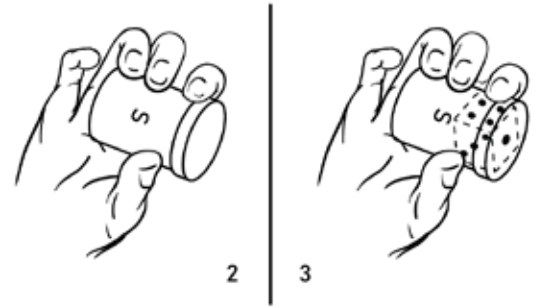
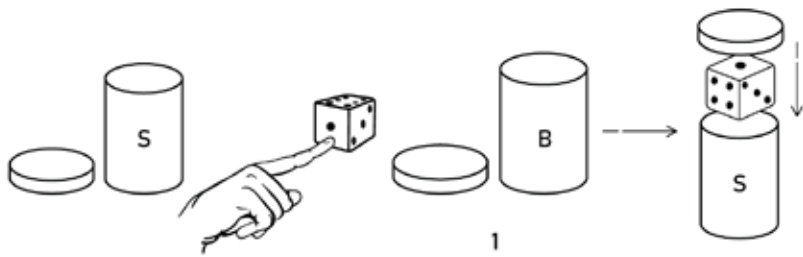

# Trick 14: Emotion Box

## OBJECTIVE:

Shock everyone when you read the emotion of your audience member.

## SETUP:

Locate the emotion cube with three emotions happy, angry, and sad. You should also have a box that the cube fits into. The emotion dice has slightly different heights depending on which emotion is up. When the dice is placed in the box, the lid will either be a little raised, flush with the base, or the base will go slightly further into the lid. Before performing this trick, you will need to memorize which face produces which fit of the lid.

## INSTRUCTIONS:

1. Take the dice and dice box and show it to your audience.
2. Pick an audience member to help you with your trick.
3. Turn around and tell your audience member to pick an emotion on the dice and place the emotion face up in the box and cover the box. Once they have done that, you may turn back around.
4. Now you will reveal the emotion they selected, to do this you have to determine how the lid fits on the base.
5. If the cover is raised- the emotion is HAPPY
6. If the cover is not raised and flush with base- the emotion is ANGRY
7. If the cover's edge extends passed the base- the emotion is SAD



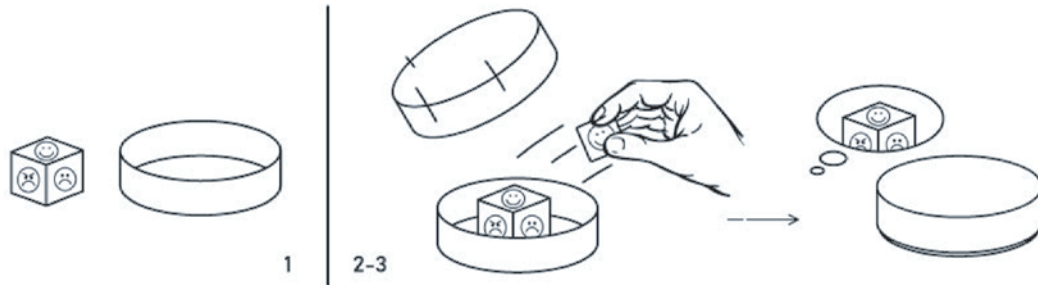

# Trick 15: Escaping Coin

**OBJECTIVE:** With a little bit of practice you will astound your audience by making a coin escape from a secured case!

**SETUP:** Find the escaping coin case (made of three pieces of plastic- 1 hard red piece and 2 clear, bendable pieces), scarf, and four rubber bands supplied in your kit. You will also need a single coin. Your magic wand is also needed! This trick requires practice!

## INSTRUCTIONS:

1. Assemble the case by placing one piece of clear, bendable plastic on the bottom, then the hard, red plastic piece on top of the clear plastic piece. Next, the coin goes on top of the bendable plastic piece in the hole in the center of the red piece as shown. Lastly, place a clear, bendable plastic piece on top of the coin. It should create a sandwich- looking structure.
2. Now to hold the case together, you will place four rubber bands around the plastic. You should put one around each side of the case so all four sides are secured.
3. Lightly shake the case to show your audience that the coin is in the case.
4. Now place the case with the coin inside, on the scarf. When you wrap it into the scarf make sure you wrap it in a way that one of the ends of the scarf is open.
5. Pick up the scarf with the case inside and squeeze the sides of the box between your thumb and finger. While squeezing the case, tilt the scarf with the case to one side. The coin should slide out the side, into your hand. This should not be noticeable to your audience. You will now keep the coin hidden in your hand for the rest of the trick.
6. Continue to fold up the scarf. Place it back on the table all wrapped up.
7. Tap it with your magic wand, say your magic words, wave your hands so it appears you are doing magic.
8. Now you, or an audience member, can unwrap the scarf and reveal the coin has disappeared.
9. Add-on: You can find the coin (which is still in your hand), in someone's pocket or behind their ear!

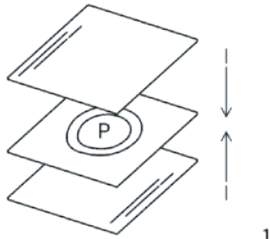

1

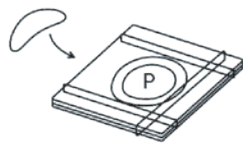

2



3

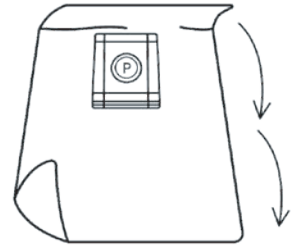

4

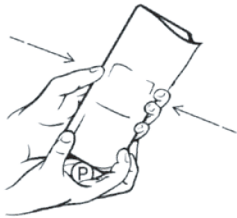

5



6



7

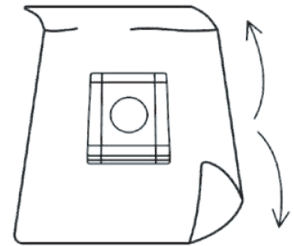

# Trick 16: Finger Chopper

## OBJECTIVE:

With a little bit of dramatics you will have your audience believing you have chopped your finger off!

## SETUP:

Find the Magic Finger Chopper in your kit- it is red and yellow. This trick is about being dramatic in order to make your audience believe you are in pain and have just chopped your finger off!

## INSTRUCTIONS:

1. Show your audience how the blade moves up and down on the finger chopper by pulling the yellow blade up and down.
2. When you are ready to perform the trick- Make sure the blade part is up and place your finger through the hole located in the center of red finger chopper part.
3. Now push the blade down onto your finger. Make sure to “sell” this to your audience by reacting like your finger has just been chopped off!! The blade will go around your finger and not actually cause any harm.
4. After a few moments, lift the blade up and slowly remove your finger to show that it has not been harmed.

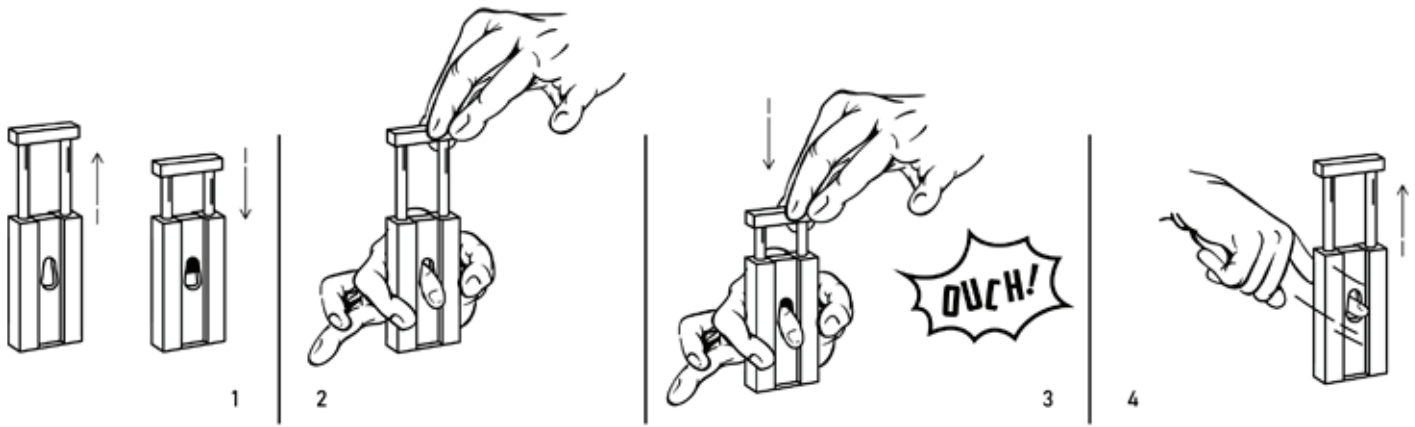

# Trick 17: Frame Tricks

## OBJECTIVE:

You will shatter your audience but not the frame in this trick, when you force a nail through a solid frame.

## SETUP:

Magic Frame, plastic nail (one of the yellow spikes from the set), and a playing card all included in your kit. The frame has a clear plastic insert which can be locked and unlocked.

## INSTRUCTIONS:

1. Take the magic frame and tap the frame with a plastic nail to show that it is solid.
2. Take a playing card and pass it into the frame behind the center band in the frame.
3. The clear plastic insert in the frame should unlock when pushing the card behind the center band frame and then the clear part can be pushed aside with a finger. (If the clear part doesn't slide, flip the frame over and repeat step 2).
4. Now you can take the nail and force it through the hole in the center of the hole in the frame and through the card.
5. Now remove the nail and the card. Quickly and secretly slide the clear piece back so the hole is once again hidden. Show your audience that there is a hole in the card. Retap the frame to show the audience it is still intact and solid.

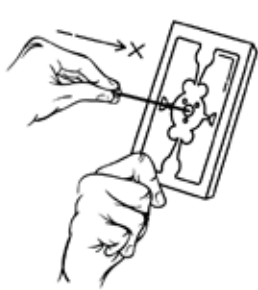

1

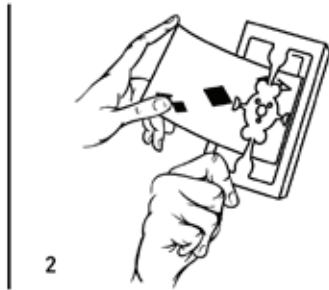

2

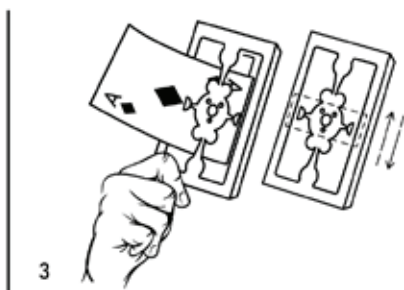

3

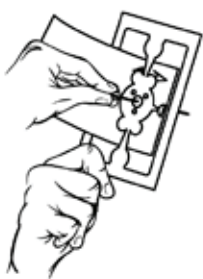

4

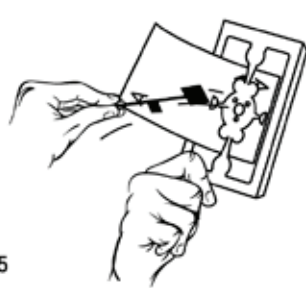

5

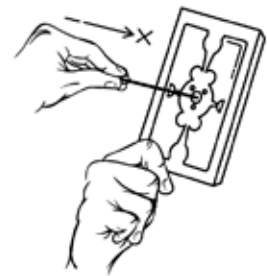
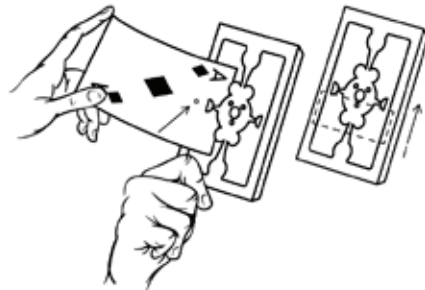

## Trick 18: Growing Cards

**OBJECTIVE:** Through an optical illusion you will have your audience wondering how you made cards grow in size.

*What is an optical illusion? When we see something it is processed by the brain. The brain then takes that image and tries to make sense of it. Sometimes the brain is tricked to see something that is not the true image or not even there. When this happens it is called an optical illusion.*

**SETUP:** Find the two Magic Growing Cards (they are the same size) in your kit, one card is orange and one card is green.

### INSTRUCTIONS:

1. Start by having the cards lay on top of each other so your audience can see that the cards are the same size.
2. Tell your audience you are going to make the cards grow. Make an elaborate story (example: hypnotism, force fields, stretching, etc.) to go along with your trick.
3. Now take the cards and separate them so they are now next to each other with one card in each hand. When you do this, make one of the cards be slightly lower, closer to the ground, than the other. Whichever card is lower will appear to be smaller to the eye.
4. Ask your audience, “Which card appears to be bigger?”
5. You can put the cards back on top of each other again to show how you can shrink the bigger card back to be same size as the other card.

### **WANT TO MAKE THE OTHER CARD APPEAR TO BE BIGGER?**

You can make the opposite card appear to be larger this time by separating the cards again so they are again next to each other. When you do this, make sure the card you want to appear to be bigger is slightly higher than the other card.



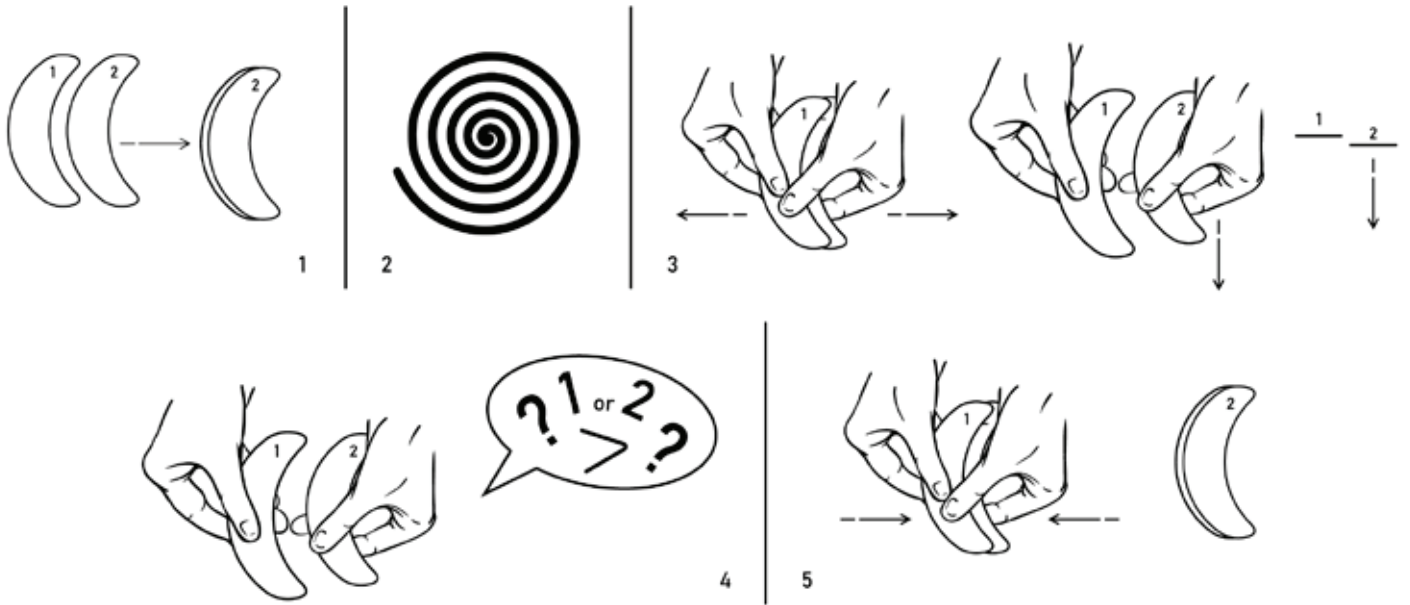

# Trick 19: Illusion Box

## Disappearing & Reappearing Card

### OBJECTIVE:

Through illusion you will make a card disappear and reappear.

### SETUP:

Locate the Illusion Box in your kit. The Illusion box is purple and has a flap insert that serves as a false bottom. You will also need a playing card for this trick. Before your trick you will need to insert the flap, false bottom, into the box.

### INSTRUCTIONS:

1. Open the illusion box and place a playing card on the opposite side of the false bottom.
2. Close the illusion box.
3. Flip the illusion box over so the false bottom now covers the playing card.
4. Open the illusion box. It appears to your audience the card has disappeared, but it is hidden under the flap.

**TO MAKE IT REAPPEAR:** Close the lid again, and flip the box back over. Open the box and the card has reappeared.

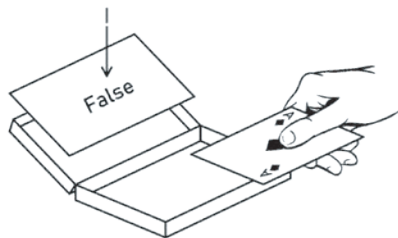

1

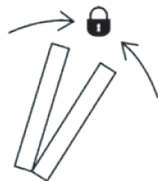

2

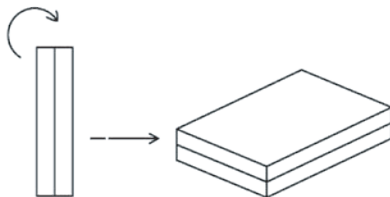

3

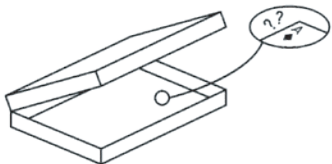

4

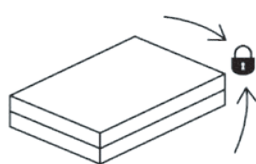

5

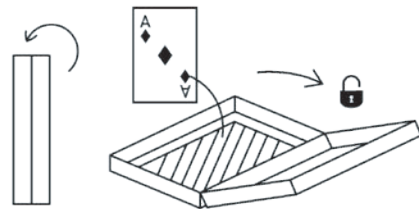

# Trick 20: Illusion Box

## Transformation of an Object

**OBJECTIVE:** Through illusion you will make one object turn into another.

**SETUP:** Locate the illusion Box found in your kit. The Illusion box is purple and has a flap insert that serves as a false bottom. You will also need two similar objects (Recommended: two different playing cards, or two different monetary bills, two different colors of paper). Before the audience sees, you need to place one of the objects under the false bottom of the illusion box.

### INSTRUCTIONS:

1. Before the audience sees you need to place one of the objects under the false bottom of the illusion box and close the box.
2. Show your audience the other object (bill or card).
3. In front of your audience open the illusion box. To the audience the box should appear empty.
4. Place the object you are going to transform into the illusion box opposite of the false bottom.
5. Close the illusion box so the false bottom falls on top of the object you just placed in the box. The false object will now cover the object you placed in the box in front of your audience and reveal the object you had previously hidden.
6. Open the illusion box and show your audience the new object.
7. You can make the original object appear by closing the lid again so the false bottom shifts to the other side and revealing the other card. Open the illusion box up revealing the original object.

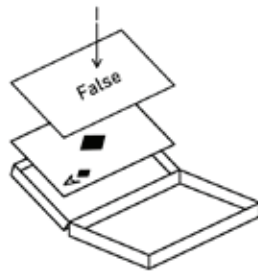

1



2

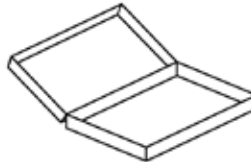

3

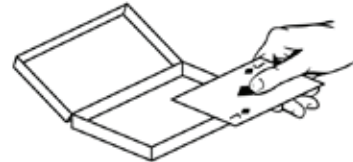

4



5

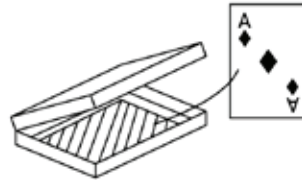

6

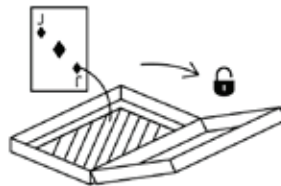
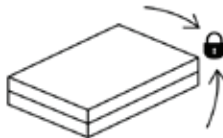

7

# Trick 21: Illusion Box

## Make an Object New Again

**OBJECTIVE:** Through illusion you will take a destroyed object and make it brand new.

**SETUP:** Locate the Illusion Box found in your kit. The Illusion box is purple and has a flap insert that serves as a false bottom. You will also need two identical objects. For the objects pick an object you don't mind cutting up or ripping (Recommended: two pieces of paper). Scissors (optional). Before the audience sees you need to fold one of the identical objects (paper) and place under the false bottom of the illusion box.

### INSTRUCTIONS:

1. Before the audience sees, you need to fold one of the identical objects (paper) and put it into the illusion box, under the false bottom.
2. Ask a member of the audience to come up and rip/cut the other object.
3. Open the illusion box. To the audience the box should appear empty.
4. Ask your audience member to then place the pieces into the illusion box.
5. Close the illusion box and flip the box so the false bottom falls on top of the shredded objects you just placed in the box. The false bottom will now cover the object your audience member placed in the box and reveal the whole object you had hidden prior to the trick.
6. Take the whole object out and show your audience. Be careful not to reveal the pieces hidden in the box.

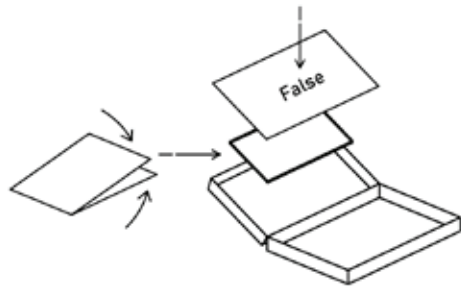

1

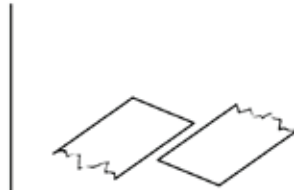

2

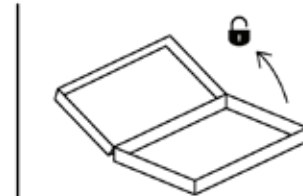

3

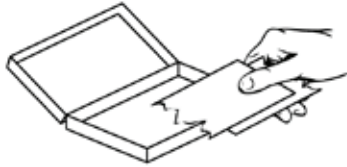

4

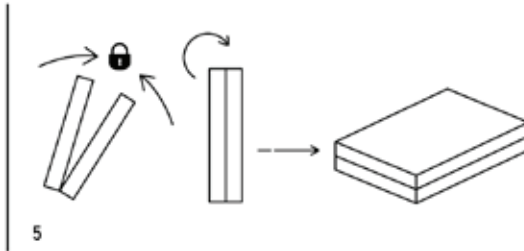

5

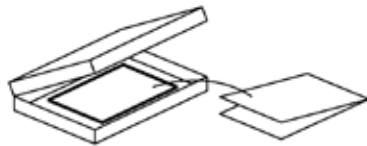

6

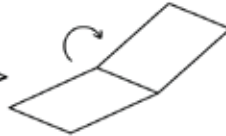

7

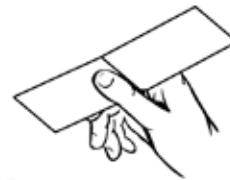

## Trick 22: Lightning Box

**OBJECTIVE:** Amaze your audience by making a coin disappear and teleport inside a locked box.

**SETUP:** You will need a coin, marker, seven rubberbands, bag, slide, the inside box, and outside box. There is a lot of prep before presenting to the audience. Take the little bag and slip it over the bottom of the slide. Take a rubberband and secure the bag to the slide by wrapping the rubber band around it. Then place the bag inside the inside box by laying it down with the slide facing out. Place the lid on the inside box. The slide should still be facing out. Wrap the inside box with two rubber bands in opposite directions to hold the top and bottom pieces together. Place the inside box in the outside box again with the slide facing out. Then wrap the outside box with four rubber bands around it to secure it. Then place the whole container out of sight but make sure the slide is accessible for you to slide the coin into.

### INSTRUCTIONS:

1. Make sure you have performed the set-up explained above before you have an audience.
2. In front of your audience, ask an audience member to mark the coin and so the audience knows the same coin throughout the trick.
3. Take the coin in your hand and pass it back and forth. Then pretend to press the coin into the palm of one hand with the other hand.
4. Pretend to close your hand over the coin and hold up the closed hand. You should actually keep the coin in the other hand.
5. While the attention of the audience is on the closed hand, the other hand will insert the coin into the slide sticking out of the hidden container. Make sure to keep your audience's attention on your closed hand.
6. Use some magic words and open your closed hand to show the audience the coin has vanished.
7. Then reach for the hidden container. When you reach for it remove the slide from the container by pulling down on the box and pulling the slide out. Do not allow your audience to see you removing the slide, keep the slide out of sight of the audience. Show the case to your audience that appears to be locked shut with rubber bands.
8. Have either yourself or an audience member unlock the container by undoing the rubber bands and boxes until they reach the bag which contains the coin. Ask an audience member to verify it is the same coin that you started with.



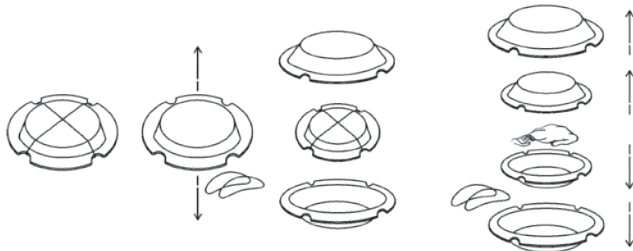
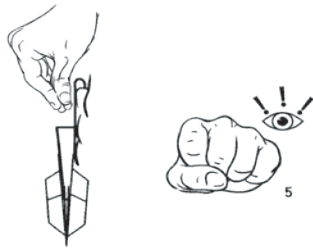
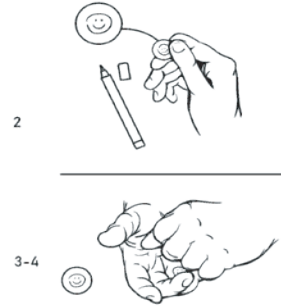
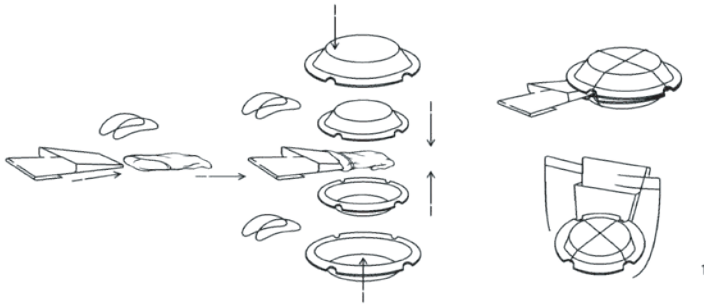

9

# Trick 23: Wand Out of Your Scarf

## OBJECTIVE:

Make a magic wand appear out of a scarf!

## SETUP:

You will need your Trick Magic Wand, and a scarf from your kit. The wand has one white tip that is able to slide. Pre-set the wand, with both white tips together. You will need to place the wand inside of your arm, up your sleeve before showing it to your audience. Keep one end of the magic wand in the palm of your hand (with both white pieces in the palm of your hand.)

## INSTRUCTIONS:

1. The trick magic wand should already be on the inside of your arm and up your sleeve with both white pieces in your hand. Take the scarf in your other hand and wave it around for the audience to see there is nothing inside. Tell the audience you are going to make a magic wand appear from the scarf.
2. Take the scarf and place it over the hand with the hidden magic wand. With your hand holding the scarf, grab one of the white ends of the trick magic wand and begin to pull it out of your hand so it is visible to the audience.
3. Take your time, slowly revealing the entire wand to the audience.



1



2



3



1

2

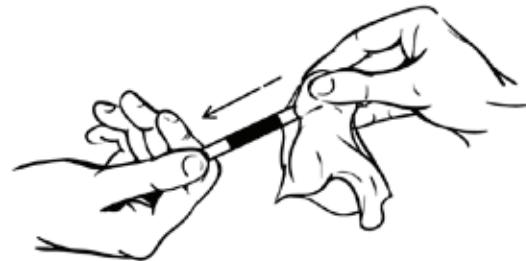

# Trick 24: Up Your Nose

## OBJECTIVE:

Make a magic wand go up your nose- and out your mouth!

## SETUP:

You will need your Trick Magic Wand from your kit. The wand has one white tip that is able to slide.

## INSTRUCTIONS:

1. Hold one end of the magic wand in one hand and with the other hand, hold the other end of the magic wand up to your face. While you do that, make sure you're covering the white tip that is closest to your nose.
2. And now, you will pretend that you're pushing the wand into your nose. Add some weird noises so your audience really believes that you're really sticking that wand up your nose!
3. But actually you will slowly push up the bottom white tip, and while you're doing that, the wand is slipping down your arm, covering the end of the wand.
4. Tell your audience that you will pull the wand out of your nose, through your mouth. To pull it out, move the magic wand down to your mouth. With one hand, over the white tip next to your mouth and with your other hand, slowly pull the other white tip down, so that you reveal the entire magic wand.



1

2



# Trick 25: Sticking into Stomach

## OBJECTIVE:

Stick a magic wand into your stomach!

## SETUP:

You will need your Trick Magic Wand from your kit. The wand has one white tip that is able to slide.

## INSTRUCTIONS:

1. Tell your audience that you will stick the magic wand into your stomach. Put the end of the wand on your stomach. Make sure that you're using your hand to cover the white tip on that end. Leave the other white tip exposed, so that the audience can see it.
2. You will pretend that you're pushing the wand into your stomach. You can yell "ouch!" or "grrrrr..." But actually you will slowly push up the exposed white tip, and while you're doing that, the wand is slipping down your arm, out of view from your audience.
3. To pull it out, and pull the white tip down, use your hand to cover the white tip on the end that's touching your stomach. Leave the other white tip exposed, so that the audience can see it. And now slowly pull the exposed white tip out, revealing the wand.

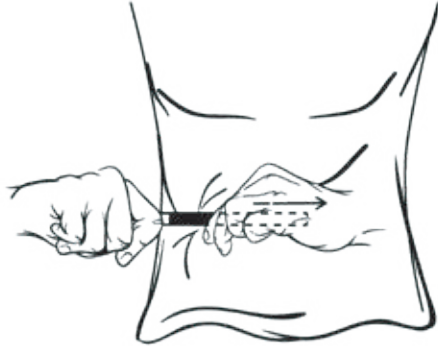

1

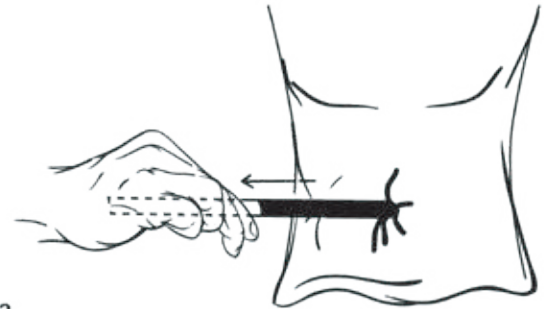

2



3

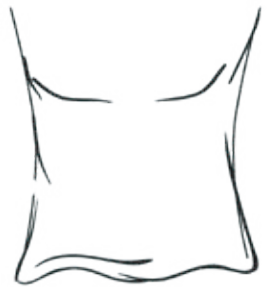

# Trick 26: Shrinking Magic Wand

## OBJECTIVE:

Make a regular wand shrink to be itty- bitty.

## SETUP:

Trick Magic Wand provided in your kit. The wand has one white tip that is able to slide.

## INSTRUCTIONS:

1. Take the wand and show it to your audience. Convince them that the wand is real by tapping it on the table, swinging it around, or trying to bend it.
2. Hold the wand in your hands with the white tips in the fingers of each hand. Concentrate your energy on the wand and trying to make it shrink. Make it seem like it is super difficult.
3. Begin to make the wand shrink by pushing the one white tip that is able to slide along the wand. The white tips should move together while the actual wand slides up your arm.



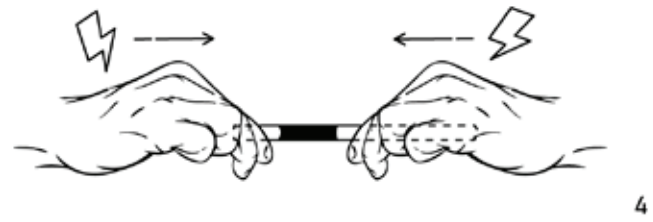
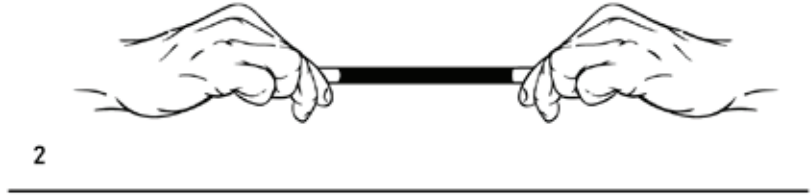
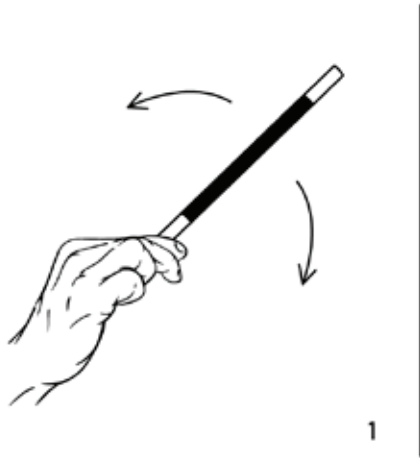

# Trick 27: Mind Reading Magic Box

## OBJECTIVE:

This magic box allows you to read the mind of an audience member and guess the animal they have picked!

## SETUP:

A red box with lid and a cube with six different animals on it can be found in your kit. You will also need a good story to go with this trick so make sure to practice before!

## INSTRUCTIONS:

1. You will turn around so your back is to the audience member and the cube. Ask an audience member to pick an animal on the cube. Then have them put the animal they have picked face up in the box and cover the box with the top when they are finished. Ask them to tell you when they have finished so you can turn around.
2. Once they have finished and told you to turn around, turn around. Pick up the box and tell your story. Our suggestion is one about different animals that are on the cube or maybe put the box up to your ear to try and hear what sound the animal makes that the audience member picked, etc. Something to distract your audience from seeing the next step.
3. While you are telling your story pick up the cover of the box and move it to another side of the box without your audience seeing. This will reveal the dice so you can see the animal the audience member picked. To your audience it looks like the cover is still on the box.
4. Reveal what animal the audience member selected.

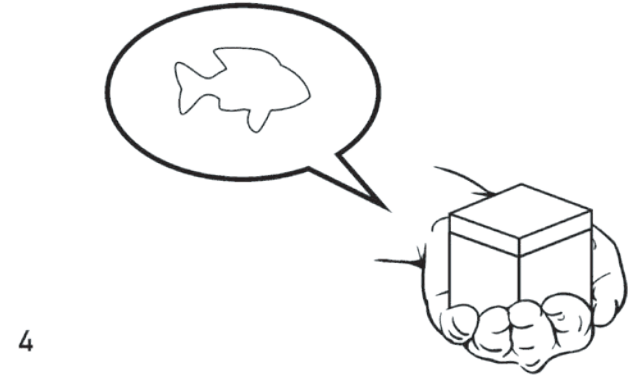
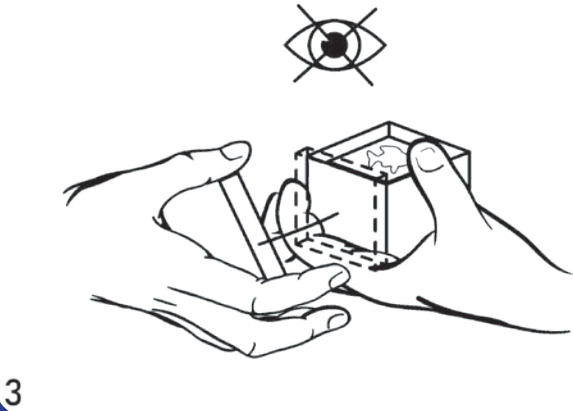
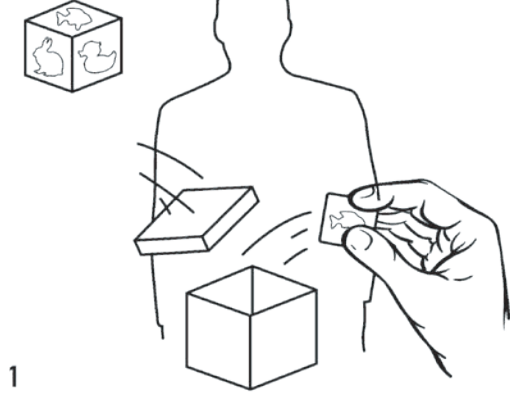

# Trick 28: Mystery Spinner

## OBJECTIVE:

A spinner that will always select the number your audience selected.

## SETUP:

Dice and spinner from your kit.

## INSTRUCTIONS:

1. Ask a member of your audience to come forward and examine the dice and roll the dice. If you do not have a dice you can ask a member to pick a number from 1-6.
2. Once the audience member has decided the number pick up the spinner to set it. The spinner has a button on the bottom point, and weight inside of it that you will need to move to the number you would like it to land on. Push down the top and bottom point button (do not show the audience this button!) and rotate the spinner so the number you would like is downward. This allows the weight to shift to the number you want.
3. Once you have it selected release the bottom to lock the weight in the space.
4. Now spin the spinner. The weight will allow it to land with the number you want on the bottom (against the table).
5. Show your audience that the spinner has magically detected and shown the secret number!



1



4



2



3



5

# Trick 29: Ring Coin

## OBJECTIVE:

Make a coin disappear.

## SETUP:

Two metal rings: one is plain and the other one has a solid black center. A black mat (in your kit), a coin, and a card (in your kit) are also needed. Start with all objects on top of the mat on a flat surface before your audience is present. You may need to adjust the lighting so the ring blends in with the mat.

## INSTRUCTIONS:

1. Start with the metal rings, and coin on top of the mat. Show the audience the ring with the empty center to make them believe both rings are plain. Do not pick up the ring with the solid black center.
2. Place the card over the ring with the solid black center. The card will hide the solid center from your audience.
3. Pick up the ring with the solid center & the card, and place them on top of the coin.
4. Wave your magic wand.
5. Pick up the card to reveal to your audience that the coin has disappeared. In fact, the coin is under the black center of the ring.

## TO HAVE THE COIN REAPPEAR:

Place the card back on top of the solid ring.

Pick the card and solid ring back up, revealing the coin.

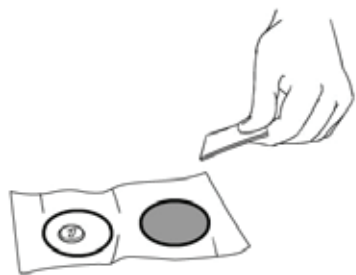

1



2

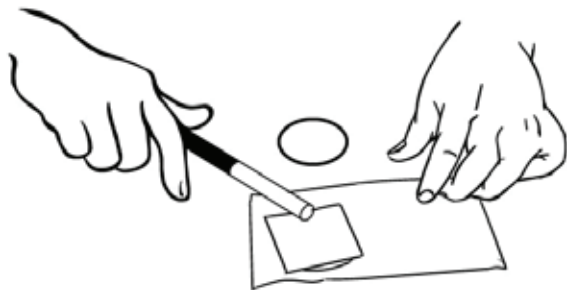

3

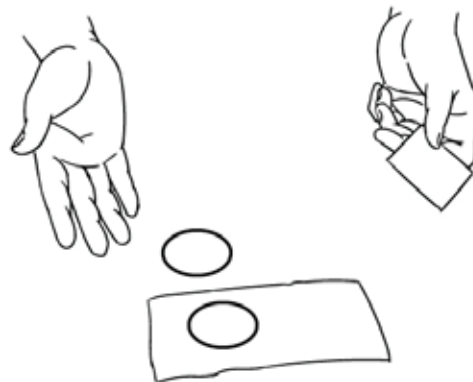

4

# Trick 30: Dove Couple

## OBJECTIVE:

Two dove that magically always end up back together.

## SETUP:

Find the 2 large foam doves in your kit. You will need to practice this trick before hand. Practice pretending to move the dove from one hand to another by hiding the doves by squishing them in between your little finger, third finger, and your palm (this is known as “palming”).

## INSTRUCTIONS:

1. Take one of the large doves in your hand and bring your hands together. Palm the dove, by squishing it into the other hand between your little finger and third finger without your audience noticing. Make it appear that you put into the opposite hand, in reality it is hidden in the hand that was originally holding it. Close both hands. Then point to your empty hand, so the audience believes you have placed it in that hand.
2. With your empty closed hand, that the audience believed the dove is in, pretend to put the dove in your pocket. Reveal the hand is empty so it appears you placed the dove in your pocket.
3. Pick up the second dove with the hand that is holding the first dove. Put the dove in your hand containing the first dove, closing your hand around both doves.
4. Say how the doves love to be together and how you think the one in your pocket somehow made its way back to the other dove.
5. Reveal that the two doves are in your hand.





# Trick 31: Dove Family

**OBJECTIVE:** Create a little dove family from two parent doves!

**SETUP:** Find the magic dove family, 2 large foam doves (parents) and 3 smaller foam doves (babies), found in your kit. Before your audience sees, place the baby dove out of sight but is accessible- in your pocket or hidden somewhere nearby. You will need to practice this trick before hand. Practice pretending to move the dove from one hand to another by hiding the dove by squishing them in between your little finger, third finger, and your palm (this is known as “palming”).

## **INSTRUCTIONS:**

1. Take one of the large dove in your hand. Bring your hands together and palm it into the same hand that was holding it without your audience noticing. Make it appear that you put into the other hand. Pretend to put the empty hand, that the audience believes the dove is in, in your pocket. Reveal the hand is empty so it appears you placed the dove in your pocket.
2. Pick up the second dove with the hand that is holding the first dove. Put the dove in your hand containing the first dove and close your hand around both dove.
3. Say how the doves love to be together and how you think the one in your pocket somehow made its way back to the other dove.
4. Reveal the two doves are in your hand. While you are revealing this pick up the three baby doves and palm them in your other hand. Your audience is distracted with the two doves you revealed that they should not notice you doing this. Talk to the audience about the dove couple wanting to have a family.
5. So we repeat the same trick again: Pick up one of the big dove from the table and pretend to pass it to your other hand and place the dove in your pocket. Now pick up the second dove with the same hand holding the first dove. Hold out both hands to the audience and asks them how long they think the doves can be apart. Then open your hands and reveal the dove family, two big doves and three babies!

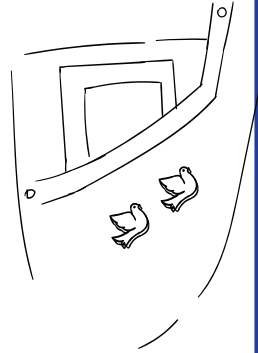
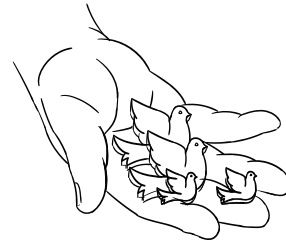
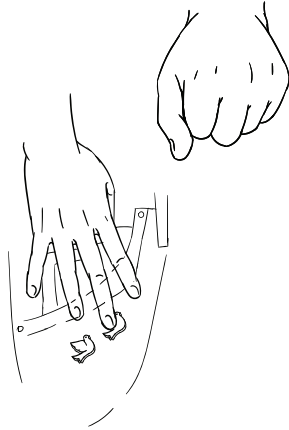
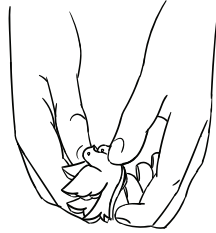
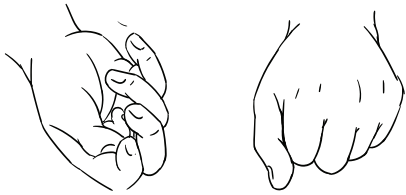
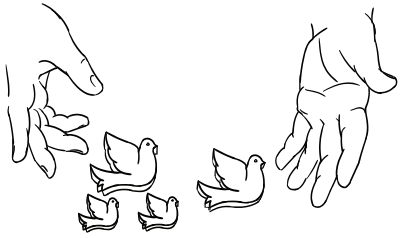

# Trick 32: Rope Cutter

## OBJECTIVE:

Slice a rope in half and put it back together again.

## SETUP:

Find the magic rope cutting box and rope supplied in your kit.

## INSTRUCTIONS:

1. Pass the rope through the hole in the top of the cutting box.
2. Explain that the box is a magic box and that you are going to cut the rope in half.
3. Slide the box sideways to move into two parts. The rope appears to be cut in half.

## TO PUT THE ROPE TOGETHER AGAIN:

4. Slide the two halves back together again.
5. Then pull the rope out showing your audience the rope is whole again.



1



2



3

## Trick 33: Rope Tricks: Changing Lengths

### OBJECTIVE:

Change the lengths of three ropes right in front of your audience.

### SETUP:

Find the three ropes of different lengths: short, medium, and long supplied in your kit.

### INSTRUCTIONS:

1. Pick up the ropes one at a time and place them inside your hand so they are hanging so the audience can see their different lengths. The shortest rope should be placed closest to your thumb, then the medium rope, then the longest rope on the outside.
2. Now pick up the end hanging down of the shortest rope, and bring it up to your hand holding the ropes. With your hand blocking this from your audience place the end of the short rope over the middle rope and under the long rope. Then take the short ropes end and bring it up. The short ropes end should now be between the top of the short and medium rope.
3. This should of created a loop around the long rope. Release the long ropes top that was in your hand and pull it down. So that it becomes even with the ropes hanging down. The loop should be hidden by your hand. It looks to your audience that the lengths of the three ropes have changed to be the same length.
4. To undo the trick:
5. Take one of the ends of the long string that is hanging down and bring it back up to the top and place it in your fingers where you are holding the other ends.
6. Take the end of the short rope and release it from your hands so it will eventually hang back down. Give the ropes a shake and the ropes should come back to their original way.

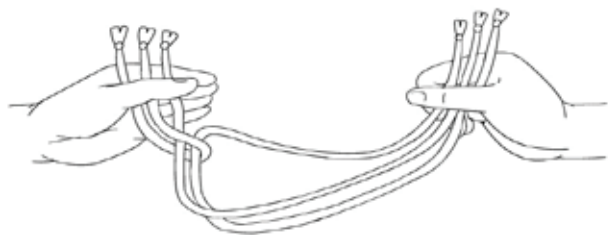
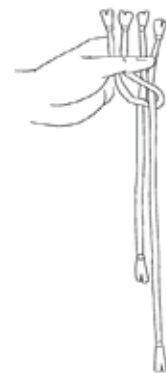
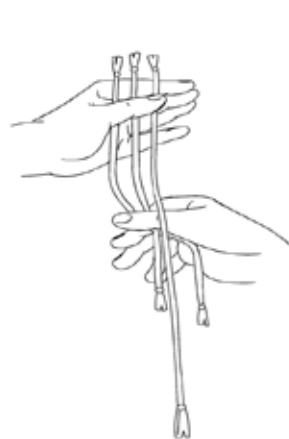

# Trick 34: Rope Tricks

## Single Handed Knot

### OBJECTIVE:

Tie a knot with one hand.

### SETUP:

You will need the medium rope for your kit. You will need to practice this trick beforehand.

### INSTRUCTIONS:

1. Hang the rope over the backside of one of your hand with one end hanging between your thumb and fingers.
2. The side hanging between your thumb and fingers needs to go behind the other rope side. To do this use your thumb to push it over. Grab it between your third (ring) and fourth(little) finger.
3. Tilt your hand so the other side of the rope can be picked up between your first (index) and second (middle) finger.
4. Holding the rope tightly between your first (index) and second (middle) finger let the rope slide down your hand over your fingertips.
5. The rope should fall off your hand leaving a knot in the rope.



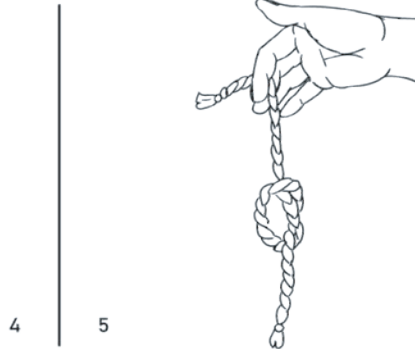
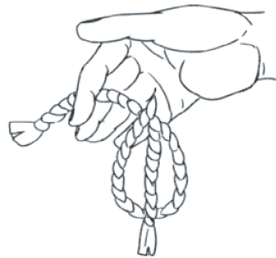
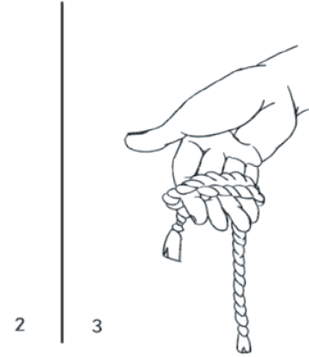
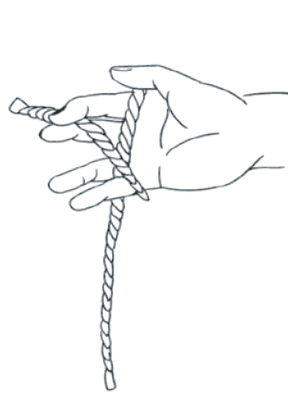
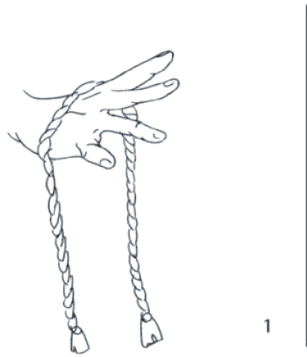

# Trick 35: Scarf Tricks

## Disappearing & Reappearing Scarf

### OBJECTIVE:

Allude your audience to believe the scarf has vanished into thin air and then reappeared.

### SETUP:

Find the fake thumb tip and scarf supplied in your kit. Place the false thumb on before performing this trick in front of your audience. This trick requires practice. You must be able to hide the false thumb from view as much as possible or your audience will catch on.

### INSTRUCTIONS:

1. Place the false thumb on before performing this trick in front of your audience. Show the scarf to the audience. You want your audience's attention on the scarf so they do not see the false thumb.
2. While the audience is looking at the scarf, place the false thumb in the center of your other hand and curl your fingers around it making a closed fist. Remove your real thumb leaving the fake thumb behind.
3. Start to slowly push the scarf into the false thumb inside your closed fist.
4. When the scarf is completely inside the false thumb, push the hand that was holding the scarf thumb into the false thumb. Put the false thumb onto your real thumb.
5. Now reveal your hands, and hide the false thumb from view by waving your hands around keeping the thumb closest to your body and further from your audience. To your audience it appears the scarf has vanished.

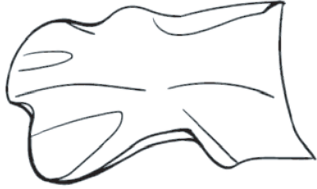

1



2



3



4



5

## **Continuation:**

# **Trick 35: Scarf Tricks**

## **Disappearing & Reappearing Scarf**

### **TO BRING THE SCARF BACK:**

6. Pull your real thumb out leaving the false thumb and scarf inside your closed fist.
7. Reach inside the closed fist and slowly start to remove the scarf.
8. Once the scarf is removed, place your thumb back inside the fake thumb and open your hand. Your audience's attention is on the scarf and not the fake thumb.
9. Quickly curl your thumb with the false thumb into your other open hand and close your hand over it.



6



7



8



9

# Trick 36: Scarf Tricks

## Transform into Another Object

**OBJECTIVE:** Deceive your audience to believe the scarf has transformed into another object.

**SETUP:** Find the fake thumb tip and scarf supplied in your kit. You will also need another small object such as a coin or folded bill. Place the false thumb on before performing this trick in front of your audience and the small object in the palm of the same hand. This trick requires practice. You must be able to hide the false thumb from view as much as possible or your audience will catch on. Place the false thumb on top of your own in preparation for the trick.

### INSTRUCTIONS:

1. Place the false thumb on before performing this trick in front of your audience and the small object in the palm of the same hand. Show the scarf to the audience. You want your audience's attention on the scarf not the false thumb.
2. While the audience is looking at the scarf, place the false thumb in the center of the hand holding the small object and curl your fingers around the false thumb, making a closed fist. Remove your real thumb leaving the fake thumb behind.
3. Start to slowly push the scarf into the false thumb inside your closed fist.
4. When the scarf is completely inside the false thumb, push the hand that was holding the scarf thumb into the false thumb. Put the false thumb onto your real thumb.
5. Now reveal your hand and that the scarf has turned into your small object.

### EXTENSION:

Place your hand wearing the false thumb into your pocket and leave the false thumb behind. Then pull the scarf out of your pocket so it appears to have moved from your hand to your pocket.

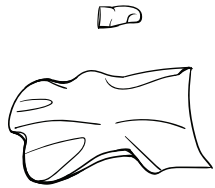

1

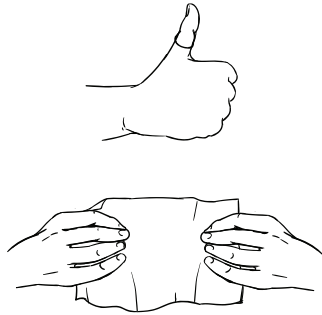

2

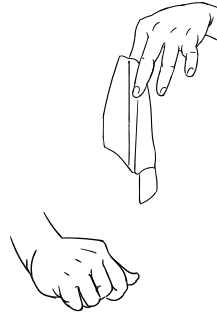

3

4



5

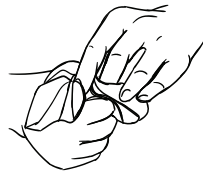

6

7



8

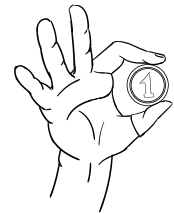

# Trick 37: Spiked Coin

## OBJECTIVE:

Make sharp spikes pierce through a coin, and the coin will stay in perfect shape.

## SETUP:

Find the round box with holes, the spikes, and the coin supplied in your kit.

## INSTRUCTIONS:

1. Show your audience how you are placing the coin inside the round box. Then cover the box.
2. Push a spike into one of the holes that are on the outside corner first. By doing that, you are pushing up the coin and making the coin flip up. So when you push in the rest of the spikes the coin is now on its side (not flat down inside the box).
3. Push the rest of the spikes into the other holes in the box. Pretend you are pushing hard to get the spikes to go through the coin. Since the coin is standing up on its side, it is now out of the way of the spikes.
4. Your audience now thinks that the coin is full of holes. Pull out all the spikes.
5. Uncover the box and show your audience that your coin is whole and intact, without any holes.



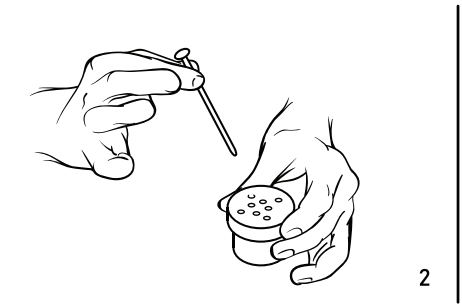
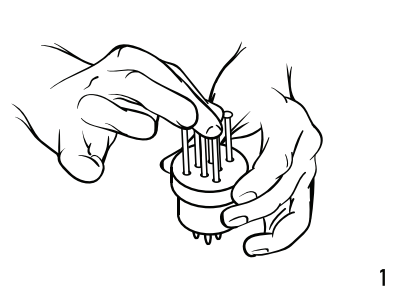
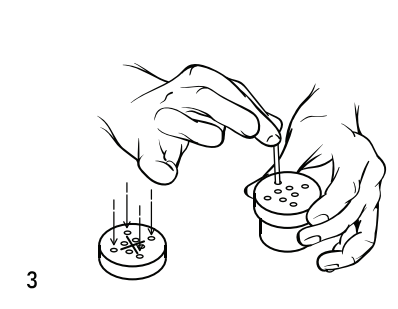
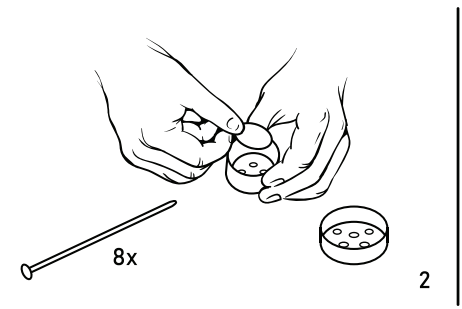
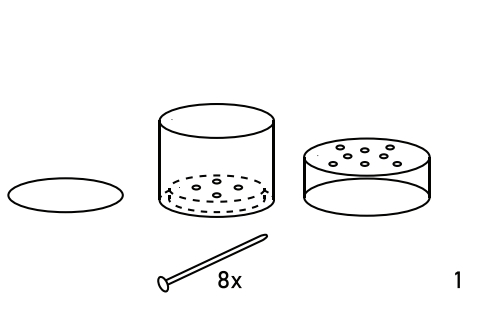

# Trick 38: Traffic Light Trick

## OBJECTIVE:

Your audience will watch up close as you magically change the color and the position of the lights in this mini traffic light.

## SETUP:

You will need just the mini traffic light found in your kit. This trick uses a very simple technique, but the fun part is how you engage your audience with a fascinating story and interesting hand movements.

## INSTRUCTIONS:

1. Hold the traffic light on the side that has all the green lights on it.
2. Push the stick of the traffic light in. This will change the color from green to red. Swoosh it, wave it, flip it or pass it from one hand to the other, so that it isn't obvious that you are pushing the stick in or out.
3. Push it again to change it from red to green.
4. Turn over the traffic light to the other side. This side has green, red, and yellow lights.
5. Change the position of the lights by pushing the stick in. The lights will now be red, yellow and green.
6. When you push it back out, it will change back to green, red, and yellow.

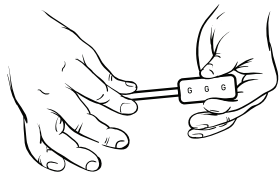

1

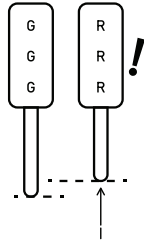

2

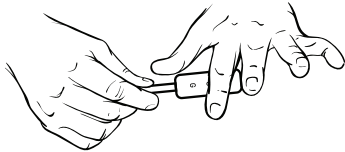
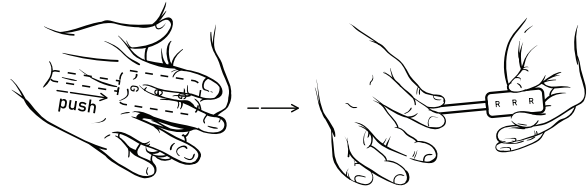

3

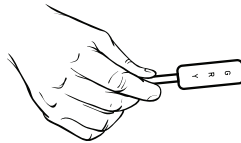

4

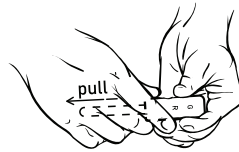

5



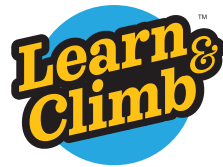

[www.learnandclimb.com](http://www.learnandclimb.com)



Learn & Climb



Learn & Climb



@LearnandClimb

Learn & Climb LLC  
© 2019 all rights reserved