

ITEM NO.	PART NUMBER	DESCRIPTION	QTY.
1	14001	MIXING CHAMBER; PC 1200D, HWS	1
2	14002	MAIN BODY; PC 1200D, HWS	1
3	14003	ABRASIVE INLET ASSY; 3/8", PC 1200D, HWS	1
4	14004	COLLET; NOZZLE NUT, PC 50R/400T/1200D, HWS	1
5	14006	NOZZLE NUT; 3", PC 50R/400T/1200D, HWS	1
6	14008	PROTECTIVE NUT; PC 50R/400T/1200D, HWS	1
7	14009	RUBBER GUARD; PC 50R/400T/1200D, HWS	1
8	99001-206	O-RING; BUNA-N, 70A, -206	1
9	99033	FST; SSS, CP, #10-32 X .438, SS	1

REVISIONS				
NUMBER	REV.	DESCRIPTION	DATE	APPROVED
	A	RELEASED	6/27/2018	JPH
	B	99001-206 WAS 99001-210	3/12/2019	PTF

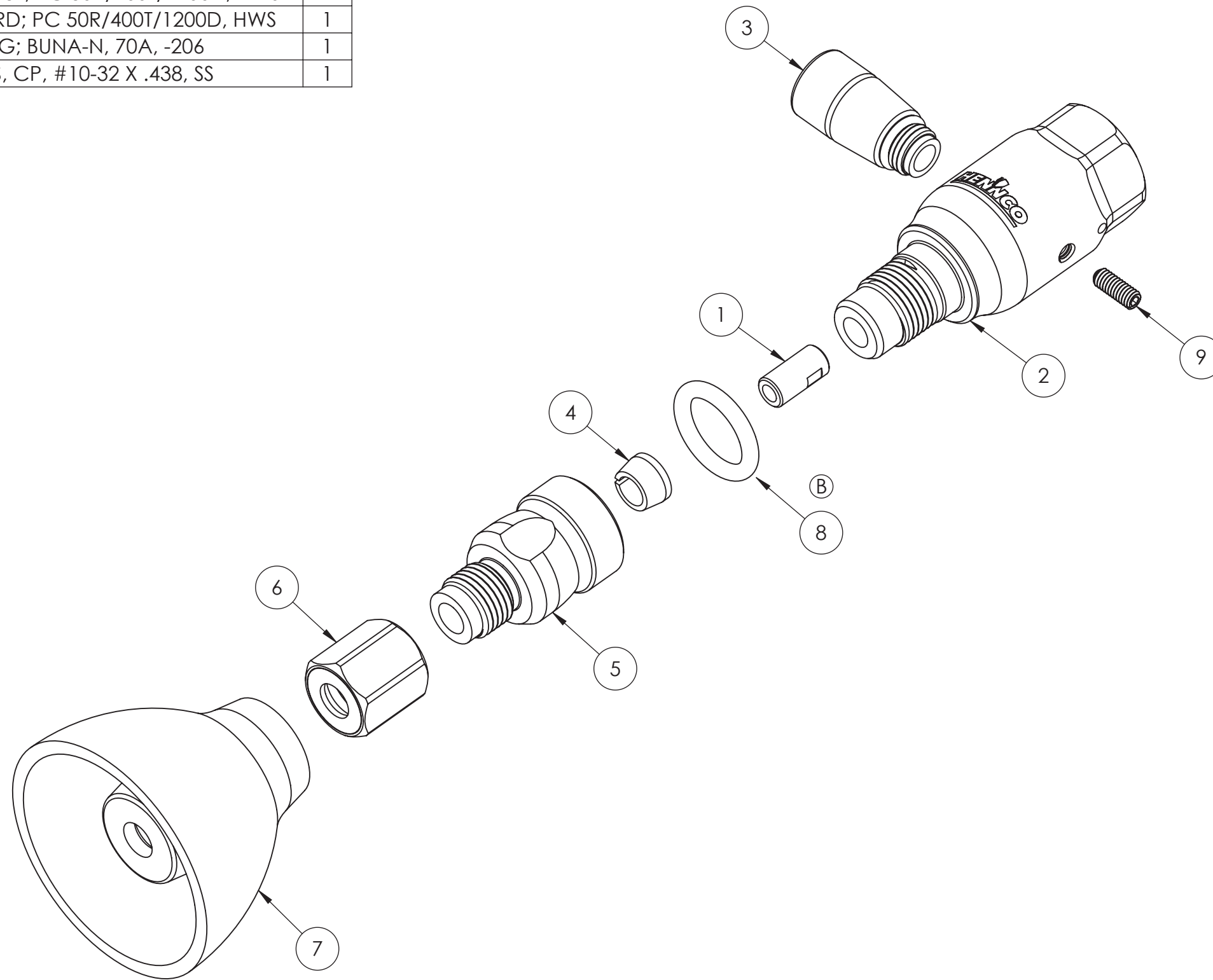

PO BOX 26
 MINNEAPOLIS, MN 55304
 INFO@HENNCOWATERJET.COM
 WWW.HENNCOWATERJET.COM

	NAME	DATE
DRAWN	FOH	6/27/2018
SHEET 1/1	SCALE 1:1	SIZE B

DESCRIPTION	
CUTTING HEAD ASSY; PC 1200D, 3" NUT, HWS	
PART ID 14025	REV B