

USER MANUAL

MODEL:

VM-4H2
4K HDMI 2.0 1:4 DA



Contents

Introduction	1
Getting Started	1
Overview	3
Typical Applications	3
Defining the VM-4H2 4K HDMI 2.0 1:4 DA	4
Setting the DIP-Switches	4
LED Indications	5
Mounting VM-4H2	6
Connecting the VM-4H2	7
EDID Acquisition Policy	8
Upgrading the Firmware	9
Supported Input Resolutions	10
Default EDID	11
Technical Specifications	13

Introduction

Welcome to Kramer Electronics! Since 1981, Kramer Electronics has been providing a world of unique, creative, and affordable solutions to the vast range of problems that confront video, audio, presentation, and broadcasting professionals on a daily basis. In recent years, we have redesigned and upgraded most of our line, making the best even better!

Getting Started

We recommend that you:

- Unpack the equipment carefully and save the original box and packaging materials for possible future shipment.
- Review the contents of this user manual.



Go to www.kramerav.com/downloads/VM-4H2 to check for up-to-date user manuals, application programs, and to check if firmware upgrades are available (where appropriate).

Achieving Best Performance

- Use only good quality connection cables (we recommend Kramer high-performance, high-resolution cables) to avoid interference, deterioration in signal quality due to poor matching, and elevated noise levels (often associated with low quality cables).
- Do not secure the cables in tight bundles or roll the slack into tight coils.
- Avoid interference from neighboring electrical appliances that may adversely influence signal quality.
- Position your Kramer **VM-4H2** away from moisture, excessive sunlight and dust.

Safety Instructions



Caution:

- This equipment is to be used only inside a building. It may only be connected to other equipment that is installed inside a building.
- For products with relay terminals and GPIO ports, please refer to the permitted rating for an external connection, located next to the terminal or in the User Manual.
- There are no operator serviceable parts inside the unit.



Warning:

- Use only the power cord that is supplied with the unit.
- Disconnect the power and unplug the unit from the wall before installing.
- Do not open the unit. High voltages can cause electrical shock! Servicing by qualified personnel only.
- To ensure continuous risk protection, replace fuses only according to the rating specified on the product label which located on the bottom of the unit.

Recycling Kramer Products

The Waste Electrical and Electronic Equipment (WEEE) Directive 2002/96/EC aims to reduce the amount of WEEE sent for disposal to landfill or incineration by requiring it to be collected and recycled. To comply with the WEEE Directive, Kramer Electronics has made arrangements with the European Advanced Recycling Network (EARN) and will cover any costs of treatment, recycling and recovery of waste Kramer Electronics branded equipment on arrival at the EARN facility. For details of Kramer's recycling arrangements in your particular country go to our recycling pages at www.kramerav.com/support/recycling.

Overview

Congratulations on purchasing your Kramer **VM-4H2 4K HDMI 2.0 1:4 DA**. The **VM-4H2** is a distribution amplifier for 4K UHD HDMI™ 2.0 signals. The unit takes one HDMI input, equalizes and reclocks the signal and distributes it to four identical outputs. It distributes signals having resolutions up to 4K@60 (4:4:4) with HDMI 2.0 and HDCP 2.2.

The **VM-4H2** features:

- A maximum data rate of 17.82Gbps (5.94Gbps per graphic channel) that supports resolutions up to 4K @60Hz (4.4.4).
- HDMI support for Deep Color, x.v.Color™, Lip Sync, HDMI Uncompressed Audio Channels, Dolby TrueHD, DTS-HD, CEC.
- HDCP 2.2, HDMI 2.0 support.
- Kramer Equalization & re-Klocking™ Technology that rebuilds the digital signal integrity to travel longer distances.
- A default EDID for fast and efficient connection of the unit.

The default EDID feature lets you connect the **VM-4H2** without having to connect a display to the output.

- Operating modes selectable by DIP-switch: force RGB, lock EDID, HDCP enable, programming mode.
- 3D pass-through.
- Plug and Play operation.
- Cascade of Kramer devices like distribution amplifiers.
- An RS-232 port for upgrading firmware.
- A compact MegaTOOLS® enclosure with a 5V DC power source.

Typical Applications

VM-4H2 is ideal for the following typical applications:

- Digital signage, entertainment, retail.
- Medical and defense applications that require high resolution support.

Defining the VM-4H2 4K HDMI 2.0 1:4 DA

This section defines the VM-4H2.

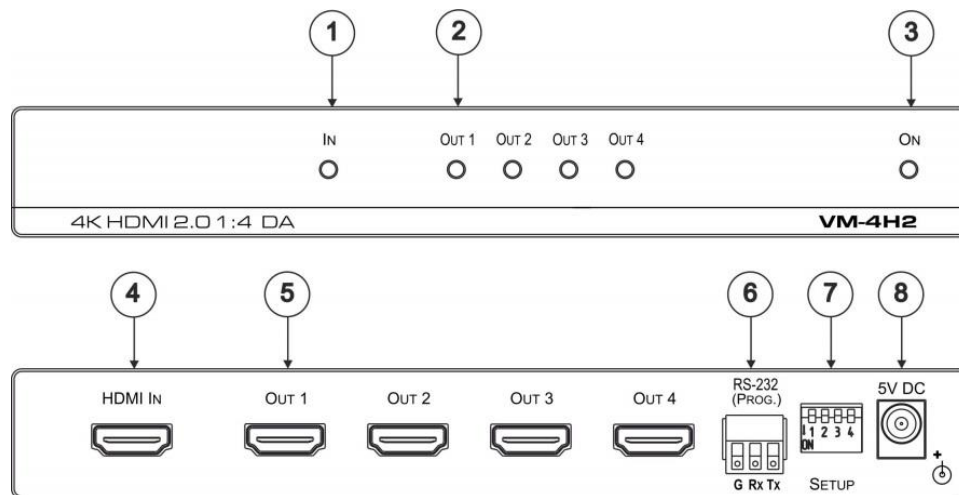

Figure 1: VM-4H2 4K HDMI 2.0 1:4 DA

#	Feature	Function
1	IN LED	Lights green when an HDMI source is connected
2	OUT LEDs (1-4)	Light green when an HDMI acceptor is connected
3	ON LED	Lights green when the unit is powered on
4	HDMI IN Connector	Connects to an HDMI source
5	HDMI OUT Connectors (1 to 4)	Connect to up to four HDMI acceptors
6	RS-232 (PROG) Terminal Block	Connects to a PC for firmware updating
7	SETUP DIP-Switches (1-4)	Used for setting four different operation modes (see Setting the DIP-Switches on page 4)
8	5V DC Power Connector	Connects to a 5V DC power supply

Setting the DIP-Switches

The VM-4H2 uses four DIP-switches to set four different operation modes:

- **Programming mode** – normal operation mode, programming mode.
- **MAC mode** – enable HDCP, disable input HDCP.
- **Force RGB** - force RGB, normal operation mode.
- **Lock default EDID** – locked, not locked.



Any time the DIP-switch settings are changed, the device must be powered off and on for the new settings to take effect.

To select the operation mode, set the DIP-switches as follows:

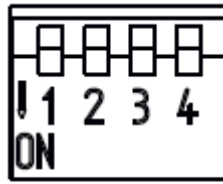

SETUP

	Programming mode	HDCP Input (MAC mode)	Force RGB	Lock Default EDID
DIP	1	2	3	4
OFF (up)	Normal mode	HDCP enabled	Force RGB	EDID not locked
ON (down)	Enable programming	HDCP disabled	Normal mode	EDID locked

The **VM-4H2** toggles between “Normal” and “Force RGB” modes.



In “Force RGB” mode, the read EDID is rewritten to identify only RGB support.

- To force RGB, set DIP 3 OFF (up)
- After setting Force RGB mode you must re-acquire the EDID to update the Force RGB change

Powering on the device identifies the mode as follows:

- In “Normal mode” (meaning no forcing RGB), the LEDs flash once.
- In “Force RGB mode”, the LEDs flash four times.



Force RGB modifies the EDID saved on the input to not support YUV format. In case of a pink display, use the Force RGB mode.

LED Indications

The input and output LEDs turn on only when there is an input signal and an active output device connected.

Flashing LEDs indicate the following states:

LED	Indication	State
Input LED (per input)	Flashes four times then stays on	HDCP lost on input while running
Output LED	Flashes twice quickly, repeatedly	HDCP signal on input. Output device does not support HDCP
	Flashes slowly, repeatedly	Input signal detected. Output device has invalid EDID
	Flashes twice quickly then twice slowly, repeatedly	HDCP signal on input. Output device does not support HDCP and has invalid EDID

Mounting VM-4H2

This section provides instructions for mounting **VM-4H2**. Before installing, verify that the environment is within the recommended range:



- Operation temperature – 0° to 40°C (32 to 104°F).
- Storage temperature – -40° to +70°C (-40 to +158°F).
- Humidity – 10% to 90%, RHL non-condensing.

**Caution:**

- Mount **VM-4H2** before connecting any cables or power.

**Warning:**

- Ensure that the environment (e.g., maximum ambient temperature & air flow) is compatible for the device.
- Avoid uneven mechanical loading.
- Appropriate consideration of equipment nameplate ratings should be used for avoiding overloading of the circuits.
- Reliable earthing of rack-mounted equipment should be maintained.

To mount the VM-4H2 on a rack

Mount the unit in a rack using the recommended rack adapter (see www.kramerav.com/product/VM-4H2)

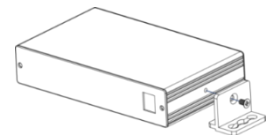

To mount the VM-4H2 on a table or shelf

- Attach the rubber feet and place the unit on a flat surface.
- Fasten a bracket (included) on each side of the unit and attach it to a flat surface.



For more information go to www.kramerav.com/downloads/VM-4H2

Connecting the VM-4H2

-  Always switch off the power to each device before connecting it to your **VM-4H2**. After connecting your **VM-4H2**, connect its power and then switch on the power to each device.
-  You do not have to connect all the inputs and outputs, connect only those that are required.

To connect the **VM-4H2**, as illustrated in the example in [Figure 2](#), do the following:

1. Connect an HDMI input source (for example, a 4K Blu-ray player) to the HDMI IN connector.
2. Connect the four OUTPUT connectors to up to four HDMI acceptors, as follows:

-  Not all outputs need to be connected.

- HDMI OUT 1 connector to HDMI acceptor 1 (for example, a 4K display with speakers).
 - HDMI OUT 2 connector to HDMI acceptor 2 (for example, a 4K display with speakers).
 - HDMI OUT 3 connector to HDMI acceptor 3 (for example, 4K plasma display).
 - HDMI OUT 4 connector to HDMI acceptor 4 (for example, 4K plasma display).
3. Connect the 5V DC power adapter to the power socket unit and then connect the adapter to the mains electricity (**not shown in [Figure 2](#)**).

See [LED Indications](#) on page [5](#) for the state of the LED indicators during and after powering on.

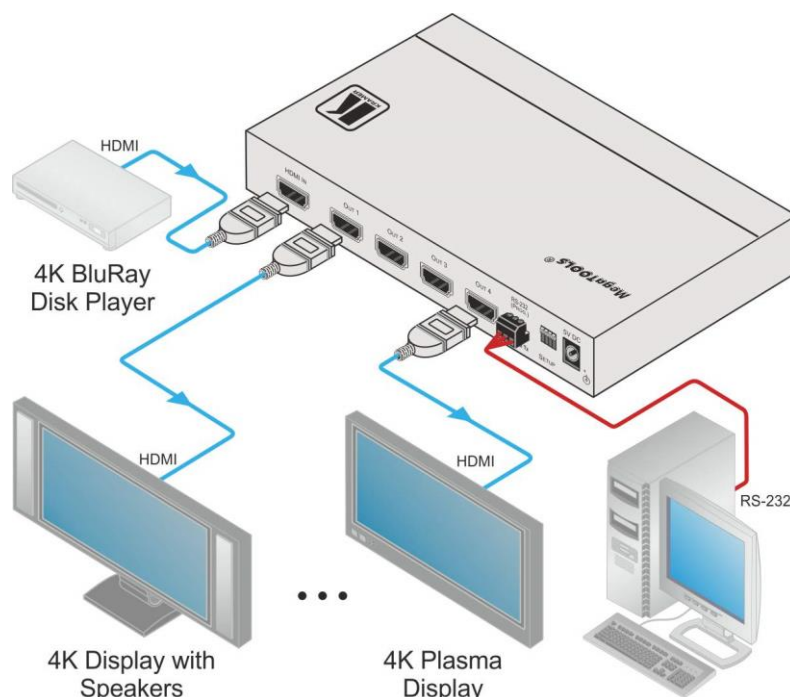

Figure 2: Connecting the VM-4H2 4K HDMI 2.0 1:4 DA

EDID Acquisition Policy

This section describes the EDID policy as a function of the state of DIP-switch 4 (Lock Default EDID).

When set to ON (down), the input EDID is locked to the default EDID value.

When set to OFF (up):

- If no outputs are connected when powering on the **VM-4H2**, the default EDID is set on the input. The EDID of the first output that is connected after powering the device is set to the input. This EDID is replaced by the default EDID only when all outputs are disconnected.
- If one or more outputs are already connected when powering on the **VM-4H2**, the valid EDID of the display that is connected to the output with the highest number is set to the input (for example, if OUT 2 and OUT 4 are connected and both have valid EDIDs, when powering the device, the EDID of the display connected to OUT 4 is written to the input).



DIP-switch changes take effect only after powering on the device.

Upgrading the Firmware

To upgrade the **VM-4H2** firmware:

1. Turn off the **VM-4H2**. Set DIP-switch 1 On (down). Turn on the **VM-4H2**.
2. Download and install the EPConsole application from the Koryo (Taiwan) Web site.
3. Download and extract the latest version of the firmware from the Kramer Web site to a disk location on your PC. The firmware includes three files with names ending in .h00, .h01, .h02. Make sure they all exist in the same folder.
4. Run EPConsole.
5. Select the COM port that attaches to the **VM-4H2**.
6. Specify the downloaded firmware file ending with .h00 as the BANK0 file. The program automatically loads the other two files in banks 1 and 2.
7. Press Program MCU icon (downward pointing green arrow) to install the new firmware:

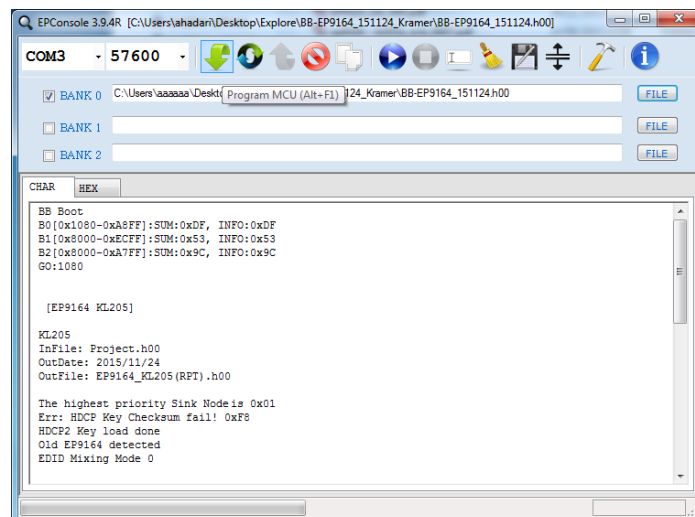

8. After the firmware successfully downloads:



In case of failure, rerun the previous process:

- Power off the unit.
- Disconnect the RS-232 cable.
- Set DIP-switch 1 Off (up).
- Power on the **VM-4H2** to load the new firmware and resume operation.

Supported Input Resolutions

640x480p 60Hz
 640x480p 72Hz
 640x480p 75Hz
 640x480p 85Hz
 720x480i 30Hz
 720x480p 60Hz
 720x576p 50Hz
 800x600p 60Hz
 800x600p 72Hz
 800x600p 75Hz
 800x600p 85Hz
 848x480p 60Hz
 852x480p 60Hz
 1024x768p 60Hz
 1024x768p 70Hz
 1024x768p 75Hz
 1024x768p 85Hz
 1152x864p 75Hz
 1280x768p 60Hz
 1280x800p 60Hz
 1280x960 60Hz
 1280x1024p 60Hz
 1280x1024p 75Hz
 1360x768p 60Hz
 1366x768p 50Hz
 1366x768 60Hz
 1400x1050p 60Hz
 1440x900p 60Hz
 1600x900p 60Hz
 1600x1200p 60Hz
 1680x1050p 60Hz
 1920x1080i 50Hz
 1920x1080i 60Hz
 1920x1080p 24Hz
 1920x1080p 30Hz
 1920x1080p 50Hz
 1920x1080p 60Hz
 3840x2160p 24Hz 16:9
 3840x2160p 30Hz 16:9
 3840x2160p 60Hz 16:9
 4096x2160p 24Hz 256:135
 4096x2160p 30Hz 256:135
 4096x2160p 60Hz 256:135 (Default)
 3840x2160p 24Hz 64:27
 3840x2160p 30Hz 64:27
 3840x2160p 60Hz 64:27

Default EDID

Monitor

Model name..... VM-4H2
 Manufacturer..... KMR
 Plug and Play ID..... KMR1200
 Serial number..... n/a
 Manufacture date..... 2016, ISO week 14
 Filter driver..... None

 EDID revision..... 1.3
 Input signal type..... Digital
 Color bit depth..... Undefined
 Display type..... RGB color
 Screen size..... 520 x 320 mm (24.0 in)
 Power management..... Standby, Suspend, Active off/sleep
 Extension blocs..... 1 (CEA-EXT)

 DDC/CI..... n/a
 Color characteristics
 Default color space..... Non-sRGB
 Display gamma..... 2.20
 Red chromaticity..... Rx 0.674 - Ry 0.319
 Green chromaticity..... Gx 0.188 - Gy 0.706
 Blue chromaticity..... Bx 0.148 - By 0.064
 White point (default).... Wx 0.313 - Wy 0.329
 Additional descriptors... None
 Timing characteristics
 Horizontal scan range.... 30-83kHz
 Vertical scan range..... 56-76Hz
 Video bandwidth..... 170MHz
 CVT standard..... Not supported
 GTF standard..... Not supported
 Additional descriptors... Established timings
 Preferred timing..... Yes
 Native/preferred timing.. 1920x1080p at 60Hz
 Modeline..... "1920x1080" 148.500 1920 2008 2052 2200 1084 1084 1089 1125 +hsync +vsync
 Standard timings supported
 640 x 480p at 60Hz - IBM VGA
 640 x 480p at 72Hz - VESA
 640 x 480p at 75Hz - VESA
 800 x 600p at 60Hz - VESA
 800 x 600p at 72Hz - VESA
 800 x 600p at 75Hz - VESA
 1024 x 768p at 60Hz - VESA
 1024 x 768p at 70Hz - VESA
 1024 x 768p at 75Hz - VESA
 1280 x 1024p at 75Hz - VESA
 1600 x 900p at 60Hz - VESA STD
 1280 x 800p at 60Hz - VESA STD
 1600 x 1200p at 60Hz - VESA STD
 1024 x 768p at 85Hz - VESA STD
 800 x 600p at 85Hz - VESA STD
 640 x 480p at 85Hz - VESA STD
 1152 x 864p at 75Hz - VESA STD
 1280 x 960p at 60Hz - VESA STD
 848 x 480p at 60Hz - VESA
 1280 x 768p at 60Hz - VESA
 1280 x 1024p at 60Hz - VESA
 1360 x 768p at 60Hz - VESA
 1440 x 900p at 60Hz - VESA
 1400 x 1050p at 60Hz - VESA
 1680 x 1050p at 60Hz - VESA
 EIA/CEA-861 Information
 Revision number..... 3
 IT underscan..... Supported
 Basic audio..... Supported
 YCbCr 4:4:4..... Supported
 YCbCr 4:2:2..... Supported
 Native formats..... 0
 Detailed timing #1..... 720x480i at 30Hz
 Modeline..... "720x480" 8.490 720 808 852 1000 480 488 498 570 interlace +hsync +vsync
 Detailed timing #2..... 852x480p at 60Hz (16:9)
 Modeline..... "852x480" 49.450 852 1380 1424 1572 480 484 489 525 +hsync +vsync
 Detailed timing #3..... 1366x768p at 50Hz (16:9)
 Modeline..... "1366x768" 84.650 1366 1894 1938 2086 768 772 777 813 +hsync +vsync
 Detailed timing #4..... 1366x768p at 60Hz (16:9)
 Modeline..... "1366x768" 101.610 1366 1894 1938 2086 768 772 777 813 +hsync +vsync

Detailed timing #5..... 720x576p at 50Hz (4:3)
 Modeline..... "720x576" 27.370 720 728 824 880 576 578 596 621 -hsync -vsync
 CE video identifiers (VICs) - timing/formats supported
 1920 x 1080p at 60Hz - HDTV (16:9, 1:1) [Native]
 1920 x 1080i at 60Hz - HDTV (16:9, 1:1)
 720 x 480p at 60Hz - EDTV (4:3, 8:9)
 1920 x 1080i at 50Hz - HDTV (16:9, 1:1)
 1920 x 1080p at 50Hz - HDTV (16:9, 1:1)
 1920 x 1080p at 24Hz - HDTV (16:9, 1:1)
 1920 x 1080p at 30Hz - HDTV (16:9, 1:1)
 3840 x 2160p at 24Hz - HDTV (16:9, 1:1)
 3840 x 2160p at 30Hz - HDTV (16:9, 1:1)
 3840 x 2160p at 60Hz - HDTV (16:9, 1:1)
 4096 x 2160p at 24Hz - HDTV (256:135, 1:1)
 4096 x 2160p at 30Hz - HDTV (256:135, 1:1)
 4096 x 2160p at 60Hz - HDTV (256:135, 1:1)
 3840 x 2160p at 24Hz - HDTV (4:3, 1:1)
 3840 x 2160p at 30Hz - HDTV (4:3, 1:1)
 3840 x 2160p at 60Hz - HDTV (4:3, 1:1)
 NB: NTSC refresh rate = (Hz*1000)/1001
 CE audio data (formats supported)
 LPCM 2-channel, 16/20/24 bit depths at 32/44/48 kHz
 CE speaker allocation data
 Channel configuration.... 2.0
 Front left/right..... Yes
 Front LFE..... No
 Front center..... No
 Rear left/right..... No
 Rear center..... No
 Front left/right center.. No
 Rear left/right center... No
 Rear LFE..... No
 CE vendor specific data (VSDB)
 IEEE registration number. 0x000C03
 CEC physical address..... 1.0.0.0
 Maximum TMDS clock..... 165MHz
 Report information
 Date generated..... 4/17/2016
 Software revision..... 2.90.0.1002
 Data source..... File
 Operating system..... 6.1.7601.2.Service Pack 1
 Raw data
 00,FF,FF,FF,FF,FF,FF,00,2D,B2,00,12,00,00,00,00,0E,1A,01,03,80,34,20,78,EA,B3,25,AC,51,30,B4,26,
 10,50,54,2D,CF,00,A9,C0,81,00,A9,40,61,59,45,59,31,59,71,4F,81,40,02,3A,80,18,71,38,2D,40,58,2C,
 45,00,0F,24,21,00,00,1E,00,00,00,FD,00,38,4C,1E,53,11,00,0A,20,20,20,20,20,20,00,00,00,FC,00,56,
 4D,2D,34,48,32,0A,20,20,20,20,20,20,00,00,00,F7,00,00,08,42,A2,20,00,00,00,00,00,00,01,B4,
 02,03,23,F0,50,90,05,02,14,1F,20,22,5D,5F,61,62,64,66,67,69,6B,23,09,07,07,83,01,00,00,65,03,0C,
 00,10,00,51,03,D0,18,21,F0,2D,00,58,2C,45,00,0F,1A,21,00,00,9E,51,13,54,D0,32,E0,2D,10,10,2C,45,
 80,BA,88,21,00,00,1E,11,21,56,D0,52,00,2D,30,10,2C,45,80,BA,88,21,00,00,1E,B1,27,56,D0,52,00,2D,
 30,10,2C,45,80,BA,88,21,00,00,1E,B1,0A,D0,A0,20,40,2D,20,08,60,22,01,80,E0,21,00,00,00,00,F1,B5

Technical Specifications

INPUT:	1 HDMI connector
OUTPUTS:	4 HDMI connectors
PORT:	1 RS-232 for firmware upgrade
MAX. DATA RATE:	17.82Gbps (5.94Gbps per graphic channel) supporting resolutions up to 4K @60Hz (4.4.4)
RS-232 BAUD RATE:	57600
COMPLIANCE WITH HDMI STANDARD:	Supports HDMI 2.0 and HDCP 2.2
INDICATOR LEDs:	ON, IN, OUT 1 to 4
OPERATING TEMPERATURE:	0° to +40°C (32° to 104°F)
STORAGE TEMPERATURE:	-40° to +70°C (-40° to 158°F)
HUMIDITY:	10% to 90%, RHL non-condensing
POWER CONSUMPTION:	5V DC, 730mA
DIMENSIONS:	18.75cm x 11.5cm x 2.54cm (7.4" x 4.5" x 1.0") W, D, H, ½ 19" 1U
WEIGHT:	0.17kg (0.37lb)
SHIPPING DIMENSIONS:	35.1cm x 21.2cm x 7.2cm (13.8" x 8.4" x 2.8") W, D, H
SHIPPING WEIGHT:	0.67kg (0.67lb)
INCLUDED ACCESSORIES:	Power supply
Specifications are subject to change without notice For the most updated resolution list, go to our Web site at http://www.kramerav.com	

The warranty obligations of Kramer Electronics Inc. ("Kramer Electronics") for this product are limited to the terms set forth below:

What is Covered

This limited warranty covers defects in materials and workmanship in this product.

What is Not Covered

This limited warranty does not cover any damage, deterioration or malfunction resulting from any alteration, modification, improper or unreasonable use or maintenance, misuse, abuse, accident, neglect, exposure to excess moisture, fire, improper packing and shipping (such claims must be presented to the carrier), lightning, power surges, or other acts of nature. This limited warranty does not cover any damage, deterioration or malfunction resulting from the installation or removal of this product from any installation, any unauthorized tampering with this product, any repairs attempted by anyone unauthorized by Kramer Electronics to make such repairs, or any other cause which does not relate directly to a defect in materials and/or workmanship of this product. This limited warranty does not cover cartons, equipment enclosures, cables or accessories used in conjunction with this product. Without limiting any other exclusion herein, Kramer Electronics does not warrant that the product covered hereby, including, without limitation, the technology and/or integrated circuit(s) included in the product, will not become obsolete or that such items are or will remain compatible with any other product or technology with which the product may be used.

How Long this Coverage Lasts

The standard limited warranty for Kramer products is seven (7) years from the date of original purchase, with the following exceptions:

1. All Kramer VIA hardware products are covered by a standard three (3) year warranty for the VIA hardware and a standard three (3) year warranty for firmware and software updates; all Kramer VIA accessories, adapters, tags, and dongles are covered by a standard one (1) year warranty.
2. All Kramer fiber optic cables, adapter-size fiber optic extenders, pluggable optical modules, active cables, cable retractors, all ring mounted adapters, all Kramer speakers and Kramer touch panels are covered by a standard one (1) year warranty.
3. All Kramer Cobra products, all Kramer Calibre products, all Kramer Minicom digital signage products, all HighSecLabs products, all streaming, and all wireless products are covered by a standard three (3) year warranty.
4. All Sierra Video MultiViewers are covered by a standard five (5) year warranty.
5. Sierra switchers & control panels are covered by a standard seven (7) year warranty (excluding power supplies and fans that are covered for three (3) years).
6. K-Touch software is covered by a standard one (1) year warranty for software updates.
7. All Kramer passive cables are covered by a ten (10) year warranty.

Who is Covered

Only the original purchaser of this product is covered under this limited warranty. This limited warranty is not transferable to subsequent purchasers or owners of this product.

What Kramer Electronics Will Do

Kramer Electronics will, at its sole option, provide one of the following three remedies to whatever extent it shall deem necessary to satisfy a proper claim under this limited warranty:

1. Elect to repair or facilitate the repair of any defective parts within a reasonable period of time, free of any charge for the necessary parts and labor to complete the repair and restore this product to its proper operating condition. Kramer Electronics will also pay the shipping costs necessary to return this product once the repair is complete.
2. Replace this product with a direct replacement or with a similar product deemed by Kramer Electronics to perform substantially the same function as the original product.
3. Issue a refund of the original purchase price less depreciation to be determined based on the age of the product at the time remedy is sought under this limited warranty.

What Kramer Electronics Will Not Do Under This Limited Warranty

If this product is returned to Kramer Electronics or the authorized dealer from which it was purchased or any other party authorized to repair Kramer Electronics products, this product must be insured during shipment, with the insurance and shipping charges prepaid by you. If this product is returned uninsured, you assume all risks of loss or damage during shipment. Kramer Electronics will not be responsible for any costs related to the removal or re-installation of this product from or into any installation. Kramer Electronics will not be responsible for any costs related to any setting up this product, any adjustment of user controls or any programming required for a specific installation of this product.

How to Obtain a Remedy Under This Limited Warranty

To obtain a remedy under this limited warranty, you must contact either the authorized Kramer Electronics reseller from whom you purchased this product or the Kramer Electronics office nearest you. For a list of authorized Kramer Electronics resellers and/or Kramer Electronics authorized service providers, visit our web site at www.kramerav.com or contact the Kramer Electronics office nearest you.

In order to pursue any remedy under this limited warranty, you must possess an original, dated receipt as proof of purchase from an authorized Kramer Electronics reseller. If this product is returned under this limited warranty, a return authorization number, obtained from Kramer Electronics, will be required (RMA number). You may also be directed to an authorized reseller or a person authorized by Kramer Electronics to repair the product.

If it is decided that this product should be returned directly to Kramer Electronics, this product should be properly packed, preferably in the original carton, for shipping. Cartons not bearing a return authorization number will be refused.

Limitation of Liability

THE MAXIMUM LIABILITY OF KRAMER ELECTRONICS UNDER THIS LIMITED WARRANTY SHALL NOT EXCEED THE ACTUAL PURCHASE PRICE PAID FOR THE PRODUCT. TO THE MAXIMUM EXTENT PERMITTED BY LAW, KRAMER ELECTRONICS IS NOT RESPONSIBLE FOR DIRECT, SPECIAL, INCIDENTAL OR CONSEQUENTIAL DAMAGES RESULTING FROM ANY BREACH OF WARRANTY OR CONDITION, OR UNDER ANY OTHER LEGAL THEORY. Some countries, districts or states do not allow the exclusion or limitation of relief, special, incidental, consequential or indirect damages, or the limitation of liability to specified amounts, so the above limitations or exclusions may not apply to you.

Exclusive Remedy

TO THE MAXIMUM EXTENT PERMITTED BY LAW, THIS LIMITED WARRANTY AND THE REMEDIES SET FORTH ABOVE ARE EXCLUSIVE AND IN LIEU OF ALL OTHER WARRANTIES, REMEDIES AND CONDITIONS, WHETHER ORAL OR WRITTEN, EXPRESS OR IMPLIED. TO THE MAXIMUM EXTENT PERMITTED BY LAW, KRAMER ELECTRONICS SPECIFICALLY DISCLAIMS ANY AND ALL IMPLIED WARRANTIES, INCLUDING, WITHOUT LIMITATION, WARRANTIES OF MERCHANTABILITY AND FITNESS FOR A PARTICULAR PURPOSE. IF KRAMER ELECTRONICS CANNOT LAWFULLY DISCLAIM OR EXCLUDE IMPLIED WARRANTIES UNDER APPLICABLE LAW, THEN ALL IMPLIED WARRANTIES COVERING THIS PRODUCT, INCLUDING WARRANTIES OF MERCHANTABILITY AND FITNESS FOR A PARTICULAR PURPOSE, SHALL APPLY TO THIS PRODUCT AS PROVIDED UNDER APPLICABLE LAW. IF ANY PRODUCT TO WHICH THIS LIMITED WARRANTY APPLIES IS A "CONSUMER PRODUCT" UNDER THE MAGNUSON-MOSS WARRANTY ACT (15 U.S.C.A. §2301, ET SEQ.) OR OTHER APPLICABLE LAW, THE FOREGOING DISCLAIMER OF IMPLIED WARRANTIES SHALL NOT APPLY TO YOU, AND ALL IMPLIED WARRANTIES ON THIS PRODUCT, INCLUDING WARRANTIES OF MERCHANTABILITY AND FITNESS FOR THE PARTICULAR PURPOSE, SHALL APPLY AS PROVIDED UNDER APPLICABLE LAW.

Other Conditions

This limited warranty gives you specific legal rights, and you may have other rights which vary from country to country or state to state.

This limited warranty is void if (i) the label bearing the serial number of this product has been removed or defaced, (ii) the product is not distributed by Kramer Electronics or (iii) this product is not purchased from an authorized Kramer Electronics reseller. If you are unsure whether a reseller is an authorized Kramer Electronics reseller, visit our web site at www.kramerav.com or contact a Kramer Electronics office from the list at the end of this document.

Your rights under this limited warranty are not diminished if you do not complete and return the product registration form or complete and submit the online product registration form. Kramer Electronics thanks you for purchasing a Kramer Electronics product. We hope it will give you years of satisfaction.



SAFETY WARNING

Disconnect the unit from the power supply before opening and servicing

For the latest information on our products and a list of Kramer distributors, visit our website where updates to this user manual may be found.

We welcome your questions, comments, and feedback.

The terms HDMI, HDMI High-Definition Multimedia Interface, and the HDMI Logo are trademarks or registered trademarks of HDMI Licensing Administrator, Inc. All brand names, product names, and trademarks are the property of their respective owners.