



VOGUE UK

TOWEL WARMERS & RADIATORS



VOGUE UK
TOWEL WARMERS & RADIATORS

EST | 1990

Welcome to Vogue UK - the country's leading manufacturer of heated towel warmers, designer radiators and accessories. Established in 1990 within the heart of the West Midlands. Vogue UK continues to design and create more products than any other company in this field, constantly leading the trend by combining fashion with functionality.

Everyone has their own sense of style and that's why Vogue UK has created a range of quintessential products that meet the needs of every interior design style. If you require something unique then our craftsmen can create a design to your exact brief. As Vogue UK have been creating towel warmers and designer radiators since 1990 the company has built an extensive portfolio of designs and can offer a bespoke service, ideal if you're looking to create an authentic period look or simply match an existing design.

Our seven categories of products in this brochure and on our website are sure to encompass the perfect design for you...no matter what shape, style or size you're looking for.



From contemporary to traditional

We've been at the forefront of towel rail and radiator design for 30 years. It's easy to see why.

We work with some of the UK's leading interior designers who create a range that's unlike anything else. Full of inspiration and innovative design in stunning colours and finishes, we turn heating your room into a style statement.

Plus, we know every home is unique in so many ways and we've created a range that reflects the style and personality of our homes today. From timeless classics, expertly engineered for modern life, to cutting edge contemporary design that gives you a glimpse of the future - whatever your style, you'll find the perfect one for you.

Contemporary	10 - 65
Ladder Rails	66 - 83
Traditional	84 - 113
Designer Radiators	118 - 141
Electric	142 - 145
Additions	150 - 161
Bespoke Service	162 - 164

*Fashion and
functionality,
beautifully crafted*

| Designed around you

We know one size, one colour or even one style doesn't fit all. It's why we offer three levels of our bespoke design and manufacture service.

Customise our collection

If you like what you see, but it doesn't fit your exact requirements, no problem. You can customise your towel rail or radiator dimensions, materials and finishes.

See your design come to life

We can work from any design specification and handcraft special products from high-quality brass, stainless steel or mild steel. We will offer expert advice to ensure your design not only looks amazing, but performs too.

Fully commissioned project work with our team of designers and engineers in this collaborative design process to create exactly what you are looking for. We'll bring your vision to life and manufacture your bespoke towel rail or radiator.

Designs are created with care, precision and passion



Bespoke Colours

From bright bold gloss colours to soft, relaxing muted tones. Shimmering metallic finishes to hardwearing crackle paints, we have the right colour for your home.

Page 162

Joints

When creating a stylish towel rail or radiator the joint details can make all the difference. We have 15 different designs to choose from, all expertly handcrafted by us.

Page 164

Valves & Accessories

From simple and stylish to ornate, time-honoured designs, we have a range of valves & accessories that add the perfect finishing touch to your creation

Pages 156 - 161

Tubing

Simple, smooth and round to hexagonal and embellished options. We have lots of styles to choose from. So, pick your tubing and put your individual stamp on your design.

Page 164



VOGUE UK

TOWEL WARMERS & RADIATORS

The evolution of the heated towel warmer stretches way back into the 1800's. In 1834 a man named Denison Olmstead of New Haven, Connecticut created a heat exchanger for his stove which he described as a 'peculiar kind of apparatus, which I call a radiator'. However, it wasn't until 1855, Franz San Galli of St. Petersburg invented the heating radiator.

So the journey began... the radiator became more popular and spread to every room in the home. Once heating reached the bathroom it became unrealistic for towels to dry and pile-up on the radiator and so, the inevitable arrival of the towel warmer came to pass.

The 1920's saw the first of the cast iron water heated towel warmers, commonly referred to as a 'bath radiator'. Here in the UK, drying racks, heated towel warmers and heated towel bars were seen as luxury items and would only ever be found in homes and hotels of high upstanding social status.

As time passed, new materials became available and our abilities to manipulate and manufacture these materials grew. Materials such as copper, brass, mild steel and stainless steel helped to propel the industry forward.

Arriving in the present day and now we have yet more advancement brought to you by Vogue UK, who for 30 years has been manufacturing and innovating many styles and designs into the towel warmer arena.

Brass Manufacture

BR DZR Brass
The highest quality brass available in a finish of your choice. Corrosion resistant and provides a superior plated finish.

H Heating and Hot Water
Suitable for all heating and hot water systems.

Stainless Steel Manufacture

SS Stainless Steel
Giving an easy to clean finish that is resistant to corrosion and has a high heat output.

H Heating and Hot Water
Suitable for all heating and hot water systems.

Mild Steel Manufacture

MS Mild Steel
Quality mild steel available in chrome and painted finishes suitable for indirect/closed heating systems.

C Heating Only
Suitable for closed indirect heating systems.

Aluminium Manufacture

AL Aluminium
Providing a quick heat up time thus allowing for greater efficiency with a low water content.

H Heating and Hot Water
Suitable for all heating and hot water systems.

Additional Requirements

E Electric Only
Can be specified where this symbol is displayed. Please see page 152 for full range and price supplements.

DL Electric Dryline
Can be specified where this symbol is displayed. Dryline technology, heating via a heater cable. POA

D Heating and Electric
Can be specified where this symbol is displayed. Please see page 152 for full range and price supplements.

 **RAL Colours**
Available in RAL colour Chart options. Please see page 158 for colour options and price supplement.

Stock Information

 **Stocked Item**
The 'Tick' symbol in the product specification tables denotes a stocked item.

 **Additional Production Process**
The 'Stopwatch' denotes a stocked item that under goes additional production processes to achieve chosen finish.

 **Made-to-order**
The 'Handprint' symbol in the product specification tables denotes a made to order product.

For further information please contact +44 (0) 1902 387000 or email sales@vogueuk.co.uk



Contemporary

Clean lines, stunning finishes, and amazingly practical too. Make a statement with our range of contemporary designs that are leading the way in modern towel rail and radiator innovation.

Aquila DR016
See page 40

Concertina

Wall Mounted DR010

Concertina is a beautiful iconic rail. Towels slide easily in from the side and can be left or right hand mounted. Manufactured from high quality mild steel. Prices shown are for chrome finished for central heating models.



Marine

Wall Mounted DR009

The Marine's innovative design is a focal point for any bathroom. The looped horizontal rails maximise both heat output and hanging space. Manufactured from high quality mild steel. Prices shown are for chrome finished for central heating models.



MS C D E

Concertina

Tube diameter Ø 19 + 32mm	Dimensions (mm)			Bar Config	Pipe Centres	Electric Element wattage	Output ΔT 50°C Watts/BTU's	Output ΔT 60°C BTU's	Price (ex VAT) Chrome	Price (inc VAT) Chrome	Stock or made to order
	H	W	D								
DR010	1000	500	111	12	75	150	226 / 771	975	362.00	434.40	✓
DR010	1000	600	111	12	75	200	311 / 1061	1341	428.00	513.60	✓
DR010	1200	500	111	14	75	200	383 / 1307	1652	457.00	548.40	✓
DR010	1200	600	111	14	75	300	423 / 1443	1824	547.00	656.40	✓

For electric element & valve options see pages 154 & 160



VL003

MS C D E

Marine

Tube diameter Ø 19 + 32mm	Dimensions (mm)			Bar Config	Pipe Centres	Electric element wattage	Output ΔT 50°C Watts/BTU's	Output ΔT 60°C BTU's	Price (ex VAT) Chrome	Price (inc VAT) Chrome	Stock or made to order
	H	W	D								
DR009	1400	600	177	25	110	400	767 / 2617	3308	739.00	886.80	✓

For electric element & valve options see pages 154 & 160



VL003

Cygnus

Wall Mounted DR012

Cygnus is a handsome and highly practical design. The looped horizontal rails maximise both heat output and hanging space. Finished in chrome. Manufactured from high quality mild steel. Prices shown are chrome finish for central heating models.



Mild Steel Metallic Finish Supplements
 Gold - POA
 Bright Nickel - Chrome £221.00 ex VAT, £265.20 inc VAT



For electric element & valve options see pages 154 & 160 VL003

MS C D E

Cygnus

Tube diameter Ø 19 + 32mm	Dimensions (mm)			Bar Config	Pipe Centres	Electric element wattage	Output ΔT 50°C Watts/BTU's	Output ΔT 60°C BTU's	Price (ex VAT) Chrome	Price (inc VAT) Chrome	Stock or made to order
	H	W	D								
DR012	900	500	170	4-4-10	300	150	417 / 1423	1798	396.00	475.20	✓
DR012	1200	500	170	4-4-4-11	300	200	556 / 1897	2398	480.00	576.00	✓

Cygnus Harmonique

Wall Mounted DR032

A unique looped rail encompassing a vertical contemporary radiator adds a beautifully contemporary feel to any space. The coiled bars bring an intricacy whilst providing abundant towel hanging space.



Manufactured from high quality mild steel. Prices shown are chrome finish for central heating models. Please Note: Colour option only applies to the inset radiator, not the frame.



For electric element & valve options see pages 154 & 160 VL003

MS C D E

Cygnus Harmonique

Tube diameter Ø 19 + 32mm	Dimensions (mm)			Bar Config	Pipe Centres	Electric element wattage	Output ΔT 50°C Watts/BTU's	Output ΔT 60°C BTU's	Price (ex VAT) Chrome	Price (inc VAT) Chrome	Stock or made to order
	H	W	D								
DR032	1200	500	159-174	23	300	400	908 / 3098	3916	1045.00	1254.00	✓

Draco

Wall Mounted DR015

Draco's equally spaced hooped tubes form an architectural shape. Perfect symmetry with centralised valves. Finished in chrome, a must for any modern setting. Manufactured from high quality mild steel. Prices shown are chrome finish for central heating models.



MS C D E

Draco

Tube diameter		Dimensions (mm)			Bar Config	Pipe Centres	Electric element wattage	Output ΔT 50°C Watts/BTU's	Output ΔT 60°C BTU's	Price (ex VAT) Chrome	Price (inc VAT) Chrome	Stock or made to order
∅	□	H	W	D								
19mm	30 x 30mm											
DR015		1000	500	160	9	86	125	236 / 805	1018	561.00	673.20	✓
DR015		1300	500	160	13	86	150	272 / 928	1173	594.00	712.80	✓

For electric element & valve options see pages 154 & 160



VL014

Sierra

Wall Mounted DR040

Unique design and bold tubes, the Sierra provides a statement product and increased towel drying capacity. Available in an Anthracite finish, manufactured in high quality mild steel. Prices shown are for central heating models.



MS C D E

Sierra

Tube diameter	Dimensions (mm)			Bar Config	Pipe Centres	Electric element wattage	Output ΔT 50°C Watts/BTU's	Output ΔT 60°C BTU's	Price (ex VAT) Anthracite	Price (inc VAT) Anthracite	Stock or made to order	
	□	H	W									D
35 x 35 + 60 x 12												
DR040		850	500	125	2+3+3	300	150	524 / 1788	2260	343.00	411.60	✓
DR040		1200	500	125	2+3+3+3	300	200	683 / 2330	2946	446.00	535.20	✓
DR040		1550	500	125	3+3+4+6	300	300	966 / 3296	4166	588.00	705.60	✓

For electric element & valve options see pages 154 & 160



VL003

Contrast

Wall Mounted MD079

Contrasting design with square mitred outer tubes and round cross bars. The Contrast is a hybrid product with 50mm or 450mm centres and the option for an electric element to go up the vertical square tube without the need for a conversion tee for dual fuel models.



Available in Matt Black and White Sparkle Textured finish. Prices shown are for central heating models.



For electric element & valve options see pages 154 & 160



Contrast

Tube diameter 50sq 38mm	Dimensions (mm)			Bar Config	Pipe Centres	Electric element wattage	Output ΔT 50°C Watts/BTU's	Output ΔT 60°C BTU's	Price (ex VAT) Matt Black or White Sparkle	Price (inc VAT) Matt Black or White Sparkle	Stock or made to order
	H	W	D								
MD079	800	500	105-120	3-7	50 / 450	300	447 / 1525	1928	390.00	468.00	✓
MD079	1200	500	105-120	3-5-7	50 / 450	400	628 / 2143	2708	486.00	583.20	✓
MD079	1500	500	105-120	3-4-5-7	50 / 450	600	770 / 2627	3321	552.00	662.40	✓

When space is limited but you still want good design and high heat output, the Intra ticks all the boxes. The towel rail fits neatly into a corner to maximise wall space and is available in two sizes. Manufactured from large diameter brass or mild steel tube.

Intra

Wall Mounted CN013



Mild Steel Metallic Finish Supplements

Gold - POA	
Bright Nickel - Chrome	£221.00 ex VAT, £265.20 inc VAT
Brushed Nickel - Chrome	£309.00 ex VAT, £370.80 inc VAT

Bespoke finishes are available at an additional cost. Please see pages 162 & 163 for finishes and colour options. Prices shown are chrome finished for central heating systems. Also available in brass, POA.



Intra - MS

Tube diameter 31.8 + 50.8mm	Dimensions (mm)			Bar Config	Pipe Centres	Electric element wattage	Output ΔT 50°C Watts/BTU's	Output ΔT 60°C BTU's	Price (ex VAT) Chrome	Price (inc VAT) Chrome	Stock or made to order
	H	W	D								
CN013-MS	1240	556	306	5-5-5	281 + 531	200	525 / 1791	2264	596.20	715.44	✓
CN013-MS	1680	556	306	5-5-5-5	281 + 531	300	703 / 2399	3032	725.00	870.00	✓

For electric element & valve options see pages 154 & 160



Grace

Wall Mounted MD067

Understated with great towel hanging functionality, Grace is the epitome of simple chic design. Manufactured from large diameter high quality mild steel. Prices shown are chrome finished for central heating models.



Mild Steel Metallic Finish Supplements
 Gold - POA
 Bright Nickel - Chrome £221.00 ex VAT, £265.20 inc VAT
 Brushed Nickel - Chrome £309.00 ex VAT, £370.80 inc VAT



Grace

Tube diameter Ø 38mm	Dimensions (mm)			Bar Config	Pipe Centres	Electric element wattage	Output ΔT 50°C Watts/BTU's	Output ΔT 60°C BTU's	Price (ex VAT) Chrome	Price (inc VAT) Chrome	Stock or made to order
	H	W	D								
MD067	800	500	100	3	462	100	140 / 478	604	270.00	324.00	✓
MD067	1200	500	100	4	462	125	199 / 679	858	301.00	361.20	✓

For electric element & valve options see pages 154 & 160



VL003

A simple yet sophisticated piece. With a chunky tube creating a robust and full bodied look, this will add a high quality and classy statement to your bathroom or en suite. Chromed to a mirror finish. Prices shown are chrome finished for all heating and hot water systems.

Mantra V

Wall Mounted CN075



Mantra V

Tube diameter Ø 32 + 51mm	Dimensions (mm)			Bar Config	Pipe Centres	Electric element wattage	Output ΔT 50°C Watts/BTU's	Output ΔT 60°C BTU's	Price (ex VAT) Chrome	Price (inc VAT) Chrome	Stock or made to order
	H	W	D								
CN075	1240	500	125	14	449	200	408 / 1392	1760	591.00	709.20	✓

For electric element & valve options see pages 154 & 160



VL003

Pure

Wall Mounted MD037

Pure high quality elegance. This hand-crafted towel rail is manufactured in brass and chromed to a mirror finish. Bespoke finishes are available at an additional cost. A perfect size for smaller areas where space is at a premium and quality a must.



Image showing Antique Bronze finish

Please see pages 162 & 163 for finishes and colour options. Prices shown are for chrome finished central heating models.



Pure

Tube diameter	Dimensions (mm)			Bar Config	Pipe Centres	Electric element wattage	Output ΔT 50°C Watts/BTU's	Output ΔT 60°C BTU's	Price (ex VAT) Chrome	Price (inc VAT) Chrome	Stock or made to order
	H	W	D								
MD037	700	425	75	4	400	75	106 / 362	457	737.00	884.40	👇

For electric element & valve options see pages 154 & 160



VL003

Amie

Wall Mounted CN065

A contemporary chrome oval tube towel warmer that can be left or right hand mounted. Manufactured from mild steel, suitable for closed heating systems.

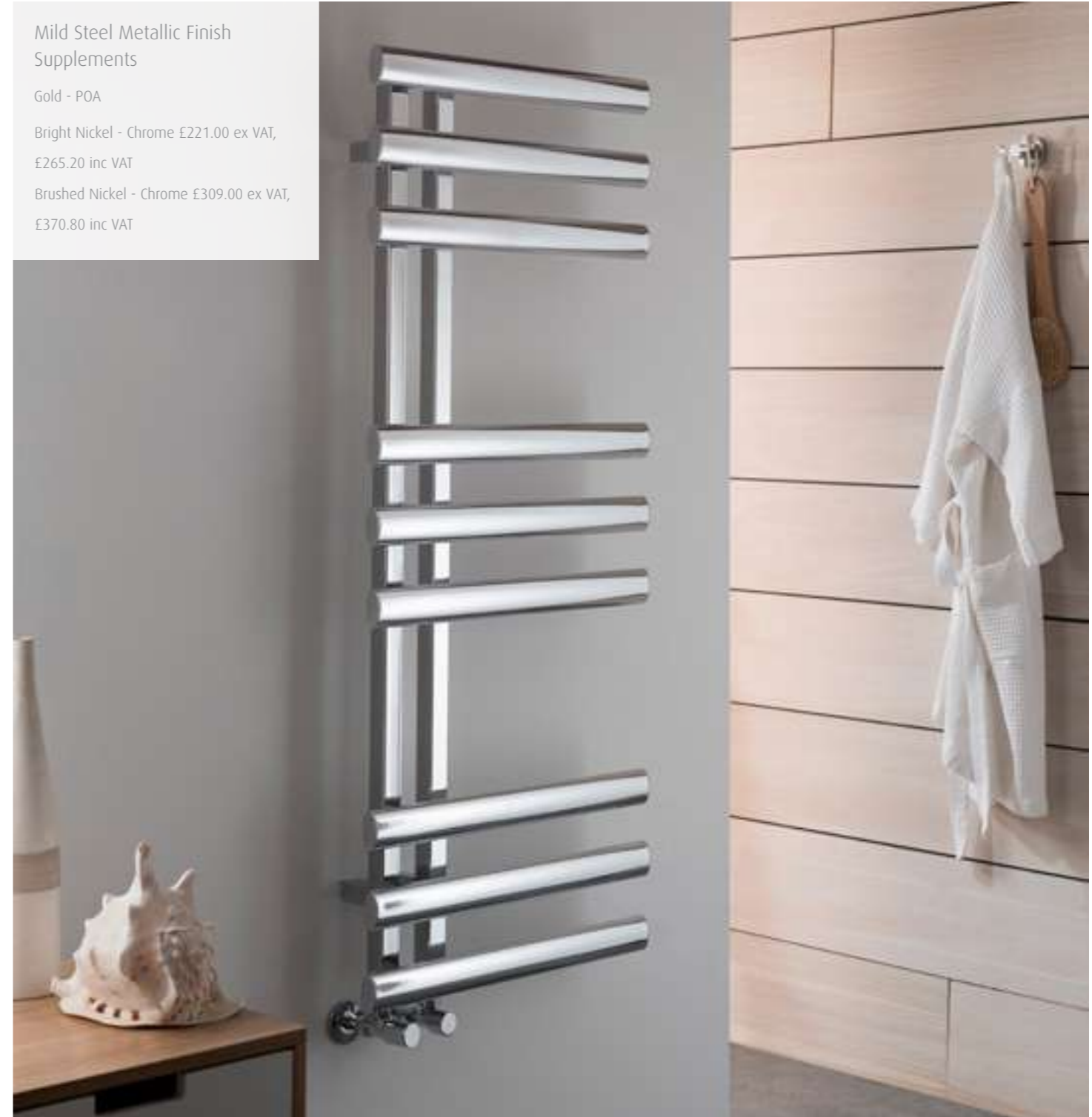

Mild Steel Metallic Finish Supplements

Gold - POA

Bright Nickel - Chrome £221.00 ex VAT, £265.20 inc VAT

Brushed Nickel - Chrome £309.00 ex VAT, £370.80 inc VAT

Please see pages 162 & 163 for finishes and colour options. Prices shown are for chrome finished central heating models.



Amie

Tube diameter	Dimensions (mm)			Bar Config	Pipe Centres	Electric element wattage	Output ΔT 50°C Watts/BTU's	Output ΔT 60°C BTU's	Price (ex VAT) Chrome	Price (inc VAT) Chrome	Stock or made to order
	H	W	D								
30 x 30 Sq + 25 x 50 Oval											
CN065	1200	500	125-137	3-3-3	80	200	237 / 809	1022	468.00	561.60	✓
CN065	1500	500	125-137	3-3-3-3	80	400	309 / 1054	1333	533.00	639.60	✓

For electric element & valve options see pages 154 & 160



VL003

Chic

Wall Mounted MD046

Chic gives ultimate versatility allowing towels to be accessed from the side. This practical and stylish design is available chrome plated. Manufactured from high quality mild steel which can be mounted to the left or right.



Mild Steel Metallic Finish Supplements
 Gold - POA
 Bright Nickel - Chrome £221.00 ex VAT, £265.20 inc VAT
 Brushed Nickel - Chrome £309.00 ex VAT, £370.80 inc VAT

Please see pages 162 & 163 for finishes and colour options. Prices shown are chrome finished for central heating models.



Chic

Tube diameter		Dimensions (mm)			Bar Config	Pipe Centres	Electric element wattage	Output ΔT 50°C Watts/BTU's	Output ΔT 60°C BTU's	Price (ex VAT) Chrome	Price (inc VAT) Chrome	Stock or made to order
\varnothing 22mm	30mm	H	W	D								
MD046		1200	500	85	3-3-3-3-3	100	150	282 / 962	1216	368.00	441.60	✓

VL014



For electric element & valve options see pages 154 & 160

Keys II

Wall Mounted CN030

A contemporary, minimalist design with crisp clean lines. Keys II allows towels to be effortlessly hung onto the rails from the left or right hand side, depending on your requirements. Manufactured from high quality mild steel, chromed to a mirror finish.

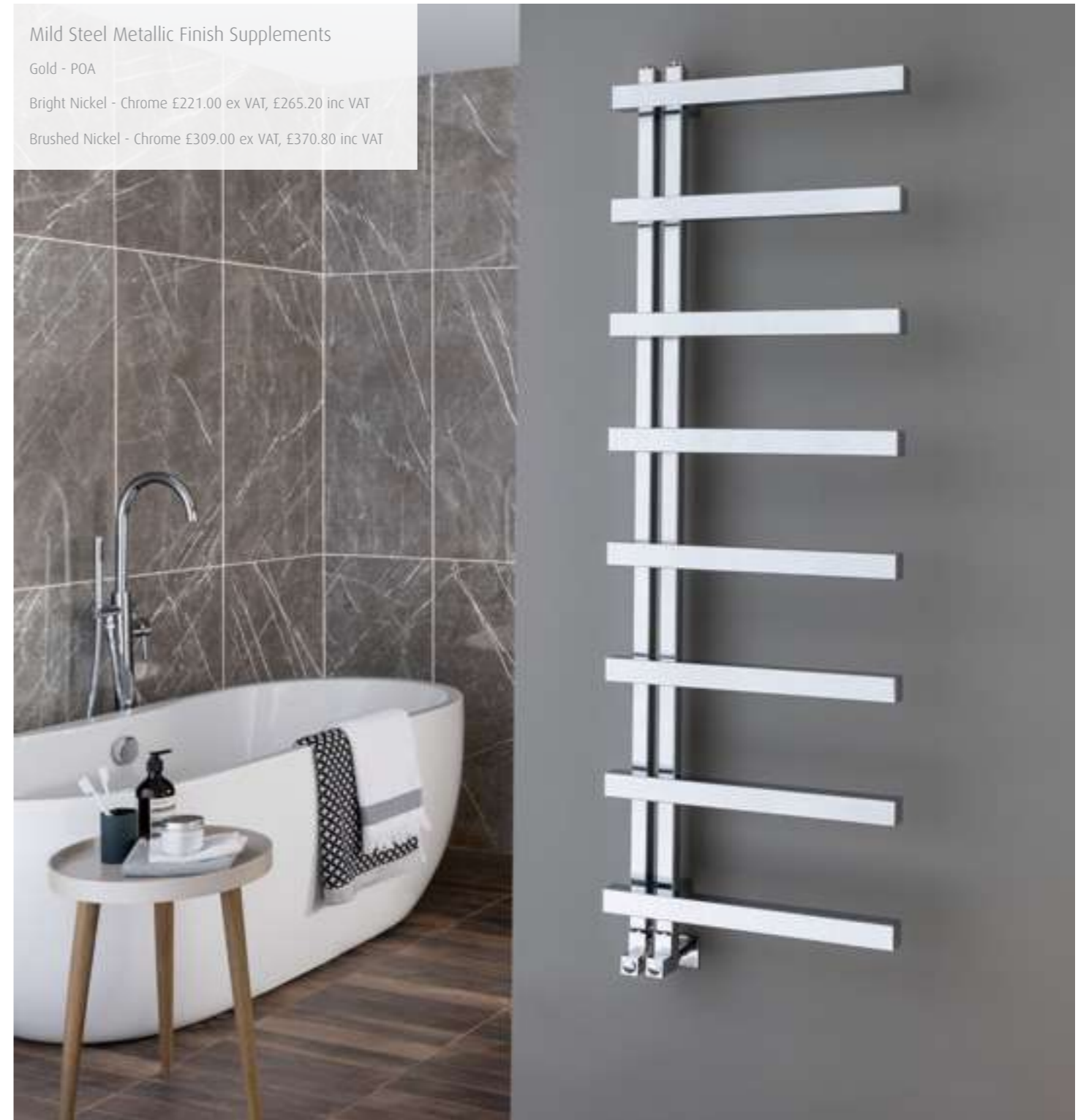

Mild Steel Metallic Finish Supplements
 Gold - POA
 Bright Nickel - Chrome £221.00 ex VAT, £265.20 inc VAT
 Brushed Nickel - Chrome £309.00 ex VAT, £370.80 inc VAT

Please see pages 162 & 163 for finishes and colour options. Prices shown are chrome finished for central heating models. Stainless Steel version available on request.



Keys II

Tube diameter	Dimensions (mm)			Bar Config	Pipe Centres	Electric element wattage	Output ΔT 50°C Watts/BTU's	Output ΔT 60°C BTU's	Price (ex VAT) Chrome	Price (inc VAT) Chrome	Stock or made to order
	H	W	D								
CN030	1080	500	141	6	50	150	392 / 1338	1691	522.00	626.40	✓
CN030	1460	500	141	8	50	200	524 / 1788	2260	690.00	828.00	✓

VL014



For electric element & valve options see pages 154 & 160

Smooth

Wall Mounted CN035

Smooth combines excellent towel hanging space with high heat output and eye catching design. Manufactured from high quality mild steel. Prices shown are chrome finished for central heating systems.



Mild Steel Metallic Finish Supplements
 Gold - POA
 Bright Nickel - Chrome £221.00 ex VAT, £265.20 inc VAT
 Brushed Nickel - Chrome £309.00 ex VAT, £370.80 inc VAT

Please see pages 162 & 163 for finishes and colour options. Prices shown are chrome finished for central heating models.



Smooth

Tube diameter Ø 32 + 22mm	Dimensions (mm)			Bar Config	Pipe Centres	Electric element wattage	Output ΔT 50°C Watts/BTU's	Output ΔT 60°C BTU's	Price (ex VAT) Chrome	Price (inc VAT) Chrome	Stock or made to order
	H	W	D								
CN035	800	400	94	9	368	100	163 / 556	703	489.00	586.80	✓
CN035	800	500	94	9	468	125	189 / 645	815	503.00	603.60	✓
CN035	1200	400	94	13	368	150	235 / 802	1014	613.00	735.60	✓
CN035	1200	500	94	13	468	150	271 / 925	1169	637.00	764.40	✓

For electric element & valve options see pages 154 & 160



VL003

Smooth II

Wall Mounted CN036

Smooth II is modern and stylish, featuring 38mm vertical tubes. Manufactured from high quality mild steel with mitred corners. Prices shown are chrome finished for central heating systems.

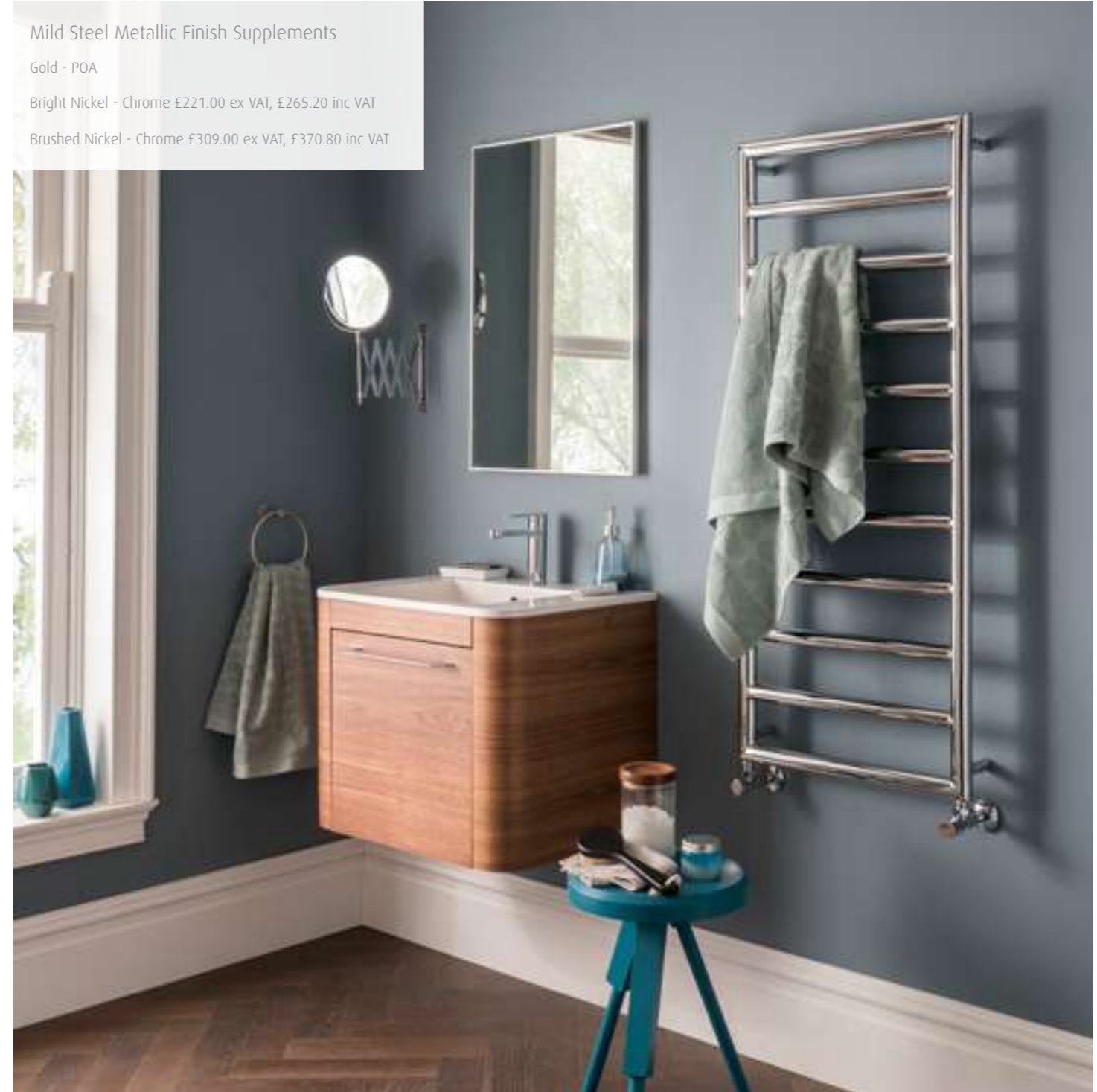

Mild Steel Metallic Finish Supplements
 Gold - POA
 Bright Nickel - Chrome £221.00 ex VAT, £265.20 inc VAT
 Brushed Nickel - Chrome £309.00 ex VAT, £370.80 inc VAT

Please see pages 162 & 163 for finishes and colour options. Prices shown are chrome finished for central heating models.



Smooth II

Tube diameter Ø 38 + 32mm	Dimensions (mm)			Bar Config	Pipe Centres	Electric element wattage	Output ΔT 50°C Watts/BTU's	Output ΔT 60°C BTU's	Price (ex VAT) Chrome	Price (inc VAT) Chrome	Stock or made to order
	H	W	D								
CN036	800	400	96	8	368	125	206 / 703	888	522.00	626.40	✓
CN036	800	500	96	8	468	150	237 / 809	1022	546.00	655.20	✓
CN036	1200	400	96	11	368	200	292 / 996	1259	652.00	782.40	✓
CN036	1200	500	96	11	468	200	335 / 1143	1445	682.00	818.40	✓

For electric element & valve options see pages 154 & 160



VL003

Arc Matt Black

Wall Mounted MD065

A matt black statement piece available in three size options. Manufactured from high quality mild steel. Prices shown are for central heating models in the matt black finish.



NEW Matt Black
January 2023

Arc has it all, ample towel hanging space and good heat output. Available in chrome to suit your ideal kitchen or bathroom. Manufactured from high quality mild steel. Prices shown are for central heating models in a chrome finish.

Arc

Wall Mounted MD065

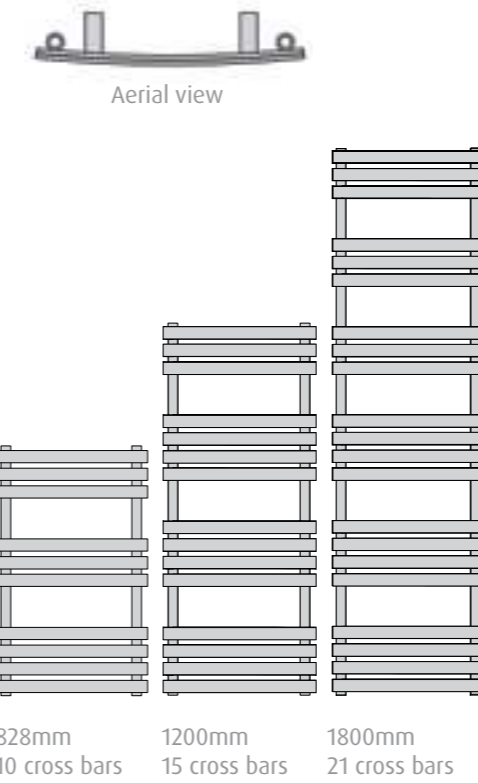

For electric element & valve options see pages 154 & 160  VL014

Mild Steel Metallic Finish Supplements
Gold - POA
Bright Nickel - Chrome £221.00 ex VAT, £265.20 inc VAT
Brushed Nickel - Chrome £309.00 ex VAT, £370.80 inc VAT

- MS
- C
- D
- E
- 

Arc Matt Black

Tube diameter ∅ 32mm 40 x 18mm	Dimensions (mm)			Bar Config	Pipe Centres	Electric element wattage	Output ΔT 50°C Watts/BTU's	Output ΔT 60°C BTU's	Price (ex VAT) Matt Black	Price (inc VAT) Matt Black	Stock or made to order
	H	W	D								
MD065	828	500	95	3-3-4	430	150	290 / 989	1254	325.00	390.00	✓
MD065	1200	500	95	3-4-4-4	430	300	432 / 1474	1868	412.00	494.40	✓
MD065	1800	500	95	3-3-3-4-4-4	430	400	614 / 2095	2654	520.00	624.00	✓

For electric element & valve options see pages 154 & 160  VL014

- MS
- C
- D
- E
- 

Arc

Tube diameter ∅ 32mm 40 x 18mm	Dimensions (mm)			Bar Config	Pipe Centres	Electric element wattage	Output ΔT 50°C Watts/BTU's	Output ΔT 60°C BTU's	Price (ex VAT) Chrome	Price (inc VAT) Chrome	Stock or made to order
	H	W	D								
MD065	828	500	95	3-3-4	430	150	232 / 792	1001	389.00	466.80	✓
MD065	1200	500	95	3-4-4-4	430	300	346 / 1181	1492	500.00	600.00	✓
MD065	1800	500	95	3-3-3-4-4-4	430	400	491 / 1675	2118	627.00	752.40	✓

Please see pages 162 & 163 for finishes and colour options. Prices shown are chrome finished for central heating models.

Quadrate

Wall Mounted MD074

Quadrate has 50mm vertical tubes and crisp, sleek edges, which would suit any modern bathroom setting. Available in a range of heights and widths. Manufactured from high quality mild steel. Prices are for chrome central heating models.



Mild Steel Metallic Finish Supplements
Bright Nickel - Chrome £221.00 ex VAT, £265.20 inc VAT

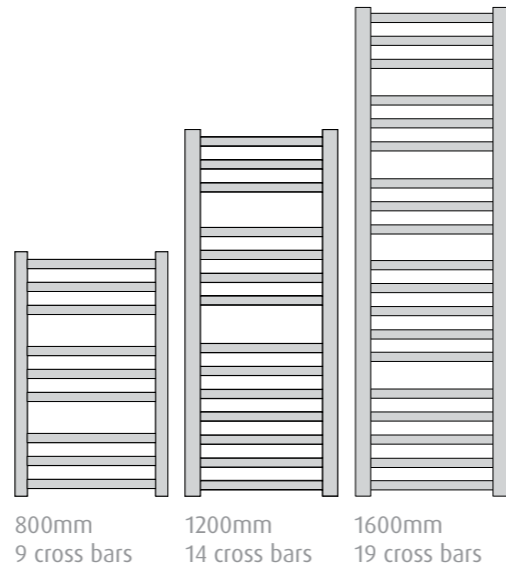

Please see pages 162 & 163 for finishes and colour options. Prices shown are chrome finished for central heating models.



For electric element & valve options see pages 154 & 160



Quadrate

Tube diameter 50sq + 30sq mm	Dimensions (mm)			Bar Config	Pipe Centres	Electric element wattage	Output ΔT 50°C Watts/BTU's	Output ΔT 60°C BTU's	Price (ex VAT) Chrome	Price (inc VAT) Chrome	Stock or made to order
	H	W	D								
MD074	800	500	105	3-3-3	450	150	271 / 925	1169	451.00	541.20	✓
MD074	800	600	105	3-3-3	550	200	310 / 1058	1337	473.00	567.60	✓
MD074	1200	500	105	3-4-7	450	300	416 / 1419	1794	587.00	704.40	✓
MD074	1200	600	105	3-4-7	550	300	477 / 1628	2057	625.00	750.00	✓
MD074	1600	500	105	3-3-3-5-5	450	400	561 / 1914	2419	723.00	867.60	✓
MD074	1600	600	105	3-3-3-5-5	550	600	645 / 2201	2782	772.00	926.40	✓

A striking, functional product with high heat output and multiple crossbars for optimum towel hanging capabilities. The square tubing gives a contemporary look for a clean profile.

Quadrate Harmonique

Wall Mounted MD078



Please see pages 162 & 163 for finishes and colour options. Prices shown are chrome finish for central heating models. Please Note: Colour option only applies to the inset radiator, not the frame.



Quadrate Harmonique

Tube diameter 50sq + 30sq mm	Dimensions (mm)			Bar Config	Pipe Centres	Electric element wattage	Output ΔT 50°C Watts/BTU's	Output ΔT 60°C BTU's	Price (ex VAT) Chrome	Price (inc VAT) Chrome	Stock or made to order
	H	W	D								
MD078	1200	500	105-120	7	450	400	1003 / 3422	4326	688.00	825.60	✓

For electric element & valve options see pages 154 & 160



Rubik

Wall Mounted MD038

Simple and beautiful, the rectangular stainless steel tube is built to last. The Rubik comes in polished stainless steel as standard. Stainless steel construction is suitable for all hot water systems.

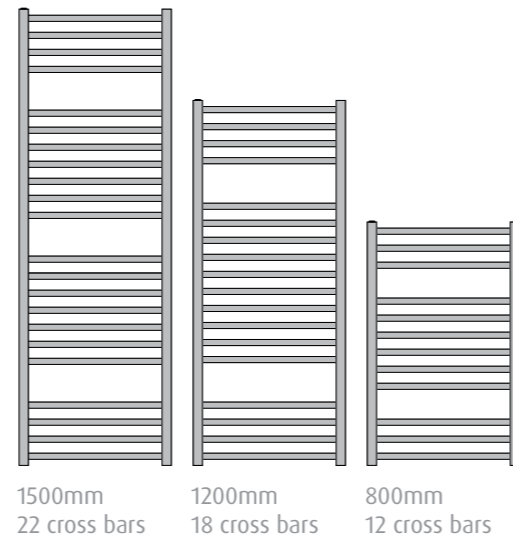

1500mm 22 cross bars
1200mm 18 cross bars
800mm 12 cross bars

Please see pages 162 & 163 for finishes and colour options. Prices shown are chrome finished for central heating models.



For electric element & valve options see pages 154 & 160 VL014



Rubik

Tube diameter 30sq + 20sq mm	Dimensions (mm)			Bar Config	Pipe Centres	Electric element wattage	Output ΔT 50°C Watts/BTU's	Output ΔT 60°C BTU's	Price (ex VAT) Brushed or Polished	Price (inc VAT) Brushed or Polished	Stock or made to order
	H	W	D								
MD038	800	500	80	3-6-3	470	200	404 / 1378	1742	1078.00	1293.60	🚫
MD038	1200	500	80	4-10-4	470	300	607 / 2071	2618	1386.00	1663.20	🚫
MD038	1500	500	80	4-7-7-4	470	300	747 / 2549	3222	1635.00	1962.00	🚫

Modern looks from this square tubed design brings together aesthetics and practicality. This versatile product will suit any modern bathroom. Chromed to a mirrored or anthracite finish. Prices shown are for central heating models.

Squire

Wall Mounted MD047

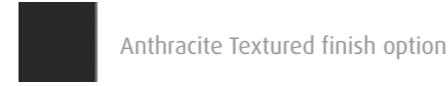

Anthracite Textured finish option

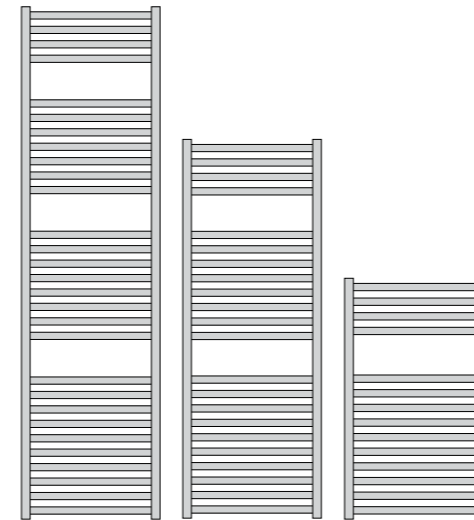

1770mm 29 cross bars
1322mm 22 cross bars
830mm 14 cross bars

Please see pages 162 & 163 for finishes and colour options. Prices shown are chrome finished for central heating models.

Mild Steel Metallic Finish Supplements

Gold - POA

Bright Nickel - Chrome £221.00 ex VAT, £265.20 inc VAT

Brushed Nickel - Chrome £309.00 ex VAT, £370.80 inc VAT



Squire

Tube diameter 30sq + 25sq mm	Dimensions (mm)			Bar Config	Pipe Centres	Electric element wattage	Output ΔT 50°C Watts/BTU's		Output ΔT 60°C Watts		Price Chrome		Price Anthracite		Stock or made to order
	H	W	D				chrome	painting	chrome	painting	ex VAT	inc VAT	ex VAT	inc VAT	
MD047	830	480	90	4-10	450	150	278 / 949	416 / 1419	1199	1794	321.00	385.20	214.00	256.80	✓
MD047	830	580	90	4-10	550	200	331 / 1129	495 / 1689	1428	2135	351.00	421.20	235.00	282.00	✓
MD047	1322	480	90	4-8-10	450	300	440 / 1501	656 / 2238	1898	2829	425.00	510.00	281.00	337.20	✓
MD047	1322	580	90	4-8-10	550	300	523 / 1784	780 / 2661	2256	3364	457.00	548.40	305.00	366.00	✓
MD047	1770	480	90	4-7-8-10	450	400	581 / 1982	868 / 2962	2506	3743	546.00	655.20	344.00	412.80	✓
MD047	1770	580	90	4-7-8-10	550	600	691 / 2358	1032 / 3521	2980	4451	575.00	690.00	366.00	439.20	✓

For electric element & valve options see pages 154 & 160 VL014



Serene

Wall Mounted MD049

The Serene is just that. A well balanced design which maximises hanging space. A perfect towel warmer for contemporary kitchens and bathrooms alike. Square tubes finished with a choice of chrome or contemporary finishes. Please see page 162 for colour options.

Image showing Anthracite finish

Contemporary Finishes

- Grey Sparkle Textured
- White Sparkle Textured
- Matt Black
- Satin Black
- Anthracite Textured
- Espresso Gloss
- Mocha Textured
- Cappuccino Textured
- Latte Textured
- Steel Blue
- Moss Green



Mild Steel Metallic Finish Supplements

Gold - POA

Bright Nickel - Chrome £221.00 ex VAT, £265.20 inc VAT

Brushed Nickel - Chrome £309.00 ex VAT, £370.80 inc VAT

Prices shown are for central heating models.



Serene

Tube diameter	Dimensions (mm)			Bar Config	Pipe Centres	Electric element wattage	Output ΔT 50°C		Output ΔT 60°C		Price Chrome		Price White		Price Colours		Stock or made to order	
	H	W	D				chrome	painted	chrome	painted	(ex VAT)	(inc VAT)	(ex VAT)	(inc VAT)	(ex VAT)	(inc VAT)		(ex VAT)
25sq + 30sq mm																		
MD049	1000	500	85	12	470	150	257 / 877	409 / 1396	1108	1764	373.00	447.60	249.00	298.80	425.00	510.00		
MD049	1165	500	85	15	470	200	314 / 1071	420 / 1433	1354	1811	406.00	487.20	273.00	327.60	453.00	543.60		
MD049	1165	600	85	15	570	300	365 / 1245	437 / 1491	1574	1885	446.00	535.20	299.00	358.80	495.00	594.00		
MD049	1700	500	85	20	470	300	434 / 1481	501 / 1709	1872	2161	574.00	631.20	381.00	457.20	566.00	679.20		
MD049	1700	600	85	20	570	400	520 / 1774	601 / 2051	2243	2592	521.00	688.80	346.00	415.20	594.00	712.80		

For electric element & valve options see pages 154 & 160



VL014

Ideal

Wall Mounted MD055

A contemporary, minimalist design with crisp edges and clean lines. The Ideal is manufactured in high quality stainless steel which is polished to perfection. Stainless steel construction is suitable for all hot water systems.



Ideal

Tube diameter	Dimensions (mm)			Bar Config	Pipe Centres	Electric element wattage	Output ΔT 50°C	Output ΔT 60°C	Price (ex VAT)		Price (inc VAT)		Stock or made to order
	H	W	D						Brushed or Polished	Brushed or Polished	Brushed or Polished	Brushed or Polished	
30sq + 20sq mm													
MD055	900	500	100	3-3	470	100	281 / 959	1212	681.00	817.20	✓		
MD055	1200	500	100	4-4	470	125	375 / 1280	1617	763.00	915.60	✓		
MD055	1500	500	100	5-5	470	150	469 / 1600	2023	894.00	1072.80	✓		

For electric element & valve options see pages 154 & 160



VL014

Boxa

Wall Mounted CN009

Boxa is crafted using large gauge square and rectangular tubing with smooth rounded corners. A perfect blend of form and function. Available in three heights to suit the size of your room.



Mild Steel Metallic Finish Supplements

Gold - POA

Bright Nickel - Chrome £221.00 ex VAT, £265.20 inc VAT

Brushed Nickel - Chrome £309.00 ex VAT, £370.80 inc VAT

Prices shown are for chrome models.



Boxa - MS

Tube diameter	Dimensions (mm)			Bar Config	Pipe Centres	Electric element wattage	Output ΔT 50°C Watts/BTU's	Output ΔT 60°C BTU's	Price (ex VAT) Chrome	Price (inc VAT) Chrome	Stock or made to order
	H	W	D								
40sq x 40 + 20sq mm											
CN009A - MS	620	450	120	3	410	100	199 / 679	858	481.00	577.20	✓
CN009B - MS	1060	450	120	5	410	150	290 / 989	1251	558.00	669.60	✓
CN009C - MS	1500	450	120	7	410	200	437 / 1491	1885	630.00	756.00	✓

For electric element & valve options see pages 154 & 160



VL014

Zenith is beautifully handcrafted in high quality stainless steel and has a brushed or polished finish, suitable for all heating & hot water systems.

Zenith

Wall Mounted IN007



Zenith

Tube diameter	Dimensions (mm)			Bar Config	Pipe Centres	Electric element wattage	Output ΔT 50°C Watts/BTU's	Output ΔT 60°C BTU's	Price £ (ex VAT) Brushed or Polished	Price £ (inc VAT) Brushed or Polished	Stock or made to order
	H	W	D								
40sq + 30sqmm											
IN007	1200	400	90	6	360	125	421 / 1436	1816	1581.00	1897.20	✗

For electric element & valve options see pages 154 & 160



VL003

Gallant

Wall Mounted MD040SS

Crafted in high quality stainless steel the Gallant is a bold stylish piece offering crisp right angles to stunning effect. Available in two heights in polished stainless steel, suitable for all hot water systems. Please see page 162 for colour options.

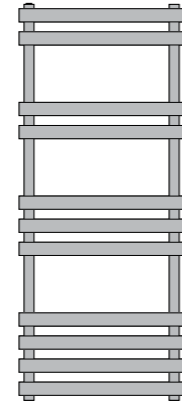

1200mm
11 cross bars

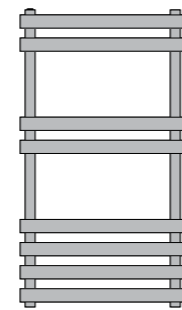

900mm
8 cross bars



For electric element & valve options see pages 154 & 160



Gallant

Tube diameter	Dimensions (mm)			Bar Config	Pipe Centres	Electric element wattage	Output ΔT 50°C Watts/BTU's	Output ΔT 60°C BTU's	Price (ex VAT) Brushed or Polished	Price (inc VAT) Brushed or Polished	Stock or made to order
	H	W	D								
30sq + 40 x 20sq mm											
MD040SS	900	500	97	2-2-4	440	200	458 / 1563	1975	1236.00	1483.20	👤
MD040SS	1200	500	97	2-2-3-4	440	300	624 / 2129	2691	1505.00	1806.00	👤

Gallant II

Wall Mounted MD040MS

The square tubed design is manufactured from high quality mild steel and will suit any modern bathroom. Prices shown are for central heating models. Available in matt black or chrome.



NEW Matt Black
January 2023



Chrome Gallant II is available for immediate despatch.

Gallant II

Tube diameter	Dimensions (mm)			Bar Config	Pipe Centres	Electric element wattage	Output ΔT 50°C Watts/BTU's		Output ΔT 60°C BTU's		Price (ex VAT) Matt Black	Price (inc VAT) Matt Black	Price (ex VAT) Chrome	Price (inc VAT) Chrome	Stock or made to order	
	∅	□	H				W	D	Chrome	Matt Black						Chrome
35mm	35 x 20mm															
MD040MS		900	500	101	2-2-4	450	200	229 / 781	286 / 976	990	1235	205.00	246.00	498.00	597.60	✓
MD040MS		1200	500	101	2-2-3-4	450	300	312 / 1063	390 / 1331	1347	1682	254.00	304.80	589.00	706.80	✓

For electric element & valve options see pages 154 & 160



Aquila

Wall Mounted DR016

Rectangular tube towel rail provides ample space and heat for warming or drying towels, in a design which allows you to slide them effortlessly into place from either the left or right, depending on your preference. Manufactured from high quality mild steel.



Prices shown are chrome or matt black finished for central heating models. Please see page 162 for further colour options.



Matt black finish



VL014



For electric element & valve options see pages 154 & 160

Aquila

Tube diameter	Dimensions (mm)			Bar Config	Pipe Centres	Electric element wattage	Output ΔT 50°C		Output ΔT 60°C		Price ex VAT	Price inc VAT	Price ex VAT	Price inc VAT	Stock or made to order
	H	W	D				Chrome	Matt Black	Chrome	Matt Black					
40 x 10 + 30 x 30mm															
DR016	1200	500	118	3-3-3-3-3	60	150	354 / 1208	442 / 1508	1527	1911	522.00	626.40	414.00	496.80	✓
DR016	1400	600	118	3-3-3-3-3-3	60	200	436 / 1488	545 / 1859	1880	2355	577.00	692.40	464.00	556.80	✓

Phoenix

Wall Mounted DR017

Asymmetric rectangular tube towel rails give a fascinating design that has clean lines and simple access from either side. Manufactured from high quality mild steel, prices shown are chrome finished for central heating models.



Please see pages 162 & 163 for finishes and colour options. Prices shown are chrome finished for central heating models.



For electric element & valve options see pages 154 & 160

Phoenix

Tube diameter	Dimensions (mm)			Bar Config	Pipe Centres	Electric element wattage	Output ΔT 50°C	Output ΔT 60°C	Price ex VAT	Price inc VAT	Stock or made to order
	H	W	D								
40 x 10 + 30 x 30mm											
DR017	1200	500	118	3-3-3-3-3	60	150	301 / 1027	1298	479.00	574.80	✓

Curvee is stylish and practical. As the name suggests, the cross rails are gently bowed. The towel rail offers good heat output in four sizes, the 1100mm version is pictured. Available in chrome or white finish. Please see page 162 for colour options.

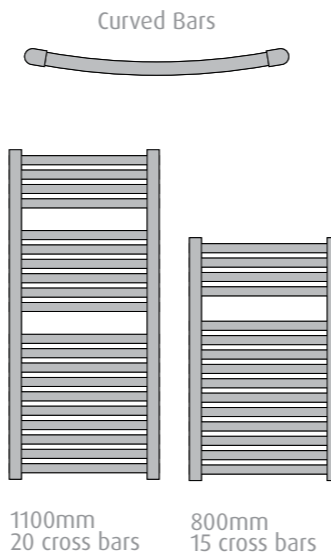

Mild Steel Metallic Finish Supplements

- Gold - POA
- Bright Nickel - Chrome £221.00 ex VAT, £265.20 inc VAT
- Brushed Nickel - Chrome £309.00 ex VAT, £370.80 inc VAT



Prices shown are chrome or white for central heating models.



Curvee

Tube diameter 15 x 30 + 30 x 40mm	Dimensions (mm)			Bar Config	Pipe Centres	Electric element wattage	Output ΔT 50°C Watts/BTU's		Output ΔT 60°C BTU's		Price Chrome		Price White		Stock or made to order
	H	W	D				chrome	paint	chrome	paint	ex VAT	inc VAT	ex VAT	inc VAT	
MD050	800	500	96	4-11	455	125	235 / 802	543 / 1853	1014	2342	262.00	314.40	168.00	201.60	✓
MD050	800	600	96	4-11	555	150	274 / 935	556 / 1897	1182	2398	288.00	345.60	195.00	234.00	✓
MD050	1100	500	96	4-6-10	455	200	316 / 1078	583 / 1989	1363	2514	366.00	439.20	236.00	283.20	✓
MD050	1100	600	96	4-6-10	555	300	387 / 1320	587 / 2003	1669	2532	390.00	468.00	260.00	312.00	✓

For electric element & valve options see pages 154 & 160

Rectangular crossbars give a solid feel to this design. Available in two sizes finished in your choice of chrome, white or a contemporary colour. Prices shown are for central heating models. Please see page 162 for colour options.

Contemporary Finishes

- Grey Sparkle Textured
- White Sparkle Textured
- Matt Black
- Satin Black
- Anthracite Textured
- Espresso Gloss
- Mocha Textured
- Cappuccino Textured
- Latte Textured
- Steel Blue
- Moss Green



Mild Steel Metallic Finish Supplements

- Gold - POA
- Bright Nickel - Chrome £221.00 ex VAT, £265.20 inc VAT
- Brushed Nickel - Chrome £309.00 ex VAT, £370.80 inc VAT



For electric element & valve options see pages 154 & 160



Vela

Tube diameter 38mm 60 x 10mm	Dimensions (mm)			Bar Config	Pipe Centres	Electric element wattage	Output ΔT 50°C Watts/BTU's		Output ΔT 60°C BTU's		Price Chrome		Price White		Price Colours		Stock or made to order
	H	W	D				chrome	paint	chrome	paint	ex VAT, inc VAT	ex VAT, inc VAT	ex VAT, inc VAT	ex VAT, inc VAT			
MD048	950	500	101	2-3-4	462	125	246 / 839	289 / 986	1061	1246	399.00	478.80	267.00	320.40	487.00	584.40	⚙️
MD048	1300	500	101	3-5-5	462	200	330 / 1126	389 / 1327	1423	1678	634.00	760.80	399.00	478.80	670.00	804.00	⚙️

Décor

Wall Mounted MD084

A memorable design, available in two sizes. Suitable for any modern bathroom. Chromed to a mirror finish. Prices shown are for central heating models.



Mild Steel Metallic Finish Supplements
 Gold - POA
 Bright Nickel - Chrome £221.00 ex VAT, £265.20 inc VAT
 Brushed Nickel - Chrome £309.00 ex VAT, £370.80 inc VAT

Please see pages 162 & 163 for finishes and colour options. Prices shown are chrome finished for central heating models.



For electric element & valve options see pages 154 & 160  VL003

Tube diameter	Dimensions (mm)			Bar Config	Face to Face connections	Output ΔT 50°C Watts/BTU's	Output ΔT 60°C BTU's	Price (ex VAT) Chrome	Price (inc VAT) Chrome	Stock or made to order
	H	W	D							
40 x 20 + 40 x 10mm										
MD084	750	450	145	4	388	129 / 440	556	374.00	448.80	✓
MD084	1200	450	145	6	388	199 / 679	858	444.00	532.80	✓

Décor Harmonique

Wall Mounted MD094

Our Décor Harmonique is a stylish combination towel warmer, with flat horizontal bars and a contemporary look. It is designed for high heat output. Its modern sleek look brings an air of sophistication to any setting.



Please see pages 162 & 163 for finishes and colour options. Prices shown are chrome finish for central heating models. Please Note: Colour option only applies to the inset radiator, not the frame.



For electric element & valve options see pages 154 & 160  VL003

Tube diameter	Dimensions (mm)			Bar Config	Face to Face connections	Electric Element Wattage	Output ΔT 50°C Watts/BTU's	Output ΔT 60°C BTU's	Price (ex VAT) Chrome	Price (inc VAT) Chrome	Stock or made to order
	H	W	D								
40 x 20 + 40 x 10mm											
MD094	1200	500	159	4	442	200	842 / 2873	3631	727.00	872.40	✓

Unique

Wall Mounted CN028

Contemporary Towel Warmer with cylindrical features. Made from high quality mild steel. Prices shown are chrome finished for central heating models.



Mild Steel Metallic Finish Supplements

Gold - POA

Bright Nickel -

Chrome £221.00 ex VAT,
£265.20 inc VAT

Brushed Nickel -

Chrome £309.00 ex VAT,
£370.80 inc VAT

Please see pages 162 & 163 for finishes and colour options.



Unique

Tube diameter	Dimensions (mm)			Bar Config	Pipe centres	Electric Element Wattage	Output ΔT 50°C Watts/BTU's	Output ΔT 60°C BTU's	Price (ex VAT) Chrome	Price (inc VAT) Chrome	Stock or made to order
	H	W	D								
∅ 25.4mm	H	W	D								
CN028	950	500	90	4	460	125	155 / 529	668	503.00	603.60	✓

For electric element & valve options see pages 154 & 160



VL003

Venture is available in three widths and four heights, with spacious hanging bars. The bold jointed design suits contemporary interiors. Manufactured from high quality brass, chromed to a mirror finish. Please see pages 162 & 163 for finishes and colour options.

Venture

Wall Mounted CN022



Romolo Joint

For electric element & valve options see pages 154 & 160



VL003



Venture

Tube diameter	Dimensions (mm)			Bar Config	Pipe centres	Electric Element Wattage	Output ΔT 50°C Watts/BTU's	Output ΔT 60°C BTU's	Price (ex VAT) Chrome	Price (inc VAT) Chrome	Stock or made to order
	H	W	D								
∅ 25.4 + 22mm	H	W	D								
CN022	750	450	95	4	400	75	121 / 413	522	910.00	1092.00	✓
CN022	850	650	95	4	600	100	157 / 536	677	952.00	1142.40	✘
CN022	1300	500	95	6	450	125	206 / 703	888	1175.00	1410.00	✘
CN022	1300	650	95	6	600	125	240 / 819	1035	1195.00	1434.00	✘
CN022	1600	500	95	8	450	150	267 / 911	1152	1265.00	1518.00	✘
CN022	1600	650	95	8	600	150	312 / 1065	1346	1391.00	1669.20	✘

Vivid

Wall Mounted CN021

Vivid is a beautiful minimalistic towel warmer, manufactured from high quality brass. Prices shown are for chrome heating and hot water systems. Please see pages 160 & 161 for finishes and colour options.



Vivid

Tube diameter Ø 25.4 + 22mm	Dimensions (mm)			Bar Config	Pipe centres	Electric Element Wattage	Output ΔT 50°C Watts/BTU's	Output ΔT 60°C BTU's	Price (ex VAT) Chrome	Price (inc VAT) Chrome	Stock or made to order
	H	W	D								
CN021	750	450	93	4	400	75	121 / 413	522	785.00	942.00	✓
CN021	800	650	93	4	600	100	154 / 525	664	868.00	1041.60	✘
CN021	1250	500	93	6	450	125	201 / 686	867	1008.00	1209.60	✓
CN021	1250	650	93	6	600	125	235 / 802	1014	1027.00	1232.40	✘
CN021	1550	500	93	8	450	150	258 / 880	1113	1173.00	1407.60	✘
CN021	1550	650	93	8	600	150	303 / 1034	1307	1209.00	1450.80	✘

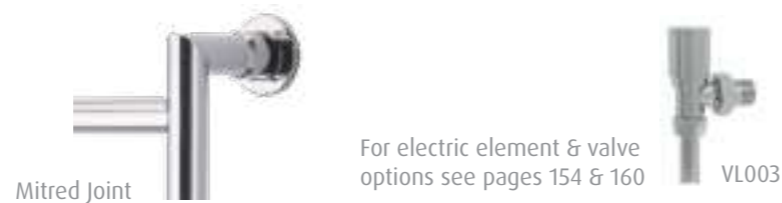

Mitred Joint

For electric element & valve options see pages 154 & 160

VL003

Vivid II

Wall Mounted CN029

Vivid II is a simplistic alternative to our Vivid without the mitred corner joints manufactured from high quality brass. Prices shown are for chrome heating and hot water systems.



Please see pages 162 & 163 for finishes and colour options.



Vivid II

Tube diameter Ø 25.4mm	Dimensions (mm)			Bar Config	Pipe centres	Electric Element Wattage	Output ΔT 50°C Watts/BTU's	Output ΔT 60°C BTU's	Price (ex VAT) Chrome	Price (inc VAT) Chrome	Stock or made to order
	H	W	D								
CN029	700	500	94	4	450	75	138 / 471	595	763.00	915.60	✘
CN029	1100	500	94	5	450	125	189 / 645	815	895.00	1074.00	✘
CN029	1400	500	94	6	450	150	232 / 792	1001	1058.00	1269.60	✘

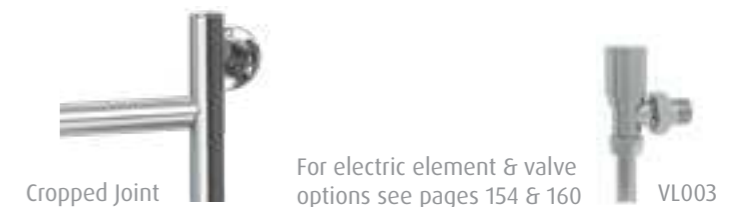

Cropped Joint

For electric element & valve options see pages 154 & 160

VL003

Vivid Integral Valve

Wall Mounted IVCN021

Vivid IV has all the stunning looks of Vivid with the added feature of built in integral valves. Manufactured from high quality brass with a chrome mirror finish.



Prices shown are for chrome heating and hot water systems. This radiator is also available on previous page with standard valves. Please see pages 162 & 163 for finishes and colour options. Pipe work is hidden in the wall. We recommend using service valves as part of the installation. Please consult your installer for the suitability of a brick wall installation.



Vivid Integral Valve

Tube diameter ∅ 25.4mm	Dimensions (mm)			Bar Config	Pipe centres	Output ΔT 50°C Watts/BTU's	Output ΔT 60°C BTU's	Price (ex VAT) Chrome	Price (inc VAT) Chrome	Stock or made to order
	H	W	D							
IVCN021	700	500	94	4	450	138 / 471	595	859.00	1030.80	👉
IVCN021	1100	500	94	5	450	189 / 645	815	938.00	1125.60	👉
IVCN021	1400	500	94	6	450	232 / 792	1001	1058.00	1269.60	👉

Simple and beautiful, this design manufactured from high quality brass, is perfect at the side of a shower.

Simplicity Integral Valve

Wall Mounted IVCN026

Integral Valve Fitting

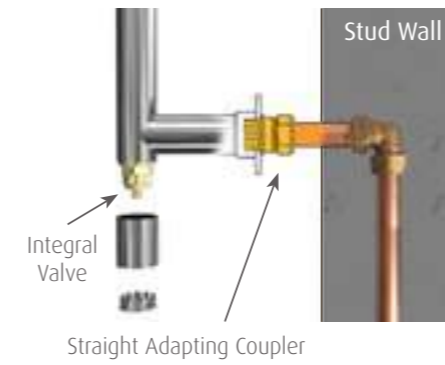

Prices shown are chrome finished for all heating and hot water systems. Please see pages 162 & 163 for finishes and colour options. Pipe work is hidden in the wall. We recommend using service valves as part of the installation. Not suitable for brick walls.



Simplicity Integral Valve

Tube diameter ∅ 25.4mm	Dimensions (mm)			Bar Config	Pipe centres	Output ΔT 50°C Watts/BTU's	Output ΔT 60°C BTU's	Price (ex VAT) Chrome	Price (inc VAT) Chrome	Stock or made to order
	H	W	D							
IVCN026	1700	50	115	1	1625	75 / 256	323	681.00	817.20	👉

Vivid Integral Valve

Wall Mounted IVCN021

Vivid IV horizontal is the ideal choice over a bath or underneath a window. The single bar versions are perfect for en-suites and small spaces. Manufactured from high quality brass with built in valves.



Image showing Polished Brass finish

Prices shown are chrome finished for all heating and hot water systems. Please see pages 162 & 163 for finishes and colour options. Pipe work is hidden in the wall. We recommend using service valves as part of the installation. Not suitable for brick walls.



Vivid Integral Valve

Tube diameter Ø 25.4mm	Dimensions (mm)			Bar Config	Pipe centres	Output ΔT 50°C Watts/BTU's	Output ΔT 60°C BTU's	Price (ex VAT) Chrome	Price (inc VAT) Chrome	Stock or made to order
	H	W	D							
IVCN021 single bar	50	400	94	1	325	21 / 72	91	361.00	433.20	👤
IVCN021 single bar	50	600	94	1	525	30 / 102	129	374.00	448.80	👤

Vivid IV 3 bar version for additional towel drying capacity. Manufactured from high quality brass with built in integral valves.

Vivid Integral Valve

Wall Mounted IVCN021



Prices shown are chrome finished for all heating and hot water systems. Please see pages 162 & 163 for finishes and colour options. Pipe work is hidden in the wall. We recommend using service valves as part of the installation. Not suitable for brick walls.



Vivid Integral Valve

Tube diameter Ø 25.4mm	Dimensions (mm)			Bar Config	Pipe centres	Output ΔT 50°C Watts/BTU's	Output ΔT 60°C BTU's	Price (ex VAT) Chrome	Price (inc VAT) Chrome	Stock or made to order
	H	W	D							
IVCN021	400	1200	94	3	1150	183 / 624	789	731.00	877.20	👤

An alternative mild steel option to the Ieri brass model, offering a fixed shelf position for the added benefit of towel stacking or towel hanging space. Available in two height options to suit your space.



Mild Steel Metallic Finish Supplements
 Gold - POA
 Bright Nickel - Chrome £221.00 ex VAT, £265.20 inc VAT
 Brushed Nickel - Chrome £309.00 ex VAT, £370.80 inc VAT

Manufactured from high quality mild steel. Please see pages 162 & 163 for finishes and colour options. Prices shown are chrome finished for central heating models.



Ieri - MS

Tube diameter	Dimensions (mm)			Bar Config	Pipe Centres	Electric element wattage	Output ΔT 50°C Watts/BTU's	Output ΔT 60°C BTU's	Price (ex VAT) Chrome	Price (inc VAT) Chrome	Stock or made to order
	H	W	D								
∅ 32 + 25 + 19mm											
TM014-MS	750	525	265	5	240	100	173 / 590	746	582.00	698.40	✓
TM014-MS	1350	525	265	8	240	200	277 / 945	1195	692.00	830.40	✓

For electric element & valve options see pages 154 & 160



The integrated shelf in this curvaceous design has the added benefit of towel stacking as well as plentiful hanging space. Available in two height options to suit your space with an alternative shelf position which is optional on point of order.



Manufactured from high quality brass and chrome finished, with bespoke finishes available at an additional cost. Please see pages 162 & 163 for finishes and colour options. Prices shown are chrome finished for central heating models.

Please note shelf location may vary when electric model specified on Brass model



Ieri - BR

Tube diameter	Dimensions (mm)			Bar Config	Face to Face connections	Electric element wattage	Output ΔT 50°C Watts/BTU's	Output ΔT 60°C BTU's	Price (ex VAT) Chrome	Price (inc VAT) Chrome	Stock or made to order
	H	W	D								
∅ 25.4 + 22mm											
TM014	750	500	265	4	375	100	219 / 747	944	1143.00	1371.60	✘
TM014	1350	500	265	7	375	200	329 / 1123	1419	1248.00	1497.60	✘

For electric element & valve options see pages 154 & 160



Solo

Wall Mounted TR001

The single shelf towel rack, Solo is an ideal design for limited space. This design provides ease of access to your dry and warm towels.



Mild Steel Metallic Finish Supplements
 Gold - POA
 Bright Nickel - Chrome £221.00 ex VAT, £265.20 inc VAT
 Brushed Nickel - Chrome £309.00 ex VAT, £370.80 inc VAT

Manufactured from quality brass or mild steel and chromed to a mirror finish. Bespoke finishes are available at an additional cost. See page 162 for colour options. Prices shown are chrome finished for central heating models.



Solo - MS

Tube diameter Ø 25.4mm	Dimensions (mm)			Bar Config	Pipe Centres	Electric element wattage	Output ΔT 50°C Watts/BTU's	Output ΔT 60°C BTU's	Price (ex VAT) Chrome	Price (inc VAT) Chrome	Stock or made to order
	H	W	D								
TR001-MS	265	500	315	5	425	50	97 / 331	418	308.00	369.60	✓



Solo - BR

Tube diameter Ø 25.4mm	Dimensions (mm)			Bar Config	Pipe Centres	Electric element wattage	Output ΔT 50°C Watts/BTU's	Output ΔT 60°C BTU's	Price (ex VAT) Chrome	Price (inc VAT) Chrome	Stock or made to order
	H	W	D								
TR001	263	500	315	5	425	50	126 / 430	543	703.00	843.60	✘

For electric element & valve options see pages 154 & 160



VL003

Binary

Wall Mounted TR002

The double shelf towel rack Binary, is perfect for situations where space is at a premium and style is of priority. This clever design allows you to stack, roll or hang your towels, so they are always warm, dry and handy.



Mild Steel Metallic Finish Supplements
 Gold - POA
 Bright Nickel - Chrome £221.00 ex VAT, £265.20 inc VAT
 Brushed Nickel - Chrome £309.00 ex VAT, £370.80 inc VAT

Manufactured from quality brass or mild steel and chromed to a mirror finish. Bespoke finishes are available at an additional cost. Please see page 162 for colour options. Prices shown are chrome finished for central heating models.



Binary MS

Tube diameter Ø 25.4mm	Dimensions (mm)			Bar Config	Pipe Centres	Electric element wattage	Output ΔT 50°C Watts/BTU's	Output ΔT 60°C BTU's	Price (ex VAT) Chrome	Price (inc VAT) Chrome	Stock or made to order
	H	W	D								
TR002-MS	274	500	315	9	425	75	155 / 529	668	478.00	573.60	✓



Binary BR

Tube diameter Ø 25.4mm	Dimensions (mm)			Bar Config	Pipe Centres	Electric element wattage	Output ΔT 50°C Watts/BTU's	Output ΔT 60°C BTU's	Price (ex VAT) Chrome	Price (inc VAT) Chrome	Stock or made to order
	H	W	D								
TR002	275	500	315	9	425	75	224 / 764	966	930.00	1116.00	✘

For electric element & valve options see pages 154 & 160



VL003

Comby

Wall Mounted MD052

Comby is designed to provide completely adaptable towel hanging and storage space. Towels in use can be hung over the cross rails to dry, clean towels placed on the folding shelf. Chromed to a mirror or white painted finish. Prices shown are for central heating models.



The Comby is designed for efficient heating of your towels and will provide maximum heat output with the shelf in the open position (as illustrated). In the closed (down) position heating of the shelf is reduced.

MS C

Comby

Tube diameter 40 x 30 D Section + 22mm	Dimensions (mm)			Bar Config	Pipe Centres	Output ΔT 50°C Watts/BTU's		Output ΔT 60°C BTU's		Price Chrome		Price White		Stock or made to order
	H	W	D			Chrome	White	Chrome	White	(ex VAT)	(inc VAT)	(ex VAT)	(inc VAT)	
	MD052	1200	500			85-110	25	455	377 / 1286	507 / 1730	1626	2187	464.00	
MD052	1200	600	85-110	25	555	452 / 1542	683 / 2330	1949	2946	483.00	579.60	362.00	434.40	✓

For valve options see page 160  VL003

Harmonique Duo

Wall Mounted MD090

A modern chrome multi-rail towel warmer with folding shelf combined with a white double panel radiator giving high heat output and drying in a combined unit. Inset radiator available in other radiator RAL colours.



The Harmonique Duo is designed for efficient heating of your towels and will provide maximum heat output with the shelf in the open position (as illustrated). In the closed (down) position heating of the shelf is reduced. Manufactured from mild steel, suitable for closed heating systems. Please see page 162 for colour options. Please Note: Colour option only applies to the inset radiator, not the frame.

MS C

Harmonique Duo

Tube diameter 40 x 30 D Section + 22mm	Dimensions (mm)			Bar Config	Pipe Centres	Output ΔT 50°C Watts/BTU's		Output ΔT 60°C BTU's		Price (ex VAT) Chrome		Price (inc VAT) Chrome		Stock or made to order
	H	W	D			Chrome	White	(ex VAT)	(inc VAT)	(ex VAT)	(inc VAT)			
	MD090	1200	500			104	25	455	850 / 2900	3666	731.00	877.20	✓	
MD090	1200	600	104	25	555	1170 / 3992	5046	788.00	945.60	✓				

For valve options see page 160  VL003

Carina

Wall Mounted MD051

Carina offers curves that work perfectly with the bold tubular design. The towel rail maximises storage space with a top shelf. Finished in chrome to match your sanitaryware. Style and versatility for the most contemporary of settings. Manufactured from high quality mild steel.

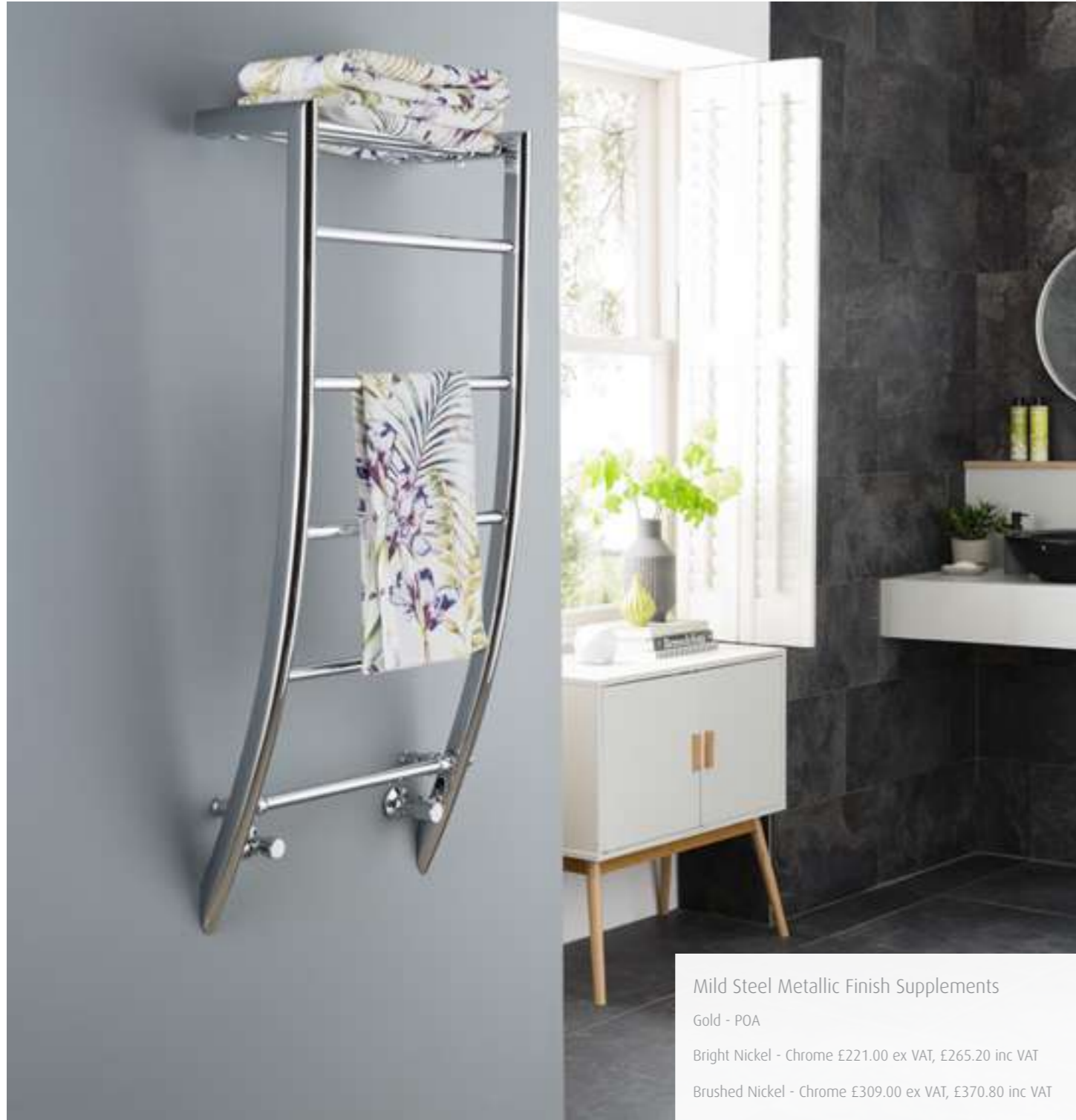

Mild Steel Metallic Finish Supplements
 Gold - POA
 Bright Nickel - Chrome £221.00 ex VAT, £265.20 inc VAT
 Brushed Nickel - Chrome £309.00 ex VAT, £370.80 inc VAT

Please see pages 162 & 163 for finishes and colour options.
 Prices shown are chrome finished for central heating models.

MS C D E

Carina

Tube diameter 22 + 40 x 30mm D Section	Dimensions (mm)			Bar Config	Face to Face connections	Electric element wattage	Output ΔT 50°C Watts/BTU's	Output ΔT 60°C BTU's	Price (ex VAT) Chrome	Price (inc VAT) Chrome	Stock or made to order
	H	W	D								
MD051	1200	500	225	8	422	125	223 / 761	962	515.00	618.00	✓
MD051	1200	600	225	8	522	150	243 / 829	1048	581.00	697.20	✓

For electric element & valve options see pages 154 & 160



A perfect combination for heating and drying. This versatile product will suit any modern bathroom. With a white double panelled radiator as standard and 25mm chrome horizontal tubes. Other radiator colours can be specified, please see page 162 for colour options.

Harmonique

Wall Mounted MD060

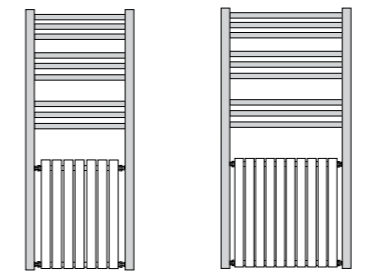

1200 x 500mm 7 Sections 1200 x 600mm 10 Sections

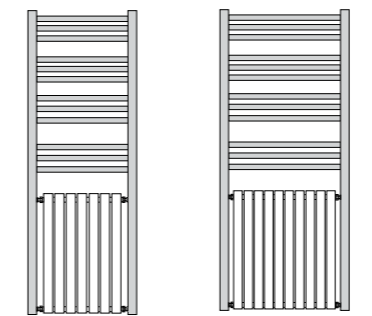

1500 x 500mm 7 Sections 1500 x 600mm 10 Sections

Mild Steel Metallic Finish Supplements
 Gold - POA
 Bright Nickel - Chrome £221.00 ex VAT, £265.20 inc VAT
 Brushed Nickel - Chrome £309.00 ex VAT, £370.80 inc VAT



For electric element & valve options see pages 154 & 160



Prices shown are for central heating models. Please Note: Colour option only applies to the inset radiator, not the frame.

MS C D E

Harmonique

Tube diameter 25 + 30 x 40mm D Section	Dimensions (mm)			Bar Config	Pipe Centres	Electric element wattage	Output ΔT 50°C Watts/BTU's	Output ΔT 60°C BTU's	Price (ex VAT) Chrome	Price (inc VAT) Chrome	Stock or made to order
	H	W	D								
MD060	1200	500	93	3-3-3	464	300	834 / 2846	3597	655.00	786.00	✓
MD060	1200	600	93	3-3-3	564	400	1033 / 3525	4455	710.00	852.00	✓
MD060	1500	500	93	3-3-3-3	464	400	1145 / 3907	4938	764.00	916.80	✓
MD060	1500	600	93	3-3-3-3	564	400	1438 / 4906	6202	822.00	986.40	✓

Nexus III

Wall Mounted TM001

High heat output from a radiator combined with a stylish brass frame makes the perfect combination of heat, good looks and versatility to enhance any bathroom or utility room. Prices shown are for central heating models. The inset radiator comes in white as standard.



Please see pages 162 & 163 for finishes and colour options applicable to the tubular frame only. Please Note: The colour option does not apply to the inset radiator.



Nexus III

Tube diameter ∅ 25.4 + 15mm	Dimensions (mm)			Bar Config	Pipe Centres	Electric element wattage	Output ΔT 50°C Watts/BTU's	Output ΔT 60°C BTU's	Price (ex VAT) Chrome	Price (inc VAT) Chrome	Stock or made to order
	H	W	D								
TM001	900	525	142	6	500	400	716 / 2443	3088	1004.00	1204.80	👇

For electric element & valve options see pages 154 & 160



VL003

Resplendent in a durable plated PVD brushed brass finish, Concord is a statement piece to adorn any well dressed bathroom wall. Concord also has great functionality with good heat output and plenty of space to warm towels.

Concord

Wall Mounted DR041



NEW Product

Prices shown are for central heating models.

For electric element & valve options see pages 154 & 160



Concord

Tube diameter ∅ 12 + 24 x 38mm	Dimensions (mm)			Bar Config	Pipe Centres	Electric element wattage	Output ΔT 50°C Watts/BTU's	Output ΔT 60°C BTU's	Price (ex VAT) PVD Brushed Brass	Price (inc VAT) PVD Brushed Brass	Stock or made to order
	H	W	D								
DR041	1200	500	102	3-4-5	450	300	437 / 1491	1889	542.00	650.40	✓



VL004

Tempo

Wall Mounted MD072

A contemporary multirail, with protruding bars for extra towel hanging space. Prices shown are chromed finish for central heating models.



A towel warmer providing great efficiency and easy to install with its lightweight material. Available in white or anthracite.

Astute

Wall Mounted CN095



MS C D E

Tempo

Tube diameter Ø 22 + 30 x 40mm D section	Dimensions (mm)			Bar Config	Pipe Centres	Electric element wattage	Output ΔT 50°C Watts/BTU's	Output ΔT 60°C BTU's	Price (ex VAT) Chrome	Price (inc VAT) Chrome	Stock or made to order
	H	W	D								
MD072	800	500	170-190	17 + 9	455	150	416 / 1419	1794	281.00	337.20	✓
MD072	1160	500	170-190	25 + 12	455	300	592 / 2020	2553	382.00	458.40	✓

For electric element & valve options see pages 154 & 160



VL003

AL H D E

Astute

	Dimensions (mm)			Bar config	Pipe centres	Electric element wattage	Output ΔT 50°C Watts/BTU's	Output ΔT 60°C BTU's	Price White		Price Anthracite		Stock or made to order
	H	W	D						ex VAT,	inc VAT	ex VAT,	ex VAT,	
CN095	1200	500	100	10	470	600	778 / 2655	3355	399.00	478.80	410.00	492.00	✓
CN095	1600	500	100	13	470	600	1043 / 3560	4511	451.00	541.20	462.00	554.40	✓

For electric element & valve options see pages 154 & 160



VL003



Ladder Rails

Who said being practical had to be boring?

Our range of ladder rails combine function and form effortlessly. Choose from our inspired range and heating your room and warming your towels need never be dull again.

Focus MD001 in Satin Black
See page 75

Axis MD062

Our Axis has adjustable brackets through the crossbars, which offers freedom and ease of installation. The amount of rails are ideal for optimum efficiency. This contemporary rail is a modern example of proficient design. Prices shown are for chrome finish, central heating models.

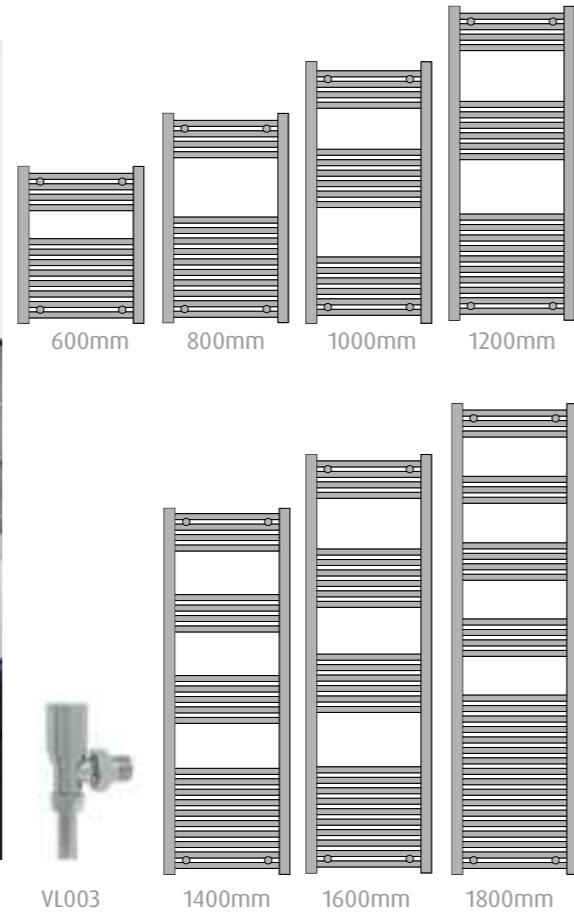

VL003 For electric element & valve options see pages 154 & 160

MS C D E

Axis

Tube diameter Ø 22 + 30 x 40mm D section	Dimensions (mm)			Bar Config	Pipe Centres	Electric element wattage	Output ΔT 50°C Watts/BTU's	Output ΔT 60°C BTU's	Price (ex VAT) Chrome	Price (inc VAT) Chrome	Stock or made to order
	H	W	D								
MD062	600	400	83 - 105	4-8	355	100	172 / 587	742	132.00	158.40	✓
MD062	600	500	83 - 105	4-8	455	125	208 / 710	897	138.00	165.60	✓
MD062	600	600	83 - 105	4-8	555	125	245 / 836	1057	144.00	172.80	✓
MD062	800	300	83 - 105	4-10	255	100	167 / 570	720	151.00	181.20	✓
MD062	800	400	83 - 105	4-10	355	100	209 / 713	901	156.00	187.20	✓
MD062	800	500	83 - 105	4-10	455	125	252 / 860	1087	166.00	199.20	✓
MD062	800	600	83 - 105	4-10	555	150	295 / 1007	1272	177.00	212.40	✓
MD062	800	750	83 - 105	4-10	705	200	359 / 1225	1548	196.00	235.20	✓
MD062	1000	300	83 - 105	4-6-6	255	150	204 / 696	880	162.00	194.40	✓
MD062	1000	400	83 - 105	4-6-6	355	150	256 / 873	1104	172.00	206.40	✓
MD062	1000	500	83 - 105	4-6-6	455	200	308 / 1051	1328	187.00	224.40	✓
MD062	1000	600	83 - 105	4-6-6	555	200	361 / 1232	1557	199.00	238.80	✓
MD062	1200	300	83 - 105	4-6-10	255	200	250 / 853	1078	184.00	220.80	✓
MD062	1200	400	83 - 105	4-6-10	355	200	313 / 1068	1350	190.00	228.00	✓
MD062	1200	500	83 - 105	4-6-10	455	200	378 / 1290	1630	201.00	241.20	✓
MD062	1200	600	83 - 105	4-6-10	555	300	443 / 1512	1911	221.00	265.20	✓
MD062	1200	750	83 - 105	4-6-10	705	300	537 / 1832	2316	231.00	277.20	✓
MD062	1400	500	83 - 105	4-4-5-10	455	300	431 / 1471	1859	224.00	268.80	✓
MD062	1400	600	83 - 105	4-4-5-10	555	300	504 / 1720	2174	244.00	292.80	✓
MD062	1600	400	83 - 105	4-6-6-10	355	300	412 / 1406	1777	246.00	295.20	✓
MD062	1600	500	83 - 105	4-6-6-10	455	300	495 / 1689	2135	248.00	297.60	✓
MD062	1600	600	83 - 105	4-6-6-10	555	400	580 / 1979	2501	264.00	316.80	✓
MD062	1800	400	83 - 105	3-3-4-4-17	355	400	464 / 1583	2001	294.00	352.80	✓
MD062	1800	500	83 - 105	3-3-4-4-17	455	400	558 / 1904	2407	311.00	373.20	✓
MD062	1800	600	83 - 105	3-3-4-4-17	555	400	654 / 2231	2821	333.00	399.60	✓
MD062	1800	750	83 - 105	3-3-4-4-17	705	400	815 / 2781	3515	338.00	405.60	✓

Straight Bars



Optional Blanking Plug with Aroma Oil Dish

AC035

£12.00 ex VAT £14.40 inc VAT



Image showing Matt Black finish



MS C D E

Axis Matt Black

For electric element & valve options see pages 154 & 160

	Dimensions (mm)			Bar Config	Pipe Centres	Electric element wattage	Output ΔT 50°C Watts/BTU's	Output ΔT 60°C BTU's	Price (ex VAT) Matt Black	Price (inc VAT) Matt Black	Stock or made to order
	H	W	D								
MD062	800	500	83 - 105	4-5-5	455	125	328 / 1119	1414	111.00	133.20	✓
MD062	800	600	83 - 105	4-5-5	555	150	384 / 1310	1656	122.00	146.40	✓
MD062	1200	500	83 - 105	4-5-12	455	200	492 / 1678	2121	133.00	159.60	✓
MD062	1200	600	83 - 105	4-5-12	555	300	576 / 1965	2484	145.00	174.00	✓
MD062	1600	500	83 - 105	4-5-5-9	455	300	644 / 2197	2777	157.00	188.40	✓
MD062	1600	600	83 - 105	4-5-5-9	555	400	754 / 2572	3251	168.00	201.60	✓



VL003 Matt Black

Combes

22mm Wall Mounted MD063

Our Combes offers adjustable brackets through the crossbars also offer freedom and ease of installation. Offering a copious amount of rails for optimum efficiency, this contemporary rail is a modern example of proficient design. The curved version of our MD062. Prices shown are for chromed finish, central heating models.



Optional Aroma Plug

Blanking Plug with Aroma Oil Dish

AC035

£12.00 ex VAT,

£14.40 inc VAT

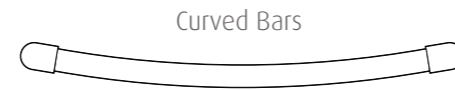

Curved Bars

For electric element & valve options see pages 154 & 160



VL003

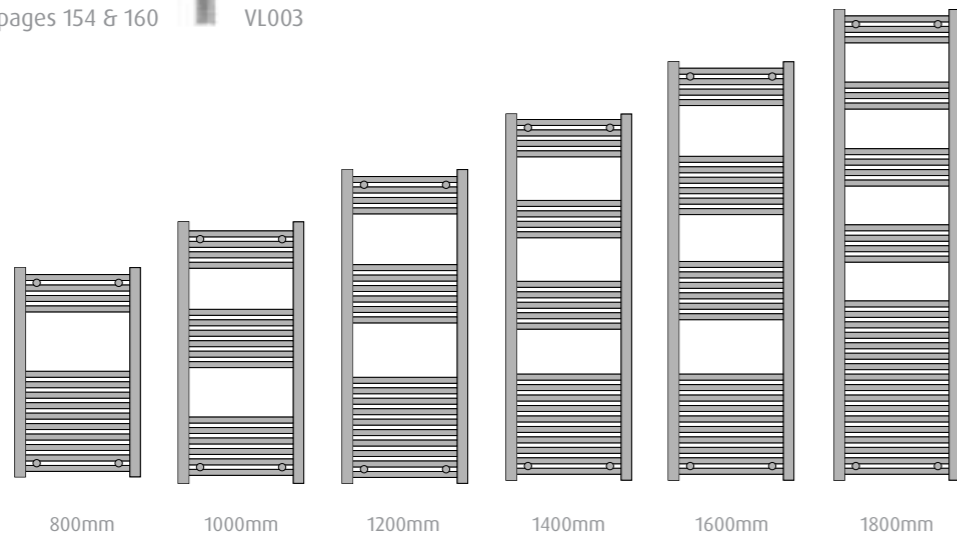

800mm

1000mm

1200mm

1400mm

1600mm

1800mm



Combes (Curved)

Tube diameter Ø 22 + 30 x 40mm D section	Dimensions (mm)			Bar Config	Pipe Centres	Electric element wattage	Output ΔT 50°C Watts/BTU's	Output ΔT 60°C BTU's	Price (ex VAT) Chrome	Price (inc VAT) Chrome	Stock or made to order
	H	W	D								
MD063	800	500	89 - 119	4-10	455	125	252 / 860	1087	171.00	205.20	✓
MD063	800	600	95 - 125	4-10	555	150	295 / 1007	1272	184.00	220.80	✓
MD063	1000	500	89 - 119	4-6-6	455	200	308 / 1051	1328	190.00	228.00	✓
MD063	1000	600	95 - 125	4-6-6	555	200	361 / 1232	1557	204.00	244.80	✓
MD063	1200	500	89 - 119	4-6-10	455	200	378 / 1290	1630	208.00	249.60	✓
MD063	1200	600	95 - 125	4-6-10	555	300	443 / 1512	1911	228.00	273.60	✓
MD063	1400	500	89 - 119	4-4-5-10	455	300	431 / 1471	1859	229.00	274.80	✓
MD063	1400	600	95 - 125	4-4-5-10	555	300	504 / 1720	2174	247.00	296.40	✓
MD063	1600	500	89 - 119	4-6-6-10	455	300	495 / 1689	2135	256.00	307.20	✓
MD063	1600	600	95 - 125	4-6-6-10	555	400	580 / 1979	2501	270.00	324.00	✓
MD063	1800	500	89 - 119	3-3-4-4-17	455	400	558 / 1904	2407	317.00	380.40	✓
MD063	1800	600	95 - 125	3-3-4-4-17	555	400	654 / 2231	2821	340.00	408.00	✓



Mild Steel Metallic Finish Supplements

Gold - POA

Bright Nickel -

Chrome £221.00 ex VAT, £265.20 inc VAT

Brushed Nickel -

Chrome £309.00 ex VAT, £370.80 inc VAT

Focus

25mm Wall Mounted MD001

Focus is a range of 25mm tube design towel warmers with high heat output and superior looks. Manufactured from high quality mild steel with smooth flat tops and rear air vent. Prices are for chrome and white central heating models. Prices are for chrome and white central heating models.



Image shown with VL015 valves

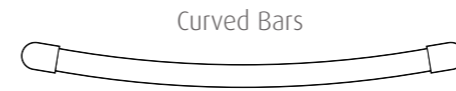

Mild Steel Metallic Finish Supplements

- Gold - POA
- Bright Nickel -
Chrome £221.00 ex VAT, £265.20 inc VAT
- Brushed Nickel -
Chrome £309.00 ex VAT, £370.80 inc VAT



For electric element & valve options see pages 154 & 160

The curved version of the Focus. The Chorus has all the same attributes with high heat output and superb looks. Prices shown are for chrome or white central heating models. Please see page 162 for colour options.

Chorus

25mm Wall Mounted MD002



Image shown with VL015 valves

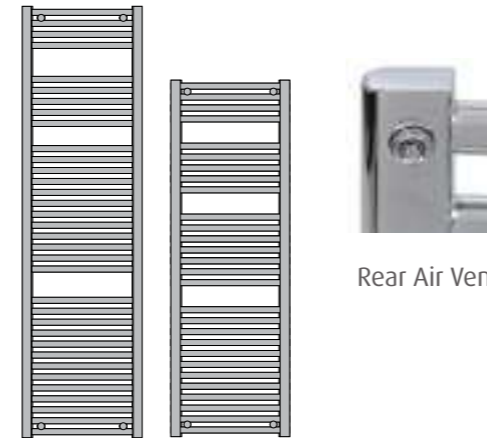

1800mm 34 cross bars
1500mm 28 cross bars

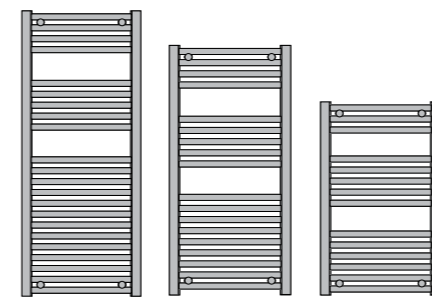

1200mm 22 cross bars
1000mm 18 cross bars
800mm 14 cross bars



Available in other contemporary colours

Focus (Straight)

Tube diameter 25 + 30 x 40mm D section	Dimensions (mm)			Bar Config	Pipe Centres	Electric element wattage	Output ΔT 50°C Watts/BTU's		Output ΔT 60°C BTU's		Price Chrome		Price White		Stock or made to order
	H	W	D				chrome	white	chrome	white	ex VAT,	inc VAT	ex VAT,	inc VAT	
MD001	800	300	93-113	3-5-6	255	100	177 / 604	271 / 925	763	1169	191.00	229.20	103.00	123.60	✓
MD001	800	400	93-113	3-5-6	355	125	226 / 771	346 / 1181	975	1492	196.00	235.20	109.00	130.80	✓
MD001	800	500	93-113	3-5-6	455	150	275 / 938	420 / 1433	1186	1811	216.00	259.20	122.00	146.40	✓
MD001	800	600	93-113	3-5-6	555	200	324 / 1105	495 / 1689	1397	2135	238.00	285.60	128.00	153.60	✓
MD001	1000	500	93-113	4-5-9	455	200	351 / 1198	446 / 1522	1514	1923	250.00	300.00	132.00	158.40	✓
MD001	1000	600	93-113	4-5-9	555	200	414 / 1413	510 / 1740	1785	2200	258.00	309.60	134.00	160.80	✓
MD001	1200	300	93-113	4-5-13	255	200	273 / 931	424 / 1447	1177	1829	270.00	324.00	136.00	163.20	✓
MD001	1200	400	93-113	4-5-13	355	200	350 / 1194	543 / 1853	1509	2342	276.00	331.20	147.00	176.40	✓
MD001	1200	500	93-113	4-5-13	455	300	428 / 1460	663 / 2262	1846	2859	301.00	361.20	164.00	196.80	✓
MD001	1200	600	93-113	4-5-13	555	400	505 / 1723	783 / 2672	2178	3377	333.00	399.60	177.00	212.40	✓
MD001	1500	500	93-113	4-5-7-12	455	300	534 / 1822	820 / 2798	2303	3536	379.00	454.80	189.00	226.80	✓
MD001	1500	600	93-113	4-5-7-12	555	400	631 / 2153	969 / 3306	2721	4192	424.00	508.80	196.00	235.20	✓
MD001	1800	400	93-113	4-5-12-13	355	400	521 / 1778	793 / 2706	2247	3420	433.00	519.60	210.00	252.00	✓
MD001	1800	500	93-113	4-5-12-13	455	600	638 / 2177	969 / 3306	2752	4179	467.00	560.40	219.00	262.80	✓
MD001	1800	600	93-113	4-5-12-13	555	600	754 / 2573	1146 / 3910	3252	4942	522.00	626.40	247.00	296.40	✓



Chorus (Curved)

Tube diameter 25 + 30 x 40mm D section	Dimensions (mm)			Bar Config	Pipe Centres	Electric element wattage	Output ΔT 50°C Watts/BTU's		Output ΔT 60°C BTU's		Price Chrome		Price White		Stock or made to order
	H	W	D				chrome	white	chrome	white	ex VAT,	inc VAT	ex VAT,	inc VAT	
MD002	800	500	88-108	3-5-6	455	150	275 / 938	420 / 1433	1186	1811	221.00	265.20	128.00	153.60	✓
MD002	800	600	94-114	3-5-6	555	200	324 / 1105	495 / 1689	1397	2135	251.00	301.20	136.00	163.20	✓
MD002	1000	500	88-108	4-5-9	455	200	351 / 1198	-	1514	-	270.00	324.00	-	-	✓
MD002	1000	600	94-114	4-5-9	555	200	414 / 1413	-	1785	-	276.00	331.20	-	-	✓
MD002	1200	500	88-108	4-5-13	455	300	428 / 1460	663 / 2262	1846	2859	320.00	384.00	174.00	208.80	✓
MD002	1200	600	94-114	4-5-13	555	400	505 / 1723	783 / 2672	2178	3377	348.00	417.60	187.00	224.40	✓
MD002	1500	500	88-108	4-5-7-12	455	300	534 / 1822	820 / 2798	2303	3536	440.00	528.00	206.00	247.20	✓
MD002	1500	600	94-114	4-5-7-12	555	400	631 / 2153	969 / 3306	2721	4179	495.00	594.00	216.00	259.20	✓
MD002	1800	500	88-108	4-5-12-13	455	600	638 / 2177	969 / 3306	2752	4179	496.00	595.20	238.00	285.60	✓
MD002	1800	600	94-114	4-5-12-13	555	600	754 / 2573	1146 / 3910	3252	4942	551.00	661.20	256.00	307.20	✓

For electric element & valve options see pages 154 & 160



Focus Horizontal

25mm Wall Mounted MD001H

Our Focus horizontal is a smart alternative to the typical ladder-rail style. Allowing you to hang towels side by side and a perfect fit for underneath a window or shelf, with high heat output and superb looks.



Prices shown are for chrome, White or Anthracite central heating models. Please see page 162 for colour options.

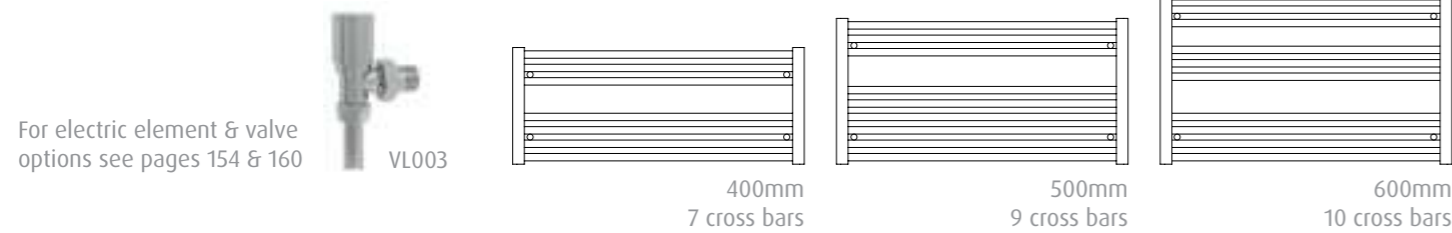

Focus Horizontal

Please note painted models supplied with chrome brackets

Tube diameter 25 + 30 x 40mm D section	Dimensions (mm)			Bar Config	Pipe Centres	Electric element wattage	Output ΔT 50°C Watts/BTU's		Output ΔT 60°C BTU's		Price Chrome		Price Anthracite or White		Stock or made to order
	H	W	D				Chrome	White or Anthracite	Chrome	White or Anthracite	ex VAT	inc VAT	ex VAT	inc VAT	
MD001H	400	1000	93-113	3-4	955	100	200 / 682	302 / 1030	863	1302	149.00	178.80	106.00	127.20	✓
MD001H	500	1000	93-113	3-6	955	125	256 / 873	386 / 1317	1104	1665	171.00	205.20	123.00	147.60	✓
MD001H	600	1000	93-113	3-3-4	955	150	288 / 983	434 / 1481	1242	1872	182.00	218.40	138.00	165.60	✓

Contemporary painted finishes in our popular 25mm horizontal tube multi-rail. Prices shown are for central heating models. Optional accessories available in different finishes. Steel Blue and Moss Green options available from January 2023.

Focus Colours

25mm Wall Mounted MD001



For electric element & valve options see pages 154 & 160



Focus Colours

*Mocha Textured and Latte Textured are priced separately to the other colour choices.

Tube diameter 25 + 30 x 40mm D section	Dimensions (mm)			Bar Config	Pipe Centres	Electric element wattage	Output ΔT 50°C Watts/BTU's	Output ΔT 60°C BTU's	Price (ex VAT) * Mocha/Latte	Price (inc VAT) * Mocha/Latte	Price (ex VAT) Colours	Price (inc VAT) Colours	Stock or made to order
	H	W	D										
MD001	800	400	93	3-5-6	355	125	346 / 1181	1493	183.00	219.60	130.00	156.00	✓
MD001	800	500	93	3-5-6	455	150	420 / 1433	1811	219.00	262.80	156.00	187.20	✓
MD001	1200	300	93	4-5-13	255	200	424 / 1447	1829	244.00	292.80	173.00	207.60	✓
MD001	1200	500	93	4-5-13	455	300	663 / 2262	2859	295.00	354.00	209.00	250.80	✓
MD001	1200	600	93	4-5-13	555	400	783 / 2672	3377	318.00	381.60	226.00	271.20	✓
MD001	1500	500	93	4-5-7-12	455	300	820 / 2798	3537	355.00	426.00	252.00	302.40	✓
MD001	1800	500	93	4-5-12-13	455	600	969 / 3306	4179	394.00	472.80	280.00	336.00	✓

Chube

Stainless Steel MD035

The round tube polished stainless steel design with rear air vent, brings together aesthetics and practicality. It will suit any modern bathroom. Please see page 162 for colour options. Stainless Steel suitable for all hot water systems.

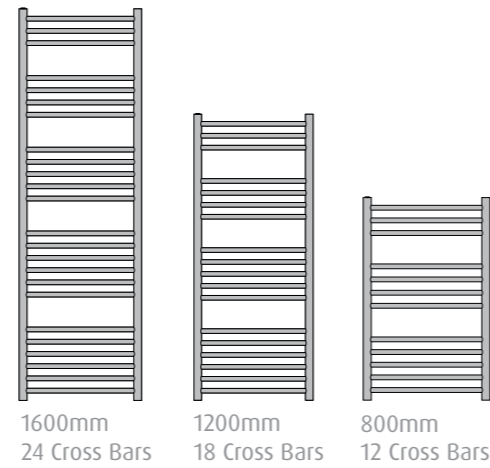

For electric element & valve options see pages 154 & 160



Chube

Tube diameter Ø 31.8 + 22mm	Dimensions (mm)			Bar Config	Pipe Centres	Electric element wattage	Output ΔT 50°C Watts/BTU's	Output ΔT 60°C BTU's	Price (ex VAT) Polished	Price (inc VAT) Polished	Stock or made to order
	H	W	D								
MD035	800	300	100	3-4-5	268	100	161 / 549	694	330.00	396.00	✓
MD035	800	400	100	3-4-5	368	100	197 / 672	850	362.00	434.40	✓
MD035	800	500	100	3-4-5	468	125	243 / 829	1048	394.00	472.80	✓
MD035	800	600	100	3-4-5	568	150	269 / 918	1160	455.00	546.00	✓
MD035	1200	300	100	3-4-5-6	268	125	240 / 819	1035	488.00	585.60	✓
MD035	1200	400	100	3-4-5-6	368	150	294 / 1003	1268	524.00	628.80	✓
MD035	1200	500	100	3-4-5-6	468	200	348 / 1187	1501	567.00	680.40	✓
MD035	1200	600	100	3-4-5-6	568	200	402 / 1372	1734	662.00	794.40	✓
MD035	1600	300	100	3-4-5-6-6	268	200	321 / 1095	1384	711.00	853.20	✓
MD035	1600	400	100	3-4-5-6-6	368	200	391 / 1334	1686	800.00	960.00	✓
MD035	1600	500	100	3-4-5-6-6	468	300	464 / 1583	2001	873.00	1047.60	✓
MD035	1600	600	100	3-4-5-6-6	568	300	536 / 1829	2312	961.00	1153.20	✓

Kerve is the curvaceous sibling of the Chube. As the name suggests the hanging bars have a gentle tactile bow. The design has an integral rear air vent for aesthetic appeal and ease of installation. Available in a wide range of heights and widths.

Kerve

Stainless Steel MD036

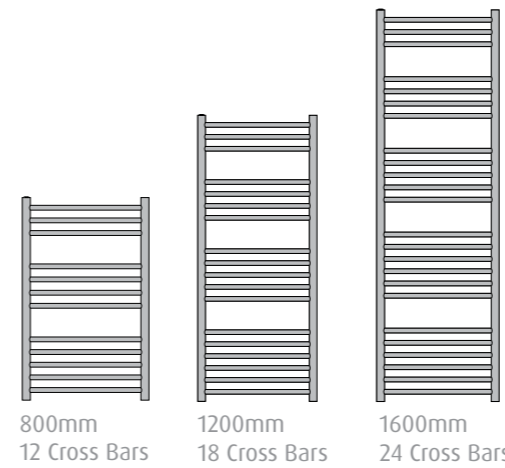
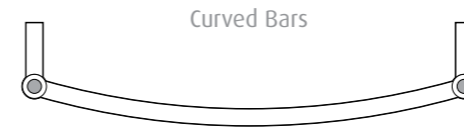

Polished stainless steel manufacture, suitable for all hot water systems. Please see page 162 for colour options.



Kerve

Tube diameter Ø 31.8 + 22mm	Dimensions (mm)			Bar Config	Pipe Centres	Electric element wattage	Output ΔT 50°C Watts/BTU's	Output ΔT 60°C BTU's	Price (ex VAT) Polished	Price (inc VAT) Polished	Stock or made to order
	H	W	D								
MD036	800	500	120	3-4-5	468	125	243 / 829	1048	457.00	548.40	✓
MD036	800	600	130	3-4-5	568	150	269 / 918	1160	520.00	624.00	✓
MD036	1200	500	120	3-4-5-6	468	200	348 / 1187	1501	640.00	768.00	✓
MD036	1200	600	130	3-4-5-6	568	200	402 / 1372	1734	735.00	882.00	✓
MD036	1600	500	120	3-4-5-6-6	468	300	464 / 1583	2001	891.00	1069.20	✓
MD036	1600	600	130	3-4-5-6-6	568	300	536 / 1829	2312	977.00	1172.40	✓

For electric element & valve options see pages 154 & 160



Galaxy

Stainless Steel MD059

Galaxy has clean lines and plenty of hanging space. Manufactured from polished stainless steel. Please see page 162 for colour options. Suitable for all hot water systems.

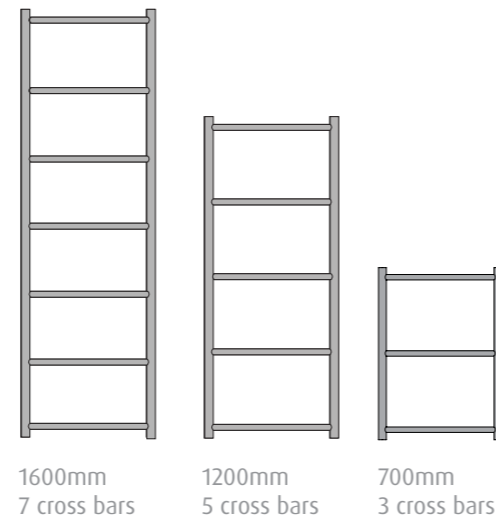

For electric element & valve options see pages 154 & 160



Galaxy

Tube diameter	Dimensions (mm)			Bar Config	Pipe Centres	Electric element wattage	Output ΔT 50°C Watts/BTU's	Output ΔT 60°C BTU's	Price (ex VAT) Polished	Price (inc VAT) Polished	Stock or made to order
	H	W	D								
31.8 + 22mm											
MD059	700	500	100	3	468	75	86 / 293	371	354.00	424.80	✓
MD059	1200	500	100	5	468	100	217 / 740	936	548.00	657.60	✓
MD059	1600	500	100	7	468	125	296 / 1010	1277	704.00	844.80	✓

High quality polished stainless steel. Pearl's chic styling and sensible design allows you to hang towels side by side. Suitable for all hot water systems. Please see page 162 for colour options.

Pearl

Stainless Steel MD058

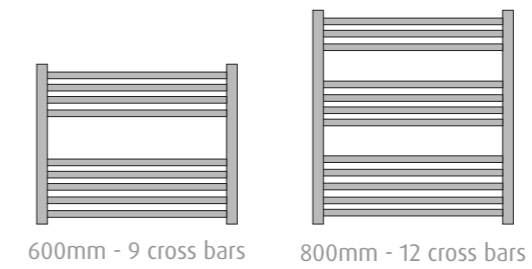

For electric element & valve options see pages 154 & 160



Pearl

Tube diameter	Dimensions (mm)			Bar Config	Pipe Centres	Electric element wattage	Output ΔT 50°C Watts/BTU's	Output ΔT 60°C BTU's	Price (ex VAT) Polished	Price (inc VAT) Polished	Stock or made to order
	H	W	D								
31.8 + 22mm											
MD058	600	750	100	4-5	718	100	419 / 1430	1807	498.00	597.60	✓
MD058	600	1000	100	4-5	968	125	517 / 1764	2230	574.00	688.80	✓
MD058	800	750	100	3-4-5	718	125	529 / 1805	2281	605.00	726.00	✓
MD058	800	1000	100	3-4-5	968	150	682 / 2327	2941	662.00	794.40	✓

Tune

Wall Mounted MD003

Tune has straight cross rails and the Melody has a gentle curve. Both are exceptionally practical and work well in bathrooms and kitchens alike. Prices shown are chrome finished for central heating models.



Optional Aroma Plug
Blanking Plug with Aroma
Oil Dish AC035
£12.00 ex VAT, £14.40 inc VAT

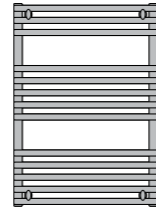

772mm
13 Cross Bars

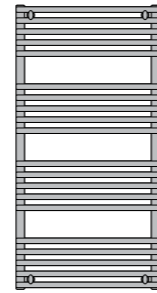

1186mm
20 Cross Bars

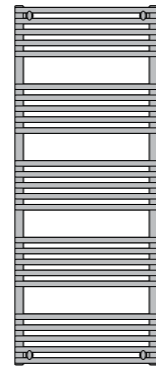

1508mm
25 Cross Bars

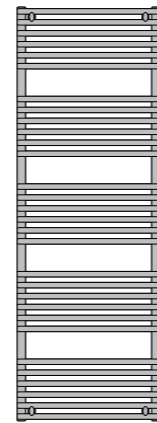

1738mm
30 Cross Bars

For electric element & valve options see pages 154 & 160  VL003

MS C D E

Tune (Straight)

Tube diameter Ø 32 + 22mm	Dimensions (mm)			Bar Config	Pipe Centres	Electric element wattage	Output ΔT 50°C Watts/BTU's	Output ΔT 60°C BTU's	Price (ex VAT) Chrome	Price (inc VAT) Chrome	Stock or made to order
	H	W	D								
MD003	772	500	80 - 95	3-5-5	450	125	290 / 989	1251	237.00	284.40	✓
MD003	772	600	80 - 95	3-5-5	550	200	347 / 1184	1497	251.00	301.20	✓
MD003	1186	500	80 - 95	5-5-5-5	450	300	465 / 1587	2005	321.00	385.20	✓
MD003	1186	600	80 - 95	5-5-5-5	550	300	553 / 1887	2385	349.00	418.80	✓
MD003	1508	500	80 - 95	5-5-5-5-5	450	400	581 / 1982	2506	385.00	462.00	✓
MD003	1508	600	80 - 95	5-5-5-5-5	550	400	686 / 2341	2959	418.00	501.60	✓
MD003	1738	500	80 - 95	6-6-6-6-6	450	600	687 / 2344	2963	443.00	531.60	✓
MD003	1738	600	80 - 95	6-6-6-6-6	550	600	815 / 2781	3515	480.00	576.00	✓

Melody

Wall Mounted MD004

Our curved model of Tune - MD003, the MD004's tube on tube details produce a clean, modern and smooth look. Using the iconic form of the multirail alongside the extra detailed touches creates an alternative look for any setting.



MS C D E

Melody (Curved)

Tube diameter Ø 32 + 22mm	Dimensions (mm)			Bar Config	Pipe Centres	Electric element wattage	Output ΔT 50°C Watts/BTU's	Output ΔT 60°C BTU's	Price (ex VAT) Chrome	Price (inc VAT) Chrome	Stock or made to order
	H	W	D								
MD004	772	500	100 - 115	3-5-5	450	125	290 / 989	1251	241.00	289.20	✓
MD004	772	600	100 - 115	3-5-5	550	200	347 / 1184	1497	259.00	310.80	✓
MD004	1186	500	100 - 115	5-5-5-5	450	300	465 / 1587	2005	325.00	390.00	✓
MD004	1186	600	100 - 115	5-5-5-5	550	300	553 / 1887	2385	380.00	456.00	✓
MD004	1508	500	100 - 115	5-5-5-5-5	450	400	581 / 1982	2506	394.00	472.80	✓
MD004	1508	600	100 - 115	5-5-5-5-5	550	400	686 / 2341	2959	428.00	513.60	✓
MD004	1738	500	100 - 115	6-6-6-6-6	450	600	687 / 2344	2959	449.00	538.80	✓
MD004	1738	600	100 - 115	6-6-6-6-6	550	600	815 / 2781	3515	489.00	586.80	✓

For electric element & valve options see pages 154 & 160  VL003

Stella

Stainless Steel MD034

Contemporary styling always makes an impact. Stella is manufactured from polished stainless steel. Suitable for all hot water systems.

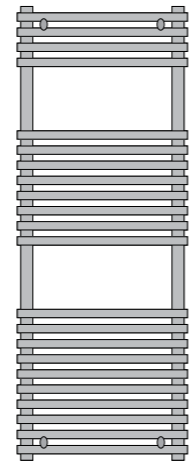

1200mm
22 cross bars

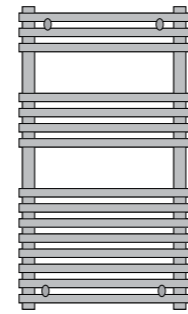

800mm
15 cross bars

VL003
For electric element & valve options see pages 154 & 160



Studio

Wall Mounted MD006

Simple style, with bold straight cross rails and discreet fixed brackets. Manufactured from a high quality brass. Supplied with a hidden rear air vent for aesthetic appeal and ease of installation. Available in three different heights.

The Studio model comes in a unlacquered brushed brass finish as standard. An extra process for a lacquered finish can be provided for that premium look with a supplement charge of 20% on the price of chrome.

If you need a different size, talk to us about our bespoke service. Prices shown are for all hot water and heating systems.

Please see pages 162 & 163 for finishes and colour options.



Rear air vent
Capped off smooth ends for aesthetic appeal and ease of installation.

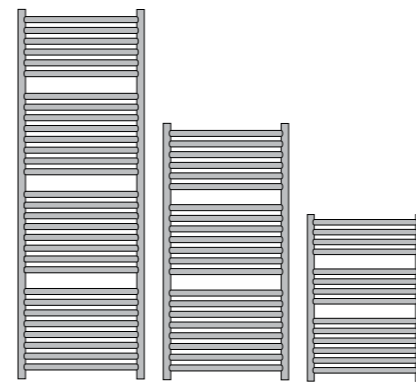

1435mm 30 Cross Bars
1000mm 21 Cross Bars
720mm 14 Cross Bars



Image showing Brushed Brass finish, same price as Chrome.

SS H D E

Stella

Tube diameter Ø 22 + 30mm	Dimensions (mm)			Bar Config	Pipe Centres	Electric element wattage	Output ΔT 50°C Watts/BTU's	Output ΔT 60°C BTU's	Price (ex VAT) Polished	Price (inc VAT) Polished	Stock or made to order
	H	W	D								
MD034	800	450	75 - 95	3-4-8	400	125	412 / 1406	1777	483.00	579.60	✓
MD034	800	600	75 - 95	3-4-8	550	200	515 / 1757	2221	514.00	616.80	✓
MD034	1200	450	75 - 95	4-8-10	400	200	608 / 2074	2622	664.00	796.80	✓
MD034	1200	600	75 - 95	4-8-10	550	300	759 / 2590	3273	793.00	951.60	✓

BR H D E

Studio

Tube diameter Ø 31.8 + 25.4mm	Dimensions (mm)			Bar Config	Pipe Centres	Electric element wattage	Output ΔT 50°C Watts/BTU's	Output ΔT 60°C BTU's	Price (ex VAT) Chrome or Brushed Brass	Price (inc VAT) Chrome or Brushed Brass	Stock or made to order
	H	W	D								
MD006	720	500	90	4-4-6	468	125	327 / 1116	1410	938.00	1125.60	✓
MD006	1000	500	90	6-7-8	468	200	482 / 1645	2079	1296.00	1555.20	✓
MD006	1435	500	90	6-8-8-8	468	300	690 / 2354	2976	1767.00	2120.40	✓

For electric element & valve options see pages 154 & 160



VL003



Traditional

Go timeless and give your room a focal point that never fails to impress. Our range of classic designs, in a stunning choice of colours and finishes, add instant elegance to your room, each is handcrafted to stand the test of time.

Regency

Floor and Wall Mounted LG004-MS

The classic column radiator towel rail, offering high heat output. Mild steel manufactured framework with an integral white mild steel column radiator. Colour option only applies to the inset radiator, not the frame.

Mild Steel Metallic Finish Supplements

Gold - POA

Bright Nickel - Chrome £221.00 ex VAT, £265.20 inc VAT

Brushed Nickel - Chrome £309.00 ex VAT, £370.80 inc VAT



Chrome frame with Bronze crackle radiator

Chrome frame with standard white radiator

Prices shown are chrome finished with a white integral radiator, central heating models.



Regency MS

Tube diameter Ø 31.8mm	Dimensions (mm)			Sections	Face to Face connections	Electric element wattage	Output ΔT 50°C Watts/BTU's	Output ΔT 60°C BTU's	Price (ex VAT) Chrome	Price (inc VAT) Chrome	Stock or made to order
	H	W	D								
LG004-MS	963	538	230	5	393	200	392 / 1338	1691	566.00	679.20	✓
LG004-MS	963	673	230	8	528	300	554 / 1890	2389	671.00	805.20	✓
LG004-MS	963	763	230	10	618	400	653 / 2228	2816	766.00	919.20	✓

For electric element & valve options see pages 154 & 160



VL008

An authentic column radiator towel rail, offering high heat output. Brass manufactured framework with an integral white mild steel column radiator.

Regency

Floor and Wall Mounted LG004-BR / OG006-BR



LG Ball Joint



OG Ball Joint

Prices shown are chrome finished for central heating models. Please see pages 162 & 163 for finishes and colour options.



Regency BR

Tube diameter Ø 31.8mm	Dimensions (mm)			Sections	Face to Face connections	Electric element wattage	Output ΔT 50°C Watts/BTU's	Output ΔT 60°C BTU's	Price (ex VAT) Chrome	Price (inc VAT) Chrome	Stock or made to order
	H	W	D								
LG004C-BR	938	500	250	5	343	200	392 / 1338	1691	1271.00	1525.20	✘
LG004B-BR	938	675	250	8	518	400	554 / 1890	2389	1284.00	1540.80	✘
LG004A-BR	938	735	250	10	578	400	653 / 2228	2816	1293.00	1551.60	✘
OG006C-BR	938	500	250	5	343	200	392 / 1338	1691	1300.00	1560.00	✘
OG006B-BR	938	675	250	8	518	400	554 / 1890	2389	1310.00	1572.00	✘
OG006A-BR	938	735	250	10	578	400	653 / 2228	2816	1323.00	1587.60	✘

For electric element & valve options see pages 154 & 160



VL008

Regency

Wall Mounted LG005 / OG015

A classic design with a compact height. This towel rail looks great alongside the bath, at the right height for reaching your luxuriously warm towel. Brass or Mild Steel manufactured framework with an integral white mild steel column radiator.

Mild Steel Metallic Finish Supplements

Gold - POA

Bright Nickel - Chrome £221.00 ex VAT, £265.20 inc VAT

Brushed Nickel - Chrome £309.00 ex VAT, £370.80 inc VAT



Image showing Brushed Brass frame and Satin Black radiator



LG Ball Joint



OG Ball Joint

Other colours can be specified. Please see pages 162 & 163 for finishes and colour options. The colour option does not apply to the Mild Steel (MS) model inset radiators. Prices shown are chrome finished for central heating models.

MS **C** **D** **E**

Regency - MS

Tube diameter Ø 31.8mm	Dimensions (mm)			Sections	Pipe Centres	Electric element wattage	Output ΔT 50°C Watts/BTU's	Output ΔT 60°C BTU's	Price (ex VAT) Chrome	Price (inc VAT) Chrome	Stock or made to order
	H	W	D								
LG005-MS	740	675	250	8	600	300	568 / 1938	2450	666.00	799.20	✓

For electric element & valve options see pages 154 & 160



VL008

BR **C** **D** **E**

Regency - BR

Tube diameter Ø 31.8mm	Dimensions (mm)			Sections	Pipe Centres	Electric element wattage	Output ΔT 50°C Watts/BTU's	Output ΔT 60°C BTU's	Price (ex VAT) Chrome	Price (inc VAT) Chrome	Stock or made to order
	H	W	D								
LG005C-BR	740	500	250	5	425	200	384 / 1310	1656	1330.00	1596.00	🚫
LG005B-BR	740	675	250	8	600	400	541 / 1846	2333	1420.00	1704.00	🚫
LG005A-BR	740	735	250	10	660	400	643 / 2194	2773	1481.00	1777.20	🚫
OG015-BR	740	500	250	5	425	200	384 / 1310	1656	1361.00	1633.20	🚫
OG015-BR	740	675	250	8	600	400	541 / 1846	2333	1443.00	1731.60	🚫
OG015-BR	740	735	250	10	660	400	643 / 2194	2773	1463.00	1755.60	🚫

Regency II

Wall Mounted LG036 / OG009

The Regency II Wall Mounted emanates traditional style. This handmade British design will stand the test of time. A Vogue UK design, liked for its heat output, hanging space and unique design.



LG Ball Joint



OG Ball Joint

Brass manufactured framework with an integral white mild steel column radiator. Your choice of Legacy or Originals ball joint. Other radiator colours can be specified on ordering. Prices shown are chrome finished for central heating models. Please see pages 162 & 163 for finishes and colour options.

BR **C** **D** **E**

Regency II

Tube diameter Ø 31.8mm	Dimensions (mm)			Sections	Pipe Centres	Electric element wattage	Output ΔT 50°C Watts/BTU's	Output ΔT 60°C BTU's	Price (ex VAT) Chrome	Price (inc VAT) Chrome	Stock or made to order
	H	W	D								
LG036-BR	825	500	150	5	425	200	384 / 1310	1656	1328.00	1593.60	🚫
LG036-BR	825	675	150	8	600	400	570 / 1945	2458	1419.00	1702.80	🚫
LG036-BR	825	735	150	10	660	400	671 / 2289	2894	1480.00	1776.00	🚫
OG009C-BR	825	500	160	5	425	200	384 / 1310	1656	1410.00	1692.00	🚫
OG009B-BR	825	675	160	8	600	400	570 / 1945	2458	1493.00	1791.60	🚫
OG009A-BR	825	735	160	10	660	400	671 / 2289	2894	1546.00	1855.20	🚫

For electric element & valve options see pages 154 & 160



VL008

Regency Tall

Floor and Wall Mounted LG013-MS

Ideal for family bathrooms or a special en-suite. Mild steel manufactured framework with an integral white mild steel column radiator. Prices shown are chrome finished for central heating models.

Brass manufactured with an integral white mild steel column radiator, Regency Tall provides the luxury of a superior finish.

Regency Tall

Floor and Wall Mounted LG013-BR / OG007-BR



LG013FW-MS

Mild Steel Metallic Finish Supplements

Gold - POA

Bright Nickel - Chrome £221.00 ex VAT, £265.20 inc VAT

Brushed Nickel - Chrome £309.00 ex VAT, £370.80 inc VAT



For electric element & valve options see pages 154 & 160

VL008



Available in optional metallic and colour finishes. Please see pages 162 & 163 for finishes and colour options. Prices shown are chrome finished for central heating models. Element position advised at point of ordering.



For electric element & valve options see pages 154 & 160

VL008

MS C D E

Regency Tall WM MS

Tube diameter Ø 31.8mm	Dimensions (mm)			Sections	Pipe Centres	Electric element wattage	Output ΔT 50°C Watts/BTU's	Output ΔT 60°C BTU's	Price (ex VAT) Chrome	Price (inc VAT) Chrome	Stock or made to order
	H	W	D								
LG013WM-MS	1403	575	250	5	500	400	824 / 2811	3554	808.00	969.60	✓

Regency Tall FW MS

Tube diameter Ø 31.8mm	Dimensions (mm)			Sections	Face to Face connections	Electric element wattage	Output ΔT 50°C Watts/BTU's	Output ΔT 60°C BTU's	Price (ex VAT) Chrome	Price (inc VAT) Chrome	Stock or made to order
	H	W	D								
LG013FW-MS	1500	500	250	5	355	400	815 / 2781	3515	898.00	1077.60	✓

BR C D E

Regency Tall BR

Tube diameter Ø 31.8mm	Dimensions (mm)			Sections	Face to Face connections	Electric element wattage	Output ΔT 50°C Watts/BTU's	Output ΔT 60°C BTU's	Price (ex VAT) Chrome	Price (inc VAT) Chrome	Stock or made to order
	H	W	D								
LG013FW-BR	1500	500	250	5	343	400	738 / 2518	3183	1548.00	1857.60	✘
OG007FW-BR	1500	500	250	5	343	400	738 / 2518	3183	1753.00	2103.60	✘

Arcadia

Floor Mounted LG017 / OG017

Arcadia, the classic war horse. A very British design which has stood the test of time. In brass or mild steel manufactured models, with plenty of towel hanging space.



Mild Steel Metallic Finish Supplements

- Gold - POA
- Bright Nickel - Chrome £221.00 ex VAT, £265.20 inc VAT
- Brushed Nickel - Chrome £309.00 ex VAT, £370.80 inc VAT

Chromed to a mirror finish, other finishes are available, please see page 163.



Arcadia - MS

Tube diameter	Dimensions (mm)			Bar config	Face to Face connections	Electric element wattage	Output ΔT 50°C Watts/BTU's	Output ΔT 60°C BTU's	Price (ex VAT) Chrome	Price (inc VAT) Chrome	Stock or made to order
	H	W	D								
∅ 31.8mm											
LG017-MS	850	598	233	7	453	2 x 100	439 / 1498	1893	849.00	1018.80	✓

For electric element & valve options see pages 154 & 160



Arcadia - BR

Tube diameter	Dimensions (mm)			Bar config	Face to Face connections	Electric element wattage	Output ΔT 50°C Watts/BTU's	Output ΔT 60°C BTU's	Price (ex VAT) Chrome	Price (inc VAT) Chrome	Stock or made to order
	H	W	D								
∅ 31.8mm											
LG017-BR	850	600	235	7	443	2 x 100	439 / 1498	1893	1525.00	1830.00	✘
OG017-BR	850	600	275	7	443	2 x 100	439 / 1498	1893	1870.00	2244.00	✘

Baroque

Floor Mounted LG014 / OG016

Inspired by yesteryear. The Baroque uses a classical white mild steel column radiator within a handcrafted, chrome plated, brass framework. Superior heat output and towel hanging space are abundant in this imposing feature design.



Please see pages 162 & 163 for finishes and colour options. Prices shown are chrome finished for central heating models.



Baroque

Tube diameter	Dimensions (mm)			Sections	Face to Face connections	Electric element wattage	Output ΔT 50°C Watts/BTU's	Output ΔT 60°C BTU's	Price (ex VAT) Chrome	Price (inc VAT) Chrome	Stock or made to order
	H	W	D								
∅ 31.8mm											
LG014-BR	900	675	325	8	518	200 + 300	871 / 2972	3756	1998.00	2397.60	✘
OG016-BR	900	675	350	8	518	200 + 300	871 / 2972	3756	2162.00	2594.40	✘

For electric element & valve options see pages 154 & 160



Ballerina

LG024A-MS / LG021-MS

This Ballerina wall and floor mounted towel rail offered in a mild steel Legacy ball joint version as illustrated on this page.



Mild Steel Metallic Finish Supplements

Gold - POA
 Bright Nickel -
 Chrome £221.00 ex VAT,
 £265.20 inc VAT
 Brushed Nickel -
 Chrome £309.00 ex VAT,
 £370.80 inc VAT

Prices shown are chrome finished central heating models. The high quality brass versions (opposite) are available with Legacy or Originals ball joint. The LG021-MS comes with added ball joints on the inlet connections to complement the style further.



Ballerina MS

Tube diameter Ø 31.8mm	Dimensions (mm)			Bar config	Face to Face connections	Electric element wattage	Output ΔT 50°C Watts/BTU's	Output ΔT 60°C BTU's	Price (ex VAT) Chrome	Price (inc VAT) Chrome	Stock or made to order
	H	W	D								
LG024A-MS	848	598	138	4	454	100	163 / 556	703	522.00	626.40	✓
LG021-MS	1549	598	138	5	454	150	310 / 1058	1337	582.00	698.40	✓

For electric element & valve options see pages 154 & 160



High quality brass, supremely durable for longevity. The Ballerina wall and floor is available with your choice of Legacy or Originals ball joint. Prices shown are chrome finished for all heating and hot water systems.

Ballerina

LG021 / LG024 / OG003



6 bar models are available to order as bespoke

Other finishes are available, please see page 163.



Ballerina BR

Tube diameter Ø 31.8mm	Dimensions (mm)			Bar config	Face to Face connections	Electric element wattage	Output ΔT 50°C Watts/BTU's	Output ΔT 60°C BTU's	Price (ex VAT) Chrome	Price (inc VAT) Chrome	Stock or made to order
	H	W	D								
LG024C-BR	938	575	138	3	418	100	163 / 556	703	961.00	1153.20	👇
LG024A-BR	938	675	138	3	518	125	195 / 665	841	983.00	1179.60	👇
LG024B-BR	938	825	138	3	668	150	207 / 706	893	1032.00	1238.40	👇
LG021A-BR	1238	525	138	4	368	125	239 / 815	1031	1216.00	1459.20	👇
LG021E-BR	1238	675	138	4	518	150	266 / 908	1147	1236.00	1483.20	👇
LG021D-BR	1538	525	138	5	368	150	292 / 996	1259	1260.00	1512.00	👇
LG021H-BR	1538	675	138	5	518	150	327 / 1116	1410	1356.00	1627.20	👇
OG003A-BR	938	575	138	3	418	100	163 / 556	703	1123.00	1347.60	👇
OG003B-BR	938	675	138	3	518	125	195 / 665	841	1133.00	1359.60	👇
OG003C-BR	938	825	138	3	668	150	207 / 706	893	1148.00	1377.60	👇
OG003D-BR	1238	525	138	4	368	125	239 / 815	1031	1318.00	1581.60	👇
OG003E-BR	1238	675	138	4	518	150	266 / 908	1147	1337.00	1604.40	👇
OG003F-BR	1538	525	138	5	368	125	292 / 996	1259	1490.00	1788.00	👇
OG003G-BR	1538	675	138	5	518	150	327 / 1116	1410	1512.00	1814.40	👇

For electric element & valve options see pages 154 & 160



Ballerina

Wall Mounted LG010A-MS

The Ballerina wall mounted towel rail is offered in a Legacy ball joint mild steel version, as detailed on this page.



Mild Steel Metallic Finish Supplements

- Gold - POA
- Bright Nickel - Chrome £221.00 ex VAT, £265.20 inc VAT
- Brushed Nickel - Chrome £309.00 ex VAT, £370.80 inc VAT

High quality brass, durable for longevity, the Ballerina is available with your choice of Legacy (as illustrated) or Originals ball joint.

Ballerina

Wall Mounted LG025 / LG010 / LG021 / OG002



LG Ball Joint OG Ball Joint



LG021C 5 Bars LG021B 4 Bars LG025A 3 Bars

6 bar models are available to order as bespoke



For electric element & valve options see pages 154 & 160 VL018



Prices shown are chrome finished for all heating and hot water systems.

Ballerina BR

Tube diameter Ø 31.8mm	Dimensions (mm)			Bar config	Pipe Centres	Electric element wattage	Output ΔT 50°C Watts/BTU's	Output ΔT 60°C BTU's	Price (ex VAT) Chrome	Price (inc VAT) Chrome	Stock or made to order
	H	W	D								
LG025A-BR	675	675	125	3	600	100	167 / 570	720	912.00	1094.40	👇
LG025B-BR	675	825	125	3	750	125	190 / 648	819	931.00	1117.20	👇
LG010A-BR	750	500	125	4	425	100	169 / 577	729	1006.00	1207.20	👇
LG021B-BR	1275	525	125	4	450	125	239 / 815	1031	1129.00	1354.80	👇
LG021F-BR	1275	675	125	4	600	150	266 / 908	1147	1150.00	1380.00	👇
LG021C-BR	1575	525	125	5	450	125	292 / 996	1259	1350.00	1620.00	👇
LG021G-BR	1575	675	125	5	600	150	327 / 1116	1410	1374.00	1648.80	👇
OG002B-BR	675	675	135	3	600	100	167 / 570	720	1022.00	1226.40	👇
OG002C-BR	675	825	135	3	750	125	190 / 648	819	1053.00	1263.60	👇
OG002D-BR	750	525	135	4	450	100	169 / 577	729	1235.00	1482.00	👇
OG002A-BR	1275	525	135	4	450	125	239 / 815	1047	1242.00	1490.40	👇
OG002E-BR	1275	675	135	4	600	150	266 / 908	1151	1253.00	1503.60	👇
OG002F-BR	1575	525	135	5	450	125	292 / 996	1259	1502.00	1802.40	👇
OG002G-BR	1575	675	135	5	600	150	327 / 1116	1410	1512.00	1814.40	👇

Prices shown are chrome finished central heating models.



Ballerina MS

Tube diameter Ø 31.8mm	Dimensions (mm)			Bar config	Pipe Centres	Electric element wattage	Output ΔT 50°C Watts/BTU's	Output ΔT 60°C BTU's	Price (ex VAT) Chrome	Price (inc VAT) Chrome	Stock or made to order
	H	W	D								
LG010A-MS	748	498	124	4	424	100	169 / 577	729	543.00	651.60	✓



For electric element & valve options see pages 154 & 160 VL008

Grandeur

Floor and Wall Mounted GD032FW

Reflecting the quality and craftsmanship of a bygone age. Manufactured from our most robust larger sized brass tube and ball joints. This towel rail is timeless and sits well in any traditional setting.



Image showing Antique Copper finish

Available in two heights. Brass manufactured with a chrome finish as standard. Other finishes are available, please see page 163.



Grandeur

Tube diameter	Dimensions (mm)			Bar config	Face to Face connections	Electric element wattage	Output ΔT 50°C Watts/BTU's	Output ΔT 60°C BTU's	Price (ex VAT) Chrome	Price (inc VAT) Chrome	Stock or made to order
	H	W	D								
GD032FW	943	686	163	3	522	125	243 / 829	1048	1834.00	2200.80	👉
GD032FW	1243	686	163	4	522	200	319 / 1088	1376	2294.00	2752.80	👉



Grandeur Ball Joint

For electric element & valve options see pages 154 & 160



VL008

Grandeur

Wall Mounted GD032WM

The wall mounted Grandeur provides ample warm towel hanging space. Classical looks and a robust traditional quality with larger sized brass tube and ball joints. Designed to outlive fashion. Chrome finish as standard.



Bespoke finishes are available at an additional cost, please see page 163 for other finishes.



Grandeur

Tube diameter	Dimensions (mm)			Bar config	Pipe Centres	Electric element wattage	Output ΔT 50°C Watts/BTU's	Output ΔT 60°C BTU's	Price (ex VAT) Chrome	Price (inc VAT) Chrome	Stock or made to order
	H	W	D								
GD032WM	686	686	154	3	600	100	220 / 751	949	1928.00	2313.60	👉
GD032WM	1286	636	154	4	550	150	321 / 1095	1384	2347.00	2816.40	👉



Grandeur Ball Joint

For electric element & valve options see pages 154 & 160



VL008

Butler

Floor and Wall Mounted LG035 / OG004

This traditional design is tactile and sturdy, a centrepiece for a classically designed bathroom. Brass manufactured, shown with the Originals ball joint. Chrome finish as standard.

Please note: The design will slightly alter if ordering lacquered brass or lacquered brushed brass.



Bespoke finishes are available at an additional cost, please see page 163 for other finishes.



Butler

Tube diameter Ø 31.8mm	Dimensions (mm)			Bar config	Face to Face connections	Electric element wattage	Output ΔT 50°C Watts/BTU's	Output ΔT 60°C BTU's	Price (ex VAT) Chrome	Price (inc VAT) Chrome	Stock or made to order
	H	W	D								
LG035	940	75	488	4	268	100	156 / 532	673	1026.00	1231.20	👇
OG004	965	75	488	4	268	100	156 / 532	673	1092.00	1310.40	👇



LG Ball Joint



OG Ball Joint



VL008

For electric element & valve options see pages 154 & 160

Hamlet

Wall Mounted LG037 / OG001

Small is always beautiful. The Hamlet is perfect for en suites and downstairs WCs where space is at a premium, but warm dry towels are still welcomed.



Image showing Antique Bronze finish

Brass manufactured with a chrome finish as standard with Originals or Legacy ball joints. Bespoke finishes are available at an additional cost, please see page 163 for other finishes.



LG Ball Joint



OG Ball Joint



VL008

For electric element & valve options see pages 154 & 160



Hamlet

Tube diameter Ø 31.8mm	Dimensions (mm)			Bar config	Pipe Centres	Electric element wattage	Output ΔT 50°C Watts/BTU's	Output ΔT 60°C BTU's	Price (ex VAT) Chrome	Price (inc VAT) Chrome	Stock or made to order
	H	W	D								
LG037	235	575	125	2	500	50	79 / 270	341	683.00	819.60	👇
OG001	235	575	135	2	500	50	79 / 270	341	762.00	914.40	👇

Elizabeth

Floor and Wall Mounted LG003 / OG019

With sculptured lines and quality ball joints the Elizabeth has a twist on tradition. Brass or Mild Steel manufactured models Chrome finished as standard.



Mild Steel Metallic Finish Supplements

Gold - POA

Bright Nickel -

Chrome £221.00 ex VAT, £265.20 inc VAT

Brushed Nickel -

Chrome £309.00 ex VAT, £370.80 inc VAT



LG Ball Joint



OG Ball Joint

Bespoke finishes are available at an additional cost, please see page 163 for other finishes.



Elizabeth - MS

Tube diameter ∅ 31.8 + 25 + 19mm	Dimensions (mm)			Bar config	Face to Face connections	Electric element wattage	Output ΔT 50°C Watts/BTU's	Output ΔT 60°C BTU's	Price (ex VAT) Chrome	Price (inc VAT) Chrome	Stock or made to order
	H	W	D								
LG003-MS	963	673	168	8	528	125	290 / 989	1251	519.00	622.80	✓



Elizabeth - BR

Tube diameter ∅ 31.8 + 25.4mm	Dimensions (mm)			Bar config	Face to Face connections	Electric element wattage	Output ΔT 50°C Watts/BTU's	Output ΔT 60°C BTU's	Price (ex VAT) Chrome	Price (inc VAT) Chrome	Stock or made to order
	H	W	D								
LG003A	938	675	138	7	518	150	290 / 989	1251	1197.00	1436.40	👉
LG003B	938	825	138	7	668	150	372 / 1269	1604	1235.00	1482.00	👉
OG019A	938	675	138	7	518	150	290 / 989	1251	1336.00	1603.20	👉
OG019B	938	825	138	7	668	150	372 / 1269	1604	1372.00	1646.40	👉

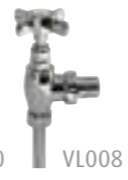

For electric element & valve options see pages 154 & 160

VL008

Elizabeth

Wall Mounted LG003 / OG019

The wall mounted Elizabeth is available in two widths with your choice of Legacy (as illustrated) or Originals ball joints. Chrome finished as standard.



LG Ball Joint



OG Ball Joint

Bespoke finishes are available at an additional cost, please see page 163 for other finishes.



Elizabeth BR

Tube diameter ∅ 31.8 + 25.4mm	Dimensions (mm)			Bar config	Pipe Centres	Electric element wattage	Output ΔT 50°C Watts/BTU's	Output ΔT 60°C BTU's	Price (ex VAT) Chrome	Price (inc VAT) Chrome	Stock or made to order
	H	W	D								
LG003D	740	675	125	7	600	125	290 / 989	1251	1226.00	1471.20	👉
LG003E	740	825	125	7	750	150	372 / 1269	1604	1266.00	1519.20	👉
OG019D	740	675	135	7	600	125	290 / 989	1251	1363.00	1635.60	👉
OG019E	740	825	135	7	750	150	372 / 1269	1604	1399.00	1678.80	👉

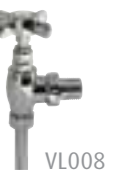

For electric element & valve options see pages 154 & 160

VL008

Art Moderne

Floor and Wall Mounted OG011

Deco decadence in a nutshell. High quality hexagonal brass tube manufacture, crafted to a gleaming finish. Available in two sizes and chrome finish as standard.



Art Moderne Corner Joint

Bespoke finishes are available at an additional cost, please see page 163 for other finishes.



Art Moderne

Tube diameter Ø 32mm HEX	Dimensions (mm)			Bar config	Face to Face connections	Electric element wattage	Output ΔT 50°C Watts/BTU's	Output ΔT 60°C BTU's	Price (ex VAT) Chrome	Price (inc VAT) Chrome	Stock or made to order
	H	W	D								
OG011B	943	600	175	3	428	100	197 / 672	850	1164.00	1396.80	👤
OG011A	1543	550	168	5	378	125	318 / 1085	1371	1460.00	1752.00	👤

For electric element & valve options see pages 154 & 160



VL008

Perfect for any bathroom with Deco sanitary and brassware, this ever popular style never fades. The wall mounted Art Moderne is available in three different sizes to suit your room. Brass manufactured with a chrome finish as standard.

Art Moderne

Wall Mounted OG010



Art Moderne Corner Joint

Bespoke finishes are available at an additional cost, please see page 163 for other finishes.



Art Moderne

Tube diameter Ø 32mm HEX	Dimensions (mm)			Bar config	Pipe Centres	Electric element wattage	Output ΔT 50°C Watts/BTU's	Output ΔT 60°C BTU's	Price (ex VAT) Chrome	Price (inc VAT) Chrome	Stock or made to order
	H	W	D								
OG010A	836	550	145	4	450	100	211 / 720	910	1219.00	1462.80	👤
OG010B	836	700	145	4	600	125	247 / 843	1065	1250.00	1500.00	👤
OG010C	986	700	145	4	600	125	263 / 897	1134	1272.00	1526.40	👤

For electric element & valve options see pages 154 & 160



VL006

Art Moderne II

Wall Mounted OG021

Quality hexagonal brass tube meets a practical brass multirail for an elegant look. Chrome finished as standard. Bespoke finishes are available at an additional cost, please see page 163 for other finishes.



Unique Art Moderne joint with hexagonal upright and round horizontals



This characterful robustly British towel warmer hails quality and craftsmanship. Made for you with your choice of the Legacy or Originals ball joint (pictured). Brass manufactured with a chrome finish as standard.

Penthouse

Wall Mounted LG018 / OG020



LG Ball Joint



OG Ball Joint



Art Moderne II

Tube diameter Ø 32 HEX + 25.4mm	Dimensions (mm)			Bar config	Pipe Centres	Electric element wattage	Output ΔT 50°C Watts/BTU's	Output ΔT 60°C BTU's	Price (ex VAT) Chrome	Price (inc VAT) Chrome	Stock or made to order
	H	W	D								
OG021	700	532	83 - 106	7-7	500	125	354 / 1208	1527	1199.00	1438.80	👉
OG021	1000	482	83 - 106	6-6-6	450	150	429 / 1464	1850	1321.00	1585.20	👉
OG021	1200	482	83 - 106	5-5-5-5	450	200	487 / 1662	2100	1456.00	1747.20	👉

For electric element & valve options see pages 154 & 160



VL008



Penthouse

Tube diameter Ø 31.8 + 25.4mm	Dimensions (mm)			Bar config	Pipe Centres	Electric element wattage	Output ΔT 50°C Watts/BTU's	Output ΔT 60°C BTU's	Price (ex VAT) Chrome	Price (inc VAT) Chrome	Stock or made to order
	H	W	D								
LG018	1100	550	100	20	500	200	532 / 1815	2294	1707.00	2048.40	👉
OG020	1100	550	100	18	500	200	493 / 1682	2126	1902.00	2282.40	👉

Bespoke finishes are available at an additional cost, please see page 163 for other finishes.

For electric element & valve options see pages 154 & 160



VL018

Colonnade IV

Wall Mounted LG023

The distinguished design features both rope and reed tubing providing a stand-out product. Manufactured from high quality brass with a chrome finish as standard. Bespoke finishes are available at an additional cost.

Featuring both rope and reed tubing



Rope

Reed



Image showing Antique Copper finish



Colonnade IV

Tube diameter	Dimensions (mm)			Bar config	Pipe Centres	Electric element wattage	Output ΔT 50°C Watts/BTU's	Output ΔT 60°C BTU's	Price (ex VAT) Chrome	Price (inc VAT) Chrome	Stock or made to order
	H	W	D								
\varnothing 25.4mm											
LG023A	775	475	125	4	400	100	169 / 577	729	1096.00	1315.20	🚫
LG023B	775	575	125	4	500	100	190 / 648	819	1174.00	1408.80	🚫

For electric element & valve options see pages 154 & 160



VL008

Vintage

Wall Mounted LG010B

This chrome finished brass tubed simple design with Legacy ball joints would sit happily in either a traditional or more contemporary setting. Bespoke finishes are available at an additional cost, please see page 163 for other finishes.



Prices shown are for chrome finished models.



Vintage

Tube diameter	Dimensions (mm)			Bar config	Pipe Centres	Electric element wattage	Output ΔT 50°C Watts/BTU's	Output ΔT 60°C BTU's	Price (ex VAT) Chrome	Price (inc VAT) Chrome	Stock or made to order
	H	W	D								
\varnothing 31.8mm											
LG010B	750	475	105	4	400	100	169 / 577	729	776.00	931.20	✅

For electric element & valve options see pages 154 & 160



VL008

Nexus Grand III

Wall Mounted TM003

When combinations are right, something good happens. This towel rail has a great heat output from a twin column radiator inset. It is skilfully combined in a brass framework and chrome plated.



The two column radiator inset comes in white as standard, other colours can be specified at an additional cost. Please see pages 162 & 163 for finishes and colour options. Prices shown are chrome finished for central heating models.



Nexus Grand III

TM003	Dimensions (mm)			Sections	Pipe Centres	Electric element wattage	Output	Output	Price (ex VAT) Chrome	Price (inc VAT) Chrome	Stock or made to order	
	Tube diameter	H	W				D	ΔT 50°C Watts/BTU's				ΔT 60°C BTU's
	Ø 25.4 + 15mm	900	525	142 - 160	8	500	400	726 / 2477	3131	1184.00	1420.80	👤

For electric element & valve options see pages 154 & 160



VL008

This single curved bar version is a more modern take on the traditional. The mild steel two column radiator inset comes in white as standard, other colours can be specified at an additional cost.

Nexus Grand IV

Wall Mounted TM004



Quality brass manufactured framework. Please see pages 162 & 163 for finishes and colour options. Prices shown are chrome finished for central heating models.



Nexus Grand IV

TM004	Dimensions (mm)			Sections	Pipe Centres	Electric element wattage	Output	Output	Price (ex VAT) Chrome	Price (inc VAT) Chrome	Stock or made to order	
	Tube diameter	H	W				D	ΔT 50°C Watts/BTU's				ΔT 60°C BTU's
	Ø 25.4 + 22mm	900	590	214 - 232	8	500	400	699 / 2385	3015	1192.00	1430.40	👤

For electric element & valve options see pages 154 & 160



VL008

Sequel III

Wall Mounted TM005

The Sequel III is manufactured from high quality brass, with a three column mild steel inset radiator, which comes in white as standard, other colours can be specified at an additional cost. Curved hanging bars give a modern edge to this traditional style.



Please see pages 162 & 163 for finishes and colour options. Prices shown are chrome finished for central heating models.



Sequel III

Tube diameter Ø 25.4 + 15mm	Dimensions (mm)			Sections	Pipe Centres	Electric element wattage	Output ΔT 50°C Watts/BTU's	Output ΔT 60°C BTU's	Price (ex VAT) Chrome	Price (inc VAT) Chrome	Stock or made to order
	H	W	D								
TM005	1000	550	182-200	5	475	400	741 / 2528	3196	1409.00	1690.80	👤

For electric element & valve options see pages 154 & 160



VL006

Sequel V

Wall Mounted TM006

The Sequel V has Legacy ball joints and emits a fine traditional sense of style. With brass manufactured framework and a white three column mild steel integral radiator it produces a high heat output. Other radiator colours can be specified.



Prices shown are chrome finished for central heating models. See pages 162 & 163 for finishes and colour options.



Sequel V

Tube diameter Ø 25.4mm	Dimensions (mm)			Sections	Pipe Centres	Electric element wattage	Output ΔT 50°C Watts/BTU's	Output ΔT 60°C BTU's	Price (ex VAT) Chrome	Price (inc VAT) Chrome	Stock or made to order
	H	W	D								
TM006	1000	525	191-209	5	475	400	716 / 2443	3088	1364.00	1636.80	👤

For electric element & valve options see pages 154 & 160



VL018

Basin Stands

Floor and Wall Mounted



Heated or Unheated Basin Stands

Vogue have developed a range of handcrafted brass basin stands produced to order. The styles illustrated can be altered to suit your exact requirements with your choice of metallic finish. Other finishes are available, please see page 163.

Please contact us for further information and a specific quotation.



Kensington BSS004
As pictured with nickel finish (left)



Mayfair BSS003
To suit rounded basins



Chelsea BSS006
Pictured heated and wall mounted



City BSS007
Wall mounted with Art Linea joints

Richmond BSS001

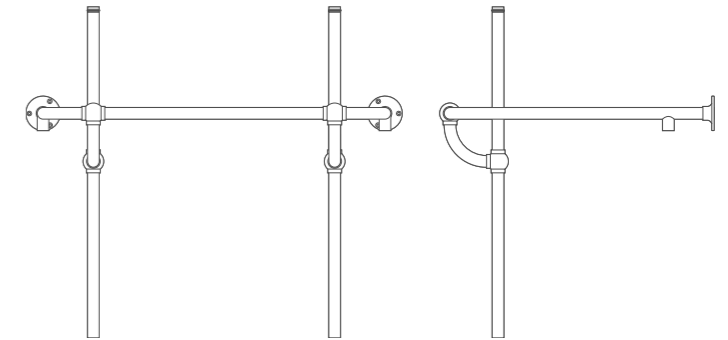

Linea Richmond BSS002

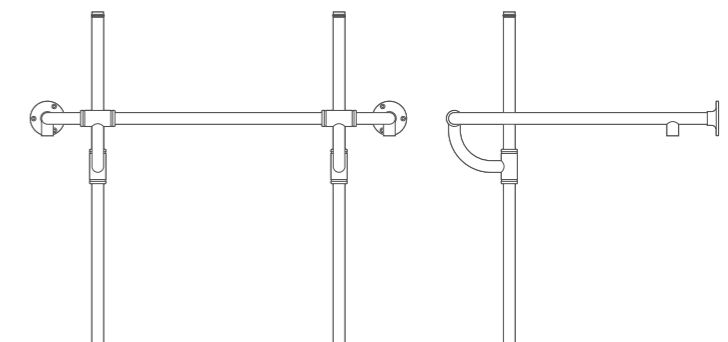

Belgravia BSS005

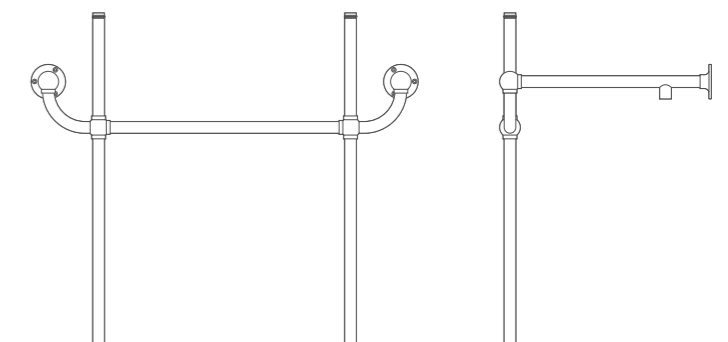

Shower Curtain Rails

Wall Mounted

Complement Your Bathroom...

Our handmade range of shower curtain rails are beautifully engineered from high quality brass tubing for longevity. As standard they are finished in chrome. Please talk to us if you require other metallic finishes or non standard sizes. Other finishes are available, please see page 163.

Oval Ceiling Mounted SCR 1
Ø 25.4mm



Single Ended Oval Wall and Ceiling Mounted SCR 2
Ø 25.4mm

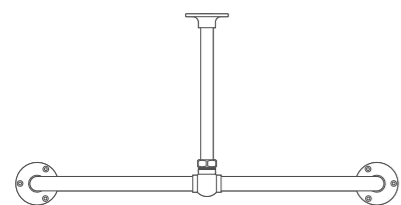
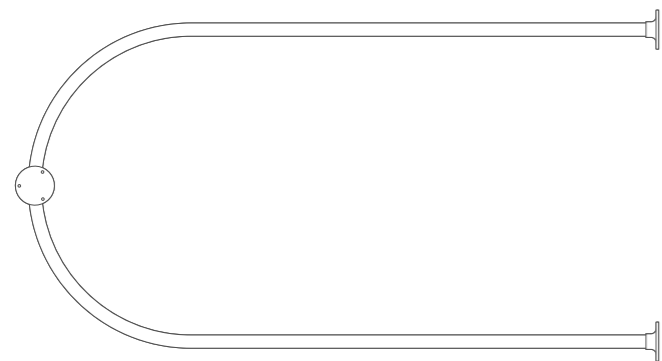

Straight Wall Mounted SCR 3
Ø 31.8mm

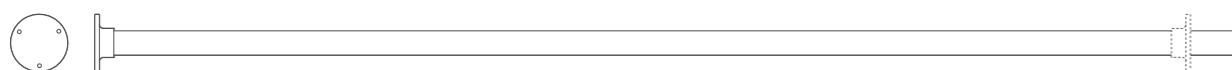

Curved Corner Wall Mounted SCR 4
Ø 25.4mm

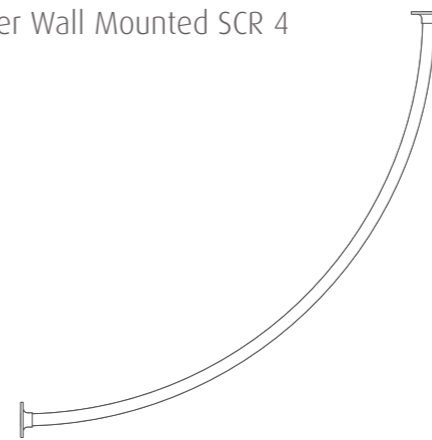

Circular wall Mounted SCR 5
Ø 25.4mm



Right Angle Wall Mounted SCR 6
Ø 25.4mm

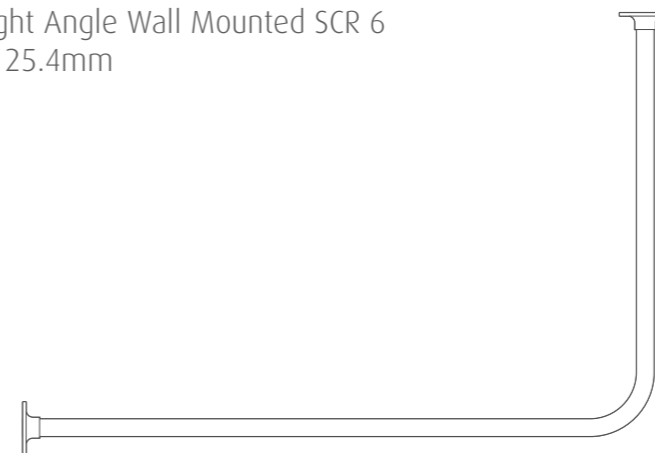

Shower Curtain Rail

	Dimensions (mm)			Description	Price (ex VAT) Chrome	Price (inc VAT) Chrome	Stock or made to order
	H	W	D				
SCR 1.1	325	1275	625	Oval shape mounted to ceiling	635.00	762.00	👉
SCR 1.2	325	1625	625	Oval shape mounted to ceiling	654.00	784.80	👉
SCR 2.1	338	1238	675	Single ended oval shape mounted to wall and ceiling	620.00	744.00	👉
SCR 2.2	338	1538	675	Single ended oval shape mounted to wall and ceiling	682.00	818.40	👉
SCR 3.1	75	1700	75	Straight wall mounted bar	384.00	460.80	👉
SCR 3.2	75	2000	75	Straight wall mounted bar	432.00	518.40	👉
SCR 4.1	75	938	938	Round curve for corner applications	421.00	505.20	👉
SCR 4.2	75	1238	1238	Round curve for corner applications	451.00	541.20	👉
SCR 5.1	75	775dia	827	Circular wall mounted	395.00	474.00	👉
SCR 5.2	75	925dia	977	Circular wall mounted	432.00	518.40	👉
SCR 6.1	75	938	638	Right angled curve for corner applications	408.00	489.60	👉
SCR 6.2	75	1238	638	Right angled curve for corner applications	443.00	531.60	👉
SCR 6.3	75	1538	638	Right angled curve for corner applications	482.00	578.40	👉



Designer Radiators

Looking for a real statement piece?

Our exclusive designer radiators are constantly leading the trend in interior design. Created by some of the UK's most celebrated interior designers, they are guaranteed to turn heads.

Suave

Wall Mounted MD056

The Suave has a strong, minimalist design, ideal for more contemporary properties. Manufactured in high quality mild steel and finished in anthracite or white. Please see page 162 for colour options.

Optional Accessory



Towel Bar - Chrome
AC030 (443mm wide)
£158.00 ex VAT,
£189.60 inc VAT



Zest

Wall Mounted MD076

The Zest is a bold contemporary radiator. Manufactured in high quality mild steel and finished in anthracite or white. Please see page 162 for colour options.



MS C D E

Suave

MD056	Dimensions (mm)			Pipe Centres	Electric element wattage	Output ΔT 50°C Watts/BTU's	Output ΔT 60°C BTU's	Price		Stock or made to order
	H	W	D					Anthracite or White (ex VAT)	(inc VAT)	
MD056	1800	500	85-100	450	600	669 / 2283	2885	578.00	693.60	✓



For electric element & valve options see pages 154 & 160

VL003

MS C D E

Zest

MD076	Dimensions (mm)			Pipe Centres	Electric element wattage	Output ΔT 50°C Watts/BTU's	Output ΔT 60°C BTU's	Price		Stock or made to order
	H	W	D					Anthracite or White (ex VAT)	(inc VAT)	
MD076	1800	500	85-100	451	600	667 / 2276	2877	665.00	798.00	✓



For electric element & valve options see pages 154 & 160

VL003

Kate

Wall Mounted DR019

A contemporary radiator with cylindrical uprights available in white. Manufactured from mild steel, suitable for closed heating systems.



Ordinate

Wall Mounted MD005

A bold and clean lined tubular radiator. The Ordinate will integrate well into any room of the house and available in four heights. The picture illustrates the tallest model. Available as single or double versions in White Sparkle Textured or Anthracite.



Clip-on Robe Hook
AC031 £52.00 (ex VAT)

Clip-on Towel Bar
AC023B 305mm wide £141.00 (ex VAT)
AC023C 395mm wide £152.00 (ex VAT)



For valve options see page 160 VL003



Towel Bar - White or Chrome
AC041 £62.00 (ex VAT)



For valve options see page 160 VL003

Kate

Tube diameter Ø 32 + 38mm	Dimensions (mm)			End to End connections	Output ΔT 50°C Watts/BTU's	Output ΔT 60°C BTU's	Price (ex VAT) White	Price (inc VAT) White	Stock or made to order
	H	W	D						
DR019	1800	370	134	370	700 / 2388	3019	534.00	640.80	✓



Ordinate Colours

Tube diameter Ø 22 + 32mm	Dimensions (mm)			Bar config	End to End connections	Output ΔT 50°C Watts/BTU's	Output ΔT 60°C BTU's	Price Anthracite		Price White Sparkle Textured		Stock or made to order
	H	W	D					(ex VAT)	(inc VAT)	(ex VAT)	(inc VAT)	
MD005	1800	525	113-128	12	525	676 / 2307	2915	435.00	522.00	478.00	573.60	✓
MD005	1800	595	113-128	13	595	734 / 2504	3166	495.00	594.00	514.00	616.80	✓
MD005DP Double	1800	525	99	12-12	525	914 / 3119	3942	786.00	943.20	849.00	1018.80	✓
MD005DP Double	1800	595	99	13-13	595	992 / 3146	3976	883.00	1059.60	941.00	1129.20	✓

Vision

Wall Mounted DR022

A full length mirror built into a stylish tubular radiator makes Vision an asset in every room in your home. Manufactured from high quality mild steel and available in a Chrome, White or Anthracite finish to blend with any décor.



Serenade is a vertical contemporary design radiator, manufactured from high quality mild steel with finish options of chrome, textured matt black & white. Please see page 162 for colour options.



Serenade

Wall Mounted DR008



Optional Accessory

Towel Bar - White, Chrome or Black
AC039A (266mm wide)
AC039B (375mm wide)
£57.00 ex VAT,
£68.40 inc VAT

Mild Steel Metallic Finish Supplements

Gold - POA
Bright Nickel -
Chrome £221.00 ex VAT,
£265.20 inc VAT
Brushed Nickel -
Chrome £309.00 ex VAT,
£370.80 inc VAT



VL014

For valve options see page 160

MS C

Vision

Tube diameter	Dimensions (mm)			End to End connections	Output ΔT 50°C Watts/BTU's		Output ΔT 60°C BTU's		Price Chrome		Price Anthracite or White		Stock or made to order
	H	W	D		Chrome	A & W	Chrome	A & W	(ex VAT)	(inc VAT)	(ex VAT)	(inc VAT)	
DR022	1800	600	104	600	473 / 1614	713 / 2433	2040	3075	966.00	1159.20	897.00	1076.40	✓



VL003

For valve options see page 160

MS C

Serenade

Tube diameter	Dimensions (mm)			Bar config	End to End connections	Output ΔT 50°C Watts/BTU's		Output ΔT 60°C BTU's		Price Chrome		Price Black or White		Stock or made to order		
	∅	40 x 10mm	H			W	D	chrome	painting	chrome	painting	(ex VAT)	(inc VAT)		(ex VAT)	(inc VAT)
DR008	30mm	40 x 10mm	1200	252	70	5	252	242 / 826	367 / 1252	1044	1583	331.00	397.20	255.00	306.00	✓
DR008	30mm	40 x 10mm	1200	358	70	7	358	339 / 1157	515 / 1757	1462	2221	382.00	458.40	286.00	343.20	✓
DR008	30mm	40 x 10mm	1800	252	70	5	252	351 / 1198	533 / 1819	1514	2299	391.00	469.20	310.00	372.00	✓
DR008	30mm	40 x 10mm	1800	358	70	7	358	491 / 1675	746 / 2545	2118	3217	593.00	711.60	369.00	442.80	✓

Fly Line Vertical

Wall Mounted DR003

Fly Line is a strong, minimalist design ideal for contemporary properties. These radiators come with a choice of single or double panel versions with the double panel offering an increased heat output.



Showing double panel design
Fly Line Vertical in white

Fly Line Vertical and Horizontal are available in a variety of size options and come as standard in white or anthracite. Please see page 162 for colour options, available on single panel versions only.



For valve options see page 160  VL003

Fly Line Vertical

Tube diameter 38mm 70 x 11mm	Dimensions (mm)			No. of sections	End to End connections	Output ΔT 50°C Watts/BTU's	Output ΔT 60°C BTU's	Price Anthracite		Price White		Stock or made to order
	H	W	D					(ex VAT)	(inc VAT)	(ex VAT)	(inc VAT)	
DR003 (single panel)	1800	224	71	3	224	402 / 1372	1734	278.00	333.60	436.00	523.20	✓
DR003 (single panel)	1800	376	71	5	376	670 / 2286	2890	380.00	456.00	375.00	450.00	✓
DR003 (single panel)	1800	528	71	7	528	938 / 3200	4045	481.00	577.20	476.00	571.20	✓
DR003 (single panel)	1800	680	71	9	680	1206 / 4115	5201	582.00	698.40	576.00	691.20	✓
DR003DP (double panel)	1800	224	71	3	224	627 / 2139	2704	438.00	469.20	389.00	466.80	✓
DR003DP (double panel)	1800	376	71	5	376	1045 / 3566	4507	638.00	765.60	636.00	763.20	✓
DR003DP (double panel)	1800	528	71	7	528	1463 / 4992	6310	836.00	1003.20	833.00	999.60	✓
DR003DP (double panel)	1800	680	71	9	680	1881 / 6418	8112	1034.00	1240.80	1030.00	1236.00	✓

Fly Line Horizontal

Wall Mounted DR004



For valve options see page 160  VL003

Fly Line Horizontal

Tube diameter 38mm 70 x 11mm	Dimensions (mm)			No. of sections	Pipe centres	Output ΔT 50°C Watts/BTU's	Output ΔT 60°C BTU's	Price Anthracite		Price White		Stock or made to order
	H	W	D					(ex VAT)	(inc VAT)	(ex VAT)	(inc VAT)	
DR004 (single panel)	452	900	63	6	850	420 / 1433	1811	315.00	378.00	313.00	375.60	✓
DR004 (single panel)	452	1200	63	6	1150	552 / 1883	2381	357.00	428.40	354.00	424.80	✓
DR004 (single panel)	604	900	63	8	850	560 / 1911	2415	381.00	457.20	379.00	454.80	✓
DR004 (single panel)	604	1200	63	8	1150	736 / 2511	3174	435.00	522.00	432.00	518.40	✓
DR004DP (double panel)	452	900	112	6	850	654 / 2231	2821	531.00	637.20	528.00	633.60	✓
DR004DP (double panel)	452	1200	112	6	1150	858 / 2927	3700	604.00	724.80	601.00	721.20	✓
DR004DP (double panel)	604	900	112	8	850	872 / 2975	3761	666.00	799.20	664.00	796.80	✓
DR004DP (double panel)	604	1200	112	8	1150	1144 / 3903	4934	762.00	914.40	759.00	910.80	✓

Fly Line II Vertical

Wall Mounted DR001

Manufactured from high quality aluminium, Fly Line II offers a supreme heat output and sleek good looks. Available in white or anthracite as single or double panelled in a variety of sizes.



Fly Line II Horizontal

Wall Mounted DR002



Also available in anthracite finish

NEW January 2023



AL H

Fly Line II Vertical

Tube diameter 30mm 70 x 39.5 / 58mm	Dimensions (mm)			No. of sections	End to End connections	Output ΔT 50°C Watts/BTU's	Output ΔT 60°C BTU's	Price		Stock or made to order
	H	W	D					Anthracite / White (ex VAT)	(inc VAT)	
DR001SP (single panel)	1800	218	66	3	220	642 / 2190	2775	246.00	295.20	✓
DR001SP (single panel)	1800	366	66	5	370	1070 / 3651	4626	374.00	448.80	✓
DR001SP (single panel)	1800	514	66	7	520	1499 / 5113	6478	502.00	602.40	✓
DR001SP (single panel)	1800	662	66	9	670	1927 / 6574	8329	633.00	759.60	✓
DR001DP (double panel)	1800	218	92	3	220	1109 / 3783	4793	331.00	397.20	✓
DR001DP (double panel)	1800	366	92	5	370	1849 / 6308	7992	513.00	615.60	✓
DR001DP (double panel)	1800	514	92	7	520	2589 / 8833	11191	694.00	832.80	✓
DR001DP (double panel)	1800	662	92	9	670	3329 / 11358	14391	879.00	1054.80	✓



For valve options see page 160 VL003

AL H

Fly Line II Horizontal

Tube diameter 30mm 70 x 39.5 / 58mm	Dimensions (mm)			No. of sections	Pipe centres	Output ΔT 50°C Watts/BTU's	Output ΔT 60°C BTU's	Price		Stock or made to order
	H	W	D					Anthracite / White (ex VAT)	(inc VAT)	
DR002SP (single panel)	440	900	75	6	870	680 / 2319	2938	254.00	304.80	✓
DR002SP (single panel)	440	1200	75	6	1150	881 / 3006	3809	316.00	379.20	✓
DR002SP (single panel)	588	900	75	8	870	906 / 3092	3918	324.00	388.80	✓
DR002SP (single panel)	588	1200	75	8	1150	1175 / 4009	5079	405.00	486.00	✓
DR002DP (double panel)	440	900	122	6	870	1161 / 3960	5017	357.00	428.40	✓
DR002DP (double panel)	440	1200	122	6	1150	1513 / 5163	6542	439.00	526.80	✓
DR002DP (double panel)	588	900	122	8	870	1548 / 5281	6691	460.00	552.00	✓
DR002DP (double panel)	588	1200	122	8	1150	2018 / 6886	8725	569.00	682.80	✓



For valve options see page 160 VL003

Lure Single

Wall Mounted DR020

A statement piece that oozes sophistication and practical good looks, with a bank of closely fitting oval tubes to provide aesthetic appeal and efficient heat output. Available in chrome or white. Please see page 162 for colour options.



Unique oval tubing



Lure Single

Tube diameter	Dimensions (mm)			Bar config	End to End connections	Output		Price		Stock or made to order					
	Ø	□				ΔT 50°C Watts/BTU's	ΔT 60°C BTU's	Chrome	White						
32mm	25 x 50mm oval	H	W	D		chrome	white	chrome	white	(ex VAT)	(inc VAT)	(ex VAT)	(inc VAT)		
DR020		1800	352	83	6	352	505 / 1723	722 / 2463	2178	3114	546.00	655.20	351.00	421.20	✓

For valve options see page 160



VL003

Lure Double

Wall Mounted DR020DP

A modern designer radiator with twin rows of oval tubes for elegance and high output available in white or anthracite. Manufactured from mild steel, suitable for closed heating systems.



Lure Double

Tube diameter	Dimensions (mm)			Bar config	End to End connections	Output		Price		Stock or made to order		
	Ø	□				ΔT 50°C Watts/BTU's	ΔT 60°C BTU's	White or Anthracite	White or Anthracite			
32mm	25 x 50mm oval	H	W	D		White or Anthracite	White or Anthracite	White or Anthracite	White or Anthracite	(ex VAT)	(inc VAT)	
DR020DP		1800	352	105-110	6	352	1014 / 3460	4373	506.00	607.20		✓

For valve options see page 160



VL003

Astute Horizontal

Aluminium Wall Mounted DR036

Provides great efficiency, easy to install with its lightweight material and has low water content, enabling a quick heat up time. Available in white or anthracite.



Compact aluminium radiator to fit the smallest of space while providing the benefits of low water content and quick heat up. Available in textured black, anthracite and white.

Astute Compact

Aluminium Wall Mounted DR034

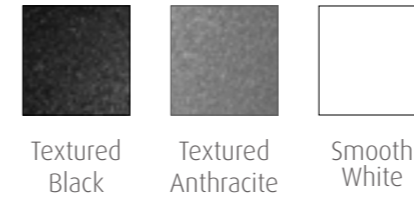
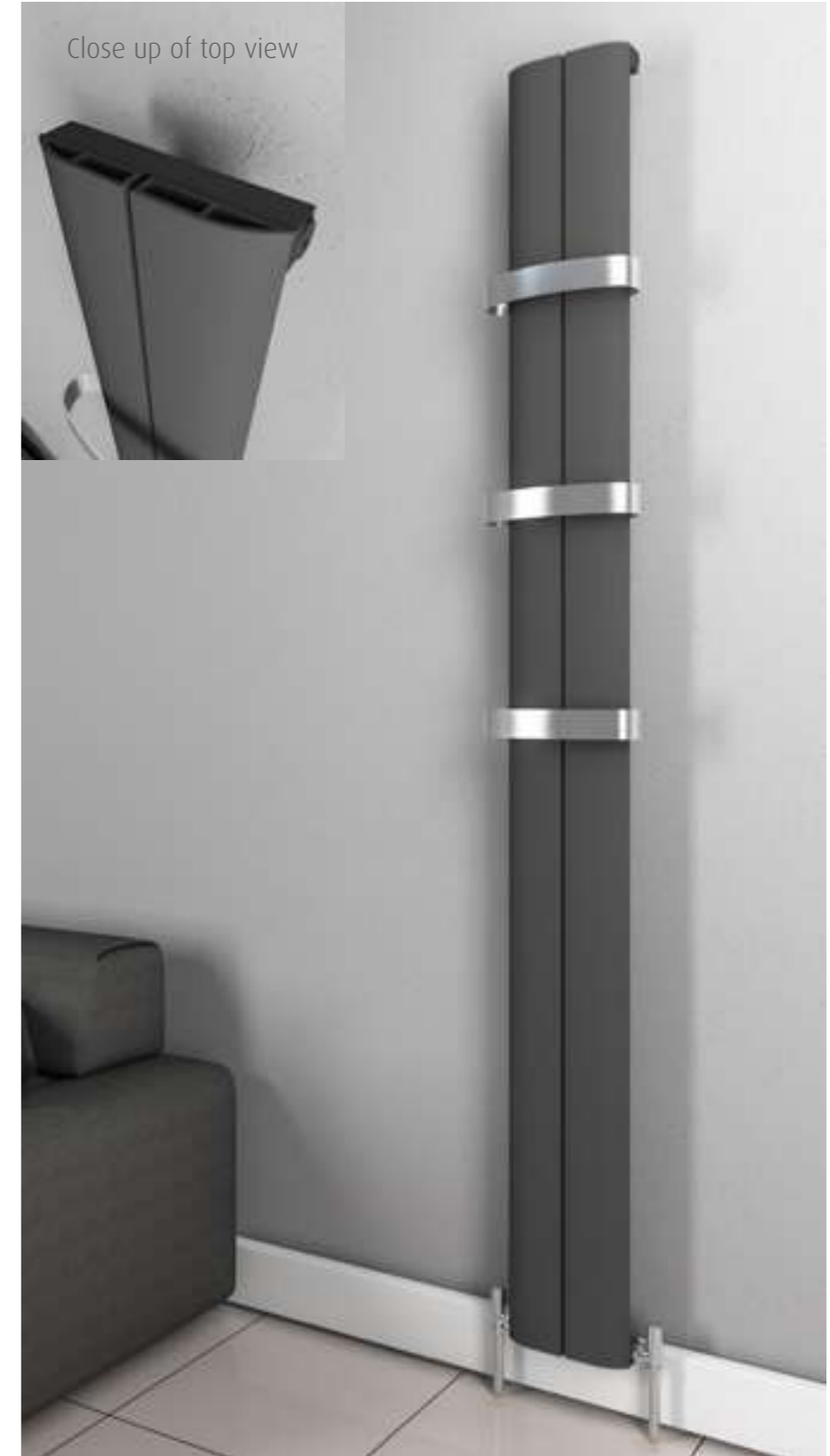

Textured Black Textured Anthracite Smooth White

Optional Accessory



Towel Bar -
Chrome, Textured Black,
Textured Anthracite or
Textured White

AC064 (230mm wide)
£50.00 ex VAT,
£60.00 inc VAT

AL H

Astute Horizontal

	Dimensions (mm)			Sections	End to End connections	Output ΔT 50°C Watts/BTU's	Output ΔT 60°C BTU's	Price White		Price Anthracite		Stock or made to order
	H	W	D					(ex VAT)	(inc VAT)	(ex VAT)	(inc VAT)	
DR036 (single panel)	600	565	76.5	6	565	506/1726	2182	332.00	398.40	345.00	414.00	✓
DR036 (single panel)	600	755	76.5	8	755	674/2300	2907	395.00	474.00	403.00	483.60	✓
DR036 (single panel)	600	945	76.5	10	945	842/2873	3631	465.00	558.00	480.00	576.00	✓
DR036 (single panel)	600	1135	76.5	12	1135	1011/3450	4360	537.00	644.40	553.00	663.60	✓
DR036 (single panel)	600	1325	76.5	14	1325	1147/3914	4947	607.00	728.40	625.00	750.00	✓
DR036 (single panel)	600	1515	76.5	16	1515	1342/4579	5788	676.00	811.20	699.00	838.80	✓

DR036DP (double panel)	600	560	117.5	6	560	841 / 2869	3627	419.00	502.80	428.00	513.60	✓
DR036DP (double panel)	600	748	117.5	8	748	1121 / 3825	4835	515.00	618.00	526.00	631.20	✓
DR036DP (double panel)	600	936	117.5	10	936	1401 / 4780	6042	611.00	733.20	624.00	748.80	✓
DR036DP (double panel)	600	1124	117.5	12	1124	1654 / 5643	7133	727.00	872.40	741.00	889.20	✓
DR036DP (double panel)	600	1312	117.5	14	1312	1908 / 6510	8229	826.00	991.20	844.00	1012.80	✓

For valve options see page 160  VL003

For electric element and valve options see pages 154 & 160  VL003

AL H E D

Astute Compact

	Dimensions (mm)			Sections	End to End connections	Electric element wattage	Output ΔT 50°C Watts/BTU's	Output ΔT 60°C s BTU's	Price (ex VAT) Colours	Price (inc VAT) Colours	Stock or made to order
	H	W	D								
DR034	1800	185	90	2	185	300	436 / 1488	1880	218.00	261.60	✓

*Elements can only be fitted in the tapping provided at the bottom right hand side of the radiator.

Astute Vertical Single

Aluminium Wall Mounted DR035

Provides great efficiency, easy to install with its lightweight material. Has a low water content so has a quick heat up time. Available in white or anthracite.



Optional Accessory



Towel Bar - Chrome

AC066 (320mm wide)
£69.00 ex VAT,
£82.80 inc VAT

AC066 (415mm wide)
£91.00 ex VAT,
£109.20 inc VAT

AC066 (510mm wide)
£116.00 ex VAT,
£139.20 inc VAT

AL H

VL003

For valve options see page 160



Astute Vertical Single

	Dimensions (mm)			Sections	End to End connections	Output ΔT 50°C Watts/BTU's	Output ΔT 60°C BTU's	Price White		Price Anthracite		Stock or made to order
	H	W	D					(ex VAT)	(inc VAT)	(ex VAT)	(inc VAT)	
DR035	1800	280	76.5	3	280	843/ 2876	3636	343.44	412.13	352.98	423.58	✓
DR035	1800	375	76.5	4	375	1124/ 3835	4848	419.76	503.71	434.60	521.52	✓
DR035	1800	470	76.5	5	470	1405/ 4794	6059	496.08	595.30	514.10	616.92	✓

Astute Vertical Double

Aluminium Wall Mounted DR035DP

Designed for the home, providing great efficiency. Has a low water content, enabling a quick heat up time. Available in white or anthracite.

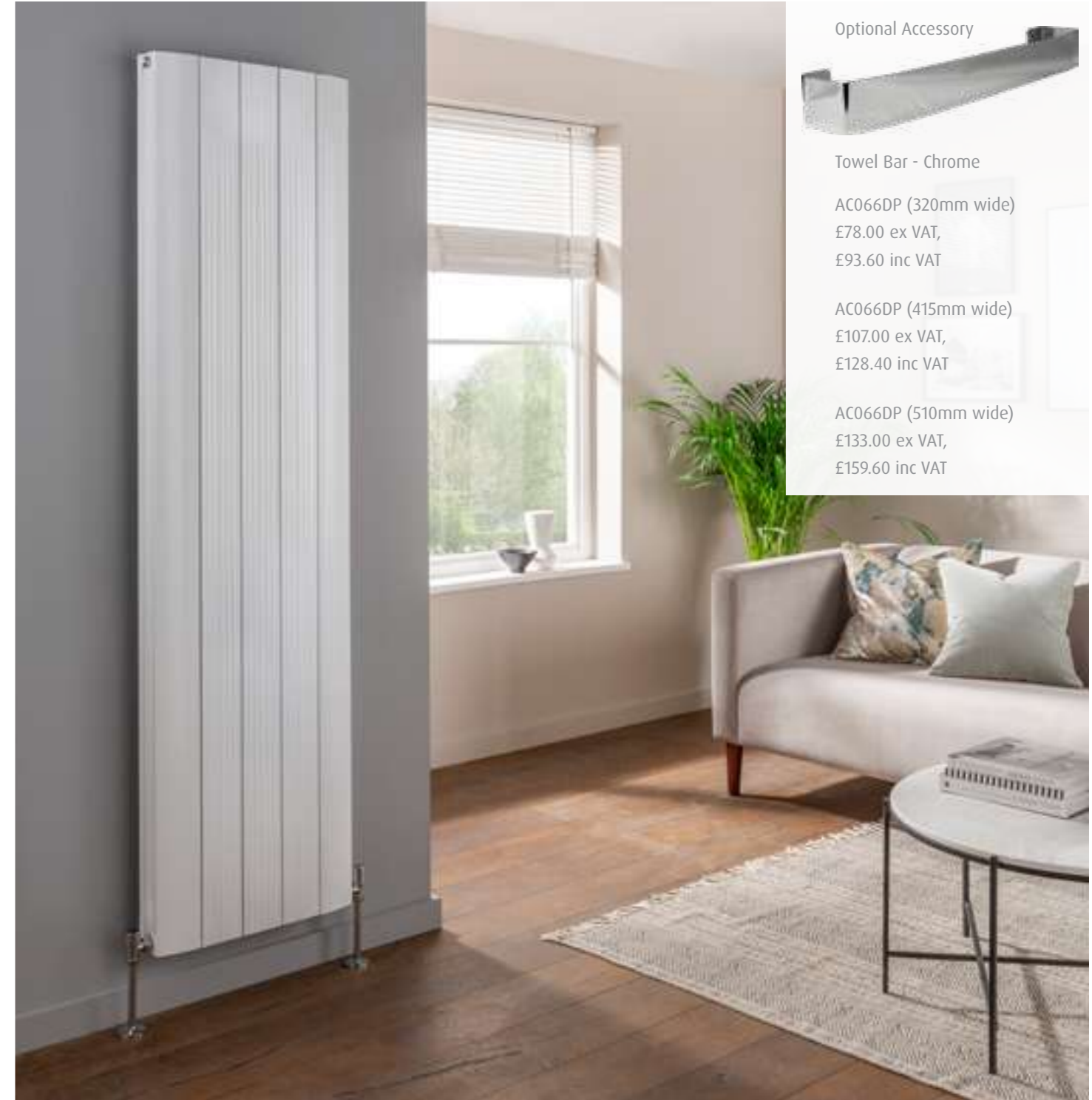

Optional Accessory



Towel Bar - Chrome

AC066DP (320mm wide)
£78.00 ex VAT,
£93.60 inc VAT

AC066DP (415mm wide)
£107.00 ex VAT,
£128.40 inc VAT

AC066DP (510mm wide)
£133.00 ex VAT,
£159.60 inc VAT

AL H



VL003

For valve options see page 160

Astute Vertical Double

	Dimensions (mm)			Sections	End to End connections	Output ΔT 50°C Watts/BTU's	Output ΔT 60°C BTU's	Price White		Price Anthracite		Stock or made to order
	H	W	D					(ex VAT)	(inc VAT)	(ex VAT)	(inc VAT)	
DR035DP	1800	278	117.5	3	278	1441/ 4917	6215	484.42	581.30	495.02	594.02	✓
DR035DP	1800	372	117.5	4	372	1916/ 6537	8263	598.90	718.68	613.74	736.49	✓
DR035DP	1800	466	117.5	5	466	2348/ 8011	10126	714.44	857.33	731.40	877.68	✓

Mode II

Wall or Floor Mounted CN027

Contemporary styling with sleek rounded tubes. Mode II has all the attributes of a great column radiator with edgy attitude. These wall hung radiators will complement many areas of the home. Available in white RAL 9016 and Metallic Anthracite as standard. Please see page 162 for colour options.

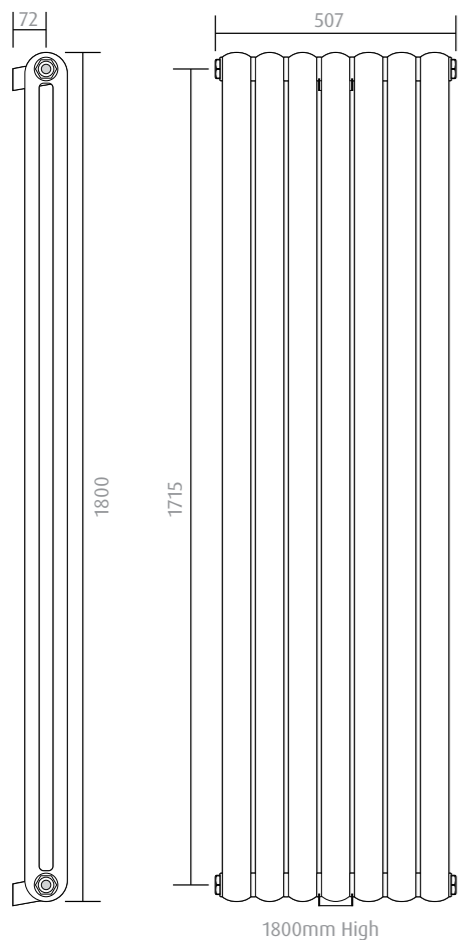

Optional Accessories

Towel Bar - White, Chrome or Anthracite

AC034A (60 x 200mm wide)

AC034B (60 x 340mm wide)

AC034C (60 x 480mm wide)

£71.00 ex VAT,

£85.20 inc VAT



Feet - White or Anthracite

AC038

£35.00 ex VAT,

£42.00 inc VAT



Metallic Anthracite option
(non-textured)

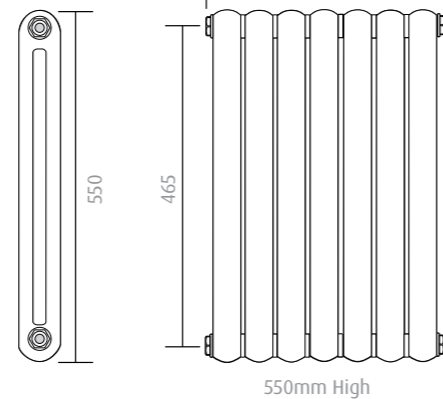
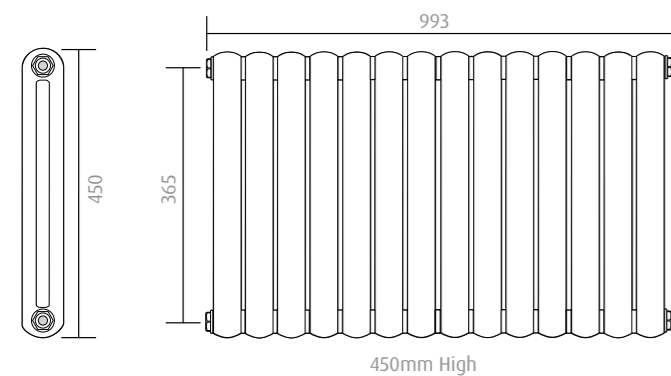

For valve options see page 160 VL003

Mode II

Model	Dimensions (mm)			Number of Sections	Output ΔT 50°C Watts/BTU's	Output ΔT 60°C BTU's	Price (ex VAT) White or Anthracite	Price (inc VAT) White or Anthracite	Stock or made to order
	H	W	D						
CN027	450	507	90	7	398 / 1358	1716	324.50	389.40	✓
CN027	450	785	90	11	625 / 2133	2695	434.50	521.40	✓
CN027	450	993	90	14	796 / 2716	3433	631.40	757.68	✓
CN027	450	1202	90	17	966 / 3296	4166	763.40	916.08	✓
CN027	550	507	90	7	505 / 1723	2178	366.30	439.56	✓
CN027	550	785	90	11	793 / 2706	3420	489.50	587.40	✓
CN027	550	993	90	14	1009 / 3443	4352	717.20	860.64	✓
CN027	550	1202	90	17	1226 / 4183	5287	863.50	1036.20	✓
CN027	1800	229	90	3	922 / 3146	3976	386.10	463.32	✓
CN027	1800	370	90	5	1538 / 5248	6633	572.00	686.40	✓
CN027	1800	507	90	7	2153 / 7346	9285	754.60	905.52	✓



Mode

Wall or Floor Mounted



Mode suits traditional properties, yet also looks great in contemporary settings.

Available in a wide range of sizes, so you can choose a radiator which exactly suits your space and required heat output. The standard colour finish is white RAL 9016. Other RAL colours are available. Please see page 162 for other colour options. Subject to manufacturing tolerances.

Please note, contemporary colours available on 2, 3 & 4 column only.

Wall brackets are included, feet and other fixing accessories are detailed on the next pages. For valve options see page 160.

Standard Stock Sizes (opposite)

We stock 2, 3 and 4 column radiators. Heights range from 300mm great for under window sills, to a 1800mm tall version. There are many sizes in between.

Non Standard Sizes (next pages)

Non standard sizes include 5 and 6 columns ranging from 300mm - 2000mm high and detailed on the next pages. Non stocked and colour finish options have an eight week lead time.



VL004 Arne Thermostatic option



VL008

For valve options see page 160

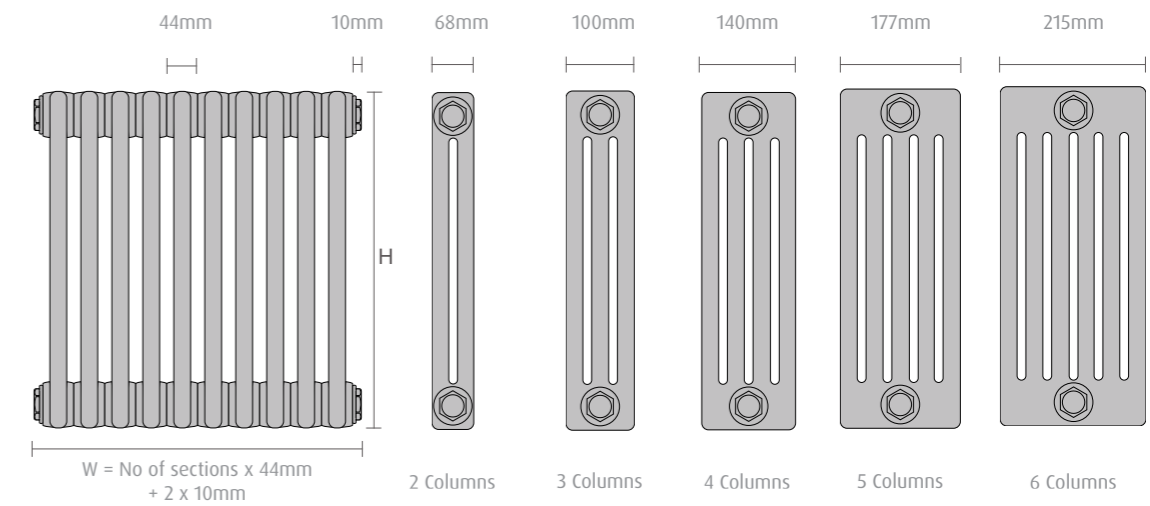

Mode

	Dimensions (mm)			Number of Sections	Output ΔT 50°C Watts/BTU's	Output ΔT 60°C BTU's	Price (ex VAT) White	Price (inc VAT) White	Stock or made to order
	H	W	D						
2 Column Radiators									
2C-050-10	500	460	68	10	371 / 1266	1600	309.10	370.92	✓
2C-050-18	500	812	68	18	688 / 2347	2967	478.50	574.20	✓
2C-050-22	500	988	68	22	817 / 2788	3524	565.40	678.48	✓
2C-060-10	600	460	68	10	440 / 1501	1898	321.20	385.44	✓
2C-060-14	600	636	68	14	616 / 2102	2657	409.20	491.04	✓
2C-060-18	600	812	68	18	792 / 2702	3416	493.90	592.68	✓
2C-060-22	600	988	68	22	968 / 3303	4175	579.70	695.64	✓
2C-060-24	600	1076	68	24	1056 / 3603	4554	631.40	757.68	✓
2C-060-28	600	1252	68	28	1232 / 4204	5313	719.40	863.28	✓
2C-180-6	1800	284	68	6	774 / 2641	3338	371.80	446.16	✓
2C-180-8	1800	372	68	8	1032 / 3521	4451	477.40	572.88	✓
2C-180-10	1800	460	68	10	1290 / 4401	5563	546.70	656.04	✓
2C-180-12	1800	548	68	12	1548 / 5282	6676	635.80	762.96	✓
3 Column Radiators									
3C-050-14	500	636	100	14	720 / 2457	3105	477.40	572.88	✓
3C-050-18	500	812	100	18	926 / 3160	3994	575.30	690.36	✓
3C-050-22	500	988	100	22	1131 / 3859	4878	677.60	813.12	✓
3C-050-24	500	1076	100	24	1234 / 4210	5322	732.60	879.12	✓
3C-050-28	500	1252	100	28	1440 / 4913	6210	838.20	1005.84	✓
3C-060-10	600	460	100	10	609 / 2078	2626	391.60	469.92	✓
3C-060-14	600	636	100	14	852 / 2907	3674	497.20	596.64	✓
3C-060-18	600	812	100	18	1097 / 3743	4731	605.00	726.00	✓
3C-060-20	600	900	100	20	1218 / 4156	5253	660.00	792.00	✓
3C-060-24	600	1076	100	24	1462 / 4988	6305	768.90	922.68	✓
3C-060-30	600	1340	100	30	1827 / 6234	7879	932.80	1119.36	✓
3C-075-10	750	460	100	10	750 / 2559	3235	441.10	529.32	✓
3C-075-14	750	636	100	14	1050 / 3583	4528	565.40	678.48	✓
3C-075-18	750	812	100	18	1350 / 4606	5822	690.80	828.96	✓
3C-075-22	750	988	100	22	1650 / 5630	7116	814.00	976.80	✓
3C-075-26	750	1164	100	26	1950 / 6653	8410	948.20	1137.84	✓
3C-180-8	1800	372	100	8	1412 / 4818	6090	559.90	671.88	✓
3C-180-10	1800	460	100	10	1764 / 6019	7608	662.20	794.64	✓
3C-180-12	1800	548	100	12	2117 / 7223	9130	765.60	918.72	✓
4 Column Radiators									
4C-030-20	300	900	140	20	850 / 2900	3666	1117.60	1341.12	✓
4C-030-30	300	1340	140	30	1275 / 4350	5499	1676.40	2011.68	✓
4C-060-14	600	636	140	14	1147 / 3914	4947	635.80	762.96	✓
4C-060-18	600	812	140	18	1475 / 5033	6361	745.80	894.96	✓
4C-060-20	600	900	140	20	1638 / 5589	7064	814.00	976.80	✓
4C-060-24	600	1076	140	24	1966 / 6708	8479	963.60	1156.32	✓
4C-075-14	750	636	140	14	1417 / 4835	6111	700.70	840.84	✓
4C-075-18	750	812	140	18	1822 / 6217	7858	874.50	1049.40	✓
4C-075-22	750	988	140	22	2227 / 7599	9605	1047.20	1256.64	✓
4C-075-26	750	1164	140	26	2632 / 8980	11351	1223.20	1467.84	✓

Mode







Bespoke



This service gives the opportunity to order non standard sizes. Choose from wall or floor standing. These radiators are supplied in white RAL 9016. Coloured finishes are available, please see page 162 for colour options. Please note, contemporary colours available on 2, 3 & 4 column only. The lead time for delivery is approximately eight weeks. The sections cannot be joined on site. We only supply complete radiators, practical considerations need to be given to weight, carriage, handling and accessibility. Where necessary large radiators can be supplied in module format. Contact our sales office for further information.



VL003 For valve options see page 160

Accessories for Mode Column Radiators	Price (ex VAT)	Price (inc VAT)	Stock or made to order	Calculations for Sizing a Radiator
 Column Radiator Feet AC028	90.00 per pair	108.40 per pair	✓	<p>Required output is 1200 watts Space available is 1000 mm high x 750 mm wide. Approx radiator dimensions 900mm high x 600mm wide. (Taking into account space for valves)</p> <p>Number of sections possible Width (600mm) divide by 45mm per section + allowance for each side. 600 - 24 divided by 45 = 12 sections.</p> <p>Heat output per section Divide your required output by sections. 1200 watts divided by 12 = 100 watts per section.</p> <p>Selecting your radiator section 4-750 @102 watts per section. Therefore 12 sections @102 per section = 1224 watts @ 50 degrees C delta T.</p> <p>Price calculation 12 x 43.00 =516.00 ex VAT, Plus feet if floor standing and any other non standard support brackets you may require.</p> <p>Dimensions The nominal overall length of a radiator =number of section x 45mm = 24mm for reducing bushes (12mm each end). Subject to manufacturing tolerance of +/- 0.7mm (1.5%) per section.</p>
 Adjustable Feet AC024 Height from 90mm to 120mm. Must only be used with top retaining stay.	56.00 each	67.20 each	✓	
 Base Plate Cover AC025 For use with adjustable feet (above).	13.00 each	15.60 each	✓	
 Top Retaining Stay AC026 For use with adjustable feet.	20.00 each	24.00 each	✓	
 Standing Brackets For use with glass walls etc...	POA	POA	✘	
 Welded Feet - 2 Heights Available (75mm or 140mm) Up to 20 sections requires two feet 21 to 40 sections three feet 41 to 58 sections four feet	90.00 each	108.40 each	✘	



Mode Sections	Dimensions (mm)		Output ΔT 50°C Watts/BTU's	Output ΔT 60°C BTU's	Price (ex VAT) White	Price (inc VAT) White	Stock or made to order
	H	D					
2 Column Section							
2-300	300	65	24 / 82	104	35.31	42.37	✘
2-400	400	65	31 / 106	134	35.31	42.37	✘
2-500	500	65	37 / 126	160	35.31	42.37	✘
2-600	600	65	44 / 150	190	36.38	43.66	✘
2-750	750	65	55 / 188	238	36.38	43.66	✘
2-900	900	65	65 / 222	282	39.59	47.51	✘
2-1000	1000	65	72 / 246	312	42.80	51.36	✘
2-1200	1200	65	86 / 293	372	54.57	65.48	✘
2-1500	1500	65	108 / 369	468	68.48	82.18	✘
2-1800	1800	65	129 / 440	558	80.25	96.30	✘
2-2000	2000	65	144 / 491	623	103.79	124.55	✘
3 Column Section							
3-300	300	105	33 / 113	143	42.80	51.36	✘
3-400	400	105	42 / 143	181	40.66	48.79	✘
3-500	500	105	52 / 177	224	39.59	47.51	✘
3-600	600	105	61 / 208	264	40.66	48.79	✘
3-750	750	105	75 / 256	325	47.08	56.50	✘
3-900	900	105	90 / 307	389	53.50	64.20	✘
3-1000	1000	105	99 / 338	429	55.64	66.77	✘
3-1200	1200	105	118 / 403	511	71.69	86.03	✘
3-1500	1500	105	147 / 502	637	88.81	106.57	✘
3-1800	1800	105	177 / 604	766	104.86	125.83	✘
3-2000	2000	105	197 / 672	852	118.77	142.52	✘
4 Column Section							
4-300	300	145	43 / 147	186	47.08	56.50	✘
4-400	400	145	56 / 191	242	48.15	57.78	✘
4-500	500	145	69 / 235	298	49.22	59.06	✘
4-600	600	145	82 / 280	355	50.29	60.35	✘
4-750	750	145	102 / 348	441	50.29	60.35	✘
4-900	900	145	121 / 413	524	54.57	65.48	✘
4-1000	1000	145	134 / 457	579	63.13	75.76	✘
4-1200	1200	145	159 / 543	689	83.46	100.15	✘
4-1500	1500	145	197 / 672	852	110.21	132.25	✘
4-1800	1800	145	235 / 802	1017	132.68	159.22	✘
4-2000	2000	145	260 / 887	1125	147.66	177.19	✘
5 Column Section							
5-300	300	185	52 / 177	224	53.50	64.20	✘
5-400	400	185	68 / 232	294	54.57	65.48	✘
5-500	500	185	83 / 283	359	56.71	68.05	✘
5-600	600	185	98 / 334	424	59.92	71.90	✘
5-750	750	185	121 / 413	524	66.34	79.61	✘
5-900	900	185	143 / 488	619	73.83	88.60	✘
5-1000	1000	185	158 / 539	683	80.25	96.30	✘
5-1200	1200	185	188 / 641	813	102.72	123.26	✘
5-1500	1500	185	232 / 792	1004	134.82	161.78	✘
5-1800	1800	185	277 / 945	1198	160.50	192.60	✘
5-2000	2000	185	307 / 1048	1329	176.55	211.86	✘
6 Column Section							
6-300	300	225	63 / 215	273	63.13	75.76	✘
6-400	400	225	82 / 280	355	64.20	77.04	✘
6-500	500	225	101 / 345	437	66.34	79.61	✘
6-600	600	225	120 / 409	519	70.62	84.74	✘
6-750	750	225	148 / 505	640	80.25	96.30	✘
6-900	900	225	175 / 597	757	92.02	110.42	✘
6-1000	1000	225	193 / 659	836	99.51	119.41	✘
6-1200	1200	225	229 / 781	990	129.47	155.36	✘
6-1500	1500	225	282 / 962	1220	162.64	195.17	✘
6-1800	1800	225	334 / 1140	1446	193.67	232.40	✘
6-2000	2000	225	369 / 1259	1596	211.86	254.23	✘

Eco Modular Bars

Wall Mounted ELTB12V

Eco modular bars are available in polished stainless steel or matt black in two widths. The bars are powered by SELV (Safety Extra Low Voltage) 12v connection and can be singular or linked to create multiple heated bars.



Electric

Designed to work in places where it's just not practical for your central heating system to go, our electric range is a stylish solution for any space. Plus they have all our hallmark design and quality craftsmanship.



Also available in matt black finish



Round bar with mitred corner



Square bar with mitred corner

Modular Bars

Tube diameter Ø □	Dimensions (mm)			Electric Element Wattage	Price (ex VAT) Matt Black	Price (inc VAT) Matt Black	Price (ex VAT) Polished	Price (inc VAT) Polished	Stock or made to order
	32mm	40 x 25mm							
ELTB12V ROUND	32 Ø	500	100	10.3 W	144.00	172.80	140.00	168.00	✓
ELTB12V ROUND	32 Ø	600	100	13.0 W	156.00	187.20	151.00	181.20	✓
ELTB12V SQUARE	40	500	100	10.3 W	171.00	205.20	166.00	199.20	✓
ELTB12V SQUARE	40	600	100	13.0 W	180.00	216.00	174.00	208.80	✓

Supplied with connections and 6m cable as standard. A 12v transformer is priced at 32.00 (ex VAT) 38.40 (inc VAT).

Comfort

Wall Mounted EL028

Comfort is ideal for compact situations. It is electric only and is manufactured in high quality mild steel, chromed to a mirror finish. Electrical components are covered by our two year warranty. Has a rating of IP55.



Detail shot to show angled bars

MS E

Comfort

	Dimensions (mm)			Power wattage	Price (ex VAT) Chrome	Price (inc VAT) Chrome	Stock or made to order
	H	W	D				
EL028	675	545	95	120	327.00	392.40	✓

Simplicity II

Wall Mounted EL040 / EL045

Uncomplicated and chic. The linear styling of Simplicity adds a sense of sophistication to any room. Slimline and discreet it provides the comfort of warm fluffy towels or bathrobes. This is electric drylined only.



Manufactured in high quality stainless steel. Electrical components are covered by our two year warranty. IP44 when installed as per installation instructions. Delivered complete, no cover shroud necessary.

SS DL

Simplicity II

	Dimensions (mm)		Description	Power W	Price (ex VAT) Polished	Price (inc VAT) Polished	Stock or made to order
	H	D					
EL040 Round	1100		Round tube 30mm Ø	28-30	317.00	380.40	✓
EL040 Round	1500		Round tube 30mm Ø	42-44	346.00	415.20	✓
EL040 Round	1800		Round tube 30mm Ø	52-55	403.00	483.60	✓
EL045 Cube	1100		Square tube 30 x 30mm	33-35	395.00	474.00	✓
EL045 Cube	1500		Square tube 30 x 30mm	49-52	435.00	522.00	✓
EL045 Cube	1800		Square tube 30 x 30mm	64-68	491.00	589.20	✓



Electric

Underfloor Heating

There is nothing that quite matches the comfort of warm feet when getting out of the bath or shower, especially in the cold winter months! Imagine stepping onto warm tiles controlled to the temperature you prefer.

Electric underfloor heating works by gently warming the mass of floor which in turn warms the rest of the room. Our underfloor heating kit is quick and easy to install. Ideally timed when you are fitting a new kitchen or bathroom. Electrical components are covered by a two year warranty.

The Underfloor Heating Kit Includes

- The correct size heating mat.
- Digital touch screen timer and thermostat.
- Floor sensor and floor sensor mounting pipe.
- Multimeter to check installation at every stage.
- Comprehensive installation manual and control card.

Putting You in Control...

The digital touch screen, completely programmable timer and thermostatic controller enables you to fully regulate the temperature and control when the heating is on or off. The manual override means at the touch of a button the temperature can be higher or lower to suit as and when it is needed.



E

EU FH

	Area Metre(s)	Rated Power Wattage per mat	Price (ex VAT)	Price (inc VAT)	Stock or made to order
EU FH150-01.0	1.0	150	200.20	240.24	✓
EU FH150-01.5	1.5	225	222.20	266.64	✓
EU FH150-02.0	2.0	300	237.60	285.12	✓
EU FH150-02.5	2.5	375	254.10	304.92	✓
EU FH150-03.0	3.0	450	273.90	328.68	✓
EU FH150-03.5	3.5	525	291.50	349.80	✓
EU FH150-04.0	4.0	600	309.10	370.92	✓
EU FH150-04.5	4.5	675	364.10	436.92	✓
EU FH150-05.0	5.0	750	378.40	454.08	✓
EU FH150-06.0	6.0	900	409.20	491.04	✓
EU FH150-07.0	7.0	1050	448.80	538.56	✓
EU FH150-08.0	8.0	1200	488.40	586.08	✓
EU FH150-09.0	9.0	1350	531.30	637.56	✓
EU FH150-10.0	10.0	1500	565.40	678.48	✓
EU FH150-12.0	12.0	1800	645.70	774.84	✓



SILENT Design 100

- Silent elastic blocks
- Sealed for life ball bearings
- Back draught shutter and airflow guide vanes
- High performance and quality
- Incredibly silent running
- Energy efficient
- 8 Watts / 230 Volts
- IP45 rated



A range of 100mm domestic axial extract fans for wall or ceiling installations, designed to solve ventilation problems in WC's and bathrooms. Fitted with motors mounted on silent elastic blocks, the fans deliver incredibly silent running and exceptional performance and stylish design.

ECO dMEV

- Up to 6 adjustable trickle speed settings
- Timer, humidity sensor and pull cord models
- Complies with Building Regulations. Part F for system 3 Continuous Mechanical Extract
- SAP Appendix Q eligible achieving a low specific fan power of 0.28 W/l/s
- Incredibly silent running - Below 20 dB(A)
- One fan for all situations, both walls and ceilings
- Low Energy DC 1.5 Watts - Low voltage version available
- 4 Interchangeable front panel trims



The ECO dMEV has been designed and developed to offer the market a constant volume, continuously running, decentralised extract fan for the lowest power consumption, the lowest noise and lowest lifecycle costs.

SILENT MV

- Sound absorbent insulation
- Incredibly silent running
- 360° rotating connection box
- Sealed for life ball bearings
- Fitted with a two speed motor
- Complies with building regulations
- High performance with flexible location
- Easy installation and maintenance
- IP44 rated



The SILENT MV fan range offers one of the most versatile fan systems on the market today. Due to its flexibility it can be used in a multitude of small and medium fan installations. Especially advantageous in applications where the system may be running for long periods throughout the day, the acoustic benefits of the SILENT MV fans ensure that optimum comfort is achieved without the disturbance of noisy ventilation systems.

SILENT 100

- Also available in silver on silent elastic blocks
- Sealed for life ball bearings
- Back draught shutter and airflow guide vanes
- High performance and quality
- Incredibly silent running
- Significant energy savings
- 8 Watts / 230 Volts or 13 Watts / 12 Volts options
- IP45 / IP57 SELV version



100mm domestic axial extract fans for wall or ceiling installations. Designed to solve ventilation problems in WC's and bathrooms. Fitted to motors mounted on silent elastic blocks, fans are incredibly silent running and exceptional performance.

Optional Kits



Fan	Description	Airflow rates - l/s (m ³ /h)	Price (ex VAT)	Price (inc VAT)	Stock or made to order
Silent Design 100					
SILDES100 S	White Standard	22 (85)	114.00	136.80	✓
SILDES100 SS	Silver Standard	22 (85)	137.00	164.40	✓
SILDES100 T	White Timer	22 (85)	143.00	171.60	✓
SILDES100 TS	Silver Timer	22 (85)	190.00	228.00	✓
SILDES100 HT	White Adjustable Humidity Sensor	22 (85)	184.00	220.80	✓
SILDES100 HTS	Silver Adjustable Humidity Sensor	22 (85)	245.00	294.00	✓
Eco dMEV					
Eco dMEV S	Standard	18 (65)	382.50	459.00	✓
Eco dMEV T	Adjustable Run-On Timer	18 (65)	423.00	507.60	✘
Eco dMEV HT	Adjustable Humidity Sensor & Timer	18 (65)	487.00	584.40	✘
Eco dMEV HTP	Pull Cord Adjustable Humidity Sensor & Timer	18 (65)	490.00	588.00	✘
Eco dMEV S SELV	Standard (SELV)	18 (65)	543.00	651.60	✘
Eco dMEV T SELV	Adjustable (SELV) Run-On Timer	18 (65)	580.00	696.00	✘
Eco dMEV HT SELV	Adjustable (SELV) Humidity Sensor & Timer	18 (65)	714.00	856.80	✓
Eco dMEV HTP SELV	Pull Cord Adjustable (SELV) Humidity Sensor & Timer	18 (65)	715.00	858.00	✓
Silent MV					
SILMV 160100 S	Silent 2 speed in line fan	50 (80)	166.00	199.20	✓
SILMV 160100 T	Silent single speed inline fan with adjustable timer	50 (80)	188.00	225.60	✓
SILMV 250100 S	Silent 2 speed in line fan	50 (80)	463.00	555.60	✘
SILMV 250100 T	Silent single speed inline fan with adjustable timer	50 (80)	444.00	532.80	✘
Silent 100					
Silent-100 S	Standard	26 (95)	95.00	109.20	✓
Silent-100 T	Adjustable Timer	26 (95)	132.00	130.80	✓
Silent-100 HT	Adjustable Humidity Sensor	26 (95)	205.00	246.00	✓
Silent-100 PIR	PIR	26 (95)	244.00	292.80	✘
Silent-100 SS SILVER	Silver Standard	26 (95)	107.00	128.40	✓
Silent-100 ST SILVER	Silver Adjustable Timer	26 (95)	147.00	176.40	✓
Optional Kits					
ENV-WALL KIT	Wall Grill & pipe		32.00	38.40	✓
ENV-CEILING KIT	Ceiling Vent, 6M Flex & 2 flex ties		30.00	36.00	✓
ENV-SOFIT KIT	Wall grill, 3M Flex & 2 flex ties		37.00	44.40	✓
ENV-3M FLEX	3 metre flex 100 dia		33.00	39.60	✓
ENV-6M FLEX	6 metre flex 100 dia		58.00	69.60	✓

Electrical components are covered by a two year warranty. Other fans and accessories are available on request.



Additions

For the perfect finishing touch, enhance and complement your towel rail or radiator with our collection of high quality accessories and additions. From timers to aroma oil dishes, the choice is all yours.

Electric Element Only Prices

Heating Options



Standard Element

IP55 Suitable for zones 1 and 2 of the bathroom.

Each standard element contains a preset surface temperature control along with a back up fail safe, this is the only temperature control supplied, for more flexibility over the surface temperature we recommend using our AC012 (rheostat), this will give you surface temperature modulation, when fitted into the electrical supply circuit.

Available as a summer kit for dual fuel options. See page 156 for tee piece AC003 £39.00 ex VAT, £46.80 inc VAT

Element Cable Length 1.5 MTR

Product	Watts	Price (ex VAT)	Price (inc VAT)
EE002	50w	61.00	73.20
EE002	75w	64.00	76.80
EE002	100w	101.00	121.20
EE002	125w	103.00	123.60
EE002	150w	104.00	124.80
EE002	200w	106.00	127.20
EE002	300w	107.00	128.40
EE002	400w	108.00	129.60
EE002	600w	113.00	135.60



Heat Sensor Element

PX5 suitable for zones 1 and 2 of the bathroom.

Five temperature settings ranging from 30°C to 60°C. The device displays the temperature to which it is currently set and indicates the status of the heating cycle.

Optional accessory - Heat Sensor Element Cover Shroud AC040, to hide the cable - £18.00 ex VAT, £21.60 inc VAT. See page 156.

Can be used when depth from wall to centre is the max of 70mm.

Element Cable Length 1.5 MTR

Product	Watts	Price (ex VAT)	Price (inc VAT)
EE006	200w	182.00	218.40
EE006	300w	193.00	231.60
EE006	400w	201.00	241.20
EE006	600w	212.00	254.40
EE006	800w	221.00	265.20
EE006	1000w	234.00	280.80



Electronique Element

IP66 Suitable for zones 1 and 2 of the bathroom.

The standard Electronique element is set to a constant surface temperature of 52°C, with no need for external controls. In the fully loaded towel warming mode it will act to reduce power and save running costs. In space heating mode it will increase the power to deliver background heat needed to the maximum of its rated capacity. A safe to touch system, with safety measures incorporated.



Available as a summer kit for dual fuel options. See page 156 for tee piece AC003 £39.00 ex VAT, £46.80 inc VAT

Element Cable Length 1 MTR

Product	Watts	Price (ex VAT)	Price (inc VAT)
EE001A	200w	235.00	282.00
EE001A	400w	246.00	295.20
EE001A	600w	263.00	315.60



Remote or In-App Controlled Heat Element

IPX4 suitable for zones 1 and 2 of the bathroom. Negative Temperature Coefficient technology. 7 day programmable element with remote control or in-app control switches the towel rail on and off when you want, at the temperature you want. Eco, boost and safety lock features included, and manual override allows you total flexibility when needed. Can be retro fitted to existing electric or dual fuel multirail towel warmers. Remote control sold separately.



*Please note, Element only suitable for vertical installation



Available as a summer kit for dual fuel options. See page 156 for tee piece AC003 £39.00 ex VAT, £46.80 inc VAT

Element Cable Length 1.4 MTR

Product	Watts	Price In-App (ex VAT)	Price In-App (inc VAT)
EE005	300w	223.00	267.60
EE005	600w	226.00	271.20
RC (Remote control only)		66.00	79.20



Contract Fixed Heat / LST Electronique Element

IP55 Suitable for zones 1 and 2 of the bathroom.

Fixed Heat is designed as an energy saving element to control temperature and consume only the correct amount of power required. It maintains your pre-set temperature whether the rail is in a cold bathroom empty or fully loaded with towels. Fixed Heat for LST (low surface temperature) of 43°C must be chosen to comply with LST legislation for use in public buildings, hospitals and care homes.

Element Cable Length 1 MTR

Product	Watts	Price (ex VAT)	Price (inc VAT)
EE001C	200w	235.00	282.00
EE001C	400w	246.00	295.20
EE001C	600w	263.00	315.60



Standard Rail Option (H) and (C)



Multirail Option (H) and (C)

Heating Only Options



Is suitable for all heating and hot water systems. For connection to either direct (open) or indirect (closed) central heating systems.



Suitable for indirect (closed) central heating circuits only. It cannot be installed on an open circuit due to the product containing ferrous (steel) parts.



Standard Rail Option (E)



Multirail Option (E)

Electric Only Options



A completely independent unit requiring only a fused spur electric connection. Thermal transfer fluid is heated by an electric element within the towel rail.



Standard Rail Option (D)



Multirail Option (D)

Dual Fuel Options



The towel rail has the capability to run from a central heating circuit or an electric element. Handy in the summer months when the central heating is turned off.



Internal view



Rear external view

Electric Dryline Option



Electric dryline technology, with the towel warmer not containing any fluids. The towel warmer is heated using a silicone heater cable, exiting the towel warmer via a three core cable. This can then be attached to a fuse spur. Only available on specific models, please contact our sales office on +44(0)1902 387000 for further details. POA.

Please Note:

When using the electric element only (i.e., during summer), allowance must be made for thermal expansion within the product by having the 'return' radiator valve left partially open. The 'flow' radiator valve must be closed to prevent back flow through the system. Both valves should be opened and balanced when the central heating system is operative, (i.e. during winter). Steel Rails - Must be installed in accordance with BS7593 where a corrosion inhibitor is used.

Brass Rails - Caution where water softener is installed, as this could cause dezincification (material is attacked i.e. zinc eaten away by aggressive water).

Brass towel warmers are manufactured using dezincification resistant brass, however it should be understood that the term 'resistant' does not entirely preclude the possibility of dezincification occurring. If you intend to install the product on an open (DHW) circuit, make reference to your local water authority to ensure dezincification has not previously occurred. Towel warmers manufactured from brass tubing should not be installed on an open circuit if a water softener is present. Water analysis to determine the likelihood of dezincification is available at cost. Models suitable for indirect (closed) circuits only cannot be installed on an open circuit due to the item containing ferrous (steel) parts. Product compatibility is the responsibility of the installer.

Fitted Electric & Dual Fuel Prices

This section contains a range of elements with price supplements for electric and dual fuel models. Please add the price of your element to the model you choose and we will build it for you.



Standard Element IP55 Code EE002
A benchmark element to suit each size of product.

- £ Electric Only £201.00 ex VAT, £241.20 inc VAT
- Ⓧ Dual Fuel £138.00* ex VAT, £165.60 inc VAT



Electronique Element IP66 Code EE001A
Maintains surface temperature of product to 52 °C.

- £ Electric Only £314.00 ex VAT, £376.80 inc VAT
- Ⓧ Dual Fuel £259.00* ex VAT, £310.80 inc VAT



Heat Sensor Element IPX5 Code EE006
An electronic temperature sensor control.

- £ Electric Only £296.00 ex VAT, £355.20 inc VAT
- Ⓧ Dual Fuel £244.00* ex VAT, £292.80 inc VAT

Optional cover shroud available AC040 - £18.00 ex VAT
£21.60 inc VAT, See page 156



Remote or In-App Controlled Heat Element IPX4 Code EE005
NTC - Negative Temperature Coefficient technology. Controlled by an app on a phone / tablet or remote controlled.

- £ Electric Only £331.00 ex VAT, £397.20 inc VAT
 - Ⓧ Dual Fuel £269.00* ex VAT, £322.80 inc VAT
- Remote Control £66.00 ex VAT, £79.20 inc VAT



Fixed Heat / LST Electronique Element IP55 Code EE001C
Ideal for LST applications where surface temperatures need to be guaranteed.

- £ Electric Only £314.00 ex VAT, £376.80 inc VAT

* Dual fuel models will also be supplied with a conversion tee where applicable. This can be used with VL013 valves for a multitrail. Alternatively, to a conversion tee dual fuel valves VL015 can be used. All the images of elements depict electric only versions. Dual fuel configurations may vary including element positioning. The appropriate standard versions will be supplied in all cases unless advised otherwise. Electric towel warmers are filled with a glycol ethylene / water mix to strict guidelines. This improves the thermal transfer rate and acts as a corrosion inhibitor. All electric and dual fuel towel warmers must be fitted by a qualified person. The elements are fitted on the right hand side as standard. They can be left hand mounted on request, on certain rails only. Dual Energy units are supplied with matching tee pieces wherever possible. Please consult with Sales to confirm suitability and pricing for your own requirements.

IP Rating and Bathroom Zones

This section contains information on electrical safety. IEE Wiring Regulations have identified the following zones and IP ratings to ensure safety.



IP Zoning

ZONE 0	Inside the bath or shower. Any fitting here must be SELV (max 12v) and a minimum rating of IPX7. (Protection against immersion in water).
ZONE 1	Above the bath or shower to a height of 2.25m. A minimum rating of IPX4 is required * See note 1.
ZONE 2	The area stretching to 0.6m outside the bath or shower and above the bath or shower if over 2.25m. A minimum rating of IPX4 is required * See note 1.
OUTSIDE ZONES	Anywhere outside zones 0, 1, and 2. Where water jets are not used for cleaning purposes, the general rules BS7671 apply. * See note 1.

All final circuits require 30mA RCD protection.

- In zones 1 and 2 if there is a likelihood of water jets being used for cleaning purposes a minimum of IPx5 is required.
- Where ceiling heights exceed 2.25m, the zones are effectively up to 3m, beyond 3m the walls are out of scope.
- Basins are not covered, however they are usually considered zone 2.
- If the space underneath a bath cannot be accessed without tools that space is considered out of zone.
- Information contained on this page is for guidance only. Please refer to current IEE Regulations or a qualified electrician.

IP Rating Guide

The IP (ingress protection) rating given to an enclosure, states the degree of protection it offers by means of two digits. A summary of these are detailed below. For more information please see British BS EN 60529:1992, European IEC 60509:1989

First Digit

Protection against solid foreign objects and access to hazardous parts.

At the lowest of seven levels is 0, this means no protection is offered. At the highest level 6, there shall be no entry of dust particles.

Second Digit

Protection against entrance of water on a progressive scale. At level 1 dripping water shall have no effect. at level 6 water from powerful jets against the enclosure shall have no effect.

The letter X can be used in place of the first digit or second digit to indicate that tests have not been carried out or are not applicable.

0		No protection.	0		No protection.
1		Protected against solid objects larger than 50mm e.g. accidental touch by hands.	1		Protected against vertically falling drops of water e.g. condensation.
2		Protected against solid objects larger than 12.5mm e.g. fingers.	2		Protected against direct sprays of water up to 15° from the vertical.
3		Protected against solid objects larger than 2.5mm e.g. tools and cables.	3		Protected against direct sprays of water up to 60° from the vertical.
4		Protected against solid objects larger than 1mm.	4		Protected against water splashed from all directions - limited ingress permitted.
5		Protected against dust (no harmful deposits).	5		Protected against low pressure jets of water from all directions - limited ingress permitted.
6		Totally protected against dust.	6		Protected against strong jets of water e.g. for use on ship decks - limited ingress permitted.
			7		Protected against the effects of temporary immersion in water between 150mm and 1m.
			8		Protected against continuous submersion at a specified depth.

IEC 529, bs en 60529 does not apply to any risk of explosion or conditions such as humidity, corrosive gases, fungi or vermin. In certain cases equipment designed to be mounted in an enclosure will contribute towards the stated IP rating (eg Push buttons mounted in an enclosure). Different parts of enclosures can have different degrees of protection and still conform to the standard (e.g. Enclosures with pre-drilled conduit entry). All information strictly for guidance only, please refer to regulations and manufacturers for information if you are in any doubt.

Accessories



AC002
Ball vent



AC003
Conversion tee for dual energy radiators
Also available in Matt Black and Anthracite



AC004
Valve sleeves Chrome



AC005
Valve sleeves White,
Anthracite or Matt Black



AC005
Connection tubes



AC006
Street elbow
connection tubes



AC031
Clip on frosted sphere
and chrome robe hook



AC035
Blanking Plug with Aroma Oil Dish



AC040
Heat Sensor Element Cover Shroud
Can be used when depth from wall to centre
is the maximum of 70mm

AC007
Electric element shroud covers. Shown as standard in chrome. Other
finishes are available, please contact the sales office for a quote.



*Please be aware that some cover shrouds conceal the element block and cable but NOT the service nut. If unsure, please ask your Dealer for more information prior to ordering.



AC060
Air vent cap



AC065
Universal chrome robe hook

Product	Description	Price (ex VAT) Chrome	Price (inc VAT) Chrome	Stock or made to order
AC002	1/2" BSP M.I. Decorative air vent and plug	107.00	128.40	✓
AC003	Three point 1/2" BSP adaptor. For electric element and radiator valve link	39.00	46.80	✓
AC004	19 mm ø x 100 mm long, electroplated to match towel rail and valves	89.00	106.80	✓
AC005CAT	15 mm ø x 180 mm long, Anthracite to match towel rail and valves	24.00	28.80	✓
AC005CMB	15 mm ø x 180 mm long, Matt Black to match towel rail and valves	24.00	28.80	✓
AC005CWH	15 mm ø x 180 mm long, White to match towel rail and valves	24.00	28.80	✓
AC005	15 mm ø x 150 mm long	39.00	46.80	✓
AC005	22 mm ø x 150 mm long	51.00	61.20	✓
AC006	15 mm ø x 150 mm long	56.00	67.20	✓
AC007A	Legacy ball joint	137.00	164.40	✓
AC007B	Contemporary	121.00	145.20	✓
AC007C	Mitred	121.00	145.20	✓
AC007D	Flexi (suitable for use with standard element only)	139.00	166.80	✓
AC007E	Preset (suitable for use with EE001c, EE005 & EE006)	121.00	145.20	✓
AC007F	Originals ball joint	157.00	188.40	✓
AC007G	Electronique (suitable for use with electronique element only)	121.00	145.20	✓
AC007H	Hexagonal	185.00	222.00	✓
AC035	Oil Aroma Blanking Plug	12.00	14.40	✓
AC040	Heat Sensor Element Cover Shroud	18.00	21.60	✓
AC031	Chrome and frosted sphere. Suitable for MD001, MD003, MD005 and MD034	52.00	62.40	✓
AC060	Air vent cap (per pair) to fit over radiator vent & blanking plug	9.00	10.80	✓
AC065	Universal Chrome robe hook. Suitable for MD062, MD063, MD001, MD002, MD006, MD003, MD004, MD034	16.00	19.20	✓

AC012 Voltage Regulator
A manual controller to manage power
consumption to your towel warmer



AC013 7 Day Timer
Control the time of day the towel rail on



AC014 Pattress Plate
Housing the wires from the towel rail
element if no external controller is required



AC010
Round or square metal cover plates



AC011
Arne straight or angled fixing kit



AC011F
Crosshead angled fixing kit



AC011S
Piazza angled fixing kit

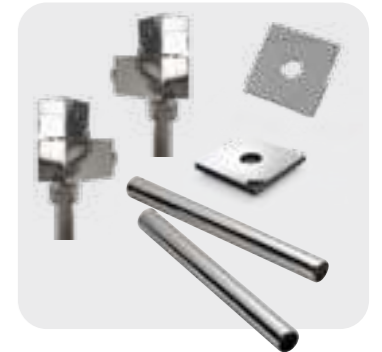

AC011A & AC011B ARE AVAILABLE IN OUR CONTEMPORARY COLOUR FINISHES POA.

Product	Description	Price (ex VAT) Chrome	Price (inc VAT) Chrome	Stock or made to order
AC010A	Round 15 mm internal diameter hinged cover plates	25.00	30.00	✓
AC010B	Square 15 mm internal diameter cover plates	25.00	30.00	✓
AC011A & AC011B	VL003 (pair) straight or angled valves with cover plates and connection tubes	111.00	133.20	✓
AC011F	VL008 (pair) angled valves with cover plates and connection tubes	137.00	164.40	✓
AC011S	VL0014 (pair) angled valves with cover plates and connection tubes	155.00	186.00	✓
AC012	Chrome 75W - 400W (1 gang)	69.00	82.80	✓
AC012	Chrome 150W - 1000W (2 gang)	143.00	171.60	✓
AC013	Digital single channel programme timer	73.00	87.60	✓
AC014	Covers 1 gang pattress box (Chrome)	38.00	45.60	✓

Accessories

Available left or right handed to suit, Universal towel rail shelves are available in 3 sizes with a choice of white or anthracite finish. Easy to install with a simple 3 step fix to the wall.



AC067
 Universal towel rail shelves in 3 widths
 Left or right handed in a choice of white or anthracite finish

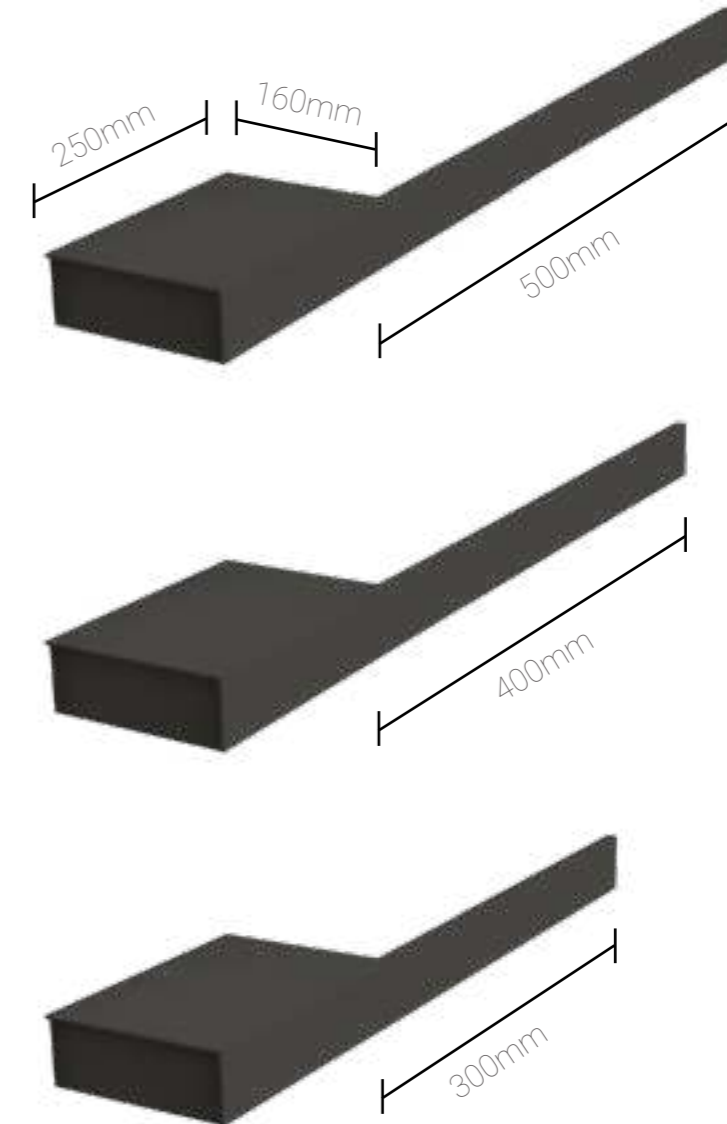

Product	Description	Price	Price	Stock or made to order
		(ex VAT) White / Anthracite	(inc VAT) White / Anthracite	
AC067	300mm Universal towel rail shelf (550mm width with shelf) left or right handed	108.00	129.60	✓
AC067	400mm Universal towel rail shelf (650mm width with shelf) left or right handed	110.00	132.00	✓
AC067	500mm Universal towel rail shelf (750mm width with shelf) left or right handed	112.00	134.40	✓

Valves



Arne VL003
See below for finishes



Arne Thermostatic VL004
Thermostatically controlled



Arne Thermostatic VL004
Straight or angled matt black or anthracite



Arne Thermostatic VL004
Straight or angled PVD brushed brass



Art Deco VL006
Great for hexagonal tube deco designs



Crosshead VL008
Suits most traditional designs



Crosshead 2 VL018
A capstan style valve suiting ball jointed products



Excelsior VL010
Thermostatic, a substantial valve in a time honoured design



Adapta VL001
A contemporary double angled valve, almost not to be noticed



Xero VL012
This modern tap head style suits many bathroom taps and fittings



Piazza VL014
Great for square tube products



Combination Kit VL013
Straight and angles valves for a dual energy option, applicable for all multirail products



Arne Corner VL023
Discreet and contemporary



Arne Corner VL023
Matt black or anthracite



Arne Corner VL024
Thermostatic corner valve



Arne Corner VL024
Matt black or anthracite

The Contemporary Colour Arne VL003 valves



*Arne VL003 valves are available in Chrome and White (9016) as standard or one of our Contemporary Colours as an option for the same price.



Dual Fuel Valves VL015
For both central heating and electric dual fuel options



Straight Valves



Angled Valves

Valve	Description	Type	Price (ex VAT) *Chrome	Price (inc VAT) *Chrome	Stock or made to order
Arne VL003	1/2" BSP X 15 mm	Straight	51.00	61.20	✓
Arne VL003	1/2" BSP X 15 mm	Angled	51.00	61.20	✓
Arne Thermostatic VL004	Chrome 1/2" BSP X 15 mm thermostatic	Straight	79.00	104.40	✓
Arne Thermostatic VL004	Chrome 1/2" BSP X 15 mm thermostatic	Angled	79.00	94.80	✓
Arne Thermostatic VL004	Matt Black 1/2" BSP X 15 mm thermostatic	Straight	79.00	94.80	✓
Arne Thermostatic VL004	Matt Black 1/2" BSP X 15 mm thermostatic	Angled	79.00	94.80	✓
Arne Thermostatic VL004	Anthracite 1/2" BSP X 15 mm thermostatic	Straight	79.00	94.80	✓
Arne Thermostatic VL004	Anthracite 1/2" BSP X 15 mm thermostatic	Angled	79.00	94.80	✓
Arne Thermostatic VL004	Brushed Brass 1/2" BSP X 15 mm thermostatic	Straight	85.00	102.00	✓
Arne Thermostatic VL004	Brushed Brass 1/2" BSP X 15 mm thermostatic	Angled	85.00	102.00	✓
Adapta VL001	1/2" BSP X 15 mm	Angled	75.00	90.00	✓
Xero VL012	1/2" BSP X 15 mm	Angled	54.00	64.80	✓
Piazza VL014	1/2" BSP X 15 mm	Angled	90.00	108.00	✓
Combination Kit VL013	1/2" BSP X 15 mm	Angled / Straight	63.00	75.60	✓

Valve	Description	Type	Price (ex VAT) Chrome	Price (inc VAT) Chrome	Stock or made to order
Art Deco VL006	1/2" BSP X 15 mm	Angled	81.00	97.20	✓
Crosshead VL008	1/2" BSP X 15 mm	Straight	66.00	79.20	✓
Crosshead VL008	1/2" BSP X 15 mm	Angled	66.00	79.20	✓
Excelsior VL010	1/2" BSP X 15 mm thermostatic	Angled	194.00	232.80	✓
Crosshead 2 VL018	1/2" BSP X 15 mm	Angled	54.00	64.80	✓
Arne Corner VL023	1/2" BSP X 15 mm	Corner	61.00	73.20	✓
Arne Corner VL023	Matt Black 1/2" BSP X 15 mm	Corner	61.00	73.20	✓
Arne Corner VL023	Anthracite 1/2" BSP X 15 mm	Corner	61.00	73.20	✓
Arne Corner Thermostatic VL024	Chrome 1/2" BSP X 15 mm thermostatic	Corner	90.00	118.80	✓
Arne Corner Thermostatic VL024	Matt Black 1/2" BSP X 15 mm thermostatic	Corner	90.00	108.00	✓
Arne Corner Thermostatic VL024	Anthracite 1/2" BSP X 15 mm thermostatic	Corner	90.00	108.00	✓
Dual Fuel VL015	1/2" BSP X 15 mm	Angled	52.00	62.40	✓

Vogue UK Painted Colours and Finishes

The colours and finishes below are available on many of our ranges carrying the RAL colour symbol. The featured colours have a £279.00 supplement ex VAT, on the white price. Other RAL colours are available POA.



Vogue UK Radiator Colours - POA



The RAL colours in this chart have been matched as closely as possible. The colour depends on the printing. We suggest an official RAL colour chart gives the most accurate representation.

Vogue UK Contemporary Colour Range



The contemporary colour range is available as a stocked item in three models Serene, Vela and Focus. White & Grey Sparkle Textured, Latte, Cappuccino, Mocha and Anthracite have a textured finish, with Espresso and Satin Black being gloss. These finishes are also available on other ranges.

Vogue UK Metallic Finishes



Please Note: Polished Brass and Polished Copper tube finishes, are supplied in a raw, un-lacquered finish, as standard. This un-lacquered (ie; unprotected) base material will discolour in a short period of time and will therefore require regular cleaning in order to maintain the finish. To add a lacquer to preserve the finish, add an additional 20% to the un-lacquered price. Brushed Brass will be supplied as a lacquered finish only and subject to an additional 20% supplement charge on top of the chrome finish price.

The supplements displayed on this page are **only** to be added to brass manufactured towel rails, please see the individual product page for full material information. Individual mild steel supplements can also be found on the product page. For more information regarding pricing contact sales on 01902 387 000.

Antique Bronze, Antique Brass & Antique Copper - Due to the reaction between the solution with the base metal there will always be a degree of natural variation in shading between different components.

Inset Radiator Range



Joins & Tubing

Selecting your joint and tube design could not be more flexible.

Our hand made selection of towel warmers can be as individual as you are.

Vogue UK Tubing Range



Rope

Reed

Plain

Hexagonal

Square

Vogue UK Joint Range



Ball Joint 1"



Legacy Ball Joint 1.25"



Originals Ball Joint



Charlotte Ball Joint 1.5"



Grandeur Joint



Cylinder Joint



Art Moderne Corner



Minama Square Corner



Romolo Joint



Art Linea Joint



Mitred Corner



Plain Corner



Contemporary Corner



Minama Round Corner



Valour Bend

General Information

Bespoke items are non-returnable. Please note that certain non-stock models are also non-returnable, please confirm with our Sales Office on telephone +44(0)1902 387000.

All heat outputs are shown at 50°CΔt, in compliance with BSEN442 - Specification for Radiators and Convectors. To convert to 60°CΔt, multiply heat output by conversion factor 1.264 (approximate figure), to convert to 70°CΔt, multiply heat output by conversion factor 1.549 (approximate figure).

All measurements given are nominal dimensions only (mm) and are not binding. Detailed technical drawings are available on request from our Sales Office on +44(0)1902 387000 or via our website - www.vogueuk.co.uk Manufactured from hot brass stamped fittings and high quality brass tube complying to BS EN 12449:2016+A1:2019. Some models are manufactured from high grade CR steel tubing and/or containing steel components suitable for closed/indirect circuits only. All rails are pressure tested to at least 5.4 bar (78psi) up to a maximum of 13 bar (189psi) air immersed in water. All models are fitted with two 1/2" BSP F.I. connections. Alternative M.I. or compression fitting is available on request. 3/4" BSP F.I. connections are available at extra cost on some models. A manual bleed air vent is fitted to all hot water/dual fuel models. Auto air vents are available on request at additional cost.

In compliance with our policy of constant improvement, we reserve the right to alter specifications, materials and dimensions or discontinue any of our products without prior notice. The colours in the brochure are as accurate as the colour printing processes allow. Photographs and images are for illustrative purposes only. We reserve the right to change specifications without prior notification.

Products ordered incorrectly or where the specification has changed will incur a restock charge. Bespoke/custom made products are non-refundable. Upon the return of a product Vogue (UK) Ltd reserves the right to refuse credit if the product is not made available upon an agreed collection/return in line with the Company's terms and conditions. A copy of the Company's full Terms and Conditions of Trading is available on request.

Installation

Vogue (UK) Ltd recommends that preparatory work such as the adjustment of existing pipework, the installation of new pipework, or the advance drilling of holes, etc. is not carried out until the towel warmer or radiator is on site and positioned for fitting.

Pipe centres are provided as a centre to centre tapings using the Vogue (UK) range of valves. Valves are NOT supplied with each product. Please see Valves & Accessories section for further details. All installations of a Vogue (UK) Ltd towel warmer or radiator should be in accordance with the following British Standards;

- BS 7593:2019 Code of Practice for the preparation, commissioning, and maintenance of domestic central heating and cooling water systems (In short, clean, protect, test & maintain).
- BS EN 14336:2004 Heating systems in buildings - Installation and commissioning of water-based heating systems
- BS EN 12828:2012 Heating systems in buildings - Design for water-based heating systems.

EN442.1 & 2

Where applicable product within this publication has undergone independent testing to verify heat outputs are in accordance with the parameters laid down in the above European standards.

EN60335

Household and similar electrical appliances. Safety.

Part 2 - 43 : 2003 + A2 : 2008

Where applicable all product within this publication utilising an electrical heating component, conform to the above safety standard.

ISO 9001:2015 Certified

Vogue (UK) Ltd is proud to be ISO 9001: 2015 certified.

Quality is utmost in importance to our organization, in both the products and services we provide our customers. Reflecting this commitment, Vogue (UK) Ltd implemented and received certification of our Quality Management System in accordance with ISO 9001:2015.

Construction Product Regulations (CPR)

In compliance with the above, Vogue (UK) Ltd (The company) holds declaration of Performance Certificates (DoPs) for all products covered by the Harmonised Standard EN442.1 / 2. Copies of relevant certificates are available on request. Some products at the time of print may be awaiting confirmation.

Product with a declared heat output of 200 Watt or less 50 degree C Delta T are not classified by The company as heating appliances and are therefore not covered by the above. All individually manufactured bespoke products are similarly exempted from the above legislation.

Warranty

Vogue (UK) Ltd is a company that celebrates the wealth of traditional, quality handcrafted heated towel warmers and radiators and is one of the last true manufacturers in the UK. Vogue branded towel warmers supplied and installed within UK are also covered by an extended 2, 15, or 30 Year product warranty -subject to our business trading Terms & Conditions against manufacturing defects. Components such as inset radiators, not of our manufacture, which become faulty by reason of defected materials, come with a 2 year warranty only.

Continual Improvement

Our company policy is one of continual improvement and Vogue (UK) Ltd reserves the right to amend designs, specification or discontinue any of our products without prior notice. E & OE.

Carriage

Paid UK mainland, excluding requests for next day service, Export carriage can also be arranged. Please contact our Sales Office for details on telephone +44(0)1902 387000.



Index

Model	Code	Material	Section	Style	Installation	Page
A						
Accessories	AC		A			156
Amie	CN065	MS	CN	MTW	WM	23
Aquila	DR016	MS	CN	DTW	WM	40
Arc	MD065	MS	CN	MTW	WM	29
Arc Matt Black	MD065	MS	CN	MTW	WM	28
Arcadia	LG017/OG017	MS/BR	TR	TTW	FM	92
Art Moderne	OG011	BR	TR	TTW	FW	104
Art Moderne	OG010	BR	TR	TTW	WM	105
Art Moderne II	OG021	BR	TR	MR	WM	106
Astute Compact	DR034	AL	DR	DR	WM	133
Astute Horizontal	DR036/DR036DP	AL	DR	DR	WM	132
Astute Towel Warmer	CN095	AL	CN	MTW	WM	65
Astute Vertical Double	DR035DP	AL	DR	DR	WM	135
Astute Vertical Single	DR035	AL	DR	DR	WM	134
Axis Chrome	MD062	MS	LR	MR	WM	68
Axis Matt Black	MD062	MS	LR	MR	WM	69
B						
Ballerina	LG024A-MS/LG021-MS	MS	TR	TTW	FW	94
Ballerina	LG024/LG021/OG003	BR	TR	TTW	FW	95
Ballerina	LG010A-MS	MS	TR	TTW	WM	96
Ballerina	LG025/LG010/LG021/OG002	BR	TR	TTW	WM	97
Baroque	LG014/OG016	BR	TR	TTW	FM	93
Basin Stands		BR	TR	TTW	FW/WM	114
Bathroom Zones			A			155
Binary	TR002	BR/MS	CN	S	WM	57
Boxa	CN009	MS	CN	MTW	WM	36
Butler	LG035/OG004	BR	TR	TTW	FW	100
C						
Carina	MD051	MS	CN	S	WM	60
Chic	MD046	MS	CN	DTW	WM	24
Chorus	MD002	MS	LR	MR	WM	73
Chube	MD035	SS	LR	MR	WM	76
Colonnade IV	LG023	BR	TR	TTW	WM	108
Colour options			A			162
Combes	MD063	MS	LR	MR	WM	70
Comby	MD052	MS	CN	MR/S	WM	58
Comfort	EL028	MS	E	MTW	WM	144
Concertina	DR010	MS	CN	DR/DTW	WM	12
Concord	DR041	MS	CN	DTW	WM	63
Contrast	MD079	MS	CN	MTW	WM	18
Curvee	MD050	MS	CN	MR	WM	42
Cygnus	DR012	MS	CN	DR/DTW	WM	14
Cygnus Harmonique	DR032	MS	CN	RTW	WM	15
D						
Decor	MD084	MS	CN	MTW	WM	44
Décor Harmonique	MD094	MS	CN	RTW	WM	45
Draco	DR015	MS	CN	MTW	WM	16
E						
Eco Modular Bars	ELTB12V	SS	E	MTW	WM	143
Electric Element & Dual Fuel Fitted Pricing			A			154
Electric Element Only	EE001/EE002/EE003/EE005/EE006		A			152
Electric Under Floor Heating	EUFH		E	UFH		146

Model	Code	Material	Section	Style	Installation	Page
E						
Elizabeth	LG003/OG019	MS/BR	TR	TTW	FW	102
Elizabeth	LG003/OG019	BR	TR	TTW	WM	103
Envirovent Electric Fans	SILD/ECO DMEV/SILM/SILENT		E			148
F						
Fly Line Horizontal	DR004/DR004DP	MS	DR	FR	WM	127
Fly Line Vertical	DR003/DR003DP	MS	DR	FR	WM	126
Fly Line II Horizontal	DR002/DR002DP	AL	DR	FR	WM	129
Fly Line II Vertical	DR001/DR001DP	AL	DR	FR	WM	128
Focus	MD001	MS	LR	MR	WM	72
Focus Colour Range	MD001	MS	LR	MR	WM	75
Focus Horizontal	MD001H	MS	LR	MR	WM	74
G						
Galaxy	MD059	SS	LR	MR	WM	78
Gallant	MD040SS	SS	CN	MR	WM	38
Gallant II	MD040MS	MS	CN	MR	WM	39
Grace	MD067	MS	CN	MTW	WM	20
Grandeur	GD032FW	BR	TR	TTW	FW	98
Grandeur	GD032WM	BR	TR	TTW	WM	99
H						
Hamlet	LG037/OG001	BR	TR	TTW	WM	101
Harmonique	MD060	MS	CN	RTW	WM	61
Harmonique Duo	MD090	MS	CN	RTW/S	WM	59
Heating Options			A			153
I						
Ideal	MD055	SS	CN	MTW	WM	35
Ieri	TM014-MS	MS	CN	S	WM	54
Ieri	TM014-BR	BR	CN	S	WM	55
Intra	CN013	MS	CN	MTW	WM	19
J						
Joints & Tubing			A			164
K						
Kate	DR019	MS	DR	DR/VT	WM	122
Kerve	MD036	SS	LR	MR	WM	77
Keys II	CN030	MS	CN	DTW	WM	25
L						
Lure Double	DR020DP	MS	DR	DR/VT	WM	131
Lure Single	DR020	MS	DR	DR/VT	WM	130
M						
Mantra V	CN075	MS	CN	MTW	WM	21
Marine	DR009	MS	CN	DR/DTW	WM	13
Melody	MD004	MS	LR	MR	WM	81
Metallic Finishes			A			163
Mode Accessories	AC					140
Mode Bespoke	2C/3C/4C/5C/6C	MS	DR	C	WM	141
Mode Column Radiator	2C/3C/4C	MS	DR	C	WM	138
Mode II	CN027	MS	DR	C	WM	136
N						
Nexus Grand III	TM003	BR	TR	RTW	WM	110
Nexus Grand IV	TM004	BR	TR	RTW	WM	111
Nexus III	TM001	BR	CN	RTW	WM	62
O						
Ordinate	MD005	MS	DR	VT	WM	123

Index

Model	Code	Material	Section	Style	Installation	Page
P						
Pearl	MD058	SS	LR	MR	WM	79
Penthouse	LG018/OG020	BR	TR	MR	WM	107
Phoenix	DR017	MS	CN	DTW	WM	41
Pure	MD037	BR	CN	MTW	WM	22
Q						
Quadrat	MD074	MS	CN	MTW	WM	30
Quadrat Harmonique	MD078	MS	CN	RTW	WM	31
R						
Regency	LG004-MS	MS	TR	TTW	FW	86
Regency	LG004-BR/OG006-BR	BR	TR	TTW	FW	87
Regency	LG005/OG015	MS/BR	TR	TTW	WM	88
Regency II	LG036/OG009	BR	TR	TTW	WM	89
Regency Tall	LG013-MS	MS	TR	TTW	FW/WM	90
Regency Tall	LG013-BR/OG007-BR	BR	TR	TTW	FW/WM	91
Rubik	MD038	SS	CN	MTW	WM	32
S						
Sequel III	TM005	BR	TR	RTW	WM	112
Sequel V	TM006	BR	TR	RTW	WM	113
Serenade	DR008	MS	DR	FR	WM	125
Serene	MD049	MS	CN	MR	WM	34
Shower Curtain Rails	SCR1 - 6	BR	TR		WM	116
Sierra	DR040	MS	CN	MTW	WM	17
Simplicity II	EL040/EL045	SS	E	VT	WM	145
Simplicity IV	IVCN026	BR	CN	TTW	WM	51
Smooth	CN035	MS	CN	MTW	WM	26
Smooth II	CN036	MS	CN	MTW	WM	27
Solo	TR001	BR/MS	CN	S	WM	56
Squire	MD047	MS	CN	MR	WM	33
Stella	MD034	SS	LR	MR	WM	82
Studio	MD006	BR	LR	MR	WM	83
Suave	MD056	MS	DR	FR	WM	120
T						
Tempo	MD072	MS	CN	MR	WM	64
Tune	MD003	MS	LR	MR	WM	80
U						
Unique	CN028	MS	CN	MTW	WM	46
Universal Shelf	AC067	MS	A	S	WM	158
V						
Valves	VL		A			160
Vela	MD048	MS	CN	MR	WM	43
Venture	CN022	BR	CN	TTW	WM	47
Vintage	LG010B	BR	TR	TTW	WM	109
Vision	DR022	MS	DR	DR/VT	WM	124
Vivid	CN021	BR	CN	TTW	WM	48
Vivid II	CN029	BR	CN	TTW	WM	49
Vivid IV	IVCN021	BR	CN	TTW	WM	50
Vivid IV Single Bar	IVCN021	BR	CN	TTW	WM	52
Vivid IV Horizontal	IVCN021	BR	CN	TTW	WM	53
Z						
Zenith	IN007	SS	CN	DTW	WM	37
Zest	MD076	MS	DR	FR	WM	121

Innovation

Vogue UK is a vibrant organisation with research being conducted in many technology disciplines. This research results in exciting products as evidenced throughout the design collections we offer. Vogue UK has set itself a clear objective: both through consistent preservation and long tradition of British craftsmanship and meeting its high standards, as well as creating, with its very own innovative heating developments, contemporary design and a heightened passion for detail and perfection.

Those who appreciate lasting value derived from the synergy of traditional craftsmanship, creative development and the latest technology, as well as dedication in seeking the extraordinary know not to entrust any towel rail design but rather to a design crafted from Vogue (UK).

Vogue UK emphasises its creative drive to differentiate its towel rail designs down to the finest detail and its desire to monitor, to the greatest possible extent, the development and manufacture of a hand crafted product. We use the latest technology to produce low-volume individual parts with high added value continuously offering home interiors and connoisseurs of design new, impressive towel rail models.

Environment

Vogue UK has a legacy of core values, rooted strongly in safety, health and environmental stewardship. For 30 years, we have been reducing the environmental footprint of our own operations. Today, footprint reduction is expected of all companies. The challenge – and the opportunity – are products and manufacturing processes that are safer, less toxic, more energy efficient, use less water, less energy, and produce fewer greenhouse gases.

We're working to conserve energy and reduce waste and are exploring the use of sustainable materials and products. Whether we're saving costs by reducing energy consumption or creating covetable products through innovative, sustainable design, we believe that reducing our impact on the environment can also result in positive business benefits.

INDEX KEY

Style	Material	Section	Installation
C	Column radiator	BR	Brass
DR	Designer radiator	MS	Mild Steel
DTW	Designer towel warmer	SS	Stainless Steel
ER	Electric radiator	AL	Aluminium
FR	Flat Radiator	CI	Cast Iron
MR	Multirail		
MTW	Modern towel warmer		
RTW	Radiator towel warmer		
S	Shelf		
TTW	Traditional towel warmer		
UFH	Under floor heating		
VT	Vertical tube		

Vogue (UK) Ltd
Strawberry Lane
Willenhall, West Midlands
WV13 3RS United Kingdom

T: +44(0) 1902 387000 E: sales@vogueuk.co.uk W: www.vogueuk.co.uk



VOGUE UK
TOWEL WARMERS & RADIATORS

Vogue (UK) Ltd
Strawberry Lane
Willenhall, West Midlands
WV13 3RS United Kingdom

T: +44(0) 1902 387000

E: sales@vogueuk.co.uk W: www.vogueuk.co.uk

Vogue UK is a business within the Brand K Group of companies.

