

Miller

FINE BATHROOM INTERIORS



BATHROOM ACCESSORIES AND FURNITURE

Your way. The Miller Way.

Given how much time your family spends in the bathroom you deserve something extra. As a timeless and beautiful design, just like your family, it becomes more beautiful with age. Added care is given to the selected materials and finish, along with all the little details that make the products so beautiful. And not least, the choice that will give you the bathroom you really desire.

We believe that it is important your whole family enjoys dealing with us, as we ourselves are a family business that for five generations has delivered quality, authenticity and tradition. We believe that your family deserves a good quality of life, even in the bathroom. We call it the Miller Way.



page 4 Bathroom Accessories



page 66 Bathroom Furniture



Tradition

In 1903, two brothers, Justus and Fritz Miller started casting furniture fittings in little Printzeryd in Sweden. They were skilled craftsmen who took great care with the fittings they supplied to make sure that they were of the highest quality. Today, over 100 years later, that same philosophy stands and with the business still under the Miller's ownership, and the family remains fully committed to the production of high quality, visually stunning products which stand the test of time.





‘Beneath the surface there are all those little details that become more important over the years’

We know the surface is important in bathrooms. That’s the first thing your eyes see when you enter the room. A beautiful wall cabinet, the clean lines of a vanity unit, an elegantly shaped porcelain sink creates that special first impression. But it’s once you get to know your bathroom a little closer you will appreciate our attention to detail. Beneath the surface there are all those little details that become more important over the years.

We select wood with beautiful veining and finish with hard wearing, protective lacquer. We are careful to design drawers and doors which always open and close smoothly. We have thought about the extra storage that will be practical and functional. Everything we design is for a long lasting friendship. This is when the small details combine with the beautiful surfaces to give you a special bathroom – the Miller Way.

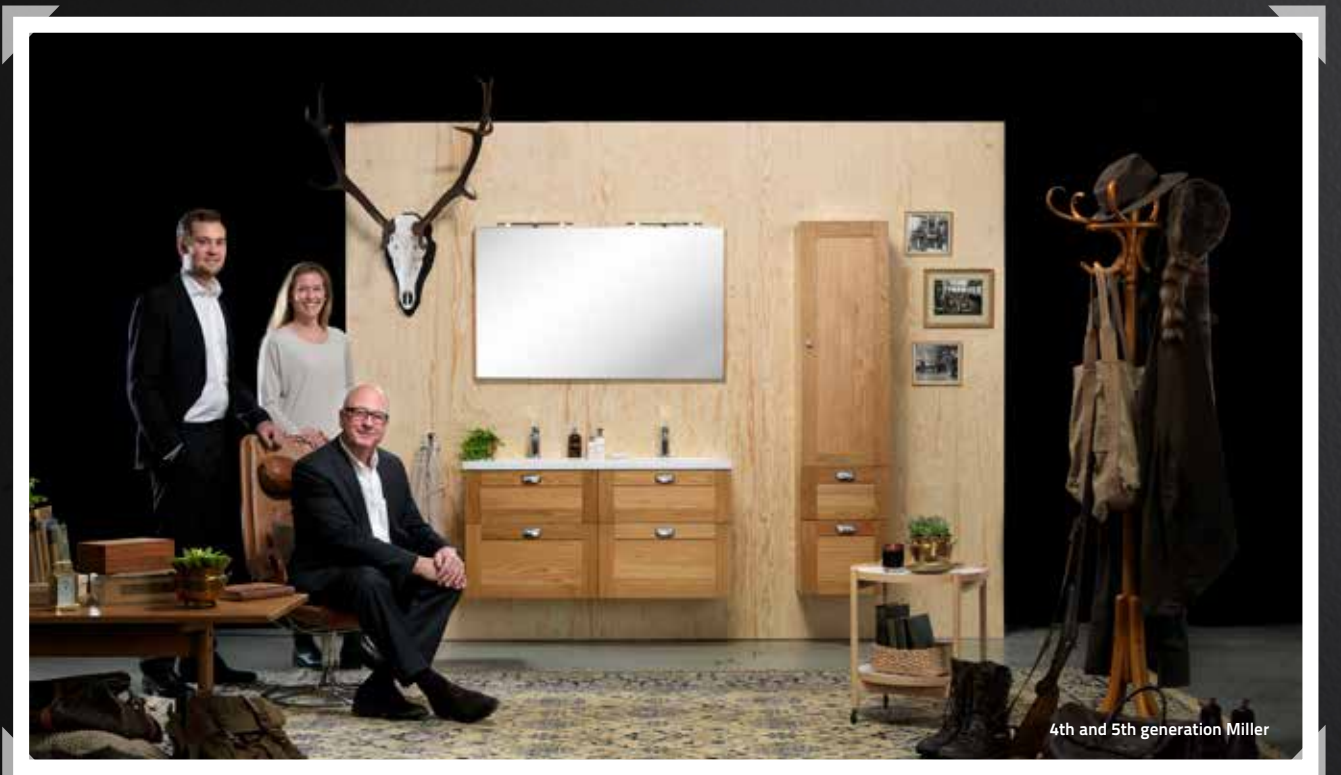

4th and 5th generation Miller

Bathroom Accessories

The perfect way to finish your bathroom is with the addition of one of Miller from Sweden's beautiful accessory collections. Thoughtfully designed to compliment our furniture, there are many stylish and innovative solutions to choose from.



- | | | | |
|----|-----------------------|----|-------------------|
| 6 | Atlanta Chrome | 30 | Montana |
| 8 | Atlanta Black | 32 | Orlando |
| 10 | Bond Chrome | 34 | Oslo Chrome |
| 12 | Bond Black | 36 | Oslo Nickel |
| 14 | Bond Polished Brass | 38 | Richmond |
| 16 | Bond Brushed Brass | 40 | Stockholm |
| 18 | Boston | 44 | Classic Accessory |
| 20 | Denver | 64 | Lily & Cube |
| 22 | Metro | | |
| 24 | Miami Chrome | | |
| 26 | Miami Black | | |
| 28 | Miami Stainless Steel | | |



These accessories can also be fixed with our adhesive. All accessories are supplied with a wall screw pack. For "No drill" fixing purchase our fixing adhesive.





Atlanta Chrome **6**



Atlanta Black **8**



Bond Chrome **10**



Bond Black **12**



Bond Polished Brass **14**



Bond Brushed Brass **16**



Boston **18**



Denver **20**



Metro **22**



Miami Chrome **24**



Miami Black **26**



Miami Stainless Steel **28**



Montana **30**



Orlando **32**



Oslo Chrome **34**



Oslo Nickel **36**

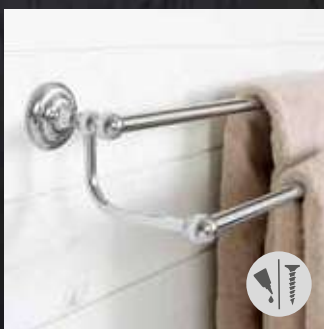

Richmond **38**



Stockholm **40**



Classic Accessory **44**



Lily and Cube **64**

ATLANTA

Atlanta's pure form and function provides a perfect balance of design and practicality. Benefiting from our full-fix system, this beautiful, chrome plated collection, provides everything you could wish for the finishing of your bathroom.

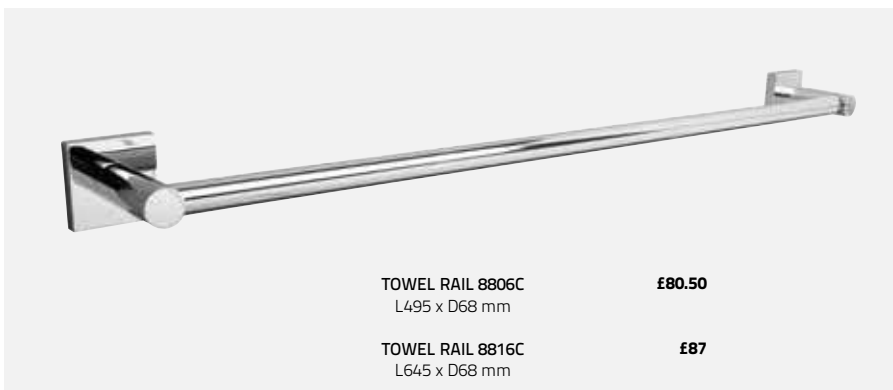

Screws are included. This collection can also be fixed with our Fixing Adhesive.

We recommend that towel rails, glass shelves, mirrors, toilet brush sets, grab bars and products that carry heavy weight are screw fixed.



10 year Guarantee

Read more about the Miller Way on www.millerbathrooms.co.uk



'Full-fix 'anti twist' is a fixing system which prevents the accessory from turning when fitted.

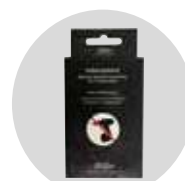

Fixing Adhesive £16
Fixing Adhesive code no. 8798
Glue always sold separately.
Read more on millerbathrooms.co.uk

LEARN MORE

Find more matching items within the Classic Collection. Page 44.

For detailed measurements please see www.millerbathrooms.co.uk

Backplate 45 x 45 mm



ATLANTA BLACK

Atlanta's pure form and function provides a perfect balance of design and practicality. Benefiting from our full-fix system, this beautiful, matt black collection, provides everything you could wish for the finishing of your bathroom.



Screws are included. This collection can also be fixed with our Fixing Adhesive.

We recommend that towel rails, glass shelves, mirrors, toilet brush sets, grab bars and products that carry heavy weight are screw fixed.



10 year Guarantee

Read more about the Miller Way on www.millerbathrooms.co.uk



Full-fix 'anti twist' is a fixing system which prevents the accessory from turning when fitted.

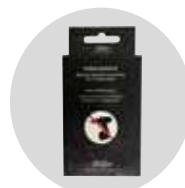

Fixing Adhesive £16
Fixing Adhesive code no. 8798
Glue always sold separately.
Read more on millerbathrooms.co.uk

LEARN MORE

Find more matching Matt Black items within the Classic Collection. Page 44.

For detailed measurements please see www.millerbathrooms.co.uk



BOND

A modern day classic collection featuring pure, simple clean lines, finished in polished chrome with complimentary glass component parts. Bond benefits from our full-fix system to prevent twisting, making it even more desirable and the perfect range for today's modern home.



£47.25

TOILET ROLL HOLDER 8710C
W150 x H105 mm



£61.25

TOILET ROLL HOLDER 8707C
with lid
W135 x H145 mm



£75.25

DOUBLE POST TOILET ROLL HOLDER 8737C
W205 x D70 mm

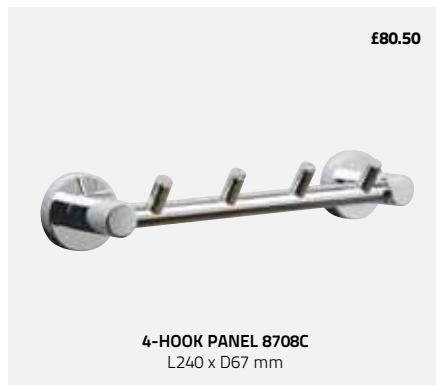

£80.50

4-HOOK PANEL 8708C
L240 x D67 mm



£58

SPARE ROLL HOLDER 8719C
H155 x D70 mm



TOWEL RAIL 8706C **£75.25**
L495 x D80 mm

TOWEL RAIL 8716C **£82.75**
L645 x D80 mm



£120.75

MIRROR 8700C
Round, bevelled
Ø450 mm
Range mirror is guaranteed for 2 years.



£121.25

TOWEL RAIL 8727C
Double
L645 x D155 mm



Screws are included. This collection can also be fixed with our Fixing Adhesive.

We recommend that towel rails, glass shelves, mirrors, toilet brush sets, grab bars and products that carry heavy weight are screw fixed.



10 year Guarantee

Read more about the Miller Way on www.millerbathrooms.co.uk



Full-fix 'anti twist' is a fixing system which prevents the accessory from turning when fitted.

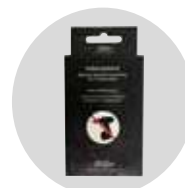

Fixing Adhesive £16
Fixing Adhesive code no. 8798
Glue always sold separately.
Read more on millerbathrooms.co.uk

LEARN MORE

Find more matching items within the Classic Collection. Page 44.

For detailed measurements please see www.millerbathrooms.co.uk



£94.50

GLUABLE D-SHAPED BASKET 866CG
CHROME FINISH

Suitable for straight wall application
With practical hook
W250 x H80 x D125 mm



£96.75

TOILET BRUSH SET 8721C

Chrome, wall hung
D120 x H425 mm



£39.75

DOUBLE ROBE HOOK 8712C

H135 x D85 mm



£47.25

TOWEL RING 8705C
Ø170 mm



£81.50

LOTION BOTTLE 8734C
Frosted glass
H170 x D130 mm



£33.75

DOUBLE HOOK 8723C
D58 mm



£30

SINGLE HOOK 8722C
D58 mm



£47.25

TUMBLER HOLDER 8703C
Clear glass
H100 x D130 mm



£116

SHELF 8702C
Guard rail in chrome, clear hardened glass
L500 x D120 mm



£47.25

SOAP DISH 8704C
Clear glass
Ø110 x D145 mm

BOND BLACK

A modern day classic collection featuring pure, simple clean lines, finished in matt black colour with complimentary glass component parts. Bond benefits from our full-fix system to prevent twisting, making it even more desirable and the perfect range for today's modern home.



£51.50

TOILET ROLL HOLDER 8710B
W150 x H105 mm



Also available as a corner basket

Total £106.25



D-SHAPED BASKET 866B £96.75
GLUABLE WALL BRACKETS 2-PACK BG1 £9.50
Suitable for straight wall application, With practical hook
W250 x H80 x D125 mm
MATT BLACK FINISH



Available in lengths 300, 400, 500, 600 mm

Total £104.50

GLASS SHELF L400 MM 81024 £34.75
BRACKET 8102B £69.75
Total length 400 mm
MATT BLACK FINISH



£51.50

SOAP DISH 8704B
Clear glass
Ø110 x D145 mm



£125

SHELF 8702B
Guard rail in black finish, clear hardened glass
L500 x D120 mm



£51.50

TUMBLER HOLDER 8703B
Clear glass
H100 x D130 mm



TOWEL RAIL 8706B
L495 x D80 mm

£83.25

TOWEL RAIL 8716B
L645 x D80 mm

£89.75



Screws are included. This collection can also be fixed with our Fixing Adhesive.

We recommend that towel rails, glass shelves, mirrors, toilet brush sets, grab bars and products that carry heavy weight are screw fixed.



10 year Guarantee

Read more about the Miller Way on www.millerbathrooms.co.uk



'Full-fix 'anti twist' is a fixing system which prevents the accessory from turning when fitted.

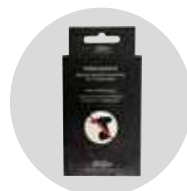

Fixing Adhesive £16
Fixing Adhesive code no. 8798
Glue always sold separately.
Read more on millerbathrooms.co.uk

LEARN MORE

Find more matching Matt Black items within the Classic Collection. Page 44.

For detailed measurements please see www.millerbathrooms.co.uk

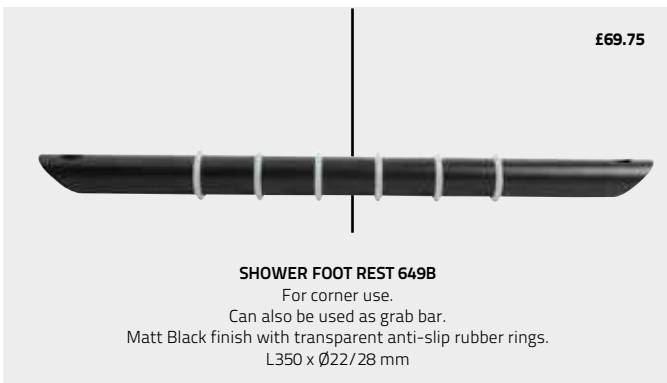

BOND BRASS

These accessories are made of polished untreated brass and a beautiful patina is created over time. Match with our handles and taps in the same finish.



Screws are included. This collection can also be fixed with our Fixing Adhesive.

We recommend that towel rails, glass shelves, mirrors, toilet brush sets, grab bars and products that carry heavy weight are screw fixed.



10 year Guarantee

Read more about the Miller Way on www.millerbathrooms.co.uk



'Full-fix' 'anti twist' is a fixing system which prevents the accessory from turning when fitted.

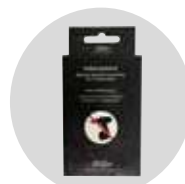

Fixing Adhesive £16
Fixing Adhesive code no. 8798
Glue always sold separately.
Read more on millerbathrooms.co.uk

LEARN MORE

Find more matching items within the Classic Collection. Page 44.

For detailed measurements please see www.millerbathrooms.co.uk

Polished Untreated Brass with a living surface. Beautiful patina is created over time.
Backplate diameter Ø45 mm

Total £108.25



D-SHAPED BASKET 866MP £98.75
GLUABLE WALL BRACKETS 2-PACK MPG1 £9.50
 Suitable for straight wall application, With practical hook
 W250 x H80 x D125 mm
POLISHED UNTREATED BRASS



£98.75



SCREW FIXED D-SHAPED BASKET 866MP
POLISHED UNTREATED BRASS
 Suitable for straight wall application
 With practical hook
 W250 x H80 x D120 mm

Total £108.25



GLUABLE CORNER BASKET 856MP £98.75
GLUABLE WALL BRACKETS 2-PACK MPG1 £9.50
 With practical hook
 W235 x H80 x D175 mm
POLISHED UNTREATED BRASS



£98.75



SCREW FIXED CORNER BASKET 856MP
POLISHED UNTREATED BRASS
 With practical hook
 W235 x H80 x D175 mm

Total £100.75



GLASS SHELF 300 MM 810230 £30
BRACKET 8102MP £70.75
 L300 mm
POLISHED UNTREATED BRASS

Total £113.75



GLASS SHELF 500 MM 810250 £43
BRACKET 8102MP £70.75
 L500 mm
POLISHED UNTREATED BRASS

Total £105.5



GLASS SHELF 400 MM 810240 £34.75
BRACKET 8102MP £70.75
 L400 mm
POLISHED UNTREATED BRASS

Total £119



GLASS SHELF 600 MM 810260 £48.25
BRACKET 8102MP £70.75
 L600 mm
POLISHED UNTREATED BRASS

BOND BRUSHED BRASS

A modern day classic collection featuring pure, simple clean lines, finished in brushed laquered brass with complimentary glass component parts. Bond benefits from our full-fix system to prevent twisting, making it even more desirable and the perfect range for today's modern home.

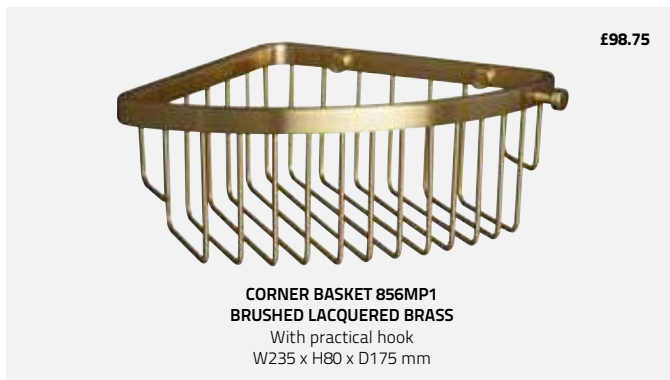
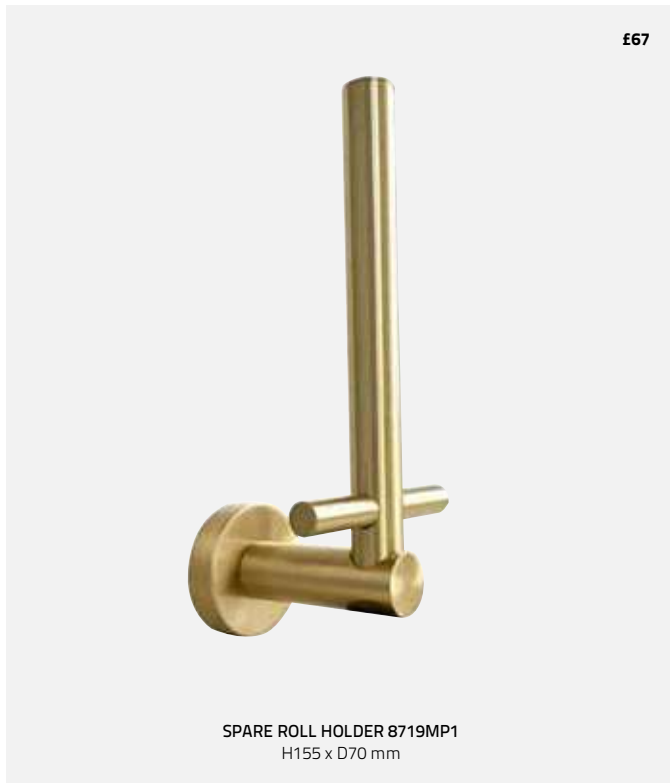

Screws are included. This collection can also be fixed with our Fixing Adhesive.

We recommend that towel rails, glass shelves, mirrors, toilet brush sets, grab bars and products that carry heavy weight are screw fixed.



10 year Guarantee

Read more about the Miller Way on www.millerbathrooms.co.uk



'Full-fix 'anti twist' is a fixing system which prevents the accessory from turning when fitted.

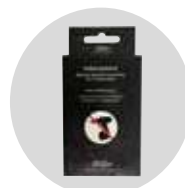

Fixing Adhesive £16
Fixing Adhesive code no. 8798
Glue always sold separately.
Read more on millerbathrooms.co.uk

LEARN MORE

For detailed measurements please see www.millerbathrooms.co.uk

Find more matching items within the Classic Collection. Page 44.



BOSTON

Architecturally inspired to produce a stunning image of sharp, clean angles and industrial style effects, the Boston collection benefits from full-fix fittings and is manufactured from solid brass. Its striking chrome lustre and beautiful ceramic components help to create a new contemporary classic.



£112.75

LOTION BOTTLE 8134C
White ceramic
W75 x H175 x D110 mm



£44

DOUBLE HOOK 8123C
W100 x H30 x D56 mm

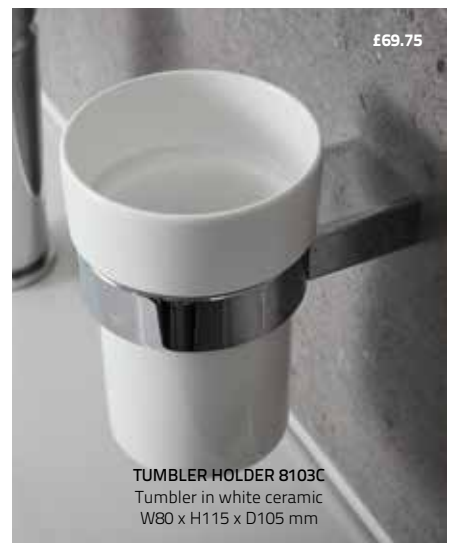

£69.75

TUMBLER HOLDER 8103C
Tumbler in white ceramic
W80 x H115 x D105 mm



SWIVEL TOILET ROLL HOLDER 8107C £64.50
Swivel arm. Right or Left arm positioning.
W146 x H62 x D74 mm



£69.75

SOAP DISH 8104C
Dish in white ceramic
W125 x H40 x D130 mm



Screws are included. This collection can also be fixed with our Fixing Adhesive.

We recommend that towel rails, glass shelves, mirrors, toilet brush sets, grab bars and products that carry heavy weight are screw fixed.



Lifetime Guarantee

Read more about the Miller Way on www.millerbathrooms.co.uk



'Full-fix 'anti twist' is a fixing system which prevents the accessory from turning when fitted.

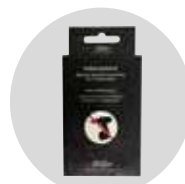

Fixing Adhesive £16
Fixing Adhesive code no. 8798
Glue always sold separately.
Read more on millerbathrooms.co.uk

LEARN MORE

Find more matching items within the Classic Collection. Page 44.

For detailed measurements please see www.millerbathrooms.co.uk



GLASS SHELF
8 mm clear hardened glass
Solid brass in chrome finish
Bracket L150 x H25 mm
Depth of shelf incl. bracket 120 mm

810230C L300 mm **£90.75**
810240C L400 mm **£94.50**
810250C L500 mm **£101.50**
810260C L600 mm **£106.25**



DENVER

Denver is a statement of style. Drawing its inspiration from cubism, this forged brass collection softens hard lines with soft curves to produce a truly eclectic mix of shapes. With the added feature of the full-fix system. Denver epitomises 'bathroom architecture'. All products in chrome finish.

£62.75



TOILET ROLL HOLDER 6410C
W160 x H150 mm

£95.50



TOILET ROLL HOLDER 6437C
W185 x D75, c/c 150 mm

£62.75



TUMBLER HOLDER 6403C
Clear glass
H100 x D110 mm

£95



LOTION BOTTLE 6434C
Clear glass
H165 x D130 mm



Screws are included. This collection can also be fixed with our Fixing Adhesive.

We recommend that towel rails, glass shelves, mirrors, toilet brush sets, grab bars and products that carry heavy weight are screw fixed.



Lifetime Guarantee

Read more about the Miller Way on www.millerbathrooms.co.uk



Full-fix 'anti twist' is a fixing system which prevents the accessory from turning when fitted.

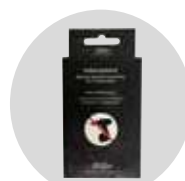

Fixing Adhesive £16
Fixing Adhesive code no. 8798
Glue always sold separately.
Read more on millerbathrooms.co.uk

LEARN MORE

Find more matching items within the Classic Collection. Page 44.

For detailed measurements please see www.millerbathrooms.co.uk

£137.50



MIRROR 6400C
Brushed bevelled edge
W420 x H500 mm
Range mirror is guaranteed for 12 months

£62.75



TOWEL RING 6405C
W178 x H150 mm

£97.25



TOWEL RAIL 6406C
L490 x D75 mm

£154.75



DOUBLE TOWEL RAIL 6427C
L650 x D132 mm

£34.75



SINGLE ROBE HOOK 6411C
D54 mm

£41



DOUBLE ROBE HOOK 6423C
W50 x D50 mm

METRO

Metro is an exceptional range of innovative brass accessories, finished in chrome and complimented by a satin chrome decorative ring on the back plate. Featuring frosted glass component parts, the stylish 'mixage' finish creates an outstanding collection of contemporary products.

£55.75



TOILET ROLL HOLDER 6310C-S
W170 x D55 mm

£55.75



TOWEL RING 6305C-S
Ø155 mm

£53.75



TUMBLER HOLDER 6303C-S
Frosted glass
H100 x D110 mm

£53.75



SOAP DISH 6304C-S
Frosted glass
Ø110 x D130 mm



This collection is screwfixed.
Screws are included



10 year Guarantee

Read more about
the Miller Way on
www.millerbathrooms.co.uk

LEARN MORE

For detailed measurements
please see www.millerbathrooms.co.uk

Solid brass in chrome finish. With a decorative satin chrome ring.
Backplate 37 x 37 mm

£118.25



MIRROR 6300C-S
Frosted bevelled edge,
round mirror Ø450 mm
Range mirror is guaranteed for 2 years.

£145



DOUBLE TOWEL RAIL 6327C-S
L655 x D160 mm



TOWEL RAIL 6306C-S **£90.25**
L505 x D75 mm

TOWEL RAIL 6316C-S **£96.75**
L655 x D75 mm

£107.50



GLASS SHELF 6302C-S
L500 x D125 mm

£33.75



SINGLE ROBE HOOK 6311C-S
D50 mm

£43



DOUBLE ROBE HOOK 6323C-S
W80 x D50 mm

MIAMI CHROME

Miami's strong form and contemporary shape is both elegant and stylish. Created from solid brass, finished by hand and chrome plated to a very high standard. It features our full-fix wall fitting system to ensure your accessories will enhance your bathroom for many years to come.



Screws are included. This collection can also be fixed with our Fixing Adhesive.

We recommend that towel rails, glass shelves, mirrors, toilet brush sets, grab bars and products that carry heavy weight are screw fixed.



Lifetime Guarantee

Read more about the Miller Way on www.millerbathrooms.co.uk



Full-fix 'anti twist' is a fixing system which prevents the accessory from turning when fitted.

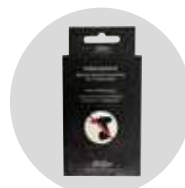

Fixing Adhesive £16
Fixing Adhesive code no. 8798
Glue always sold separately.
Read more on millerbathrooms.co.uk

LEARN MORE

For detailed measurements please see www.millerbathrooms.co.uk

Miami is also available in Matt Black finish and Stainless Steel finish.

Find more matching items within the Classic Collection. Page 44.

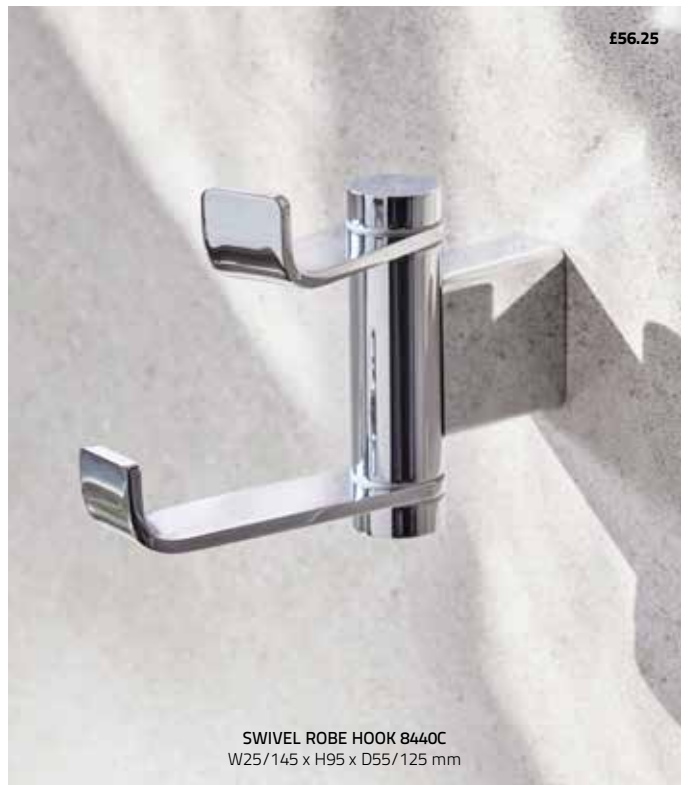

MIAMI BLACK



Screws are included. This collection can also be fixed with our Fixing Adhesive.

We recommend that towel rails, glass shelves, mirrors, toilet brush sets, grab bars and products that carry heavy weight are screw fixed.



Lifetime Guarantee

Read more about the Miller Way on www.millerbathrooms.co.uk



Full-fix 'anti twist' is a fixing system which prevents the accessory from turning when fitted.

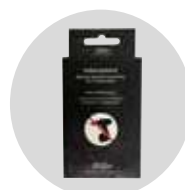

Fixing Adhesive £16
Fixing Adhesive code no. 8798
Glue always sold separately.
Read more on millerbathrooms.co.uk

LEARN MORE

For detailed measurements please see www.millerbathrooms.co.uk

Miami is also available in Chrome and Stainless Steel finish.

Find more matching items within the Classic Collection. Page 44.



MIAMI STAINLESS STEEL

Solid brass in Stainless Steel finish.



Screws are included. This collection can also be fixed with our Fixing Adhesive.

We recommend that towel rails, glass shelves, mirrors, toilet brush sets, grab bars and products that carry heavy weight are screw fixed.



Lifetime Guarantee

Read more about the Miller Way on www.millerbathrooms.co.uk



'Full-fix' 'anti twist' is a fixing system which prevents the accessory from turning when fitted.

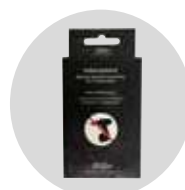

Fixing Adhesive £16
Fixing Adhesive code no. 8798
Glue always sold separately.
Read more on millerbathrooms.co.uk

LEARN MORE

For detailed measurements please see www.millerbathrooms.co.uk

Miami is also available in Chrome and Matt Black finish.

Find more matching items within the Classic Collection. Page 44.



MONTANA

Montana's contemporary styling perfectly accessorises today's modern bathrooms. Crafted from solid brass and hand finished. The range demonstrates a refreshing uniqueness of design. Montana also features the outstanding full-fix system, preventing your products from twisting.



Screws are included. This collection can also be fixed with our Fixing Adhesive.

We recommend that towel rails, glass shelves, mirrors, toilet brush sets, grab bars and products that carry heavy weight are screw fixed.



Lifetime Guarantee

Read more about the Miller Way on www.millerbathrooms.co.uk



'Full-fix 'anti twist' is a fixing system which prevents the accessory from turning when fitted.

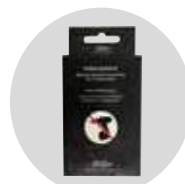

Fixing Adhesive £16
Fixing Adhesive code no. 8798
Glue always sold separately.
Read more on millerbathrooms.co.uk

LEARN MORE

For detailed measurements please see www.millerbathrooms.co.uk

Find more matching items within the Classic Collection. Page 44.

£80.50



TOWEL RING 6725C
W140 x H180 mm

£246



DOUBLE TOWEL RAIL 6727C
L650 x H105 x D130 mm

£39.75



SINGLE HOOK 6711C
D50 mm

£244



MIRROR 6741C
Swivel, rectangular, bevelled
Total W500 x H500 mm
Mirror size W420 x H500 mm
Range mirror is guaranteed for 2 years.

£55.25



DOUBLE ROBE HOOK 6723C
W75 x D50 mm

GLASS SHELF
8 mm clear hardened glass
Solid brass in chrome finish
Bracket L150 x H25 mm
Depth of shelf incl. bracket 120 mm

810230C L300 mm **£90.75**

810240C L400 mm **£94.50**

810250C L500 mm **£101.50**

810260C L600 mm **£106.25**

L300 mm

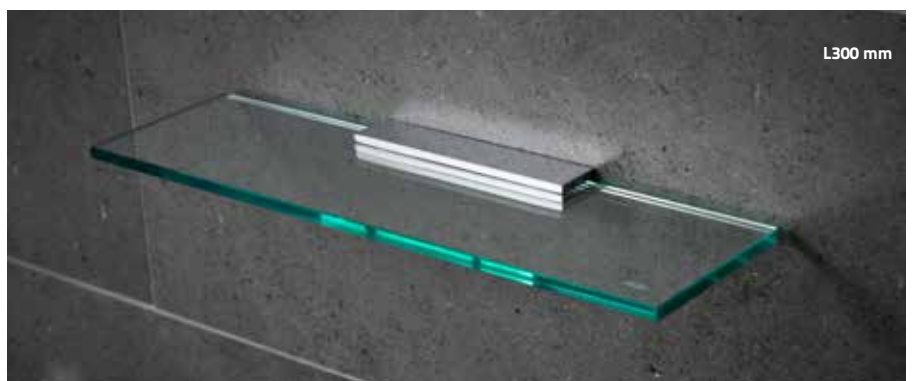

ORLANDO

Sweeping curves, crafted from solid brass and finished in sharp chrome, effortlessly combined with crisp, clean ceramic components are the key features of the Orlando collection. Unquestionably where modern style, combines with full-fix fittings to inspire an imperious range of products.



£112.75

LOTION BOTTLE 8134C
White ceramic
W75 x H175 x D110 mm



£50.50

ROBE HOOK 8212C
W22 x H115 x D87 mm



£41.75

HOOK 8211C
W22 x H61 x D68 mm



£69.75

TUMBLER HOLDER 8103C
Tumbler in white ceramic
W80 x H115 x D105 mm



£69.75

SOAP DISH 8104C
Dish in white ceramic
W125 x H40 x D130 mm



Screws are included. This collection can also be fixed with our Fixing Adhesive.

We recommend that towel rails, glass shelves, mirrors, toilet brush sets, grab bars and products that carry heavy weight are screw fixed.



Lifetime Guarantee

Read more about the Miller Way on www.millerbathrooms.co.uk



'Full-fix 'anti twist' is a fixing system which prevents the accessory from turning when fitted.



Fixing Adhesive £16
Fixing Adhesive code no. 8798
Glue always sold separately.
Read more on millerbathrooms.co.uk

LEARN MORE

For detailed measurements please see www.millerbathrooms.co.uk

Find more matching items within the Classic Collection. Page 44.

Solid brass in Chrome finish.



TOWEL HOLDER 8205C
W200 x H22 x D105 mm



TOILET ROLL HOLDER 8210C
W150 x H22 x D105 mm



TOWEL RAIL 8206C
L500 x H22 x D105 mm

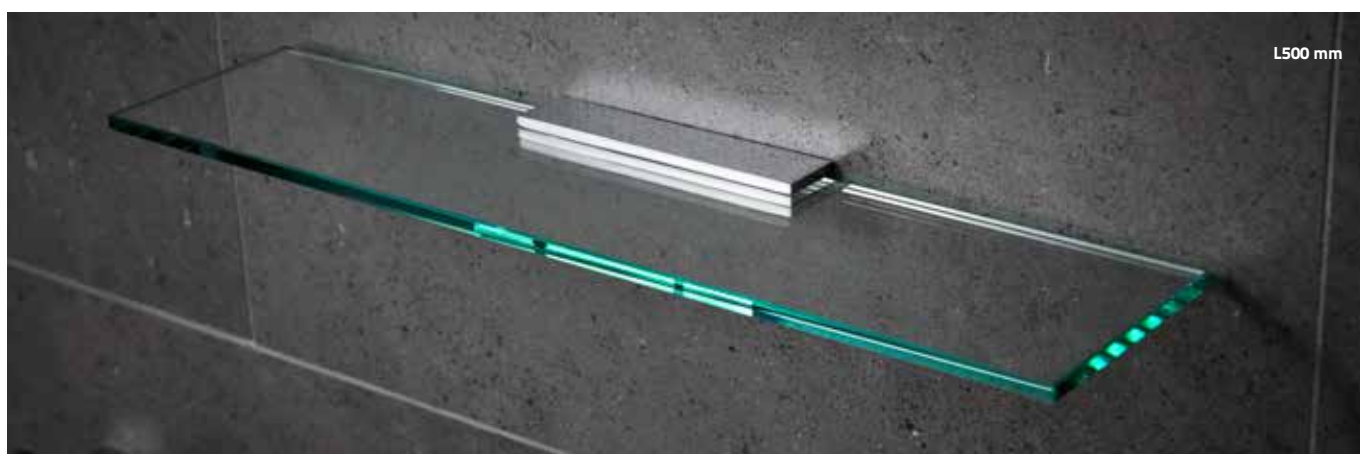

L500 mm

GLASS SHELF
8 mm clear hardened glass
Solid brass in chrome finish
Bracket L150 x H25 mm
Depth of shelf incl. bracket 120 mm

810230C L300 mm **£90.75**

810240C L400 mm **£94.50**

810250C L500 mm **£101.50**

810260C L600 mm **£106.25**

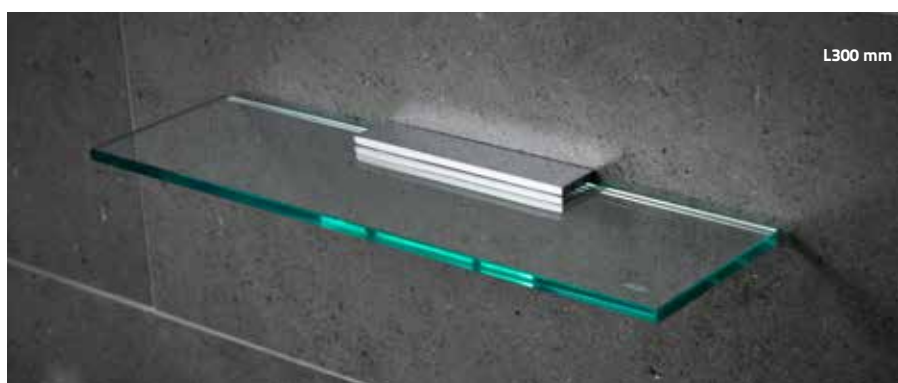

L300 mm

OSLO CHROME

Oslo's functional design, created in brass and finished in chrome, combined with its outstanding choice of items has made it the perfect collection for either a contemporary or a traditional setting.



Screws are included.
This collection can also be fixed with our Fixing Adhesive.

We recommend that towel rails, glass shelves, mirrors, toilet brush sets, grab bars and products that carry heavy weight are screw fixed.



10 year Guarantee

Read more about the Miller Way on www.millerbathrooms.co.uk

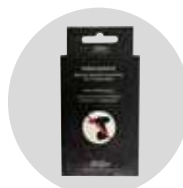

Fixing Adhesive £16
Fixing Adhesive code no. 8798
Glue always sold separately.
Read more on millerbathrooms.co.uk

LEARN MORE

For detailed measurements please see www.millerbathrooms.co.uk

Find more matching items within the Classic Collection. Page 44.

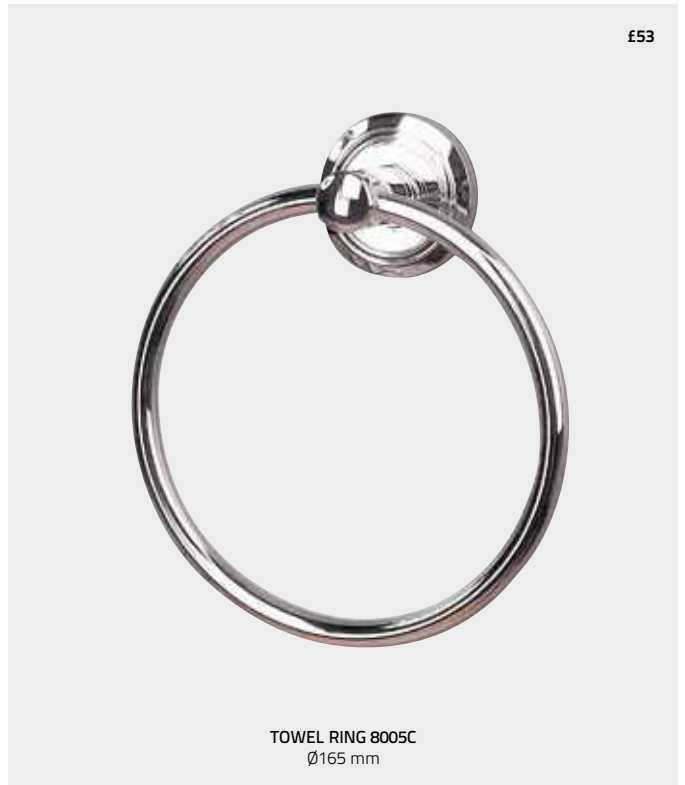

OSLO POLISHED NICKEL

Oslo is a classic range perfect for both contemporary and traditional bathrooms. Crafted from solid brass and finished in a polished nickel finish. Oslo is a range that definitely stands the test of time.



Screws are included. This collection can also be fixed with our Fixing Adhesive.

We recommend that towel rails, glass shelves, mirrors, toilet brush sets, grab bars and products that carry heavy weight are screw fixed.



10 year Guarantee

Read more about the Miller Way on www.millerbathrooms.co.uk



Fixing Adhesive £16
Fixing Adhesive code no. 8798
Glue always sold separately.
Read more on millerbathrooms.co.uk

LEARN MORE

For detailed measurements please see www.millerbathrooms.co.uk

£38.50



SINGLE HOOK 8022MN
D62 X H65 mm

£59



TOWEL RING 8005MN
H190 x W168 x D54 mm

£47.25



DOUBLE HOOK 8023MN
D58 x H62 mm

£172



DOUBLE TOWEL RAIL 8027MN
L655 x D150 mm

£92.25



TOWEL RAIL 8006MN
L505 x D75 mm

£117



TOILET BRUSH SET 8021MN
Wall-mounted, white ceramic bowl
H365 x Ø110 mm

£108.50



GLASS SHELF 8002MN
Clear hardened glass
L500 x D125 x H56 mm

£141.75



MIRROR 8000MN
Oval mirror W400 x H505 mm
Range mirror is guaranteed for 2 years.

RICHMOND

Richmond's stylish curves combine with modern manufacturing methods to create a perfect fusion. Crafted from solid brass, beautifully finished in hard wearing chrome and perfectly complimented with delicate, white ceramic components, the Richmond collection is truly a classic 'for today'.



£53.75

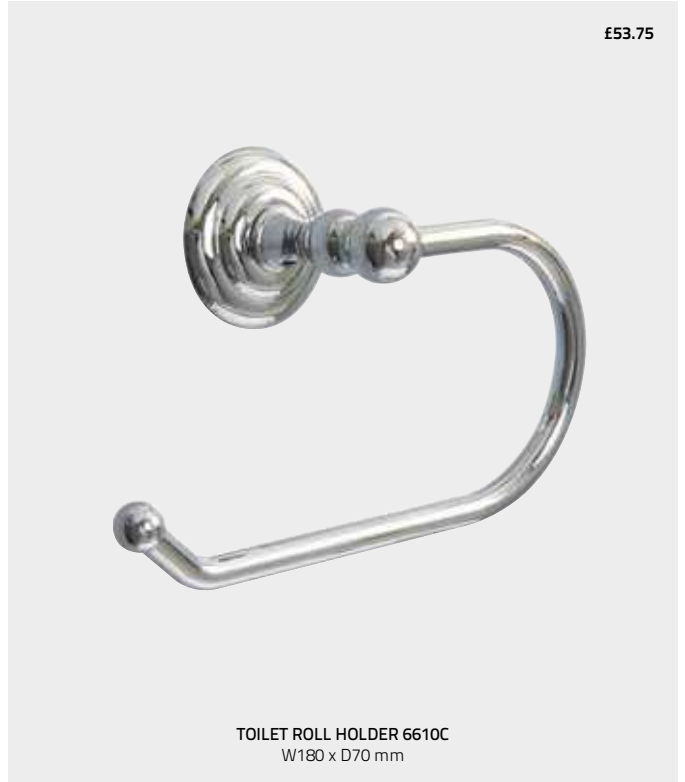

TOILET ROLL HOLDER 6610C
W180 x D70 mm



£59

TUMBLER HOLDER 6603C
White ceramic
H110 x D120 mm



£92.25

DOUBLE POST TOILET ROLL HOLDER 6637C
W220 x D70 mm



£59

SOAP DISH 6604C
White ceramic
H65 x D140 mm



Screws are included. This collection can also be fixed with our Fixing Adhesive.

We recommend that towel rails, glass shelves, mirrors, toilet brush sets, grab bars and products that carry heavy weight are screw fixed.



Lifetime Guarantee

Read more about the Miller Way on www.millerbathrooms.co.uk



'Full-fix 'anti twist' is a fixing system which prevents the accessory from turning when fitted.

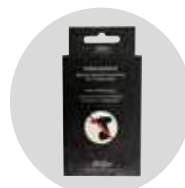

Fixing Adhesive £16
Fixing Adhesive code no. 8798
Glue always sold separately.
Read more on millerbathrooms.co.uk

LEARN MORE

For detailed measurements please see www.millerbathrooms.co.uk

Find more matching items within the Classic Collection. Page 44.

£36.50



SINGLE HOOK 6622C
D80 mm

£53.75



TOWEL RING 6605C
Ø155 x D70 mm

£47.25



DOUBLE HOOK 6623C
W85 x D70 mm

£92.25



TOWEL RAIL 6606C
L495 x D70 mm Length of rail 425 mm

£158



DOUBLE TOWEL RAIL 6627C
L655 x D150 mm

£97.75



TOWEL RAIL 6616C
L655 x D70 mm Length of rail 575 mm

£120.75



MIRROR 6600C
Bevelled edge,
W410 x H500 mm
Range mirror is guaranteed for 2 years.

£141.75



GLASS SHELF 6602C
Clear hardened glass
L500 x D125 x H56 mm

STOCKHOLM

Designed and developed in 1978, Stockholm is a timeless combination of classic quality and style. Crafted from solid brass and hand finished, this traditional collection is complimented by ceramic component parts. With its extensive range of items, Stockholm offers the perfect answer for any bathroom setting.



This collection is screwfixed.
Screws are included



Lifetime Guarantee

Read more about
the Miller Way on
www.millerbathrooms.co.uk

LEARN MORE

For detailed measurements
please see www.millerbathrooms.co.uk

Find more matching items
within the Classic Collection. Page 44.

Solid brass in chrome finish.
White ceramic details.

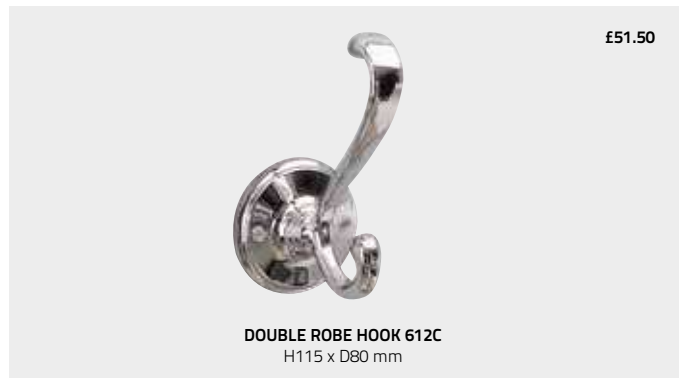
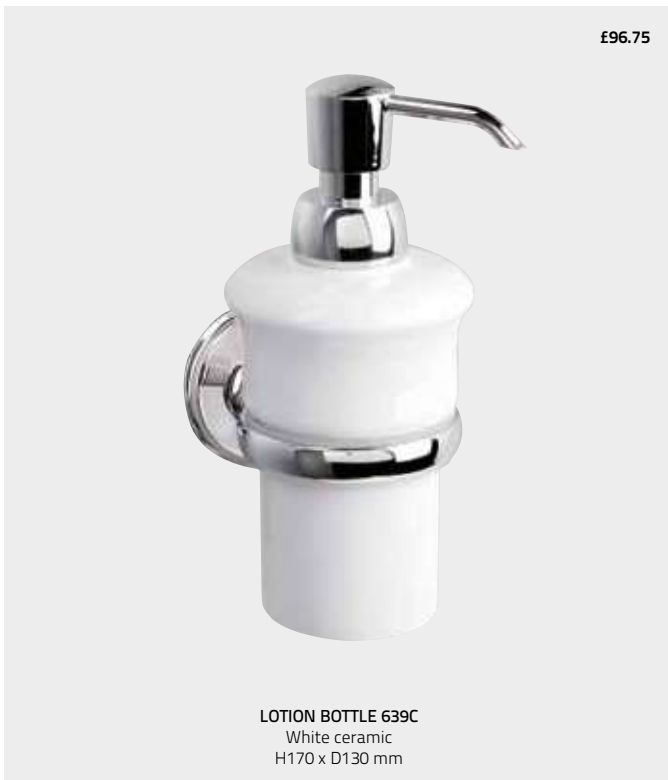
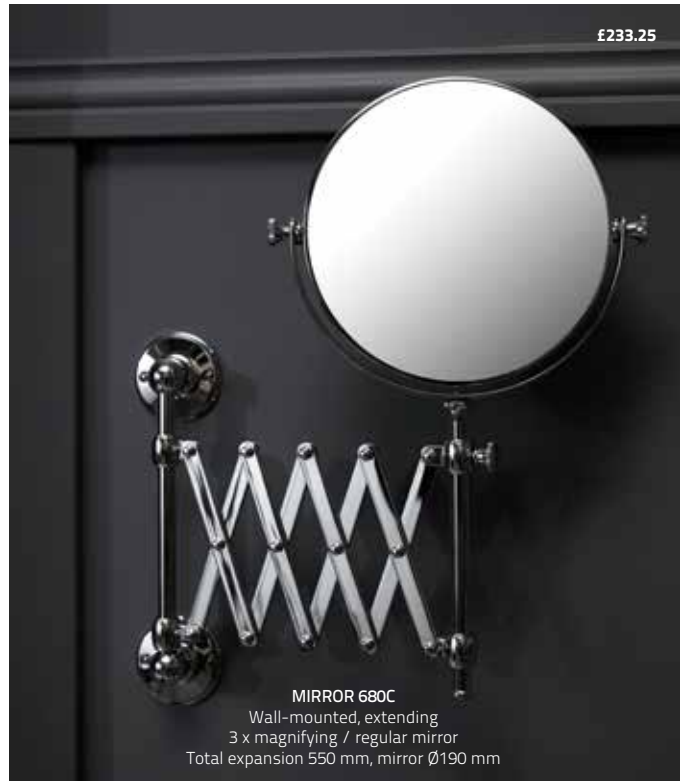
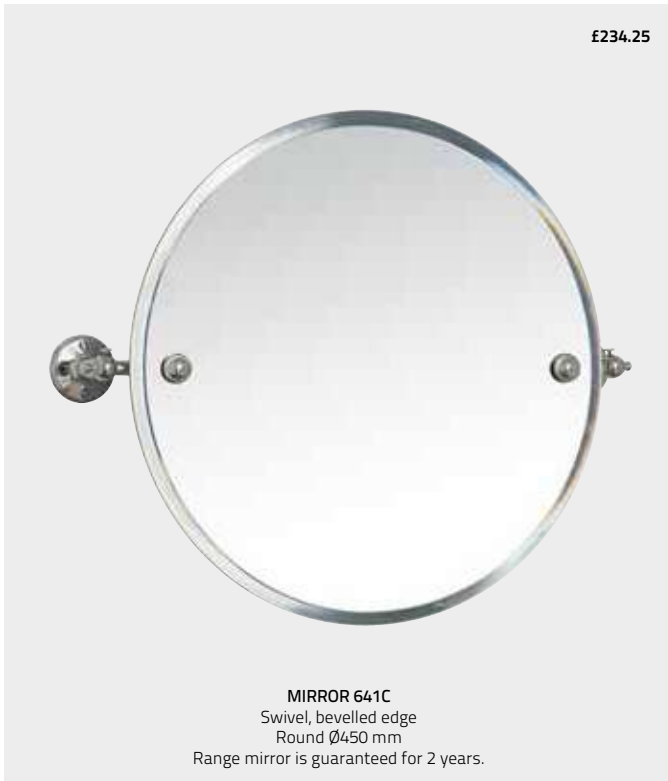

STOCKHOLM



£60

TOWEL RING 605C
Ø145 mm



£199.50

DOUBLE TOWEL RAIL 627C
L720 x H135 mm

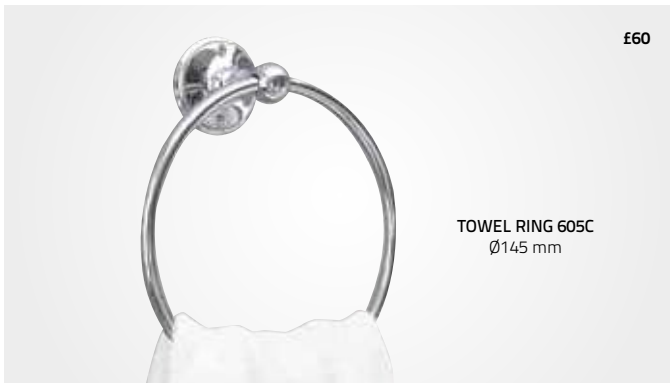

£179.50

DOUBLE TOWEL RAIL 617C
L545 x H135 mm



£95.50

TOWEL RAIL 606C
L545 x H75 mm



£166.50

SHELF 602C
Clear glass with chrome rail
L500 x D150 mm



£18.25

TOILET SIGN 722C
Oval sign, chrome finish
W80 x H45 mm



£18.25

BATHROOM SIGN 723C
Oval sign, chrome finish
W80 x H45 mm



£334.25



MIRROR 642C
Framed swivel, polished bevelling, chrome finish
W545 x H610 mm



£108.50



WALL HUNG TOILET BRUSH SET 628C
White ceramic
Ø110 x H400 mm



CLASSIC

The Classic Accessory Collection is a select range of creative and practical products. Designed and developed with careful attention to detail, this diverse collection offers solutions in a stylish and thoughtful way.



Screws are included. Products with this symbol can also be fixed with our Fixing Adhesive.

We recommend that towel rails, glass shelves, mirrors, toilet brush sets, grab bars and products that carry heavy weight are screw fixed.



10 year Guarantee

Read more about the Miller Way on www.millerbathrooms.co.uk

LEARN MORE

For detailed measurements please see www.millerbathrooms.co.uk

£233.25



MIRROR 680C

Wall mounted, 3 x magnification/regular mirror
Max extension 550 mm, Ø190 mm

£118.25



MIRROR 681C

Wall mounted, 3 x magnification/regular mirror
Max extension 350 mm, Ø190 mm

£174



TABLE MIRROR 688C

Polished bevelling. One-sided mirror
W279 x D130 x H340 mm

£82.75



MIRROR 27201C

Wall mounted, 3 x magnification
/regular mirror
Ø190 mm

£149.25



MIRROR 8781C

Wall mounted, 3 x magnification/regular mirror
Maximum extension 350 mm, Ø190 mm

£118.25



MIRROR 682C

3 x magnification/regular mirror
H405 mm, Ø190 mm

CLASSIC

Introducing new colours: Stainless Steel finish and Brushed Brass.

**GLASS SHELF x 4 LENGTHS: 300, 400, 500, 600 MM
x 5 FINISHES**

8 mm clear hardened glass
Solid brass bracket
Bracket measurement L150 x H25 x D30 mm
Depth of shelf incl. bracket 120 mm

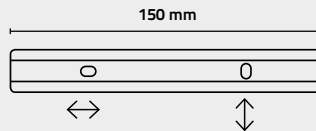

Screw holes in the bracket for easy adjustable fixing

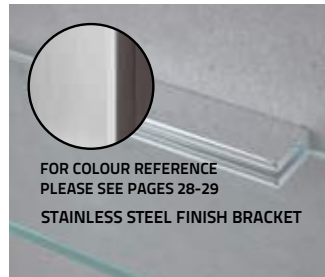

Total £100.75



GLASS SHELF 300 MM 810230 £30
BRACKET 8102MP £70.75
L300 mm
POLISHED UNTREATED BRASS

Total £105.50



GLASS SHELF 400 MM 810240 £34.75
BRACKET 8102MP £70.75
L400 mm
POLISHED UNTREATED BRASS

Total £113.75



GLASS SHELF 500 MM 810250 £43
BRACKET 8102MP £70.75
L500 mm
POLISHED UNTREATED BRASS

Total £119



GLASS SHELF 600 MM 810260 £48.25
BRACKET 8102MP £70.75
L600 mm
POLISHED UNTREATED BRASS

Total £99.75



GLASS SHELF 300 MM 810230 £30
BRACKET 8102B £69.75
L300 mm
MATT BLACK

Total £104.50



GLASS SHELF 400 MM 810240 £34.75
BRACKET 8102B £69.75
L400 mm
MATT BLACK

Total £112.75



GLASS SHELF 500 MM 810250 £43
BRACKET 8102B £69.75
L500 mm
MATT BLACK

Total £118



GLASS SHELF 600 MM 810260 £48.25
BRACKET 8102B £69.75
L600 mm
MATT BLACK

Total £99.75



GLASS SHELF 300 MM 810230 £30
BRACKET 8102MP1 £69.75
L300 mm
BRUSHED BRASS

Total £104.50



GLASS SHELF 400 MM 810240 £34.75
BRACKET 8102MP1 £69.75
L400 mm
BRUSHED BRASS

Total £112.75



GLASS SHELF 500 MM 810250 £43
BRACKET 8102MP1 £69.75
L500 mm
BRUSHED BRASS

Total £118



GLASS SHELF 600 MM 810260 £48.25
BRACKET 8102MP1 £69.75
L600 mm
BRUSHED BRASS

Total £99.75



GLASS SHELF 300 MM 810230 £30
BRACKET 8102BN £69.75
L300 mm
STAINLESS STEEL FINISH

Total £104.50



GLASS SHELF 400 MM 810240 £34.75
BRACKET 8102BN £69.75
L400 mm
STAINLESS STEEL FINISH

Total £112.75



GLASS SHELF 500 MM 810250 £43
BRACKET 8102BN £69.75
L500 mm
STAINLESS STEEL FINISH

Total £118



GLASS SHELF 600 MM 810260 £48.25
BRACKET 8102BN £69.75
L600 mm
STAINLESS STEEL FINISH

GLASS SHELF
8 mm hardened clear glass, 2 chrome finished shelf brackets.
Depth of all shelves 114 mm.

291020 L300 mm	£55.25
291120 L400 mm	£57.50
291220 L450 mm	£58.50
291320 L500 mm	£59.50
291420 L600 mm	£61.75



£59



CORNER SHELF 292320
8 mm hardened glass, 2 chrome finished shelf brackets
W200 x D200 mm

£60



CORNER SHELF 292020
8 mm hardened glass, 2 chrome finished shelf brackets
W200 x D114 mm

£106.25



CLOAKROOM SHELF 668C
6 mm hardened glass
Guard rail in chrome finish
W280 x D145 x H45 mm

CLASSIC



£135.25



PAPER ROLL HOLDER 5658MP1
With lid, Brushed Brass finish
Ø190 x H610 mm

£89



SPARE ROLL HOLDER 5659MP1
Fits 3 rolls, Brushed Brass finish
Ø130 x H480 mm

£118.25



TOILET BRUSH HOLDER 5638MP1
Free Standing
Ceramic Bowl / Brushed Brass finish
Ø130 x H480 mm

£107.50



TOILET BRUSH HOLDER 5638C
Free Standing
Ceramic Bowl / Chrome finish
Ø130 x H480 mm

£84.75



PAPER ROLL HOLDER 5651CH
Chrome finish / clear acrylic
H570 mm
Base 135 x 200 mm

CLASSIC

£253.50



TOWEL RACK 667B
Wall mounted, one towel rail, Black finish
L620 x D235 x H185 mm

£265.50

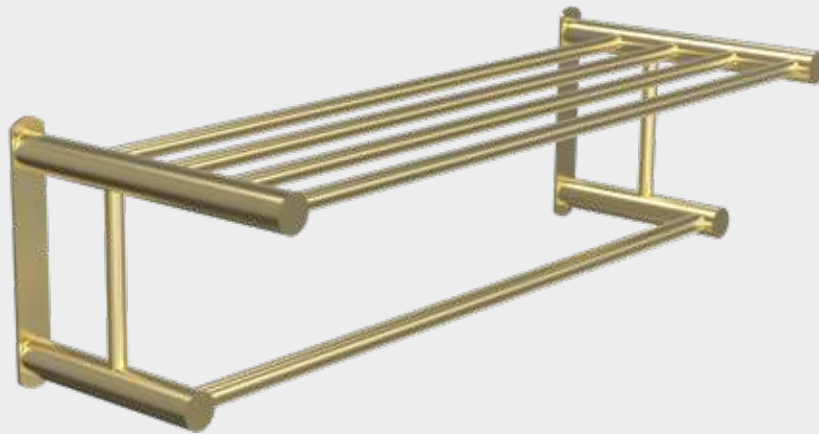

TOWEL RACK 667MP1
Wall mounted, one towel rail, Brushed Brass finish
L620 x D235 x H185 mm

£238.50

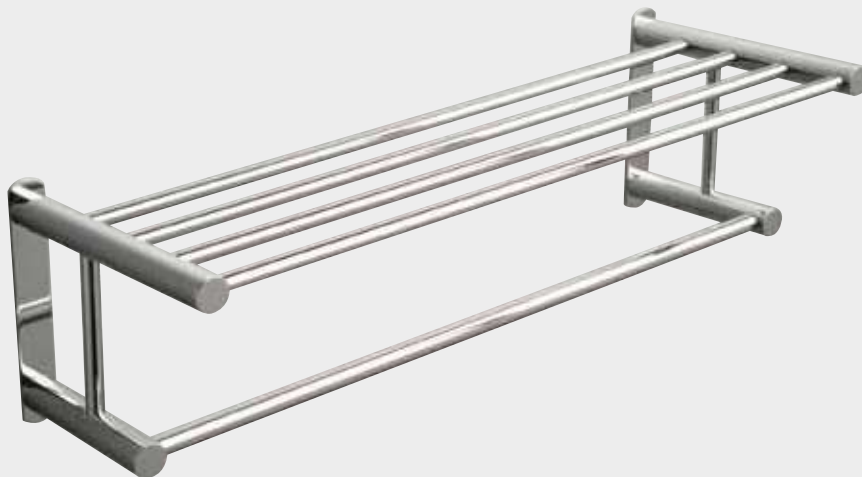

TOWEL RACK 667C
Wall mounted, one towel rail, Chrome finish
L620 x D235 x H185 mm



GRAB BAR

Concealed fixing Ø25 mm

- 5670C** L360 mm Chrome finish **£84.75**
- 5670B** L360 mm Matt Black finish **£92.25**
- 5670MP1** L360 mm Brushed Brass finish **£95.50**
- 5671C** L460 mm Chrome finish **£91.25**
- 5672C** L560 mm Chrome finish **£96.75**



£142.75

GRAB BAR 5675CH

Angled grab bar with basket. Reversible.
Concealed fixing Ø25 mm, chrome finish.
L460 x H220 x D125 mm



FOUR TIER SHELF 27054



£191.25

BATH RACK 662C

Chrome finish with white rubber details
W720 mm expand to 940 mm x D200 mm



£18.25

BATHROOM SIGN 723C

Oval sign, chrome finish
W80 x H45 mm



£18.25

TOILET SIGN 722C

Oval sign, chrome finish
W80 x H45 mm



£483.75

FOUR TIER SHELF 27054

4 clear glass shelves. Chrome finish
W350 H990 D280 mm



£58

SHOWER DOOR & SCREEN FITTING 4-HOOK 832B
 Matt Black finish
 Suitable for glass thickness up to 10 mm
 L181 x D50 x H30 mm



£54.75

SHOWER DOOR & SCREEN FITTING 4-HOOK 832C
 Chrome finish
 Suitable for glass thickness up to 10 mm
 L181 x D50 x H30 mm



£112.75



Parts included



Bracket with supplied tape



When mounted on a wall the holder angles outwards



FREE STANDING OR WALL HUNG
 (removable)

TOILET BRUSH SET 648B

Fix with screws or supplied tape. Spare Brush Head incl.
 Matt Black finish
 Ø85 x H380 mm



£134.25



PAPER AND SPARE ROLL HOLDER 5656B

Matt Black finish (Chrome Hinge)
 H568 mm
 Floor plate W200 x D135 mm



£92.25

GRAB BAR 5670B

Concealed fixing Ø25 mm, Matt Black Finish
 L360 mm Matt Black finish

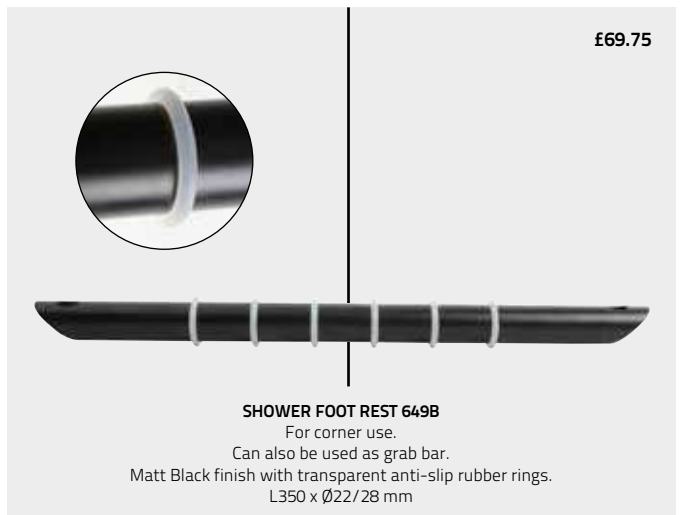

£69.75

SHOWER FOOT REST 649B

For corner use.
 Can also be used as grab bar.
 Matt Black finish with transparent anti-slip rubber rings.
 L350 x Ø22/28 mm



£104.25

Parts included
(image show 648B)

Bracket with
supplied tape
(image show 648B)

When mounted on
a wall the holder
angles outwards

FREE STANDING OR WALL HUNG
(removable)
TOILET BRUSH SET 648C
Fix with screws or supplied tape. Spare Brush Head incl.
Chrome finish
Ø85 x H380 mm



£183.75

FOLDING TOWEL HOLDER 5668CH
Free standing
W545 x H760 x D415 mm



£317

TOWEL HORSE 646C
Free standing
W670 x D290 x H900 mm



£222.50

TOWEL HOLDER 5669CH
Free standing, Base 180 x 245 mm
Total W373 mm Total H860 mm

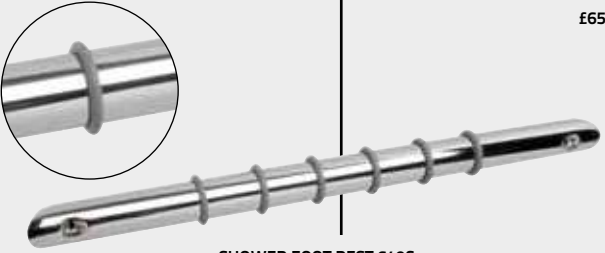

£65.50

SHOWER FOOT REST 649C
For corner use.
Can also be used as grab bar.
Chrome with transparent anti-slip rubber rings.
L350 x Ø22/28 mm

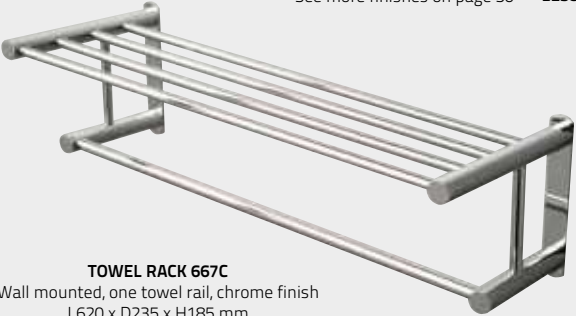

See more finishes on page 50 **£238.50**

TOWEL RACK 667C
Wall mounted, one towel rail, chrome finish
L620 x D235 x H185 mm

BASKETS

All baskets on this page have concealed screw fixings.
Baskets marked with no-drill symbol can be fixed with our fixing adhesive.
Adhesive is always sold separately, code.no. 8798

The Basket Collection is the pinnacle of luxurious showering accessories. We have selected the very best material to craft our wall mounted baskets, which all feature innovative, concealed fixings. Other features include a practical hook on some, while on others you will be able to remove them

for easy cleaning. Contemporary shower shelves add sophistication to the wet room environment, so popular today.

Our latest addition to this family of products are the 856 and 866 shower baskets that are gluable. Available in several finishes.



£94.50

D-SHAPED BASKET 866CG
(GLUABLE WALL BRACKETS 2-PACK INCLUDED WITH CHROME BASKET 866CG)
CHROME FINISH

Suitable for straight wall application, With practical hook
W250 x H80 x D125 mm



£89.75

SCREW FIXED D-SHAPED BASKET 866C
CHROME FINISH

Suitable for straight wall application
With practical hook
W250 x H80 x D120 mm

£96.75

D-SHAPED BASKET 866B
GLUABLE WALL BRACKETS 2-PACK BG1 **£9.50**

Suitable for straight wall application, With practical hook
W250 x H80 x D125 mm
MATT BLACK FINISH



£96.75

SCREW FIXED D-SHAPED BASKET 866B
MATT BLACK FINISH

Suitable for straight wall application
With practical hook
W250 x H80 x D120 mm

Polished Untreated Brass with a living surface. Beautiful patina is created over time.

£98.75

D-SHAPED BASKET 866MP
GLUABLE WALL BRACKETS 2-PACK MPG1 **£9.50**

Suitable for straight wall application, With practical hook
W250 x H80 x D125 mm
POLISHED UNTREATED BRASS



Polished Untreated Brass with a living surface. Beautiful patina is created over time.

£98.75

SCREW FIXED D-SHAPED BASKET 866MP
POLISHED UNTREATED BRASS

Suitable for straight wall application
With practical hook
W250 x H80 x D120 mm

GLUE/FIXING ADHESIVE 8798 £16

Use our adhesive to fix the baskets 856-, 866- with wall brackets. Fixes 2-4 back plates.



All baskets on this page have concealed screw fixings.
 Baskets marked with no-drill symbol can be fixed with our fixing adhesive.
 Adhesive is always sold separately, code.no. 8798



£94.50

GLUABLE CORNER BASKET 856CG
 (GLUABLE WALL BRACKETS 2-PACK INCLUDED WITH CHROME BASKET 856CG)
CHROME FINISH
 With practical hook
 W235 x H80 x D175 mm



£89.75

SCREW FIXED CORNER BASKET 856C CHROME
 With practical hook
 W235 x H80 x D175 mm



£96.75
£9.50

GLUABLE CORNER BASKET 856B
GLUABLE WALL BRACKETS 2-PACK BG1
 With practical hook
 W235 x H80 x D175 mm
MATT BLACK FINISH



£96.75

SCREW FIXED CORNER BASKET 856B MATT BLACK FINISH
 With practical hook
 W235 x H80 x D175 mm



Polished Untreated Brass with a living surface. Beautiful patina is created over time.

£98.75
£9.50

GLUABLE CORNER BASKET 856MP
GLUABLE WALL BRACKETS 2-PACK MPG1
 With practical hook
 W235 x H80 x D175 mm
POLISHED UNTREATED BRASS

£98.75

Polished Untreated Brass with a living surface. Beautiful patina is created over time.

SCREW FIXED CORNER BASKET 856MP POLISHED UNTREATED BRASS
 With practical hook
 W235 x H80 x D175 mm



£98.75
£9.50

GLUABLE CORNER BASKET 856MP1
GLUABLE WALL BRACKETS 2-PACK MP1G1
 With practical hook
 W235 x H80 x D175 mm
BRUSHED LACQUERED BRASS

£98.75

SCREW FIXED CORNER BASKET 856MP1 BRUSHED LACQUERED BRASS
 With practical hook
 W235 x H80 x D175 mm

BASKETS

All baskets on this page have concealed screw fixings.

£68.25



CORNER SOAP BASKET 851C
 Chrome finish
 With practical hook
 W185 x H35 x D130 mm

£174



CORNER BASKET 855C
 Two tier
 Chrome finish
 With practical hook
 W235 x H310 x D175 mm

£196.50



CORNER BASKET 855MP1 Two tier
 Brushed Brass finish
 With practical hook
 W235 x H310 x D175 mm

£190.25



CORNER BASKET 855B Two tier
 Matt Black finish
 With practical hook
 W235 x H310 x D175 mm

£165.50



D-SHAPED BASKET 865C
 Chrome finish
 Suitable for straight wall application, two tier
 With practical hook
 W250 x H310 x D120 mm

£268.75



SHOWER CADDY 663C
 Chrome finish
 Two tier. No fixing needed.
 W235 x H650 x D125 mm
 Height of baskets 80 mm

All baskets on this page have concealed screw fixings.



£98.75

RECTANGULAR SHOWER TIDY 877C
Removable tray. Dishwasher tested.
W233 x H60 x D125 mm



£98.75

CORNER SHOWER TIDY 876C
Removable tray. Dishwasher tested.
W230 x H60 x D175 mm



£184.75

TWO TIER CORNER SHOWER TIDY 878C
Removable tray. Dishwasher tested.
W230 x H310 x D175 mm



£328.75

CORNER SHOWER BASKET 875C
Three tier
With practical hook
W235 x H540 x D175 mm
Height of baskets 80 mm



£165.50

CORNER SHOWER SHELF 864C
Angled. Practical hook.
W250 x H70 x D200 mm



OVAL BASKET
Suitable for straight wall application, removable for easy cleaning

867C W280 x H55 x D105 mm **£95.50**
868C W350 x H70 x D130 mm **£107.50**

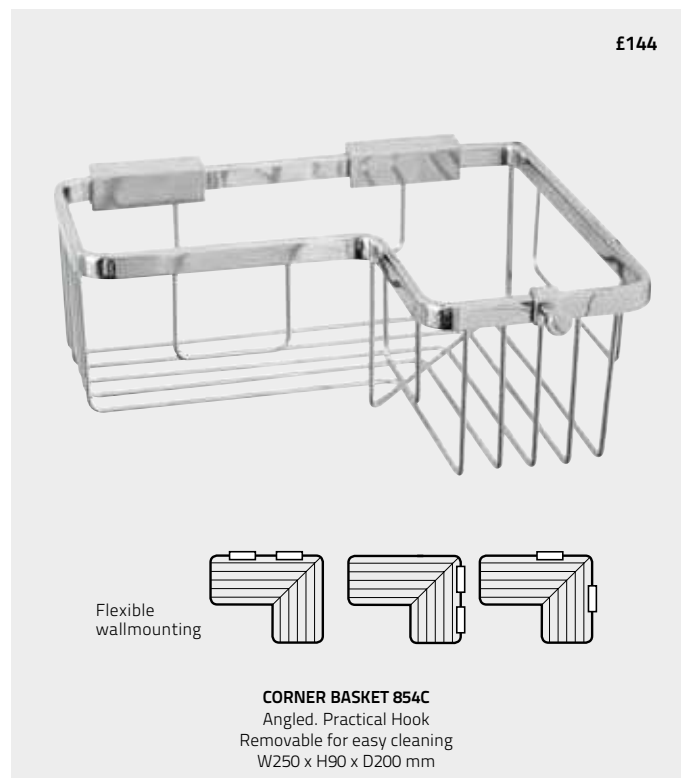

£144

Flexible wallmounting

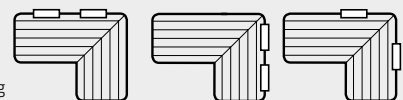

CORNER BASKET 854C
Angled. Practical Hook
Removable for easy cleaning
W250 x H90 x D200 mm

BASKETS

All baskets on this page have concealed screw fixings.
Baskets marked with no-drill symbol can be fixed with our fixing adhesive.
Adhesive is always sold separately, code.no. 8798



All baskets on this page have concealed screw fixings.



BASKETS

All baskets on this page have concealed screw fixings.



All baskets on this page have concealed screw fixings.



CLASSIC



CORNER BASKET 654C £77.25

Two tier, brass, chrome finish
W175 x D115 x H210 mm

CORNER BASKET 655C £104.25

Two tier, brass, chrome finish
W250 x D150 x H310 mm

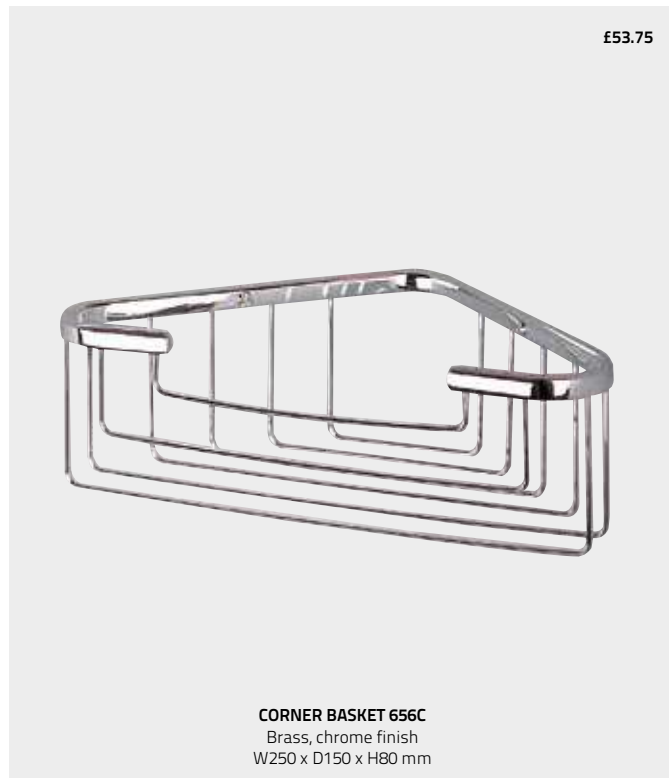

£53.75

CORNER BASKET 656C

Brass, chrome finish
W250 x D150 x H80 mm



£35.25

SOAP BASKET 650C

Brass, chrome finish
W130 x D95 x H35 mm



£35.25

CORNER BASKET 651C

Brass, chrome finish
W175 x D115 x H35 mm



£46

CORNER BASKET 652C

Brass, chrome finish
W250 x D150 x H55 mm

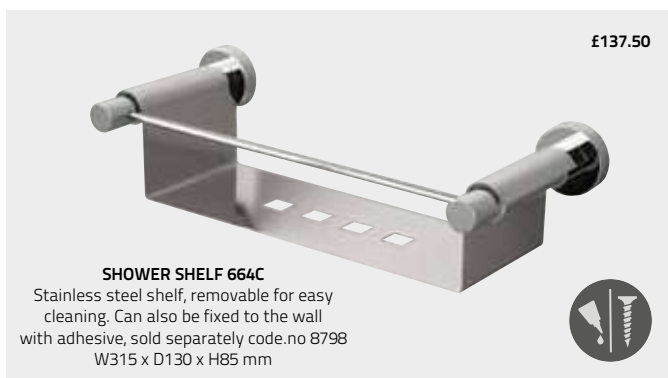

£137.50

SHOWER SHELF 664C

Stainless steel shelf, removable for easy cleaning. Can also be fixed to the wall with adhesive, sold separately code.no 8798
W315 x D130 x H85 mm



£70.75

BASKET 653C

Brass, chrome finish
W265 x D125 x H45 mm

CLASSIC LIGHT PULL

Classic accessories packaging can be easily found through this colour.

The Classic Light Pull Collection is both stylish yet practical. Manufactured from solid brass with several items featuring complimentary ceramic or wood parts, all these pulls are supplied with white cord for easy fitting.

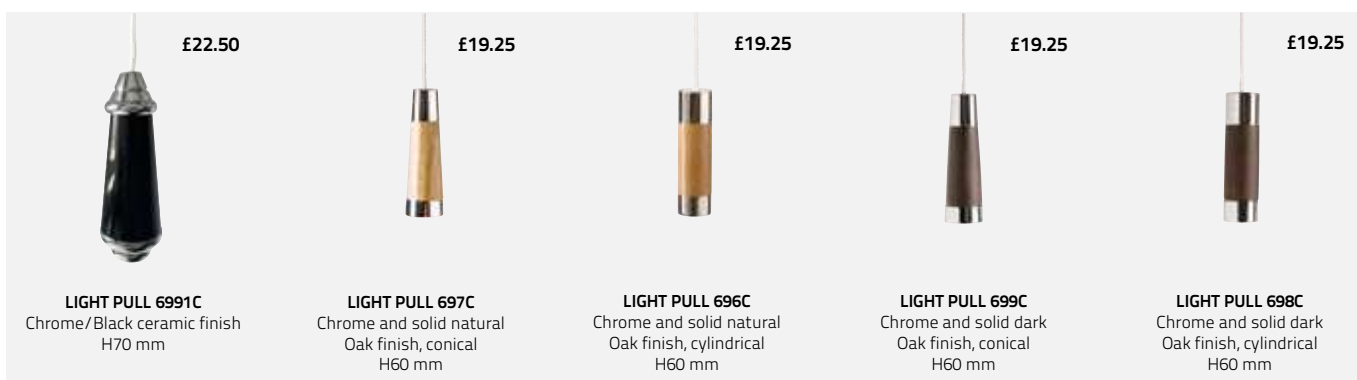
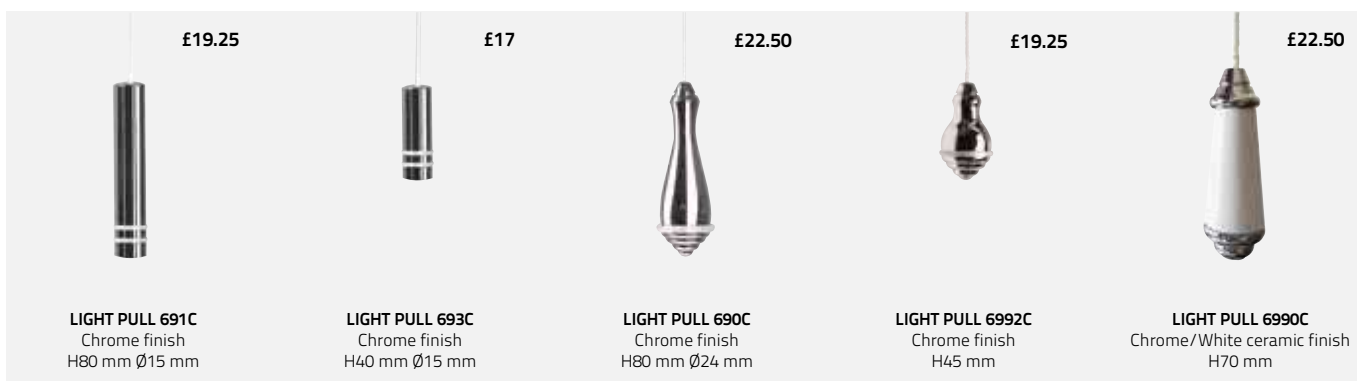

CUBE

Backplate 60 x 60 mm, Chrome finish



Glass Shelf C02
Clear Glass
L500 x D140 mm

£47.75



Soap Dish C04
Clear glass
H60 x D130 mm

£24.50



Lotion Bottle C34
Frosted glass
H160 x D110 mm

£34.25



Tumbler Holder C03
Clear glass
H110 x D110 mm

£24.50



Towel Ring C05
Ø155 mm
H180 x D55 mm

£23.50



Double Hook C23
D55 mm

£19.25



Towel Rail C06
Length of rail 430 mm
L505 x D70 mm

£37.50



Single Robe Hook C11
D55 mm

£17



Toilet Roll Holder C10
W170 x H110 mm

£23.50



Screws are included.
This collection can also be fixed with our Fixing Adhesive.

We recommend that towel rails, glass shelves, mirrors, toilet brush sets, grab bars and products that carry heavy weight are screw fixed.



2 year Guarantee

Read more about the Miller Way on www.millerbathrooms.co.uk

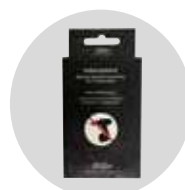

Fixing Adhesive £16
Fixing Adhesive code no. 8798
Glue always sold separately.
Read more on millerbathrooms.co.uk

LEARN MORE

Find more matching items within the Classic Collection. Page 44.

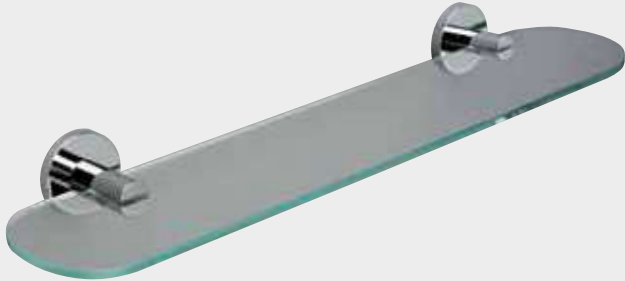

Glass Shelf L02
Clear Glass
L500 x D125 mm

£46.75



Soap Dish L04
Clear glass, Ø110 mm
H60 x D130 mm

£24.50



Lotion Bottle L34
Frosted glass
H170 x D110 mm

£33.25



Tumbler Holder L03
Clear glass
H95 x D105 mm

£24.50



Towel Ring L05
Ø160 mm

£22.50



Double Hook L23
H60 x D55 mm

£18.25



Towel Rail L06
L520 mm

£36.50



Hook L11
H60 x D55 mm

£16



Toilet Roll Holder L10
W170 x H110 mm

£22.50



Screws are included.
This collection can also be fixed with our Fixing Adhesive.

We recommend that towel rails, glass shelves, mirrors, toilet brush sets, grab bars and products that carry heavy weight are screw fixed.



2 year Guarantee

Read more about the Miller Way on www.millerbathrooms.co.uk

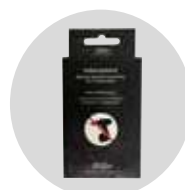

Fixing Adhesive £16
Fixing Adhesive code no. 8798
Glue always sold separately.
Read more on millerbathrooms.co.uk

LEARN MORE

Find more matching items within the Classic Collection. Page 44.

A good morning. And an equally good night.

The morning is full of anticipation. At night it is filled by a relaxing calm. The bathroom has an important role for all - for both the large and the small family. Therefore it is important that the bathroom spreads that extra feeling of comfort that makes us feel good.

But we are all unique, with different tastes and needs and desire a bathroom that is adapted to our own personality. Freedom of choice from our wide range of bathroom furniture and accessories gives you the chance to realise your own dreams.



City 78

Available in 6 on-trend colours- we invite you to choose yours, built to last a lifetime. A silky smooth feel combined with a resistant matt surface make the furniture a more interesting and sustainable choice.



Kensington 94

Soft bevelled edges and beautifully framed fronts. Kensington combines classic elegant furniture with modern storage and basin possibilities. Modern beauty for a long lasting fine bathroom.



Traditional 1903 136

Back to beauty. The classic design creates a safe and warm feeling for your moments in the bathroom. Hand-worked details and rounded arches along the classic English washbasin provide a luxurious and romantic feel to everyday life.



New York 106
Smooth doors and drawers.



London 118
Framed doors and drawers.



Ceramic 142 **Taps 145**



Mirrors and Mirrored Cabinets 128

- 78** City
- 94** Kensington
- 106** New York
- 118** London
- 128** Mirrors and Mirrored Cabinets
- 136** Traditional 1903
- 142** Ceramics
- 145** Taps
- 147** Handles and Knobs



Material, Care and Fixing Guides
Can be found at www.millerbathrooms.co.uk

Higher standard Guaranteed

It's difficult to explain the feeling, when something feels really good inside and out. We constantly work on improving the small details which ultimately makes our bathroom furniture better.

Details that might not always be visible but after years of use the feeling becomes obvious. Miller offers a guaranteed higher standard without adding extra. Room for feelings – the Miller Way.



Open and close to feel the quality. We use only the best rails and fittings with our furniture.



Edges and fronts of both drawers and doors are of 19 mm thickness. This gives a solid and longer lasting impression.



Mirror Cabinets and Mirrors in several sizes with efficient, elegant and dimmable LED lighting.



High drawers are equipped with a retaining bar that keeps tall bottles and for instance electric tooth brushes in place.



The hinges on the double sided mirror doors are fully adjustable in all directions and soft closing.



Genuine ceramic of highest quality. See page 12 for several options of full cover basins.



Conscious choices of material give you a sustainable product with the best finish.



Fully extendable, soft closing drawers. Dividers made from solid oak. Anti-slip mats and straight insides gives you optimal storage.



Plenty of options for optimal storage.

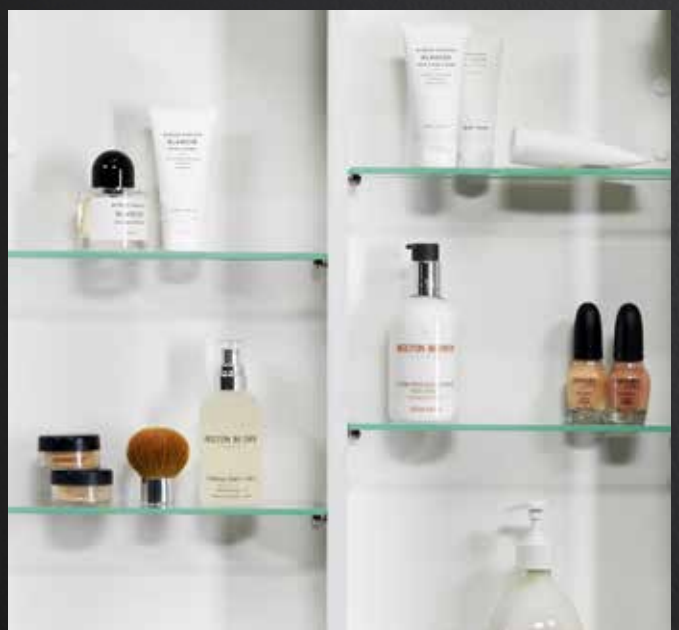

Centre divider in our bathroom cabinets gives stability and flexibility when it comes to the placement of the shelves.

Our innovative Collection City

Feel the surface- soft and smooth to the touch, fingerprint free and scratch proof. Made from an attractive, strong, high density material using the latest Nano-technology.

The surface density is the key to the colour, finish and strength of the new City range - both beautiful and sustainable.

Pictures only tell half the story for City, visit one of our displaying dealers to feel the difference. See for yourself the long lasting, colour fast, smooth finish.

Available in 6 on-trend colours- we invite you to choose yours, built to last a lifetime.

Durable. Dirt and water repellent. Light resistant. Silky smooth.

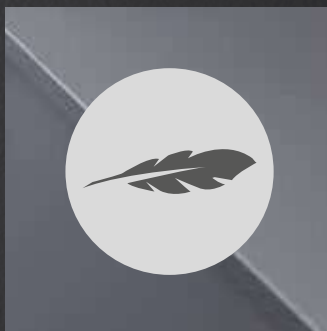

Smooth surface

Feel it – the silky-smooth surface is both nice to the touch and lovely to look at.

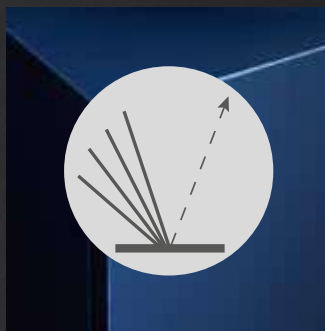

Matt surface

The matt surface reflects a minimum of light and creates a soft effect in your bathroom.

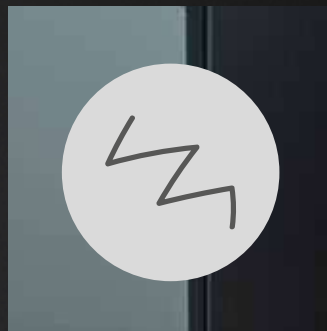

Scratch resistant material

The material surface offers the most scratch resistant surface Nano-technology can offer increased wear resistance offers longer use and sustainability



Anti-fingerprint

The special surface used is dirt and water repellent and fingerprint free.



New ceramic basins with a thin edge in 5 sizes.



Detail of Pebble Greige vanity with Stone Work top in Carrara Marble.

City Basins and Worktops

Full Cover Ceramic Basins



D-Shape



Rectangular



Velca



City

Stone Worktop with Integrated Ceramic Basin (Worktops A.)



134W/600X



134W/800X



134W/1000X

Basins for worktop, tap mounted on the basin (Worktops A.B.C.)



116W1



117W1



171W1



173W1

Basin for worktop, tap mounted on the work top (Worktops A.B.C.)



135W Ø33 cm



136W Ø39 cm



133W Ø39 cm



132W

Worktops: Stone, Limestone, Quartz and Wood

Stone Worktop 30 mm



Carrara Marble



Grey Granite



Black Diabase



Green Marble

Limestone 30 mm



Jura

Wood Worktop 18 mm



Classic White



Midnight Blue



Charcoal Black



Highland Green



Pebble Greige



Thunder Grey

Worktop Quartz Stone 20 mm



Royal Reef



Black Tebas

A brighter future starts in your bathroom

Linear LED is energy saving yet very powerful. The vertical lights reduce shadow casting and gives you the perfect mirror reflection.

The built in touch sensor enables you to control the amount of light you want – and thanks to the built in memory the Linear LED remembers your preference until next time it's turned on.

Functional, practical and beautiful – the thin LED light bars shine both forward and inward on the cabinets and making sure you have a bright time in the bathroom.

Miller



Centre divider in our bathroom cabinets gives stability and flexibility when it comes to the placement of the shelves.

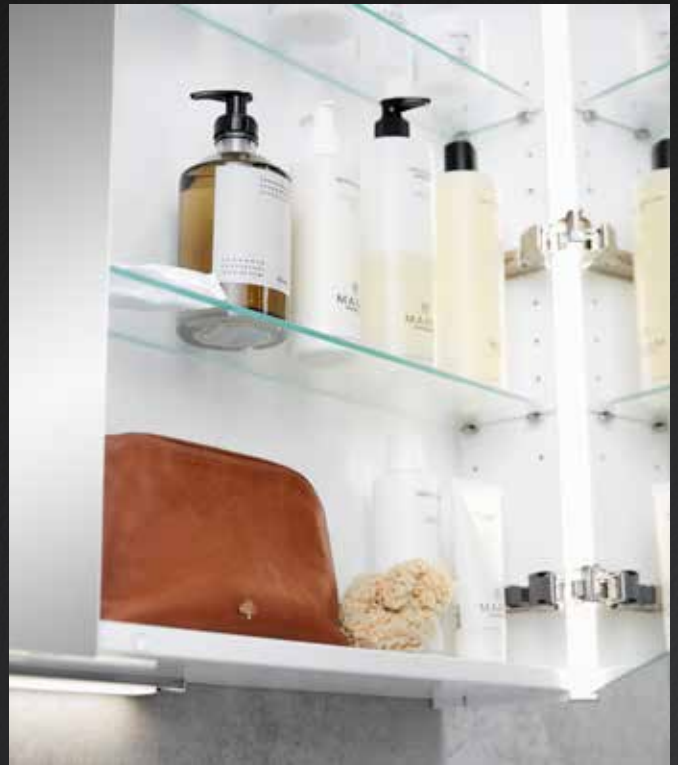

Technically powerful LED lighting creates bright lines with better colour reproduction. Perfect for makeup.



Down lighting is an option that provides an effective lighting over the basin.



The lighting is integrated into the cabinet sides and measures 16 mm x 16 mm.



Light shines both forward and inward on cabinets.



Control the brightness with a touch sensor. Linear LED remembers the last chosen setting/brightness when switched on and off.

Powerful beauty lasts longer

Select your personal expression for a brighter morning and evening. Our featured basin choices in ceramic are tailored to our vanity units in the City, Kensington, London and New York collections.

Full cover basins in 4 shapes in several sizes: 60, 80, 100, 120 and 160 cm. Comprehensive solutions for an individual bathroom.

Three taphole and no taphole solutions on all fullcover basins possible. Contact us for more information.



Three Taphole



No Taphole



Extended leadtime on request



60



80



100



120



160

City

Slim sleek modern design. City basins offers great counter top space. Approximately 105 mm bowl depth and 16 mm thin edge (height). Available in sizes 60, 80, 100, 120 and 160 cm.



60



80



100



120

D-Shape

One of our most popular basins because of the countertop and good bowl depth. The depth of the bowl is approximately 135 mm. Available in 60, 80, 100 and 120 cm.



60



80



100



120

Velca

A modern basin with an exciting design and a slightly higher ceramic edge. Wide countertop in the back, 120 mm and a deeper bowl - 135 mm. Available in 60, 80, 100 and 120 cm.



60



80



100



120

Rectangular

With clean lines and a stylish shape this basin give an exciting touch in the modern bathroom. Spacious countertop and a slightly more shallow bowl - 100 mm. Available in 60, 80, 100 and 120 cm.

Natural Stone Worktops

You can feel it with your fingers, and you see it with your eyes. A feeling of beauty that is sustainable for both the test of time - and your eyes desire. Choose your personal favourite from among our counter tops.

Solid Worktops with a slightly bevelled edge gives a beautiful finger-tip feeling finish. Worktops can be selected to complement City, Kensington, London and New York.

Carrara Marble

This classic marble from Italian Carrara has been a favourite among architects and sculptors since the Roman Empire's glory days. Charm, feel, style and classic beauty - and much more durable now thanks to our stone work tops water resistance.

Variation in appearance

Our stone worktops are made of genuine stone, which means that colour and texture vary from rock to rock. It helps you to create a natural and personal charm in your new bathroom. To make a durable surface, all of our worktops are treated.



Black Diabase

Diabase, or "black granite" as it is sometimes mistakenly called, can be seen in the black streaks in the mountains around Sweden. It is a dense and hard rock that stands up to everything. The satin black surface gives the bathroom a feeling of both luxury and pleasure.

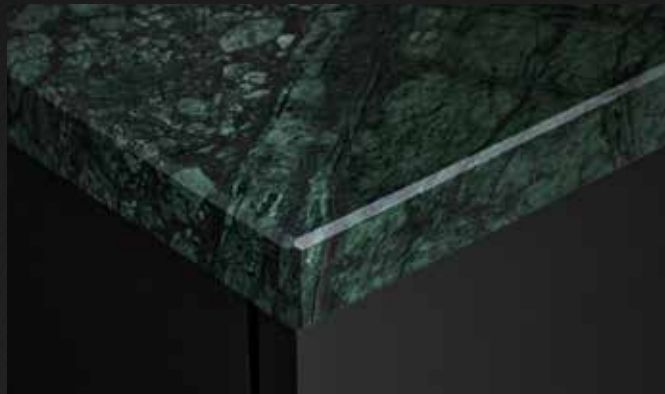

Green Marble

An alternative to the classic Carrara marble is our green marble which has recently become very popular. The deep green color with its speckled surface creates a nice contrast to our white ceramic basins.



Limestone Jura

Limestone is a beautiful living material that fits well in the bathroom. Irregular fossil elements in a beautiful natural beige tone fit several of our bathroom furniture.



Swedish Granite

Our beautiful grey Bohus granite comes from Bohuslän. There they have for centuries quarried the stone which is both durable and beautiful, because even if the granite is the most common rock type on earth, each stone is unique with its own grain and character. A natural beauty that lives a long time - for both your bathroom and life ...



Quartz Stone - Royal Reef
("limestone effect")



Quartz Stone - Black Tebas

Quartz Stone

'Silestone' quartz stone has a sophisticated look and feel along with the weight of natural stone. In many regards, it has a higher quality. It consists of up to 94% of natural quartz which is very resistant.

CITY

40, 60, 80, 100, 120 and 160 cm

Smooth doors and drawers

Silk matt surface



Feel the surface - soft and smooth to the touch, Fingerprint free and scratch proof. Made from an attractive, strong, high density material using the latest Nano-technology. The surface density is the key to the colour, finish and strength of the new City range - both beautiful and sustainable.

Pictures only tell half the story for City, visit one of our displaying dealers to feel the difference. See for yourself the long lasting, colour fast, smooth finish.

Available in 6 on-trend colours - we invite you to choose yours, built to last a lifetime.



Drawer Vanity City 160 Classic White with ceramic basin184W1. Tap 1940C. Linear Led Mirror Cabinet 80 x 2 pcs.



Double 160 cm vanity with 4 drawers and a lot of storage.
Big unloading space between the bowls.



Our City basins have a thin 16 mm ceramic edge.



Vanity 100 Midnight Blue with stone worktop carrara marble, basin 136W, tap 1941MP, handle 50884.



Drawer Vanity 80 Highland Green with full cover basin City 181W1. Thin ceramic only 16 mm. Tap 1942C. Handle 93798.



Drawer Vanity 100 Midnight Blue with stone worktop in carrara marble. Basin 136W, tap 1941MP, linear led mirror cabinet 755L-3 with down light DL2. Tall Cabinet 795H-3. Accessories Classic and Bond.



Matching worktop. Thanks to the durable surface on our bathroom collection City we can now offer worktops.



From the left: **Highland Green door vanity 40 784H-6T**, worktop 779-6, basin 135W, tap 1941MP, linear led mirror 59L, knob 50886. **Midnight Blue door vanity 40 784H-3T**, worktop 779-3, basin 135W, tap 1941C, simple mirror glass 59-G+led lighting L102, knob 93810. **Thunder Grey door vanity 40 784H-9T**, worktop 400GM, basin 174W1, tap 1940B, linear led mirror cabinet 752HL-9, knob 50887. **Pebble Greige door vanity 40 784H-8T**, work top 400M, basin 174W1, tap 1940C, linear led mirror 59L, knob 95042. **Charcoal Black door vanity 40 784H-4T**, worktop 400J, basin 174W1, tap 1935C, linear led mirror cabinet 752HL-4, knob 50883.



Door Vanity 40 can vary in several ways. Combine with several different mirrors and mirror cabinets.



Drawer Vanity 80 Charcoal Black with full cover basin 181W1, tap 1940B, linear led mirror cabinet 754L-4 with down light DL2. Storage Cabinet 796H-4. Accessories Atlanta.

Soft closing drawers and doors. The drawers are sturdy, fully expandable and fitted with anti-slip mats. Vanity unit top drawers have compartments in solid oak that can be easily removed for cleaning. Vanity bottom drawers are fitted with an adjustable bar to stop larger items from moving.

Complete the look with our range of taps and handles to add your own finished character to the bathroom furniture.

The furniture is delivered fully assembled.

For your vanity you can choose between a full cover basin, stone worktop with integrated basin or a worktop with basin. See options below.

Colours

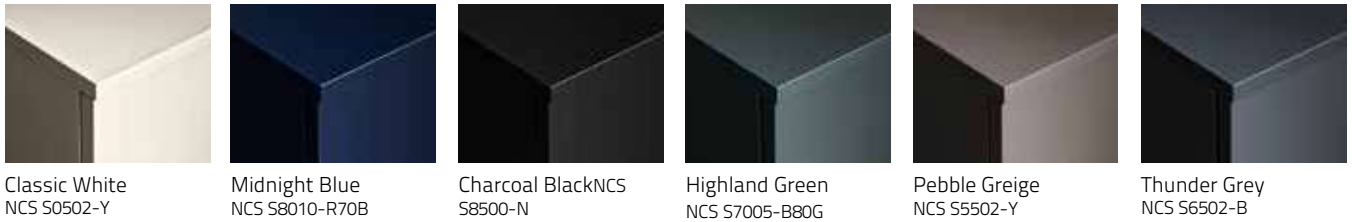

Drawer Vanities in five ways:

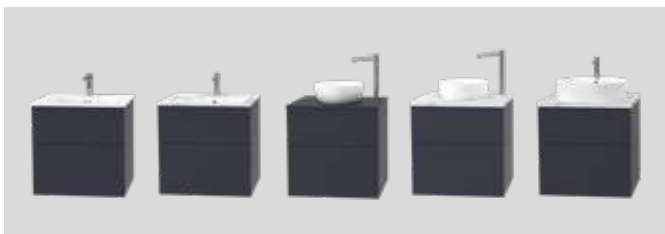

1. Drawer Vanity with full cover basin
2. Drawer Vanity with stone worktop and integrated ceramic basin
3. Drawer Vanity with wood worktop, basin and free standing tap
4. Drawer Vanity with stone worktop, basin and free standing tap
5. Drawer Vanity with worktop, basin and tap

Full Cover Ceramic Basins



Stone Worktop with Integrated Ceramic Basin



Basins for worktop, tap mounted on the basin



Basin for worktop, tap mounted on the work top



Door Vanities in two ways:

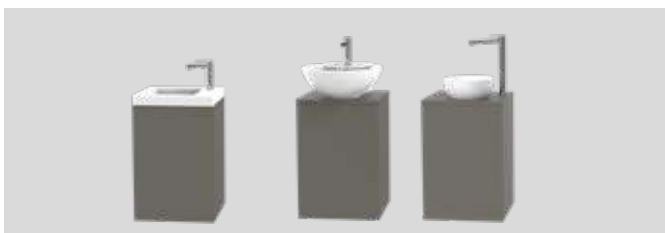

1. Door Vanity with full cover basin, only 35 cm deep
2. Door Vanity with worktop and basin

Stone Worktop 30 mm



Carrara Marble Grey Granite Black Diabase Green Marble

Worktop Quartz Stone 20 mm



Royal Reef Black Tebas

Limestone 30 mm



Jura

Wood Worktop 18 mm



Classic White Midnight Blue Charcoal Black



Highland Green Pebble Greige Thunder Grey

DETAILS CITY

Symbol shows that this feature is optional. **T**



Fully extendable, soft closing drawers. Lower vanity drawers are equipped with an adjustable retaining bar that keeps bottles in place.



Top Drawer is equipped with a removable divider in solid oak.



Anti slip mats in vanity units and storage cabinet drawers.



Pad. Drawer fronts and doors have partially milled pads in rubber that stays in place.



Linear Led Mirror Cabinets in matching City 6 colours.



Endless possibilities: Highland green vanity with Green Marble stone worktop and underglued ceramic basin.



Drawers have straight insides which allows you to take advantage of the entire surface.



Bathroom Cabinet are equipped with a centre divider in wood that gives a more flexible placement of the shelves.

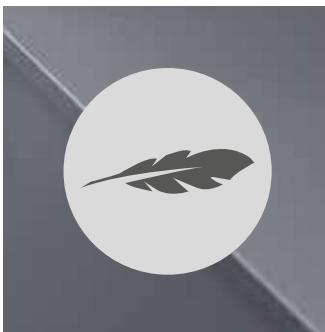

Smooth surface
Feel it – the silky-smooth surface is both nice to the touch and lovely to look at.

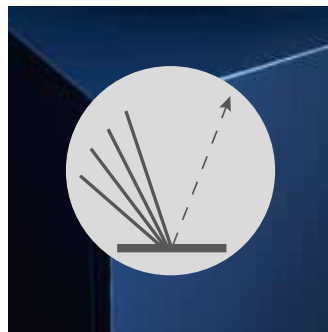

Matt surface
The matt surface reflects a minimum of light and creates a soft effect in your bathroom.

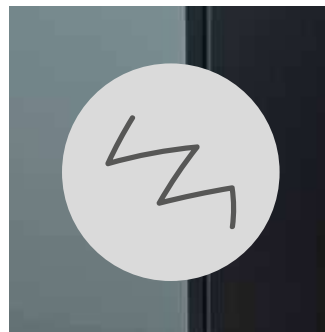

Scratch resistant material
The material surface offers the most scratch resistant surface Nano-technology can offer increased wear resistance offers longer use and sustainability.



Anti-fingerprint
The special surface used is dirt and water repellent and fingerprint free.



Our bathroom furniture has a 10 year guarantee.



Matching worktop. Thanks to the durable surface used in our City bathroom collection, we can now offer colour matched worktops.

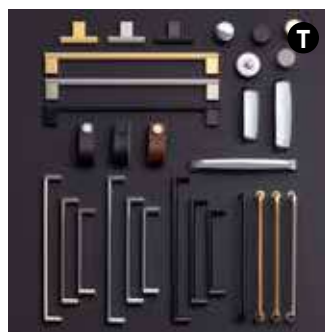

Handles and knobs. Choose between various finishes, shapes and sizes to create your personal touch. Page 147.



Taps. Choose a suitable and stylish favourite from our full range of taps. Page 145.

CITY

Vanity units are fitted with mounting rails and brackets for easy adjustment and quick installation. Drawer fronts are adjustable in all directions. Fully extending drawers with soft close mechanism.

The drawers include an anti slip mat and removable wooden dividers in solid oak.

Lower drawers in vanities are equipped with a retaining bar. Vanity units, basins, taps and handles are priced separately.

Choose between full cover basin, stone work top with integrated basin or work top with basin. All furniture is delivered fully assembled.

Read more about the Miller Way on www.millerbathrooms.co.uk



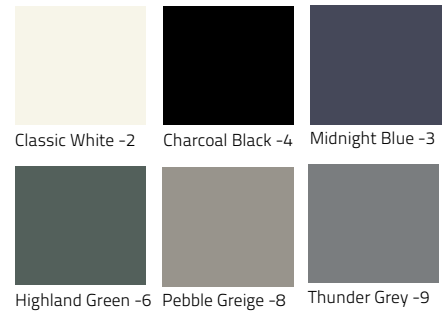













Colour



60 / 80 / 100 / 120 / 160

Vanity with full cover ceramic basin

Price separately for vanity, basin and tap. Images below shown with basin City.

<p>60 City</p>  <p>Size vanity W594 x H625 x D448 mm Basin size see each model below</p>	<p>80 City</p>  <p>Size vanity W 794 x H625 x D448 mm Basin size see each model below</p>	<p>100 City</p>  <p>Size vanity W994 x H625 x D448 mm Basin size see each model below</p>																																																									
<p><i>Vanity unit 2 drawers</i></p> <table border="0"> <tr><td>White</td><td>788-2</td><td rowspan="6">£975</td></tr> <tr><td>Blue</td><td>788-3</td></tr> <tr><td>Black</td><td>788-4</td></tr> <tr><td>Green</td><td>788-6</td></tr> <tr><td>Greige</td><td>788-8</td></tr> <tr><td>Grey</td><td>788-9</td></tr> </table> <p><i>Optional</i></p> <table border="0"> <tr><td>Push function</td><td>PTM-2</td><td>£175 / for 2 drawers</td></tr> <tr><td>Handles</td><td>page 147</td><td></td></tr> </table>	White	788-2	£975	Blue	788-3	Black	788-4	Green	788-6	Greige	788-8	Grey	788-9	Push function	PTM-2	£175 / for 2 drawers	Handles	page 147		<p><i>Vanity unit 2 drawers</i></p> <table border="0"> <tr><td>White</td><td>789-2</td><td rowspan="6">£995</td></tr> <tr><td>Blue</td><td>789-3</td></tr> <tr><td>Black</td><td>789-4</td></tr> <tr><td>Green</td><td>789-6</td></tr> <tr><td>Greige</td><td>789-8</td></tr> <tr><td>Grey</td><td>789-9</td></tr> </table> <p><i>Optional</i></p> <table border="0"> <tr><td>Push function</td><td>PTM-2</td><td>£175 / for 2 drawers</td></tr> <tr><td>Handles</td><td>page 147</td><td></td></tr> </table>	White	789-2	£995	Blue	789-3	Black	789-4	Green	789-6	Greige	789-8	Grey	789-9	Push function	PTM-2	£175 / for 2 drawers	Handles	page 147		<p><i>Vanity unit 2 drawers</i></p> <table border="0"> <tr><td>White</td><td>798-2</td><td rowspan="6">£1195</td></tr> <tr><td>Blue</td><td>798-3</td></tr> <tr><td>Black</td><td>798-4</td></tr> <tr><td>Green</td><td>798-6</td></tr> <tr><td>Greige</td><td>798-8</td></tr> <tr><td>Grey</td><td>798-9</td></tr> </table> <p><i>Optional</i></p> <table border="0"> <tr><td>Push function</td><td>PTM-2</td><td>£175 / for 2 drawers</td></tr> <tr><td>Handles</td><td>page 147</td><td></td></tr> </table>	White	798-2	£1195	Blue	798-3	Black	798-4	Green	798-6	Greige	798-8	Grey	798-9	Push function	PTM-2	£175 / for 2 drawers	Handles	page 147	
White	788-2	£975																																																									
Blue	788-3																																																										
Black	788-4																																																										
Green	788-6																																																										
Greige	788-8																																																										
Grey	788-9																																																										
Push function	PTM-2	£175 / for 2 drawers																																																									
Handles	page 147																																																										
White	789-2	£995																																																									
Blue	789-3																																																										
Black	789-4																																																										
Green	789-6																																																										
Greige	789-8																																																										
Grey	789-9																																																										
Push function	PTM-2	£175 / for 2 drawers																																																									
Handles	page 147																																																										
White	798-2	£1195																																																									
Blue	798-3																																																										
Black	798-4																																																										
Green	798-6																																																										
Greige	798-8																																																										
Grey	798-9																																																										
Push function	PTM-2	£175 / for 2 drawers																																																									
Handles	page 147																																																										
<p>Basins</p> <p><i>Basin for 60 vanity</i> W605 x D455 mm</p> <table border="0"> <tr><td>City*</td><td>180W1</td><td rowspan="4">£340</td></tr> <tr><td>D-form</td><td>120W1</td></tr> <tr><td>Rectangular</td><td>110W1</td></tr> <tr><td>Velca</td><td>128W1</td></tr> </table> <p>*City basin W610 x D466 mm</p>	City*	180W1	£340	D-form	120W1	Rectangular	110W1	Velca	128W1	<p><i>Basin for 80 vanity</i> W805 x D455mm</p> <table border="0"> <tr><td>City*</td><td>181W1</td><td rowspan="4">£445</td></tr> <tr><td>D-form</td><td>121W1</td></tr> <tr><td>Rectangular</td><td>111W1</td></tr> <tr><td>Velca</td><td>129W1</td></tr> </table> <p>*City basin W812 x D466 mm</p>	City*	181W1	£445	D-form	121W1	Rectangular	111W1	Velca	129W1	<p><i>Basin for 100 vanity</i> W1005 x D455 mm</p> <table border="0"> <tr><td>City*</td><td>182W1</td><td rowspan="4">£500</td></tr> <tr><td>D-form</td><td>122W1</td></tr> <tr><td>Rectangular</td><td>113W1</td></tr> <tr><td>Velca</td><td>130W1</td></tr> </table> <p>*City basin W1013 x D466 mm</p>	City*	182W1	£500	D-form	122W1	Rectangular	113W1	Velca	130W1																														
City*	180W1	£340																																																									
D-form	120W1																																																										
Rectangular	110W1																																																										
Velca	128W1																																																										
City*	181W1	£445																																																									
D-form	121W1																																																										
Rectangular	111W1																																																										
Velca	129W1																																																										
City*	182W1	£500																																																									
D-form	122W1																																																										
Rectangular	113W1																																																										
Velca	130W1																																																										
<p>120 City</p>  <p>Size vanity W1188 x H625 x D448 mm Basin size see each model below</p>	<p>160 City</p>  <p>Size vanity W1588 x H625 x D448 mm Basin size see each model below</p>	<p>Ceramic Basins in several shapes</p> <table border="0"> <tr> <td></td> <td></td> </tr> <tr> <td>D-shape</td> <td>Rectangulär</td> </tr> <tr> <td></td> <td></td> </tr> <tr> <td>City</td> <td>Velca</td> </tr> </table> <p>Images of basins in all sizes are available on page 142. Measurements are for guidance only, exact measurement should be measured on the delivered basin.</p>			D-shape	Rectangulär			City	Velca																																																	
																																																											
D-shape	Rectangulär																																																										
																																																											
City	Velca																																																										
<p><i>Vanity unit 4 drawers</i></p> <table border="0"> <tr><td>White</td><td>766-2</td><td rowspan="6">£1950</td></tr> <tr><td>Blue</td><td>766-3</td></tr> <tr><td>Black</td><td>766-4</td></tr> <tr><td>Green</td><td>766-6</td></tr> <tr><td>Greige</td><td>766-8</td></tr> <tr><td>Grey</td><td>766-9</td></tr> </table> <p><i>Optional</i></p> <table border="0"> <tr><td>Push function</td><td>PTM-2</td><td>£175 / for 2 drawers</td></tr> <tr><td>Handles</td><td>page 147</td><td></td></tr> </table>	White	766-2	£1950	Blue	766-3	Black	766-4	Green	766-6	Greige	766-8	Grey	766-9	Push function	PTM-2	£175 / for 2 drawers	Handles	page 147		<p><i>Vanity unit 2 drawers</i></p> <table border="0"> <tr><td>White</td><td>777-2</td><td rowspan="6">£1990</td></tr> <tr><td>Blue</td><td>777-3</td></tr> <tr><td>Black</td><td>777-4</td></tr> <tr><td>Green</td><td>777-6</td></tr> <tr><td>Greige</td><td>777-8</td></tr> <tr><td>Grey</td><td>777-9</td></tr> </table> <p><i>Optional</i></p> <table border="0"> <tr><td>Push function</td><td>PTM-2</td><td>£175 / for 2 drawers</td></tr> <tr><td>Handles</td><td>page 147</td><td></td></tr> </table>	White	777-2	£1990	Blue	777-3	Black	777-4	Green	777-6	Greige	777-8	Grey	777-9	Push function	PTM-2	£175 / for 2 drawers	Handles	page 147																					
White	766-2	£1950																																																									
Blue	766-3																																																										
Black	766-4																																																										
Green	766-6																																																										
Greige	766-8																																																										
Grey	766-9																																																										
Push function	PTM-2	£175 / for 2 drawers																																																									
Handles	page 147																																																										
White	777-2	£1990																																																									
Blue	777-3																																																										
Black	777-4																																																										
Green	777-6																																																										
Greige	777-8																																																										
Grey	777-9																																																										
Push function	PTM-2	£175 / for 2 drawers																																																									
Handles	page 147																																																										
<p>Basins</p> <p><i>Basin for 120 vanity 2 bowls</i> W1210 x D455 mm</p> <table border="0"> <tr><td>City*</td><td>183W1</td><td rowspan="4">£755</td></tr> <tr><td>D-form</td><td>123W1</td></tr> <tr><td>Rectangular</td><td>115W1</td></tr> <tr><td>Velca</td><td>131W1</td></tr> </table> <p>*City basin W1217 x D470 mm</p>	City*	183W1	£755	D-form	123W1	Rectangular	115W1	Velca	131W1	<p><i>Basin for 160 vanity 2 bowls</i> W1620 x D470 mm</p> <table border="0"> <tr><td>City</td><td>184W1</td><td>£1445</td></tr> </table> <p>This basin only fits furniture range City. Basin can also be wall hung.</p>	City	184W1	£1445																																														
City*	183W1	£755																																																									
D-form	123W1																																																										
Rectangular	115W1																																																										
Velca	131W1																																																										
City	184W1	£1445																																																									

Door Vanity 40 cm with full cover ceramic basin or worktop with basin

Price separately for vanity, basin and tap.

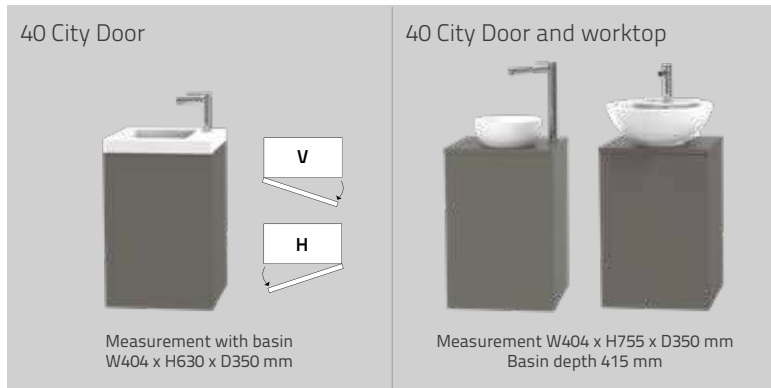

40 City Door		40 City Door and worktop																												
<p>Measurement with basin W404 x H630 x D350 mm</p>		<p>Measurement W404 x H755 x D350 mm Basin depth 415 mm</p>																												
<p><i>Left hand door</i></p> <table border="0"> <tr><td>White</td><td>784V-2</td><td rowspan="9">£545</td></tr> <tr><td>Blue</td><td>784V-3</td></tr> <tr><td>Black</td><td>784V-4</td></tr> <tr><td>Green</td><td>784V-6</td></tr> <tr><td>Greige</td><td>784V-8</td></tr> <tr><td>Grey</td><td>784V-9</td></tr> </table>		White	784V-2	£545	Blue	784V-3	Black	784V-4	Green	784V-6	Greige	784V-8	Grey	784V-9	<p><i>Left hand door</i></p> <table border="0"> <tr><td>White</td><td>784V-2T</td><td rowspan="9">£545</td></tr> <tr><td>Blue</td><td>784V-3T</td></tr> <tr><td>Black</td><td>784V-4T</td></tr> <tr><td>Green</td><td>784V-6T</td></tr> <tr><td>Greige</td><td>784V-8T</td></tr> <tr><td>Grey</td><td>784V-9T</td></tr> </table>		White	784V-2T	£545	Blue	784V-3T	Black	784V-4T	Green	784V-6T	Greige	784V-8T	Grey	784V-9T	
White	784V-2	£545																												
Blue	784V-3																													
Black	784V-4																													
Green	784V-6																													
Greige	784V-8																													
Grey	784V-9																													
White	784V-2T		£545																											
Blue	784V-3T																													
Black	784V-4T																													
Green	784V-6T																													
Greige	784V-8T																													
Grey	784V-9T																													
<p><i>Right hand door</i></p> <table border="0"> <tr><td>White</td><td>784H-2</td><td rowspan="9">£545</td></tr> <tr><td>Blue</td><td>784H-3</td></tr> <tr><td>Black</td><td>784H-4</td></tr> <tr><td>Green</td><td>784H-6</td></tr> <tr><td>Greige</td><td>784H-8</td></tr> <tr><td>Grey</td><td>784H-9</td></tr> </table>		White		784H-2	£545	Blue	784H-3	Black	784H-4	Green	784H-6	Greige	784H-8	Grey	784H-9	<p><i>Right hand door</i></p> <table border="0"> <tr><td>White</td><td>784H-2T</td><td rowspan="9">£545</td></tr> <tr><td>Blue</td><td>784H-3T</td></tr> <tr><td>Black</td><td>784H-4T</td></tr> <tr><td>Green</td><td>784H-6T</td></tr> <tr><td>Greige</td><td>784H-8T</td></tr> <tr><td>Grey</td><td>784H-9T</td></tr> </table>		White	784H-2T	£545	Blue	784H-3T	Black	784H-4T	Green	784H-6T	Greige	784H-8T	Grey	784H-9T
White	784H-2	£545																												
Blue	784H-3																													
Black	784H-4																													
Green	784H-6																													
Greige	784H-8																													
Grey	784H-9																													
White	784H-2T		£545																											
Blue	784H-3T																													
Black	784H-4T																													
Green	784H-6T																													
Greige	784H-8T																													
Grey	784H-9T																													
<p><i>Basin</i></p> <table border="0"> <tr><td>White</td><td>165W1</td><td>£255</td></tr> </table>		White		165W1	£255	<p><i>Basin</i></p> <table border="0"> <tr><td>White</td><td>174W1</td><td>£210</td></tr> <tr><td>White Ø33</td><td>135W1</td><td>£300</td></tr> </table>		White	174W1	£210	White Ø33	135W1	£300																	
White	165W1	£255																												
White	174W1	£210																												
White Ø33	135W1	£300																												
<p><i>Optional Handles</i></p> <p>page 147</p>		<p>Only suitable basins for 40 vanity with worktop is 174W1 and 135W1</p> <p><i>Optional Handles</i></p> <p>page 147</p>																												

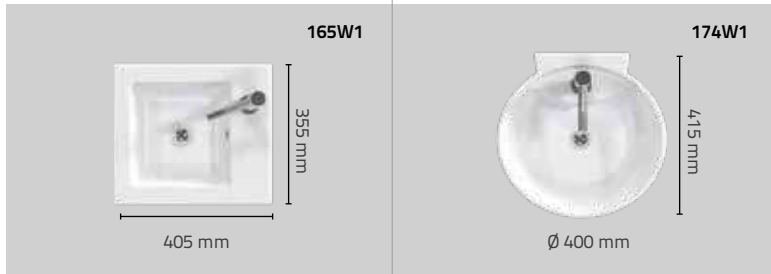

More detailed measurements on www.millerbathrooms.co.uk

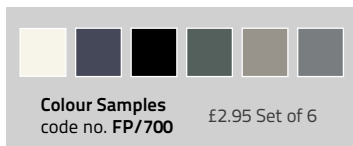

Only suitable basins for 40 vanity with worktop is 174W1 and 135W1

Worktop for vanity 40 City

Stone Worktop

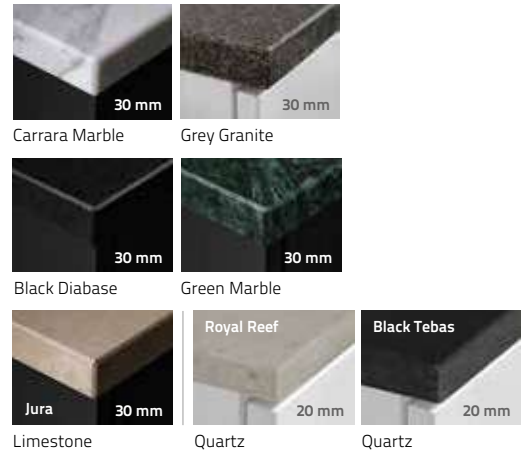

For basin 174W1	For basin 135W - choose -H/-V
30 mm worktop for 40 vanity	30 mm worktop for 40 vanity
Marble 400M £499	Marble 400M-X £499
Granite 400G £499	Granite 400G-X £499
Diabase 400D £540	Diabase 400D-X £540
Green Marble 400GM £499	Green Marble 400GM-X £499
Jura 400J £499	Jura 400J-X £499
20 mm worktop for 40 vanity	20 mm worktop for 40 vanity
Royal Reef 400R £295	Royal Reef 400R-X £295
Black Tebas 400N £295	Black Tebas 400N-X £295
Measurement W408 x D358 mm	Measurement W408 x D358 mm



Worktop City 18 mm



18 mm worktop for 40 vanity	
White	779-2
Blue	779-3
Black	779-4
Green	779-6
Greige	779-8
Grey	779-9

£125

Measurement W408 x D358 mm
Worktop delivered without waste hole.
Punching to be done by installer.



Vanity with stone work top and integrated ceramic basin



Price separately for vanity, worktop with integrated ceramic basin and tap.

60 City	80 City	100 City	120 City
			
Vanity without worktop W594 x H625 x D448 mm	Vanity without worktop W794 x H625 x D448 mm	Vanity without worktop W994 x H625 x D448 mm	Vanity without worktop W1188 x H625 x D498 mm
Vanity 2 drawers White 788-2T Blue 788-3T Black 788-4T Green 788-6T Greige 788-8T Grey 788-9T	Vanity 2 drawers White 789-2T Blue 789-3T Black 789-4T Green 789-6T Greige 789-8T Grey 789-9T	Vanity 2 drawers White 798-2T Blue 798-3T Black 798-4T Green 798-6T Greige 798-8T Grey 798-9T	Deep Vanity 4 drawers White 766-2TD Blue 766-3TD Black 766-4TD Green 766-6TD Greige 766-8TD Grey 766-9TD
£975	£995	£1195	£1950
Optional Push function Handles PTM-2 £175/for 2 drawers page 147	Optional Push function Handles PTM-2 £175/for 2 drawers page 147	Optional Push function Handles PTM-2 £175/for 2 drawers page 147	Optional Push function Handles PTM-2 £175/for 2 drawers page 147

Choose stone worktop with integrated ceramic basin

for 60 vanity	for 80 vanity	for 100 vanity	for 120 vanity
Marble 134W/600M £1699 Granite 134W/600G £1599 Diabase 134W/600D £1699 Green Marble 134W/600GM £1699 Jura 134W/600J £1699 Price incl.integrated ceramic basin Size worktop W595 x D455 x H30 mm	Marble 134W/800M £1799 Granite 134W/800G £1699 Diabase 134W/800D £1799 Green Marble 134W/800GM £1799 Jura 134W/800J £1799 Price incl.integrated ceramic basin Size worktop W800 x D455 x H30 mm	Marble 134W/1000M £1899 Granite 134W/1000G £1799 Diabase 134W/1000D £1899 Green Marble 134W/1000GM £1899 Jura 134W/1000J £1899 Price incl.integrated ceramic basin Size worktop W1000 x D455 x H30 mm	Granite 134W/1200M POR* Granite 134W/1200G POR* Diabase 134W/1200D POR* Green Marble 134W/1200GM POR* Jura 134W/1200J POR* Price incl.integrated ceramic basins Size worktop W1200 x D455 x H30 mm

60	80	100	120
			
Total size work top W600 x D455 x H30 mm Ceramic W490 x D320 mm Max depth bowl 160 mm	Total size work top W800 x D455 x H30 mm Ceramic W490 x D320 mm Max depth bowl 160 mm	Total size work top W1000 x D455 x H30 mm Ceramic W490 x D320 mm Max depth bowl 160 mm	Total size work top W1200 x D505 x H30 mm Ceramic W490 x D320 mm Max depth bowls 160 mm

160 City	160
	
Vanity without worktop W1588 x H625 x D498 mm	Total size work top W1595 x D505 x H30 mm Ceramic W490 x D320 mm x 2 skålar Max depth bowls 160 mm
Deep Vanity 4 drawers White 777-2TD Blue 777-3TD Black 777-4TD Green 777-6TD Greige 777-8TD Grey 777-9TD	for 160 vanity Marble 134W/1600M Granit 134W/1600G Diabas 134W/1600D POR* Green Marble 134W/1600GM Jura 134W/1600J Price incl.integrated ceramic basins Size worktop W1595 x D455 x H30 mm *Price on request
£1990	
Optional Push function Handles PTM-2 £175/for 2 drawers page 147	

Stone Worktop 30 mm



Carrara Marble



Green Marble



Black Diabase



Granite



Jura Limestone

Limestone 30 mm

Vanity with wood work top

Price separately for vanity, worktop with integrated ceramic basin and tap.

60 City	80 City	100 City	120 City
			
Vanity without worktop W594 x H625 x D448 mm Basin size see each model below	Vanity without worktop W794 x H625 x D448 mm Basin size see each model below	Vanity without worktop W994 x H625 x D448 mm Basin size see each model below	Vanity without worktop W1188 x H625 x D448 mm Basin size see each model below
Vanity 2 drawers White 788-2T Blue 788-3T Black 788-4T Green 788-6T Greige 788-8T Grey 788-9T £975	Vanity 2 drawers White 789-2T Blue 789-3T Black 789-4T Green 789-6T Greige 789-8T Grey 789-9T £995	Vanity 2 drawers White 798-2T Blue 798-3T Black 798-4T Green 798-6T Greige 798-8T Grey 798-9T £1195	Vanity 4 drawers White 766-2T Blue 766-3T Black 766-4T Green 766-6T Greige 766-8T Grey 766-9T £1950
<i>Optional</i> Push function PTM-2 £175/for 2 drawers Handles page 147	<i>Optional</i> Push function PTM-2 £175/for 2 drawers Handles page 147	<i>Optional</i> Push function PTM-2 £175/for 2 drawers Handles page 147	<i>Optional</i> Push function PTM-2 £175/for 2 drawers Handles page 147
Worktop 18 mm <i>for 60 vanity</i> White 600-2 £155 Blue 600-3 £155 Black 600-4 £155 Green 600-6 £155 Greige 600-8 £155 Grey 600-9 £155 Size worktop W600 x D455 mm	<i>for 80 vanity</i> White 800-2 £195 Blue 800-3 £195 Black 800-4 £195 Green 800-6 £195 Greige 800-8 £195 Grey 800-9 £195 Size worktop W800 x D455 mm	<i>for 100 vanity</i> White 1000-2 £235 Blue 1000-3 £235 Black 1000-4 £235 Green 1000-6 £235 Greige 1000-8 £235 Grey 1000-9 £235 Size worktop W1000 x D455 mm	<i>for 120 vanity</i> White 1200-2 £295 Blue 1200-3 £295 Black 1200-4 £295 Green 1200-6 £295 Greige 1200-8 £295 Grey 1200-9 £295 Size worktop W1200 x D455 mm



Vanity 4 drawers White 777-2T Blue 777-3T Black 777-4T Green 777-6T Greige 777-8T Grey 777-9T £1990	<i>Optional</i> Push function PTM-2 £175/for 2 drawers Handles page 147
---	--

<i>for 160 vanity</i> White 1600-2 Blue 1600-3 Black 1600-4 Green 1600-6 Greige 1600-8 Grey 1600-9 £395	Size worktop W1600 x D455 mm
--	------------------------------

Worktop
Height 18 mm
Worktop delivered without waste hole.
Punching to be done by installer.

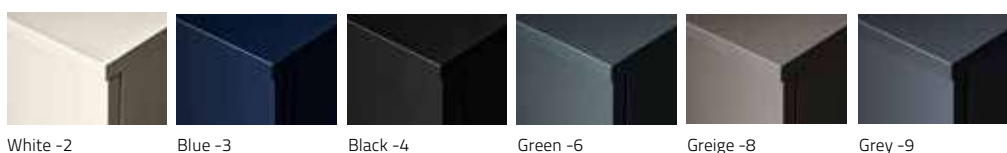

Basin for worktop, column tap mounted on the side of the basin	136W	133W	132W
136W £330 133W £315 132W £315			
<i>Only column taps are suitable for these washbasins: 1941C, 1941MP, 1941B.</i>			
	Ø390 x H140 mm Max. depth bowl 100 mm	Ø390 x H150 mm Max. depth bowl 130 mm	W390 x D390 x H130 mm Max. depth bowl 95 mm

Basin for worktop, tap mounted on the basin	116W1	117W1	171W1	173W1
116W1 £470 117W1 £500 171W1 £299 173W1 £299				
<i>Measurements of each basin is available on millerbathrooms.co.uk</i>	W500 x D495 x H180 mm	W680 x D500 x H180 mm	Ø460 x H180 mm	W550 x H130 x D450 mm

Vanity with work top and basin, tap mounted on the basin

Price separately for vanity, basin and tap.



60 City	80 City	100 City	120 City
Vanity without worktop W594 x H625 x D448 mm Basin size see each model below	Vanity without worktop W794 x H625 x D448 mm Basin size see each model below	Vanity without worktop W994 x H625 x D448 mm Basin size see each model below	Vanity without worktop W1188 x H625 x D448 mm Basin size see each model below
Vanity 2 drawers	Vanity 2 drawers	Vanity 2 drawers	Deep Vanity 4 drawers
White 788-2T	White 789-2T	White 798-2T	White 766-2T
Blue 788-3T	Blue 789-3T	Blue 798-3T	Blue 766-3T
Black 788-4T	Black 789-4T	Black 798-4T	Black 766-4T
Green 788-6T	Green 789-6T	Green 798-6T	Green 766-6T
Greige 788-8T	Greige 789-8T	Greige 798-8T	Greige 766-8T
Grey 788-9T	Grey 789-9T	Grey 798-9T	Grey 766-9T
Optional Push function Handles	Optional Push function Handles	Optional Push function Handles	Optional Push function Handles
PTM-2 £175/for 2 drawers page 147	PTM-2 £175/for 2 drawers page 147	PTM-2 £175/for 2 drawers page 147	PTM-2 £175/for 2 drawers page 147

Worktop

60 City	80 City	100 City	120 City
Worktop for 60 vanity	Worktop for 80 vanity	Worktop for 100 vanity	Worktop for 120 vanity
Granite 600G £620	Granite 800G £720	Granite 1000G £825	Granite 1200G £1029
Marble 600M £620	Marble 800M £720	Marble 1000M £825	Marble 1200M £1029
Diabase 600D £720	Diabase 800D £825	Diabase 1000D £979	Diabase 1200D £1239
Green Marble 600GM £620	Green Marble 800GM £720	Green Marble 1000GM £825	Green Marble 1200GM £1029
Jura 600J £620	Jura 800J £720	Jura 1000J £825	Jura 1200J £1029
Royal Reef 600R £465	Royal Reef 800R £495	Royal Reef 1000R £565	Royal Reef 1200R £895
Black Tebas 600N £465	Black Tebas 800N £495	Black Tebas 1000N £565	Svart Tebas 1200N £895
Size worktop W595 x D455 mm For height see each work top	Size worktop W795 x D455 mm For height see each work top	Size worktop W995 x D455 mm For height see each work top	Size worktop W1595 x D455 mm For height see each work top



Deep Vanity 4 drawers	Worktop for 160 vanity
White 777-2T	Marble 1600M
Blue 777-3T	Granite 1600G
Black 777-4T	Diabas 1600D
Green 777-6T	Grön Marmor 1600GM
Greige 777-8T	Jura 1600J
Grey 777-9T	Royal Reef 1600R
Optional Push function Handles	Svart Tebas 1600N
PTM-2 £175/for 2 drawers page 147	Price on request
	Size worktop W1595 x D455 mm For height see each work top

Stone worktop 30 mm

Up to 6 weeks delivery



Grey Granite

Carrara Marble

Black Diabase

Green Marble

Jura

Royal Reef

Svart Tebas

Limestone

Up to 6 weeks delivery

Worktop quartz stone 20 mm

Up to 8 weeks delivery

Ceramic basins in four shapes

116W1	£470
117W1	£500
171W1	£299
173W1	£299

Measurements of each basin is available on millerbathrooms.co.uk

116W1



W500 x D495 x H180 mm

117W1



W680 x D500 x H180 mm

171W1



Ø460 x H180 mm

173W1



W550 x H130 x D450 mm

Vanity with work top and basin, column tap mounted on the worktop

Price separately for vanity, basin and tap.

60 City	80 City	100 City	120 City
			
Vanity without worktop W594 x H625 x D448 mm Basin size see each model below	Vanity without worktop W794 x H625 x D448 mm Basin size see each model below	Vanity without worktop W994 x H625 x D448 mm Basin size see each model below	Vanity without worktop W1188 x H625 x D448 mm Basin size see each model below
Vanity 2 drawers White 788-2T Blue 788-3T Black 788-4T Green 788-6T Greige 788-8T Grey 788-9T	Vanity 2 drawers White 789-2T Blue 789-3T Black 789-4T Green 789-6T Greige 789-8T Grey 789-9T	Vanity 2 drawers White 798-2T Blue 798-3T Black 798-4T Green 798-6T Greige 798-8T Grey 798-9T	Deep Vanity 4 drawers White 766-2T Blue 766-3T Black 766-4T Green 766-6T Greige 766-8T Grey 766-9T
£975	£995	£1195	£1950
Optional Push function PTM-2 £175/for 2 drawers Handles page 147	Optional Push function PTM-2 £175/for 2 drawers Handles page 147	Optional Push function PTM-2 £175/for 2 drawers Handles page 147	Optional Push function PTM-2 £175/for 2 drawers Handles page 147
Worktop Worktop for 60 vanity Granite 600G-X £620 Marble 600M-X £620 Diabase 600D-X £720 Green Marble 600GM-X £620 Jura 600J-X £620 Royal Reef 600R-X £465 Black Tebas 600N-X £465 Size worktop W595 x D455 mm For height see each work top	Worktop for 80 vanity Granite 800G-X £720 Marble 800M-X £720 Diabase 800D-X £825 Green Marble 800GM-X £720 Jura 800J-X £720 Royal Reef 800R-X £495 Black Tebas 800N-X £495 Size worktop W795 x D455 mm For height see each work top	Worktop for 100 vanity Granite 1000G-X £825 Marble 1000M-X £825 Diabase 1000D-X £979 Green Marble 1000GM-X £825 Jura 1000J-X £825 Royal Reef 1000R-X £565 Black Tebas 1000N-X £565 Size worktop W995 x D455 mm For height see each work top	Worktop for 120 vanity Granit 1200G-X £1029 Marble 1200M-X £1029 Diabase 1200D-X £1029 Green Marble 1200GM-X £1239 Jura 1200J-X £1029 Royal Reef 1200R-X £895 Svart Tebas 1200N-X £895 Size worktop W1595 x D455 mm For height see each work top

NOTE -X, choose hole pattern, ex. 600M-V is a 60 cm marble worktop with tap hole to the left of the basin
ex. 600D-H is a 60 cm diabase worktop with tap hole to the right of the basin

160 City

Vanity without worktop W1588 x H625 x D448 mm Basin size see each model below
Deep Vanity 4 drawers White 777-2T Blue 777-3T Black 777-4T Green 777-6T Greige 777-8T Grey 777-9T
£1990
Optional Push function PTM-2 £175/for 2 drawers Handles page 147
Worktop for 160 vanity Marble 1600M-X Granite 1600G-X Diabas 1600D-X Grön Marmor 1600GM-X Jura 1600J-X Royal Reef 1600R-X Svart Tebas 1600N-X Price on request Size worktop W1595 x D455 mm For height see each work top

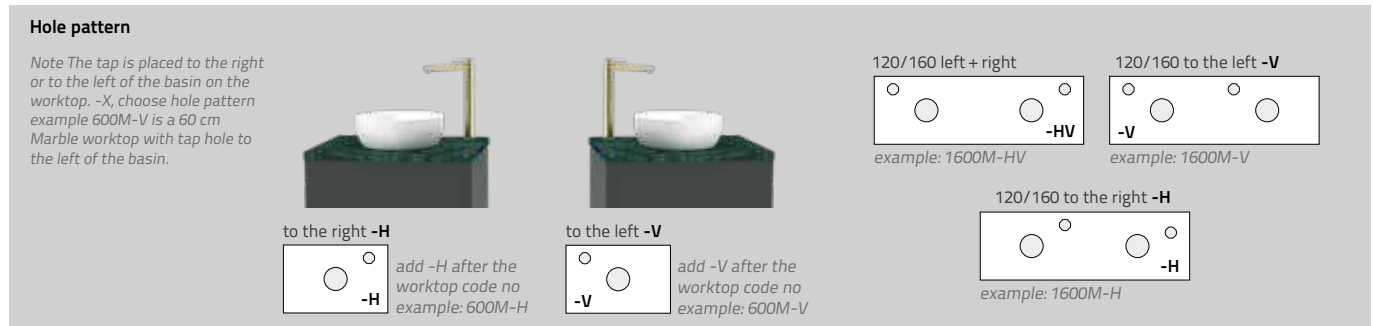

Basin for worktop, column tap mounted on the side of the basin	136W	133W	132W
136W £330 133W £315 132W £315			
Only column taps are suitable for these washbasins: 1941C, 1941MP, 1941B.	Ø390 x H140 mm Max. depth bowl 100 mm	Ø390 x H150 mm Max. depth bowl 130 mm	W390 x D390 x H130 mm Max. depth bowl 95 mm

STORAGE CITY

Fitted with mounting rails and brackets for easy adjustment and quick installation. Soft closing doors and drawers. V stands for left hand door and H stands for right hand door (see sketch). All furniture is delivered fully assembled.

Read more about the Miller Way on www.millerbathrooms.co.uk

<p>Tall Cabinet</p> <p>1 fixed and 4 adjustable wood shelves</p>  <p>W404 x H1690 x D380 mm</p> <p><i>Left hand door</i></p> <table border="0"> <tr><td>White</td><td>793V-2</td><td rowspan="6">£1195</td></tr> <tr><td>Blue</td><td>793V-3</td></tr> <tr><td>Black</td><td>793V-4</td></tr> <tr><td>Green</td><td>793V-6</td></tr> <tr><td>Greige</td><td>793V-8</td></tr> <tr><td>Grey</td><td>793V-9</td></tr> </table> <p><i>Right hand door</i></p> <table border="0"> <tr><td>White</td><td>793H-2</td><td rowspan="6">£1195</td></tr> <tr><td>Blue</td><td>793H-3</td></tr> <tr><td>Black</td><td>793H-4</td></tr> <tr><td>Green</td><td>793H-6</td></tr> <tr><td>Greige</td><td>793H-8</td></tr> <tr><td>Grey</td><td>793H-9</td></tr> </table> <p><i>Optional Handle</i> page 147</p>	White	793V-2	£1195	Blue	793V-3	Black	793V-4	Green	793V-6	Greige	793V-8	Grey	793V-9	White	793H-2	£1195	Blue	793H-3	Black	793H-4	Green	793H-6	Greige	793H-8	Grey	793H-9	<p>Tall Cabinet with door storage</p> <p>1 fixed and 4 adjustable wood shelves Door storage 2 boxes in solid oak.</p>  <p>W404 x H1690 x D380 mm</p> <p><i>Left hand door</i></p> <table border="0"> <tr><td>White</td><td>794V-2</td><td rowspan="6">£1395</td></tr> <tr><td>Blue</td><td>794V-3</td></tr> <tr><td>Black</td><td>794V-4</td></tr> <tr><td>Green</td><td>794V-6</td></tr> <tr><td>Greige</td><td>794V-8</td></tr> <tr><td>Grey</td><td>794V-9</td></tr> </table> <p><i>Right hand door</i></p> <table border="0"> <tr><td>White</td><td>794H-2</td><td rowspan="6">£1395</td></tr> <tr><td>Blue</td><td>794H-3</td></tr> <tr><td>Black</td><td>794H-4</td></tr> <tr><td>Green</td><td>794H-6</td></tr> <tr><td>Greige</td><td>794H-8</td></tr> <tr><td>Grey</td><td>794H-9</td></tr> </table> <p><i>Optional Handle</i> page 147</p>	White	794V-2	£1395	Blue	794V-3	Black	794V-4	Green	794V-6	Greige	794V-8	Grey	794V-9	White	794H-2	£1395	Blue	794H-3	Black	794H-4	Green	794H-6	Greige	794H-8	Grey	794H-9	<p>Tall Cabinet with door storage and 2 drawers</p> <p>1 fixed and 4 adjustable wood shelves Door storage 2 boxes in solid oak and 2 oak drawers.</p>  <p>W404 x H1690 x D380 mm</p> <p><i>Left hand door</i></p> <table border="0"> <tr><td>White</td><td>795V-2</td><td rowspan="6">£1950</td></tr> <tr><td>Blue</td><td>795V-3</td></tr> <tr><td>Black</td><td>795V-4</td></tr> <tr><td>Green</td><td>795V-6</td></tr> <tr><td>Greige</td><td>795V-8</td></tr> <tr><td>Grey</td><td>795V-9</td></tr> </table> <p><i>Right hand door</i></p> <table border="0"> <tr><td>White</td><td>795H-2</td><td rowspan="6">£1950</td></tr> <tr><td>Blue</td><td>795H-3</td></tr> <tr><td>Black</td><td>795H-4</td></tr> <tr><td>Green</td><td>795H-6</td></tr> <tr><td>Greige</td><td>795H-8</td></tr> <tr><td>Grey</td><td>795H-9</td></tr> </table> <p><i>Optional Handle</i> page 147</p>	White	795V-2	£1950	Blue	795V-3	Black	795V-4	Green	795V-6	Greige	795V-8	Grey	795V-9	White	795H-2	£1950	Blue	795H-3	Black	795H-4	Green	795H-6	Greige	795H-8	Grey	795H-9
White	793V-2	£1195																																																																														
Blue	793V-3																																																																															
Black	793V-4																																																																															
Green	793V-6																																																																															
Greige	793V-8																																																																															
Grey	793V-9																																																																															
White	793H-2	£1195																																																																														
Blue	793H-3																																																																															
Black	793H-4																																																																															
Green	793H-6																																																																															
Greige	793H-8																																																																															
Grey	793H-9																																																																															
White	794V-2	£1395																																																																														
Blue	794V-3																																																																															
Black	794V-4																																																																															
Green	794V-6																																																																															
Greige	794V-8																																																																															
Grey	794V-9																																																																															
White	794H-2	£1395																																																																														
Blue	794H-3																																																																															
Black	794H-4																																																																															
Green	794H-6																																																																															
Greige	794H-8																																																																															
Grey	794H-9																																																																															
White	795V-2	£1950																																																																														
Blue	795V-3																																																																															
Black	795V-4																																																																															
Green	795V-6																																																																															
Greige	795V-8																																																																															
Grey	795V-9																																																																															
White	795H-2	£1950																																																																														
Blue	795H-3																																																																															
Black	795H-4																																																																															
Green	795H-6																																																																															
Greige	795H-8																																																																															
Grey	795H-9																																																																															
<p>Tall Cabinet with 2 drawers</p> <p>1 fixed and 3 adjustable wood shelves, 2 oak drawers.</p>  <p>W404 x H1690 x D380 mm</p> <p><i>Left hand door</i></p> <table border="0"> <tr><td>White</td><td>792V-2</td><td rowspan="6">£1545</td></tr> <tr><td>Blue</td><td>792V-3</td></tr> <tr><td>Black</td><td>792V-4</td></tr> <tr><td>Green</td><td>792V-6</td></tr> <tr><td>Greige</td><td>792V-8</td></tr> <tr><td>Grey</td><td>792V-9</td></tr> </table> <p><i>Right hand door</i></p> <table border="0"> <tr><td>White</td><td>792H-2</td><td rowspan="6">£1545</td></tr> <tr><td>Blue</td><td>792H-3</td></tr> <tr><td>Black</td><td>792H-4</td></tr> <tr><td>Green</td><td>792H-6</td></tr> <tr><td>Greige</td><td>792H-8</td></tr> <tr><td>Grey</td><td>792H-9</td></tr> </table> <p><i>Optional Handle</i> page 147</p>	White	792V-2	£1545	Blue	792V-3	Black	792V-4	Green	792V-6	Greige	792V-8	Grey	792V-9	White	792H-2	£1545	Blue	792H-3	Black	792H-4	Green	792H-6	Greige	792H-8	Grey	792H-9	<p>Storage Cabinet</p> <p>3 adjustable glass shelves</p>  <p>W304 x H1111 x D255 mm</p> <p><i>Left hand door</i></p> <table border="0"> <tr><td>White</td><td>796V-2</td><td rowspan="6">£695</td></tr> <tr><td>Blue</td><td>796V-3</td></tr> <tr><td>Black</td><td>796V-4</td></tr> <tr><td>Green</td><td>796V-6</td></tr> <tr><td>Greige</td><td>796V-8</td></tr> <tr><td>Grey</td><td>796V-9</td></tr> </table> <p><i>Right hand door</i></p> <table border="0"> <tr><td>White</td><td>796H-2</td><td rowspan="6">£695</td></tr> <tr><td>Blue</td><td>796H-3</td></tr> <tr><td>Black</td><td>796H-4</td></tr> <tr><td>Green</td><td>796H-6</td></tr> <tr><td>Greige</td><td>796H-8</td></tr> <tr><td>Grey</td><td>796H-9</td></tr> </table> <p><i>Optional Handle</i> page 147</p>	White	796V-2	£695	Blue	796V-3	Black	796V-4	Green	796V-6	Greige	796V-8	Grey	796V-9	White	796H-2	£695	Blue	796H-3	Black	796H-4	Green	796H-6	Greige	796H-8	Grey	796H-9	<p>Right or left hand door?</p>  <p>V = Left hand door</p> <p>H = Right hand door</p> <p>Choose between a right or left hand door on your storage cabinet. See sketch above. V is for left hand door and H is right hand door in the code no.</p> <p>We do not offer "Push Function" for our storage cabinets at the moment.</p>																										
White	792V-2	£1545																																																																														
Blue	792V-3																																																																															
Black	792V-4																																																																															
Green	792V-6																																																																															
Greige	792V-8																																																																															
Grey	792V-9																																																																															
White	792H-2	£1545																																																																														
Blue	792H-3																																																																															
Black	792H-4																																																																															
Green	792H-6																																																																															
Greige	792H-8																																																																															
Grey	792H-9																																																																															
White	796V-2	£695																																																																														
Blue	796V-3																																																																															
Black	796V-4																																																																															
Green	796V-6																																																																															
Greige	796V-8																																																																															
Grey	796V-9																																																																															
White	796H-2	£695																																																																														
Blue	796H-3																																																																															
Black	796H-4																																																																															
Green	796H-6																																																																															
Greige	796H-8																																																																															
Grey	796H-9																																																																															

Colours

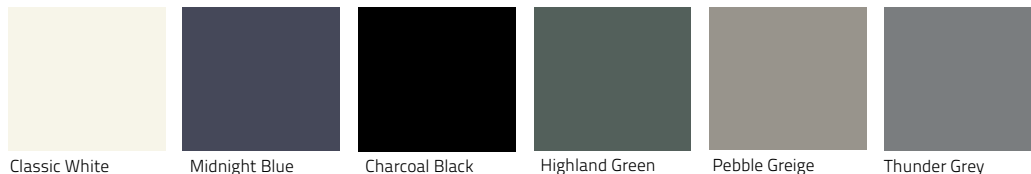

Classic White

Midnight Blue

Charcoal Black

Highland Green

Pebble Greige

Thunder Grey



Tall Cabinet 40 cm
795H-3
Midnight Blue



Tall Cabinet 40 cm
793H-9
Pebble Greige



Storage Cabinet 30 cm
796H-6
Highland Green

OPTIONAL STORAGE

Handle



Handles and knobs. Choose between various finishes, shapes and sizes to create your personal touch. See page 147.

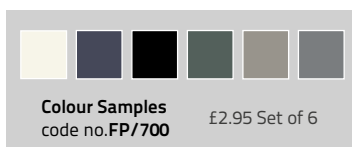

MIRROR CABINET LINEAR LED CITY

Integrated dimmable light with touch sensor. Technically powerful LED light creates illuminated lines with better colour reproduction. Perfect for makeup. Linear LED cabinets are dimmed via the touch sensor on the mirror cabinet, not via dimmers on the wall. IP44 rated.

Fitted with mounting rails and brackets for adjustable & quick installation. Soft closing double sided mirror doors. Choose left or right hand door for the 40 bathroom cabinet, see illustration below. All furniture is delivered fully assembled.

Read more about the Miller Way on www.millerbathrooms.co.uk

Colours

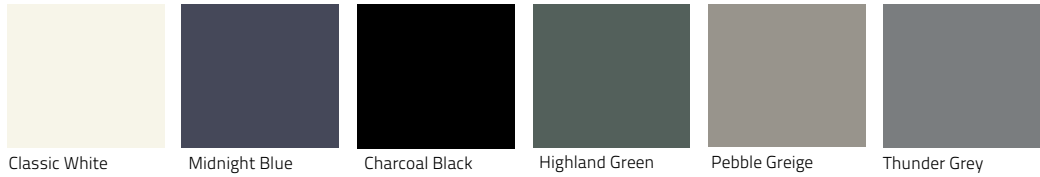

40 / 60 / 80 / 100

The inside of all cabinets is white.

<p>40 City linear led</p> <p>W404 x H700 x D145 mm</p>	<p>2 x glass shelves, IP44</p> <p><i>Left hand door</i></p> <table border="0"> <tr><td>White</td><td>752VL-2</td><td>£675</td></tr> <tr><td>Blue</td><td>752VL-3</td><td>£675</td></tr> <tr><td>Black</td><td>752VL-4</td><td>£675</td></tr> <tr><td>Green</td><td>752VL-6</td><td>£675</td></tr> <tr><td>Greige</td><td>752VL-8</td><td>£675</td></tr> <tr><td>Grey</td><td>752VL-9</td><td>£675</td></tr> </table> <p><i>Right hand door</i></p> <table border="0"> <tr><td>White</td><td>752HL-2</td><td>£675</td></tr> <tr><td>Blue</td><td>752HL-3</td><td>£675</td></tr> <tr><td>Black</td><td>752HL-4</td><td>£675</td></tr> <tr><td>Green</td><td>752HL-6</td><td>£675</td></tr> <tr><td>Greige</td><td>752HL-8</td><td>£675</td></tr> <tr><td>Grey</td><td>752HL-9</td><td>£675</td></tr> </table> <p><i>Optional</i></p> <table border="0"> <tr><td>Down Light</td><td>DL2</td><td>£79</td></tr> <tr><td>2 extra glass shelves</td><td>54-190</td><td>£21</td></tr> </table>	White	752VL-2	£675	Blue	752VL-3	£675	Black	752VL-4	£675	Green	752VL-6	£675	Greige	752VL-8	£675	Grey	752VL-9	£675	White	752HL-2	£675	Blue	752HL-3	£675	Black	752HL-4	£675	Green	752HL-6	£675	Greige	752HL-8	£675	Grey	752HL-9	£675	Down Light	DL2	£79	2 extra glass shelves	54-190	£21
White	752VL-2	£675																																									
Blue	752VL-3	£675																																									
Black	752VL-4	£675																																									
Green	752VL-6	£675																																									
Greige	752VL-8	£675																																									
Grey	752VL-9	£675																																									
White	752HL-2	£675																																									
Blue	752HL-3	£675																																									
Black	752HL-4	£675																																									
Green	752HL-6	£675																																									
Greige	752HL-8	£675																																									
Grey	752HL-9	£675																																									
Down Light	DL2	£79																																									
2 extra glass shelves	54-190	£21																																									
<p>60 City linear led</p> <p>W594 x H700 x D145 mm</p>	<p>4 x glass shelves, centre wood divider, IP44</p> <table border="0"> <tr><td>White</td><td>753L-2</td><td>£845</td></tr> <tr><td>Blue</td><td>753L-3</td><td>£845</td></tr> <tr><td>Black</td><td>753L-4</td><td>£845</td></tr> <tr><td>Green</td><td>753L-6</td><td>£845</td></tr> <tr><td>Greige</td><td>753L-8</td><td>£845</td></tr> <tr><td>Grey</td><td>753L-9</td><td>£845</td></tr> </table> <p><i>Optional</i></p> <table border="0"> <tr><td>Down Light</td><td>DL2</td><td>£79</td></tr> <tr><td>2 extra glass shelves</td><td>53-190</td><td>£19</td></tr> </table>	White	753L-2	£845	Blue	753L-3	£845	Black	753L-4	£845	Green	753L-6	£845	Greige	753L-8	£845	Grey	753L-9	£845	Down Light	DL2	£79	2 extra glass shelves	53-190	£19																		
White	753L-2	£845																																									
Blue	753L-3	£845																																									
Black	753L-4	£845																																									
Green	753L-6	£845																																									
Greige	753L-8	£845																																									
Grey	753L-9	£845																																									
Down Light	DL2	£79																																									
2 extra glass shelves	53-190	£19																																									
<p>80 City linear led</p> <p>W794 x H700 x D145 mm</p>	<p>4 x glass shelves, centre wood divider, IP44</p> <table border="0"> <tr><td>White</td><td>754L-2</td><td>£925</td></tr> <tr><td>Blue</td><td>754L-3</td><td>£925</td></tr> <tr><td>Black</td><td>754L-4</td><td>£925</td></tr> <tr><td>Green</td><td>754L-6</td><td>£925</td></tr> <tr><td>Greige</td><td>754L-8</td><td>£925</td></tr> <tr><td>Grey</td><td>754L-9</td><td>£925</td></tr> </table> <p><i>Optional</i></p> <table border="0"> <tr><td>Down Light</td><td>DL2</td><td>£79</td></tr> <tr><td>2 extra glass shelves</td><td>54-190</td><td>£21</td></tr> </table>	White	754L-2	£925	Blue	754L-3	£925	Black	754L-4	£925	Green	754L-6	£925	Greige	754L-8	£925	Grey	754L-9	£925	Down Light	DL2	£79	2 extra glass shelves	54-190	£21																		
White	754L-2	£925																																									
Blue	754L-3	£925																																									
Black	754L-4	£925																																									
Green	754L-6	£925																																									
Greige	754L-8	£925																																									
Grey	754L-9	£925																																									
Down Light	DL2	£79																																									
2 extra glass shelves	54-190	£21																																									
<p>100 City linear led</p> <p>W994 x H700 x D145 mm</p>	<p>4 x glass shelves, centre wood divider, IP44</p> <table border="0"> <tr><td>White</td><td>755L-2</td><td>£975</td></tr> <tr><td>Blue</td><td>755L-3</td><td>£975</td></tr> <tr><td>Black</td><td>755L-4</td><td>£975</td></tr> <tr><td>Green</td><td>755L-6</td><td>£975</td></tr> <tr><td>Greige</td><td>755L-8</td><td>£975</td></tr> <tr><td>Grey</td><td>755L-9</td><td>£975</td></tr> </table> <p><i>Optional</i></p> <table border="0"> <tr><td>Down Light</td><td>DL2</td><td>£79</td></tr> <tr><td>2 extra glass shelves</td><td>55-190</td><td>£23</td></tr> </table>	White	755L-2	£975	Blue	755L-3	£975	Black	755L-4	£975	Green	755L-6	£975	Greige	755L-8	£975	Grey	755L-9	£975	Down Light	DL2	£79	2 extra glass shelves	55-190	£23																		
White	755L-2	£975																																									
Blue	755L-3	£975																																									
Black	755L-4	£975																																									
Green	755L-6	£975																																									
Greige	755L-8	£975																																									
Grey	755L-9	£975																																									
Down Light	DL2	£79																																									
2 extra glass shelves	55-190	£23																																									

MIRROR CABINET LINEAR LED CITY

Details



Centre divider in wood for stability and a more flexible placement of the shelves.



Control the brightness with a touch sensor. Our new Bathroom Cabinet memorises the latest desired brightness when switched on and off.



The lighting is integrated in the sides of the bathroom cabinets and measures 16 mm x 16 mm. Matching Down Light DL2.



Light shines both forward and inward on cabinets.

OPTIONAL

Down Light Linear Led



Chrome **DL2** £79

Chrome finish. White neutral sheen. IP44. Dimmable with Linear Led Mirror Cabinet. 1 down light fits cabinet 40, 60, 80 and 100.

Can only be combined with Linear Led Mirror Cabinet, Linear Led Mirrors and Linead Led Top Light L102.

Extra Glass Shelves



For right size please see optional under each bathroom cabinet.

Shelf brackets are included.

<p>Colour Samples code no.FP/700</p>					<p>£2.95 Set of 6</p>

KENSINGTON

60, 80, 100 cm

Decorative framed mirror doors and drawers

Floor standing or Wall hung



New times need new elegance - as well as a splash of classical beauty. Our new bathroom collection Kensington unites timeless beauty with a new era of design. The slightly bevelled sides, the beautiful well-designed frame mirrors, the care in every detail and the beautiful finish fills your bathroom with new, beautiful feelings.

Choose from a sleek rustic floor standing vanity with plinth or make use of the space in your bathroom with a beautiful wall-mounted vanity. Enjoy the choice between fashion colours white or dark grey or combine. Kensington surprises with plenty of space for both style and feel.

Kensington 80
Mirror Cabinet 54L-9
Decorative top for Mirror Cabinet 06-454-9
Down Light DL2
Vanity 489-9
Worktop with Basin 134W/800M
Tap 1940C
Storage 495V-9
WC 794W, Seat 348-4
Accessories Stockholm/Classic



Stone worktop with integrated basin. Available in 60, 80 and 100 cm. Choose between Italian Carrara Marble, black Diabase and grey Granite.



The basin is recessed in the stone work top which gives a 10 mm thin stone edge on the inside even though the stone worktops are 30 mm.



Kensington vanity units and storage units are available as floor standing with a plinth for a solid built impression. Alternatively as a wall hung option.



With different handles you can create your personal touch. Above is knob 93810 Ø30 mm.



The wall hung vanities feature a decorative bottom plate.



Wall hung vanity 60 with a Carrara Marble worktop.



A storage cabinet that gives more room and takes less space.



Adjustable wooden shelves in combination with drawers for optimal storage.



Choose between four different full cover ceramic basins. Image shows basin 121W1 D-shape 80 cm. Tap 1940MP cover cap 110W1-190-A and handle 94649 c/c 224 mm in polished brass. Accessories Bond untreated brass.



Our latest addition is Stone Worktops in Green Marble.



The basin is recessed in the Stone Worktop which gives a 10 mm thin stone edge on the inside even though the stone worktops are 30 mm.



Floor standing vanity 80 with linear led 80 Mirror Cabinet. Classic wall hung WC 794W with seat 348-2



The plinth gives a solid built feel. The front is removable to ease cleaning under the vanity.

Decorative framed mirror doors and drawers. Choose between floor standing or wall hung. Available in white and dark grey.

Soft closing drawers and doors. The drawers are sturdy, fully expandable and fitted with anti-slip mats. Vanity bottom drawers are fitted with an adjustable bar to stop larger items from moving.

For your vanity you can choose between a full cover basin, stone worktop with integrated basin or a worktop with basin. See options below.

Complete the look with our range of taps and handles to add your own finished character to the bathroom furniture.

The furniture is delivered fully assembled.

Colour

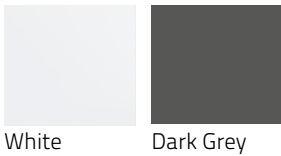

Drawer Vanities in four ways:



1. Drawer Vanity with full cover basin
2. Drawer Vanity with stone worktop and integrated ceramic basin
3. Drawer Vanity with worktop, basin and tap mounted on the worktop
4. Drawer Vanity with worktop and basin with tap mounted on the basin

Full Cover Ceramic Basins in several shapes

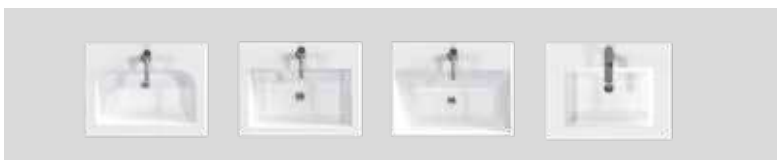

Stone Worktop with integrated ceramic basin



Basin for worktop, tap mounted on the work top



Basins for worktop, tap mounted on the basin



Stone Work top

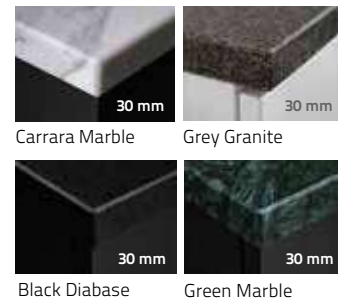

Limestone



Work top Quartz Stone

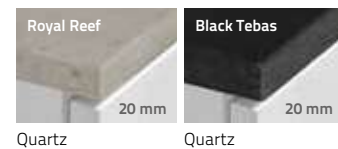

Our bathroom furniture has a 10 year guarantee

DETAILS KENSINGTON

Symbol shows that this feature is optional. **T**



Fully extendable, soft closing drawers. Lower vanity drawers are equipped with an adjustable retaining bar that keeps bottles in place.



Top Drawer is equipped with a removable divider in solid oak. **Anti slip mats** in vanity units and storage cabinet drawers.



Wall hung furniture give a more modern look. Wooden bottom plate frames the furniture.



The plinth gives the furniture a solid built feeling. The front is removable for easy cleaning. Choose **floor standing** vanity with plinth or **wall hung** vanity.



4 x shapes of full cover ceramic basins to choose from. D-shaped basin 100 cm is shown on the above image. **Code no. 122W1**

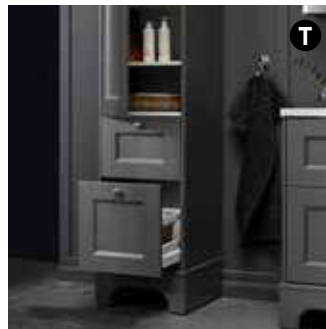

Practical storage solutions for you to choose from.



Drawers have straight insides which allows you to take advantage of the entire surface.



Bathroom Cabinet 60, 80, 100, 120 are equipped with a centre divider in wood that gives a more flexible placement of the glass shelves.



Dimmable Energy efficient top light with a neutral white light. Combine with matching down light. **Option code no. L102**

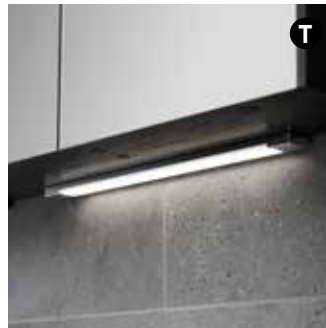

LED Down light that gives a white natural shine. **Option code no. DL2**



Linear LED Bathroom Cabinet dimmable lit bars. Energy efficient LED lighting with a white neutral sheen. Complete with **matching Down Light code no. DL2**.



Sides are slightly bevelled. Fronts are recessed.



Decorative **framed mirror doors** and fronts.



Integrated ceramic basin is one of the options for Kensington vanities.

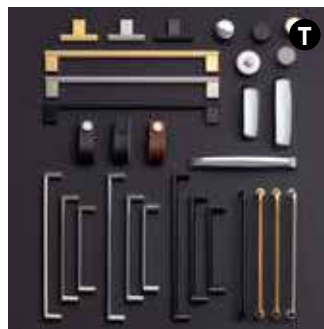

Handles and knobs. Choose between various finishes, shapes and sizes to create your personal touch. Page 147.

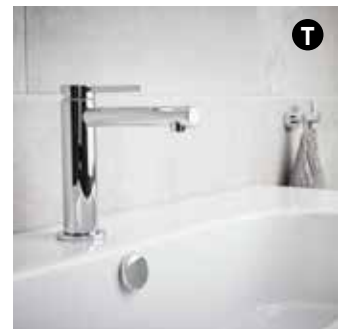

Taps. You can easily find a suitable and stylish favourite among our taps. Page 145.

KENSINGTON

Vanity units are fitted with mounting rails and brackets for easy adjustment and quick installation. Drawer fronts are adjustable in all directions. Fully extending drawers with soft close mechanism.

The drawers include an anti slip mat and removable wooden dividers in solid oak.

Lower drawers in vanities are equipped with a retaining bar. Vanity Units, basins, taps and handles are priced separately.

Choose between full cover basin, stone worktop with integrated basin or worktop with basin. All furniture is delivered fully assembled.

Read more about the Miller Way on www.millerbathrooms.co.uk

Colour

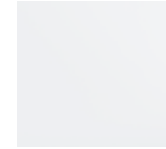

White



Dark Grey

60 / 80 / 100

Vanity with full cover ceramic basin

Size 60, 80, 100 - floorstanding or wall hung - price separately for vanity, basin and tap.

60 floorstanding	80 floorstanding	100 floorstanding
<p>Size vanity W610 x H802 x D458 mm Basin size see each model below</p>	<p>Size vanity W810 x H802 x D458 mm Basin size see each model below</p>	<p>Size vanity W1010 x H802 x D458 mm Basin size see each model below</p>
<p>Vanity floorstanding 2 drawers</p> <p>White 488-2 £1025</p> <p>Dark Grey 488-9 £1025</p> <p>Optional</p> <p>Handles page 147</p>	<p>Vanity floorstanding 2 drawers</p> <p>White 489-2 £1045</p> <p>Dark Grey 489-9 £1045</p> <p>Optional</p> <p>Handles page 147</p>	<p>Vanity floorstanding 2 drawers</p> <p>White 498-2 £1150</p> <p>Dark Grey 498-9 £1150</p> <p>Optional</p> <p>Handles page 147</p>
60 wall hung	80 wall hung	100 wall hung
<p>Size vanity W610 x H644 x D458 mm Basin size see each model below</p>	<p>Size vanity W810 x H644 x D458 mm Basin size see each model below</p>	<p>Size vanity W1010 x H644 x D458 mm Basin size see each model below</p>
<p>Vanity wall hung 2 drawers</p> <p>White 1488-2 £775</p> <p>Dark Grey 1488-9 £775</p> <p>Optional</p> <p>Handles page 147</p>	<p>Vanity wall hung 2 drawers</p> <p>White 1489-2 £835</p> <p>Dark Grey 1489-9 £835</p> <p>Optional</p> <p>Handles page 147</p>	<p>Vanity wall hung 2 drawers</p> <p>White 1498-2 £940</p> <p>Dark Grey 1498-9 £940</p> <p>Optional</p> <p>Handles page 147</p>
Basins		
<p>Basin for 60 vanity</p> <p>City 180W1 W605 x D455 mm £340</p> <p>D-shape 120W1 £340</p> <p>Rectangular 110W1 £340</p> <p>Velca 128W1 £340</p>	<p>Basin for 80 vanity</p> <p>City 181W1 W805 x D455mm £445</p> <p>D-shape 121W1 £445</p> <p>Rectangular 111W1 £445</p> <p>Velca 129W1 £445</p>	<p>Basin for 100 vanity</p> <p>City 182W1 W1005 x D455 mm £500</p> <p>D-shape 122W1 £500</p> <p>Rectangular 113W1 £500</p> <p>Velca 130W1 £500</p>

Ceramic Basins in several shapes

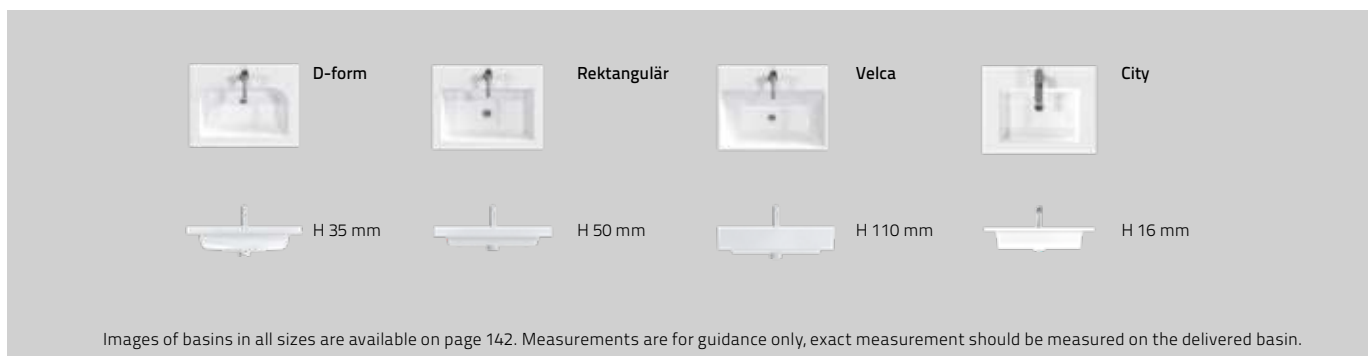

Vanity with stone worktop and integrated ceramic basin

Size 60, 80, 100 - floorstanding or wall hung - price separately for vanity, worktop with integrated ceramic basin and tap



Vanity floorstanding 2 drawers
 White **488-2T** £1025
 Dark Grey **488-9T** £1025
 Optional
 Handles page 147

Vanity floorstanding 2 drawers
 White **489-2T** £1045
 Dark Grey **489-9T** £1045
 Optional
 Handles page 147

Vanity floorstanding 2 drawers
 White **498-2T** £1150
 Dark Grey **498-9T** £1150
 Optional
 Handles page 147



Vanity wall hung 2 drawers
 White **1488-2T** £775
 Dark Grey **1488-9T** £775
 Optional
 Handles page 147

Vanity wall hung 2 drawers
 White **1489-2T** £835
 Dark Grey **1489-9T** £835
 Optional
 Handles page 147

Vanity wall hung 2 drawers
 White **1498-2T** £940
 Dark Grey **1498-9T** £940
 Optional
 Handles page 147

Choose stone worktop with integrated ceramic basin

Worktop for 60 vanity
 Marble **134W/600M** £1699
 Granite **134W/600G** £1599
 Diabase **134W/600D** £1699
 Green Marble **134W/600GM** £1699
 Jura **134W/600J** £1699
 Price incl.integrated ceramic basin
 Size worktop W595 x D455 x H30 mm

Worktop for 80 vanity
 Marble **134W/800M** £1799
 Granite **134W/800G** £1699
 Diabase **134W/800D** £1799
 Green Marble **134W/800GM** £1799
 Jura **134W/800J** £1799
 Price incl.integrated ceramic basin
 Size worktop W795 x D455 x H30 mm

Worktop for 100 vanity
 Marble **134W/1000M** £1899
 Granite **134W/1000G** £1799
 Diabase **134W/1000D** £1899
 Green Marble **134W/1000GM** £1899
 Jura **134W/1000J** £1899
 Price incl.integrated ceramic basin
 Size worktop W995 x D455 x H30 mm



Total size work top W595 x D455 x H30 mm
 Ceramic W490 x D320 mm. Max depth bowl 160 mm

Total size work top W795 x D455 x H30 mm
 Ceramic W490 x D320 mm. Max depth bowl 160 mm

Total size work top W995 x D455 x H30 mm
 Ceramic W490 x D320 mm. Max depth bowl 160 mm

Genuine stone worktop 30 mm with integrated ceramic basin

Up to 6 weeks delivery

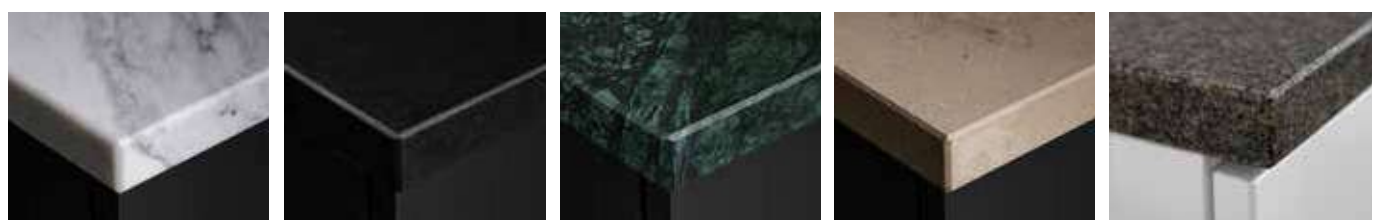

Carrara Marble

Black Diabase

Green Marble

Limestone Jura

Grey Swedish Granite

Vanity with work top and basin, tap mounted on the basin

Size 60, 80, 100 - floorstanding or wall hung - price separately for vanity, basin and tap.



60 floorstanding



Size vanity W610 x H802 x D458 mm
Basin size see each model below

80 floorstanding



Size vanity W810 x H802 x D458 mm
Basin size see each model below

100 floorstanding

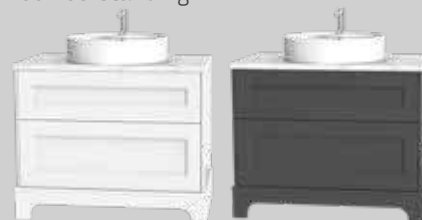

Size vanity W1010 x H802 x D458 mm
Basin size see each model below

Vanity unit floorstanding 2 drawers
White **488-2T** £1025
Dark Grey **488-9T** £1025
Optional
Handles page 147

Vanity unit floorstanding 2 drawers
White **489-2T** £1045
Dark Grey **489-9T** £1045
Optional
Handles page 147

Vanity unit floorstanding 2 drawers
White **498-2T** £1150
Dark Grey **498-9T** £1150
Optional
Handles page 147



60 wall hung



Size vanity W610 x H644 x D458 mm
Basin size see each model below

80 wall hung



Size vanity W810 x H644 x D458 mm
Basin size see each model below

100 wall hung



Size vanity W1010 x H644 x D458 mm
Basin size see each model below

Vanity unit wall hung 2 drawers
White **1488-2T** £775
Dark Grey **1488-9T** £775
Optional
Handles page 147

Vanity unit wall hung 2 drawers
White **1489-2T** £835
Dark Grey **1489-9T** £835
Optional
Handles page 147

Vanity unit wall hung 2 drawers
White **1498-2T** £940
Dark Grey **1498-9T** £940
Optional
Handles page 147

Worktop

Worktop for 60 vanity

Marble **600M** £620
Granite **600G** £620
Diabase **600D** £720
Green Marble **600GM** £620
Jura **600J** £620
Royal Reef **600R** £465
Black Tebas **600N** £465

Size worktop W595 x D455 mm
For height see each work top

Worktop for 80 vanity

Marble **800M** £720
Granite **800G** £720
Diabase **800D** £825
Green Marble **800GM** £720
Jura **800J** £720
Royal Reef **800R** £495
Black Tebas **800N** £495

Size worktop W795 x D455 mm
For height see each work top

Worktop for 100 vanity

Marble **1000M** £825
Granite **1000G** £825
Diabase **1000D** £979
Green Marble **1000GM** £825
Jura **1000J** £825
Royal Reef **1000R** £565
Black Tebas **1000N** £565

Size worktop W995 x D455 mm
For height see each work top

Genuine stone worktop 30 mm

Up to 6 weeks delivery



Grey Granite
Height 30 mm



Carrara Marble
Height 30 mm



Black Diabase
Height 30 mm



Green Marble
Height 30 mm



Limestone - Jura
Height 30 mm



Royal Reef
Height 20 mm



Black Tebas
Height 20 mm

Worktop quartz stone 20 mm

Up to 8 weeks delivery

Ceramic basins in four shapes

116W1 £470
117W1 £500
171W1 £299
173W1 £299

For more information on each basin
please see page 142.

116W1



W500 x D495 x H180 mm

117W1



W680 x D500 x H180 mm

171W1



Ø460 x H130 mm

173W1



W550 x H130 x D450 mm



Vanity with work top and basin, column tap mounted on the worktop

Size 60, 80, 100 - floorstanding or wall hung - price separately for vanity, basin and tap.



Vanity unit floorstanding 2 drawers
 White **488-2T** £1025
 Dark Grey **488-9T** £1025
 Optional
 Handles page 147

Vanity unit floorstanding 2 drawers
 White **489-2T** £1045
 Dark Grey **489-9T** £1045
 Optional
 Handles page 147

Vanity unit floorstanding 2 drawers
 White **498-2T** £1150
 Dark Grey **498-9T** £1150
 Optional
 Handles page 147



Vanity unit wall hung 2 drawers
 White **1488-2T** £775
 Dark Grey **1488-9T** £775
 Optional
 Handles page 147

Vanity unit wall hung 2 drawers
 White **1489-2T** £835
 Dark Grey **1489-9T** £835
 Optional
 Handles page 147

Vanity unit wall hung 2 drawers
 White **1498-2T** £940
 Dark Grey **1498-9T** £940
 Optional
 Handles page 147

Worktop

Worktop for 60 vanity
 Marble **600M-X** £620
 Granite **600G-X** £620
 Diabase **600D-X** £720
 Green Marble **600GM-X** £620
 Jura **600J-X** £620
 Royal Reef **600R-X** £465
 Black Tebas **600N-X** £465
 Size worktop W595 x D455 mm
 For height see each worktop

Worktop for 80 vanity
 Marble **800M-X** £720
 Granite **800G-X** £720
 Diabase **800D-X** £825
 Green Marble **800GM-X** £720
 Jura **800J-X** £720
 Royal Reef **800R-X** £495
 Black Tebas **800N-X** £495
 Size worktop W795 x D455 mm
 For height see each worktop

Worktop for 100 vanity
 Marble **1000M-X** £825
 Granite **1000G-X** £825
 Diabase **1000D-X** £979
 Green Marble **1000GM-X** £825
 Jura **1000J-X** £825
 Royal Reef **1000R-X** £565
 Black Tebas **1000N-X** £565
 Size worktop W995 x D455 mm
 For height see each worktop

NOTE -X, choose hole pattern, ex. 600M-V is a 60 cm marble worktop with tap hole to the left of the basin
 ex. 600D-H is a 60 cm diabase worktop with tap hole to the right of the basin



Ceramic basins



Only column taps are suitable for these washbasins: 1941C, 1941MP, 1941B.

Measurements are for guidance only, exact measurement should be measured on the delivered basin.

KENSINGTON STORAGE recessed decorative framed doors and drawers

Fitted with mounting rails and brackets for easy adjustment and quick installation. Soft closing doors and drawers. V stands for left hand door and H stands for right hand door (see sketch). All furniture is delivered fully assembled.

Read more about the Miller Way on www.millerbathrooms.co.uk

<p>Tall Cabinet with 2 drawers floorstanding</p> <p>1 fixed and 2 adjustable wood shelves 2 drawers, bottom drawer with retaining bar</p>  <p>W420 x H1786 x D391 mm</p> <p><i>Left hand door</i> White 492V-2 £1330 Dark Grey 492V-9 £1330</p> <p><i>Right hand door</i> White 492H-2 £1330 Dark Grey 492H-9 £1330</p> <p><i>Optional</i> Handles page 147</p>	<p>Tall Cabinet with door storage and 2 drawers floorstanding</p> <p>1 fixed and 2 adjustable wood shelves 2 drawers, bottom drawer with retaining bar</p>  <p>W420 x H1786 x D391 mm</p> <p><i>Left hand door</i> White 495V-2 £1550 Dark Grey 495V-9 £1550</p> <p><i>Right hand door</i> White 495H-2 £1550 Dark Grey 495H-9 £1550</p> <p><i>Optional</i> Handles page 147</p>	<p>Storage Cabinet</p> <p>1 fixed and 2 adjustable glass shelves</p>  <p>W320 x H1138 x D265 mm</p> <p><i>Left hand door</i> White 496V-2 £520 Dark Grey 496V-9 £520</p> <p><i>Right hand door</i> White 496H-2 £520 Dark Grey 496H-9 £520</p> <p><i>Optional</i> Handles page 147</p>
--	---	---

<p>Tall Cabinet with 2 drawers wall hung</p> <p>1 fixed and 2 adjustable wood shelves 2 drawers, bottom drawer with retaining bar</p>  <p>W420 x H1628 x D391 mm</p> <p><i>Left hand door</i> White 1492V-2 £1045 Dark Grey 1492V-9 £1045</p> <p><i>Right hand door</i> White 1492H-2 £1045 Dark Grey 1492H-9 £1045</p> <p><i>Optional</i> Handles page 147</p>	<p>Tall Cabinet with door storage and 2 drawers wall hung</p> <p>1 fixed and 2 adjustable wood shelves 2 drawers, bottom drawer with retaining bar</p>  <p>W420 x H1628 x D391 mm</p> <p><i>Left hand door</i> White 1495V-2 £1330 Dark Grey 1495V-9 £1330</p> <p><i>Right hand door</i> White 1495H-2 £1330 Dark Grey 1495H-9 £1330</p> <p><i>Optional</i> Handles page 147</p>
--	---

OPTIONAL

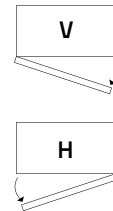

Choose between a right or left hand door on your storage cabinet. See sketch above. V is for left hand door and H is right hand door in the code no.



Handles and knobs. Choose between various finishes, shapes and sizes to create your personal touch. See page 147.

Colours

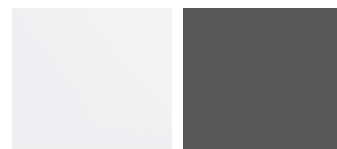

White

Dark Grey



NEW YORK

40, 60, 80, 100, 120 cm

Smooth doors and drawers



Sharp and minimalist elegance. Stylish, clean surfaces give a clear reflection of the modern mans quest for simple beauty and harmony. Just like the city with the same name, this collection is filled with endless choices. Vanity units are available in different widths and in several colours. The careful details such as the soft closure, the thin basin, the practical storage, the beautiful finish - these all create a special feeling for your bathroom which you will want to retain forever.

New York 100
Mirror Cabinet 55-4
Vanity 298-4
Basin 130W1
Tap 1936C
Storage 296V-4, 297H-4
Accessories Bond Brass



Double storage cabinets 293V-5 and 294H-4. Accessories Boston.



Down light DL2 provides fine lighting above the basin and tap.



40 Linear Led Mirror 59L with dimmable LED lighting. Down Light DL2. Accessories Bond black.



40 Linear Led Mirror Cabinet 52HL-4, dimmable LED lighting. Optional down light DL2.



Storage Cabinet 297 Practical door storage. 1 fixed wood shelf for stability and 2 adjustable glass shelves.



Tall Cabinet 293 1 fixed wood shelf for stability and 4 adjustable wood shelves. Choose right or left hand door.



Shallow vanity unit with doors and lots of storage space.



Smart storage for the smaller bathroom. Mirror 59-2, vanity unit 284H-2, basin 165W1, tap 1937C.



New York 60, Vanity 288-2



New York 120
Vanity 266-4
Mirror Cabinet 56-4G
Top Light L102
Down Light DL2
Basin 123W1
Tap 1936C
Accessories Boston

Smooth style doors and drawer fronts available in natural oak, black stained oak, smooth white painted and white structure. Soft closing drawers and doors. The drawers are sturdy, fully expandable and fitted with anti-slip mats. Vanity unit top drawers have compartments in solid natural oak that can easily be lifted out for cleaning. The furniture is delivered fully assembled.

Vanity unit bottom drawers are fitted with an adjustable bar to stop larger items from moving. For your vanity you can choose between a full cover basin or a worktop with basin. See options below. Complete the look with our range of taps and handles to add your own finished character to the bathroom furniture.

Colour

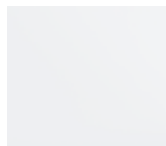

White



Black Stained Oak

Drawer Vanity sizes 60 / 80 / 100 / 120



- Drawer Vanity in 3 ways:
1. Drawer Vanity with full cover basin
 2. Drawer Vanity with worktop, basin and tap mounted on the worktop
 3. Drawer Vanity with worktop and tap mounted on the basin

Door Vanity sizes 40 / 60



- Door Vanity in 4 ways:
1. 35 cm shallow vanity, W400 mm
 2. Door Vanity with worktop, W400 mm
 3. 35 cm shallow vanity, W600 mm

Full Cover Ceramic Basin in several shapes



Basin for worktop, tap mounted on the worktop



Basin for worktop, tap mounted on the basin



Stone Work top

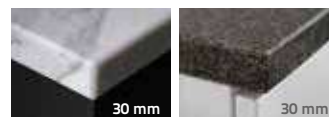

Carrara Marble

Grey Granite

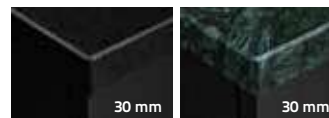

Black Diabase

Green Marble

Limestone



Jura

Work top Quartz Stone

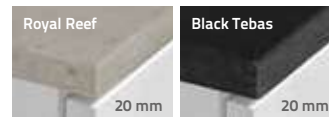

Quartz

Quartz



Our bathroom furniture has a 10 year guarantee

DETAILS NEW YORK

Symbol shows that this feature is optional. **T**



Fully extendable, soft closing drawers. Tall drawers and lower drawer in the double vanity are equipped with an adjustable retaining bar that keeps bottles in place.



Top drawers are equipped with an adjustable divider in wood.



Anti slip mats in vanity units and storage cabinet drawers.



Drawers have straight insides which allows you to take advantage of the entire surface.



35 mm thin full cover basin in genuine white ceramic. D-shaped range. One of our many basin options.



Practical storage solutions.



Stool with decorative legs that slides under vanity units with full cover basins. Practical and stylish at the same time.



Bathroom Cabinet 60, 80, 100, 120 are equipped with a centre divider in wood that gives a more flexible placement of the glass shelves.



Energy efficient top light in chrome finish. Neutral white light. **Option code no. L102**



LED Down light to match top light. **Option code no. DL2**



Linear LED Bathroom Cabinet dimmable lit bars. Energy efficient LED lighting with a white neutral sheen. **Complete with matching Down Light code no. DL2.**



Linear LED mirrors - in several sizes to match our vanities. **Complete with matching Down Light code no. DL2.**



Our bathroom furniture has a 10 year guarantee.



40/60 Many door vanity combinations to choose from, with worktops or full cover basins.

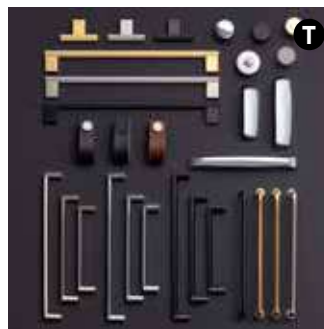

Handles and knobs. Choose between various finishes, shapes and sizes to create your personal touch. **Page 147.**

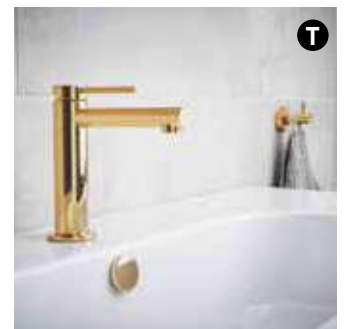

Taps. You can easily find a suitable and stylish favourite among our taps on **page 145.**

NEW YORK

Vanity units are fitted with mounting rails and brackets for easy adjustment and quick installation. Drawer fronts are adjustable in all directions. Fully extending drawers with soft close mechanism. The drawers include an anti slip mat and removable wooden dividers.

Vanity units, basins, taps and handles are priced separately. Double and high vanity units are equipped with a retaining bar.

Choose between full cover basin or worktop with basin. All furniture is delivered fully assembled.

Read more about the Miller Way on www.millerbathrooms.co.uk

Colour

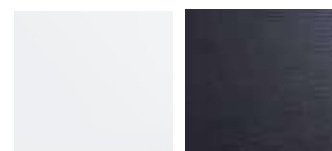





White Smooth

Black Stained Oak

40 / 60 / 80 / 100 / 120

Vanity with full cover basin

1 tall drawer or 2 drawers - price separately for vanity, basin and tap

60 Double	80 Double	100 Double	120 Double
			
Vanity size W590 x H580 x D455 mm Basin size see each model below	Vanity size W790 x H580 x D455 mm Basin size see each model below	Vanity size W990 x H580 x D455 mm Basin size see each model below	Vanity size W1190 x H580 x D455 mm Basin size see each model below
<i>Vanity Unit 2 drawers</i>	<i>Vanity Unit 2 drawers</i>	<i>Vanity Unit 2 drawers</i>	<i>Vanity Unit 4 drawers</i>
White 288-2 £655	White 289-2 £700	White 298-2 £775	White 266-2 £1350
Black 288-4 £795	Black 289-4 £840	Black 298-4 £915	Black 266-4 £1600
<i>Optional Handles</i> page 147	<i>Optional Handles</i> page 147	<i>Optional Handles</i> page 147	<i>Optional Handles</i> page 147
Basin			
<i>Basin for 60 vanity unit</i> W605 x D455 mm	<i>Basin for 80 vanity unit</i> W805 x D455 mm	<i>Basin for 100 vanity unit</i> W1005 x D455 mm	<i>Basin for 120 vanity unit with 2 bowls</i> W1210 x D455 mm
D-shape 120W1 £340	D-shape 121W1 £445	D-shape 122W1 £500	D-shape 123W1 £755
Rectangular 110W1 £340	Rectangular 111W1 £445	Rectangular 113W1 £500	Rectangular 115W1 £755
Oval 124W1 £340	Oval 125W1 £445	Oval 126W1 £500	Oval 127W1 £755
Velca 128W1 £340	Velca 129W1 £445	Velca 130W1 £500	Velca 131W1 £755
City* 180W1 £340	City* 181W1 £445	City* 182W1 £500	City* 183W1 £755
*City basin W610 x D466 mm	*City basin W812 x D466 mm	*City basin W1013 x D466 mm	*City basin W1217 x D470 mm

Ceramic Basins in several shapes

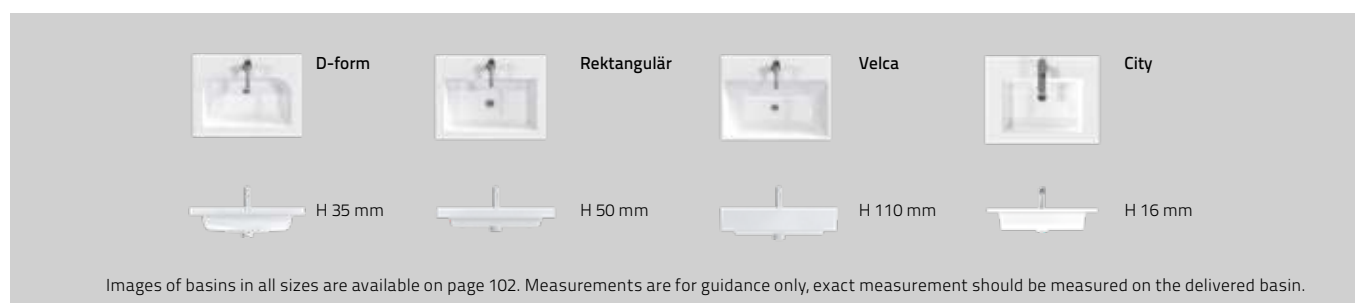

Vanity with doors

Size 40 or 60 cm - price separately for vanity, basin and tap



Left hand door

White **284V-2** £389
Black **284V-4** £485

Right hand door

White **284H-2** £389
Black **284H-4** £485

Basin

White **165W1** £255

Optional

Handles page 147

Colour Vanity

Black **286-4** £650

Basin

White **166W1** £290

Optional

Handles page 147

Left hand door

White **284V-2T** £389
Black **284V-4T** £485

Right hand door

White **284H-2T** £389
Black **284H-4T** £485

Basin

White **174W1** £210
White **135W** £300

Optional

Handles page 147

Colour worktop for 40 + 1 Door code 284

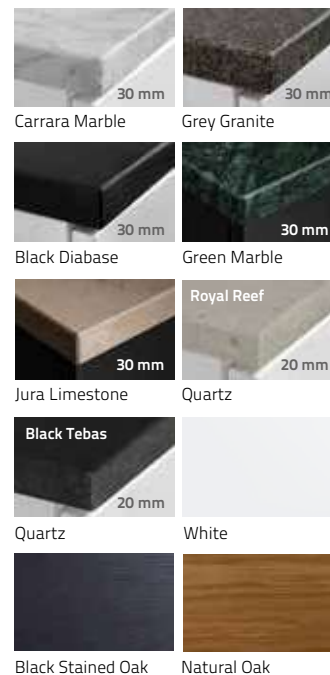

25 mm worktop for 40 vanity with door

White **79-2** £68
Black **79-4** £110
Oak **79-5** £110

30 mm worktop for 40 vanity with door

Marble **400M** £499
Granite **400G** £499
Diabase **400D** £540
Green Marble **400GM** £499
Jura **400J** £499

20 mm worktop for 40 vanity with door



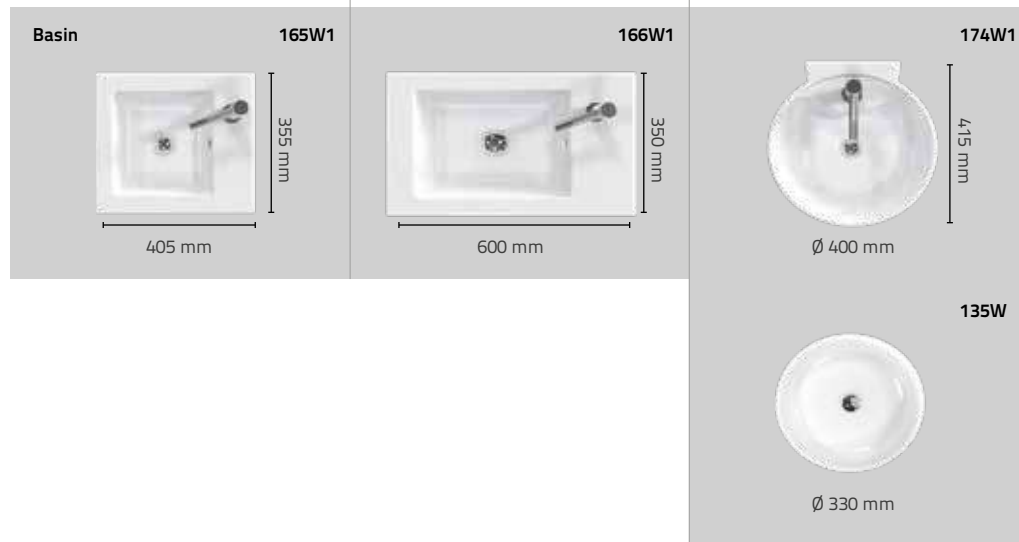

Royal Reef **400R** £295
Black Tebas **400N** £295





Size worktop W403 x D358 mm

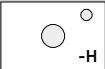

Drawer Vanity with worktop, basin and tap mounted on the worktop

Size 60, 80, 100, 120 - price separately for vanity, basin and tap

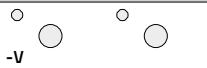
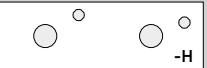
60 Double	80 Double	100 Double	120 Double
			
Size vanity W590 x H580 x D448 mm Size of basin see each model below	Size vanity W790 x H580 x D448 mm Size of basin see each model below	Size vanity W990 x H580 x D448 mm Size of basin see each model below	Size vanity W1180 x H580 x D448 mm Size of basin see each model below
Vanity Unit 2 drawers White 288-2T £655 Black 288-4T £795 <i>Optional</i> Handles page 147	Vanity Unit 2 drawers White 289-2T £720 Black 289-4T £840 <i>Optional</i> Handles page 147	Vanity Unit 2 drawers White 298-2T £775 Black 298-4T £915 <i>Optional</i> Handles page 147	Vanity Unit 4 drawers White 266-2T £1350 Black 266-4T £1600 <i>Optional</i> Handles page 147
Choose Worktop <i>Worktop for 60 vanity</i> Marble 600M-X £620 Granite 600G-X £620 Diabase 600D-X £720 Green Marble 600GM-X £620 Jura 600J-X £620 Royal Reef 600R-X £465 Black Tebas 600N-X £465 <i>Size worktop W595 x D455</i>	<i>Worktop for 80 vanity</i> Marble 800M-X £720 Granite 800G-X £720 Diabase 800D-X £825 Green Marble 800GM-X £720 Jura 800J-X £720 Royal Reef 800R-X £495 Black Tebas 800N-X £495 <i>Size worktop W795 x D455 mm</i>	<i>Worktop for 100 vanity</i> Marble 1000M-X £825 Granite 1000G-X £825 Diabase 1000D-X £979 Green Marble 1000GM-X £825 Jura 1000J-X £825 Royal Reef 1000R-X £565 Black Tebas 1000N-X £565 <i>Size worktop W995 x D455 mm</i>	<i>Worktop for 120 vanity</i> Marble 1200M-X £1029 Granite 1200G-X £1029 Diabase 1200D-X £1239 Green Marble 1200GM-X £1029 Jura 1200J-X £1029 Royal Reef 1200R-X £895 Black Tebas 1200N-X £895 <i>Size worktop W1200 x D455 mm</i>

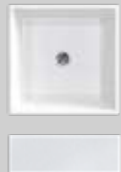
Choose Hole Pattern	Basins
<i>NOTE -X, choose below hole pattern i.e. 600M-V is a 60 cm marble work top with tap hole to the left of the basin.</i>	
<p>hole to the right -H</p>  <p>add -H after the work top code no. example: 600M-H</p> <p>hole to the left -V</p>  <p>add -V after the work top code no. example: 600M-V</p> <p>120 vanity left + right -HV</p>  <p>example: 1200M-HV</p> <p>120 vanity to the left -V</p>  <p>example: 1200M-V</p> <p>120 vanity to the right -H</p>  <p>example: 1200M-H</p>	<p>Basins</p> <p>136W £330</p>  <p>hole to the right -H</p> <p>hole to the left -V</p> <p>Ø390 x H140 mm Max.depth bowl 100 mm</p> <p>133W £315</p>  <p>hole to the right -H</p> <p>hole to the left -V</p> <p>Ø390 x H150 mm Max.depth bowl 130 mm</p> <p>132W £315</p>  <p>hole to the right -H</p> <p>hole to the left -V</p> <p>W390 x D390 x H130 mm Max.depth bowl 95 mm</p>

Drawer Vanity with worktop, basin and tap mounted on the basin

Size 60, 80, 100, 120 - price separately for vanity, basin and tap



Vanity Unit 2 drawers

White **288-2T** £655
Black **288-4T** £795

Optional

Handles page 147

Choose Worktop

Worktop for 60 vanity

Marble **600M** £620
Granite **600G** £620
Diabase **600D** £720
Green Marble **600GM** £620
Jura **600J** £620
Royal Reef **600R** £465
Black Tebas **600N** £465
Size worktop W595 x D455

Vanity Unit 2 drawers

White **289-2T** £700
Black **289-4T** £840

Optional

Handles page 147

Worktop for 80 vanity

Marble **800M** £720
Granite **800G** £720
Diabase **800D** £825
Green Marble **800GM** £720
Jura **800J** £720
Royal Reef **800R** £495
Black Tebas **800N** £495
Size worktop W795 x D455 mm

Vanity Unit 2 drawers

White **298-2T** £775
Black **298-4T** £915

Optional

Handles page 147

Worktop for 100 vanity

Marble **1000M** £825
Granite **1000G** £825
Diabase **1000D** £979
Green Marble **1000GM** £825
Jura **1000J** £825
Royal Reef **1000R** £565
Black Tebas **1000N** £565
Size worktop W995 x D455 mm

Vanity Unit 4 drawers

White **266-2T** £1350
Black **266-4T** £1600

Optional

Handles page 147

Worktop for 120 vanity

Marble **1200M** £1029
Granite **1200G** £1029
Diabase **1200D** £1239
Green Marble **1200GM** £1029
Jura **1200J** £1029
Royal Reef **1200R** £895
Black Tebas **1200N** £895
Size worktop W1200 x D455 mm

Stone worktop 30 mm

Up to 6 weeks delivery



Grey Granite



Carrara Marble



Black Diabase



Green Marble



Jura



Royal Reef



Svart Tebas

Limestone

Up to 6 weeks delivery

Worktop quartz stone 20 mm

Up to 8 weeks delivery

Ceramic basins in four shapes

116W1 £470
117W1 £500
171W1 £299
173W1 £299

Measurements of each basin is available on millerbathrooms.co.uk

116W1



W500 x D495 x H180 mm

117W1



W680 x D500 x H180 mm

171W1



Ø460 x H180 mm

173W1







W550 x H130 x D450 mm

Taps Choose between several models and colours see page 145.

NEW YORK STORAGE smooth doors and drawers

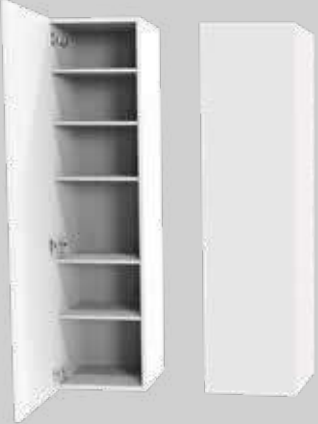
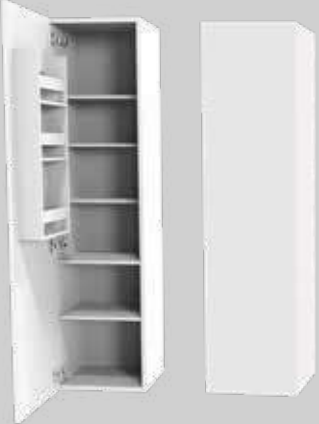
Fitted with mounting rails and brackets for easy adjustment and quick installation. Soft closing doors and drawers. V stands for left hand door and H stands for right hand door (see sketch). All furniture is delivered fully assembled.

Read more about the Miller Way on www.millerbathrooms.co.uk

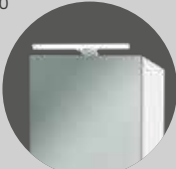
<p>Tall Cabinet</p> <p>1 fixed and 4 adjustable wood shelves</p>  <p>W400 x H1690 x D380 mm</p> <p><i>Left hand door</i></p> <table border="0"> <tr> <td>White</td> <td>293V-2</td> <td>£835</td> </tr> <tr> <td>Black</td> <td>293V-4</td> <td>£1100</td> </tr> </table> <p><i>Right hand door</i></p> <table border="0"> <tr> <td>White</td> <td>293H-2</td> <td>£835</td> </tr> <tr> <td>Black</td> <td>293H-4</td> <td>£1100</td> </tr> </table> <p><i>Optional Handles</i> page 147</p>	White	293V-2	£835	Black	293V-4	£1100	White	293H-2	£835	Black	293H-4	£1100	<p>Tall Cabinet with door storage</p> <p>1 fixed and 4 adjustable wood shelves Door storage with 3 shelves</p>  <p>W400 x H1690 x D380 mm</p> <p><i>Left hand door</i></p> <table border="0"> <tr> <td>White</td> <td>294V-2</td> <td>£975</td> </tr> <tr> <td>Black</td> <td>294V-4</td> <td>£1355</td> </tr> </table> <p><i>Right hand door</i></p> <table border="0"> <tr> <td>White</td> <td>294H-2</td> <td>£975</td> </tr> <tr> <td>Black</td> <td>294H-4</td> <td>£1355</td> </tr> </table> <p><i>Optional Handles</i> page 147</p>	White	294V-2	£975	Black	294V-4	£1355	White	294H-2	£975	Black	294H-4	£1355	<p>Tall Cabinet with 2 drawers</p> <p>1 fixed and 3 adjustable wood shelves 2 drawers, bottom drawer with retaining bar</p>  <p>W400 x H1690 x D380 mm</p> <p><i>Left hand door</i></p> <table border="0"> <tr> <td>White</td> <td>291V-2</td> <td>£975</td> </tr> <tr> <td>Black</td> <td>291V-4</td> <td>£1300</td> </tr> </table> <p><i>Right hand door</i></p> <table border="0"> <tr> <td>White</td> <td>291H-2</td> <td>£975</td> </tr> <tr> <td>Black</td> <td>291H-4</td> <td>£1300</td> </tr> </table> <p><i>Optional Handles</i> page 147</p>	White	291V-2	£975	Black	291V-4	£1300	White	291H-2	£975	Black	291H-4	£1300
White	293V-2	£835																																				
Black	293V-4	£1100																																				
White	293H-2	£835																																				
Black	293H-4	£1100																																				
White	294V-2	£975																																				
Black	294V-4	£1355																																				
White	294H-2	£975																																				
Black	294H-4	£1355																																				
White	291V-2	£975																																				
Black	291V-4	£1300																																				
White	291H-2	£975																																				
Black	291H-4	£1300																																				
<p>Storage Cabinet</p> <p>1 fixed and 2 adjustable glass shelves</p>  <p>W400 x H1111 x D255 mm</p> <p><i>Left hand door</i></p> <table border="0"> <tr> <td>White</td> <td>296V-2</td> <td>£570</td> </tr> <tr> <td>Black</td> <td>296V-4</td> <td>£750</td> </tr> </table> <p><i>Right hand door</i></p> <table border="0"> <tr> <td>White</td> <td>296H-2</td> <td>£570</td> </tr> <tr> <td>Black</td> <td>296H-4</td> <td>£750</td> </tr> </table> <p><i>Optional Handles</i> page 147</p>	White	296V-2	£570	Black	296V-4	£750	White	296H-2	£570	Black	296H-4	£750	<p>Storage Cabinet with door storage</p> <p>1 fixed and 2 adjustable glass shelves Door storage with 3 shelves</p>  <p>W400 x H1111 x D255 mm</p> <p><i>Left hand door</i></p> <table border="0"> <tr> <td>White</td> <td>297V-2</td> <td>£750</td> </tr> <tr> <td>Black</td> <td>297V-4</td> <td>£925</td> </tr> </table> <p><i>Right hand door</i></p> <table border="0"> <tr> <td>White</td> <td>297H-2</td> <td>£750</td> </tr> <tr> <td>Black</td> <td>297H-4</td> <td>£925</td> </tr> </table> <p><i>Optional Handles</i> page 147</p>	White	297V-2	£750	Black	297V-4	£925	White	297H-2	£750	Black	297H-4	£925	<p>Mirror Cabinet with double sided mirror door</p> <p>1 fixed and 2 adjustable glass shelves, Frosted 20 mm edge at the opening on the outside Shown with optional top light L102</p>  <p>W400 x H1111 x D242 mm</p> <p><i>Left hand door</i></p> <table border="0"> <tr> <td>White</td> <td>96V-2</td> <td>£595</td> </tr> <tr> <td>Black</td> <td>96V-4</td> <td>£750</td> </tr> </table> <p><i>Right hand door</i></p> <table border="0"> <tr> <td>White</td> <td>96H-2</td> <td>£595</td> </tr> <tr> <td>Black</td> <td>96H-4</td> <td>£750</td> </tr> </table> <p><i>Optional Top Light</i> L102 £130</p> <p>Optional - This mirror cabinet is prepared for LED top light L102 £130</p> 	White	96V-2	£595	Black	96V-4	£750	White	96H-2	£595	Black	96H-4	£750
White	296V-2	£570																																				
Black	296V-4	£750																																				
White	296H-2	£570																																				
Black	296H-4	£750																																				
White	297V-2	£750																																				
Black	297V-4	£925																																				
White	297H-2	£750																																				
Black	297H-4	£925																																				
White	96V-2	£595																																				
Black	96V-4	£750																																				
White	96H-2	£595																																				
Black	96H-4	£750																																				

Storage Cabinet

1 fixed wooden shelf

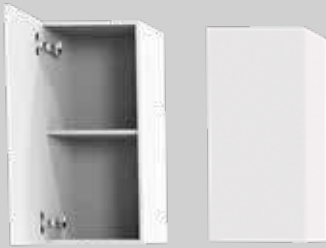

W275 x H590 x D221 mm

Left hand door

White **234V-2** £320
Black **234V-4** £420

Right hand door

White **234H-2** £320
Black **234H-4** £420

Optional

Handles page 147

Storage Cabinet

1 fixed divider
You cannot choose right/left-hand door.

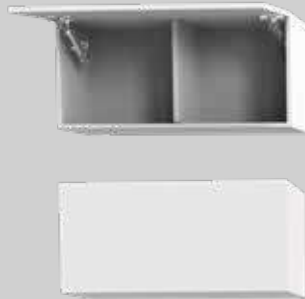

W590 x H275 x D221 mm

Flap door opens up

White **1250-2** £320
Black **1250-4** £420

Optional

Handle page 147

OPTIONAL

Handles



Handles and knobs. Choose between various finishes, shapes and sizes to create your personal touch. See page 147.

Right or Left Hand Door?

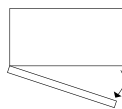

V = Left hand door

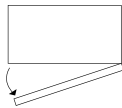

H = Right hand door

Choose between a right or left hand door on your storage cabinet. See sketch above. V is for left hand door and H is right hand door in the code no.

Colours

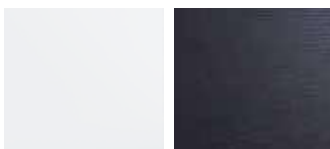

White

Black Stained Oak

LONDON

40, 60, 80, 100, 120 cm

Framed doors and drawer fronts



Classic beauty. Tasteful setting of drawers and fronts which enhances and deepens the impression of refined art. Inviting, clean lines with a beautiful finish that makes this collection obviously welcome in today's bathrooms. With the experience we have we know that all bathrooms are different - just like humans, so London is available in various sizes and in classic colours. The attention to the smallest detail adds to the comfort and knowledge that feeling nice, like beauty, is timeless.

London 120
Mirror 63-5
Vanity Unit 566-5
Basin 123W1
Taps 1936C



Doors and drawers are 19 mm and gives a solid impression. Natural oak and Black stained oak are made of solid oak.



D-shaped ceramic basin 120 cm with double bowls. Also available in 60, 80, and 100 cm. Modern still classic handle in chrome 93803.



With different handles, you easily put your personal touch.



London is available in a sober grey colour that fits nicely with chrome details and Carrara Marble worktop.



Vanity 40 584H-5T, Basin 174W1, Tap 1935C, Oak Worktop 79-5.



Vanity 40, a smart solution for a smaller cloak room, only 35 cm deep. Accessories Montana.



Vanity 80 589-5, Rectangular Basin 111W1, Tap 1940MP.
Accessories Bond.



Vanity 60 588-5 with D-shaped basin 120W1, Handle 3004-160C.

Framed doors and drawer fronts are available in natural oak and light grey.

Soft closing drawers and doors. The drawers are sturdy, fully expandable and fitted with anti-slip mats. Vanity unit top drawers have compartments in solid natural oak that can easily be lifted out for cleaning. Vanity unit bottom drawers are fitted with an adjustable bar to stop larger items from moving.

For your vanity you can choose between a full cover basin or a worktop with basin. See options below.

Complete the look with our range of taps and handles to add your own finished character to the bathroom furniture.

The furniture is delivered fully assembled.

Colours



Light Grey



Natural Oak

Drawer Vanity sizes 60 / 80 / 100 / 120



1. Drawer Vanity with full cover basin
2. Drawer Vanity with worktop, basin and tap mounted on the worktop
3. Drawer Vanity with worktop and tap mounted on the basin

Door Vanity sizes 40 / 60



Door Vanity in 4 ways:

1. 35 cm shallow vanity, W400 mm
2. Door Vanity with worktop, W400 mm
3. 35 cm shallow vanity, W600 mm

Full Cover Ceramic Basin in several shapes

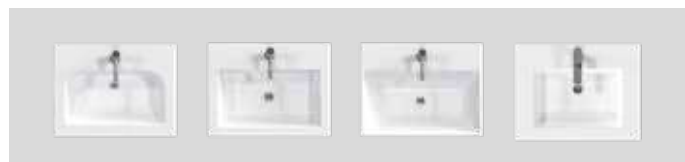

Basin for worktop, tap mounted on the worktop



Basin for worktop, tap mounted on the basin



Stone Work top

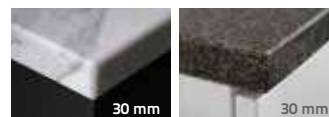

Carrara Marble

Grey Granite

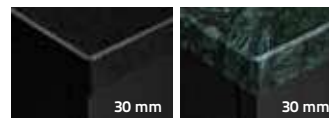

Black Diabase

Green Marble

Limestone



Jura

Work top Quartz Stone

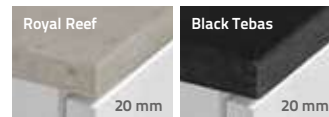

Quartz

Quartz



Our bathroom furniture has a 10 year guarantee

DETAILS LONDON

Symbol shows that this feature is optional. **T**



Top drawers are equipped with an adjustable divider in wood.



Anti slip mats in vanity units and storage cabinet drawers.



Drawers have straight insides which allows you to take advantage of the entire surface.



Fully extendable, soft closing drawers. Tall drawers and lower drawer in the double vanity are equipped with an adjustable retaining bar that keeps bottles in place.



35 mm thin fullcover basin in genuine white ceramic. D-shaped range. One of many basin options.



Practical storage solutions.



Matching Storage Our cabinets are available in several sizes and colours customized to optimize your storage.



Bathroom Cabinet 60, 80, 100, 120 are equipped with a centre divider in wood that gives a more flexible placement of the glass shelves.



Energy efficient top light in chrome finish. Neutral white light. **Option code no. L102**



LED Down light to match top light. **Option code no. DL2**



Linear LED Bathroom Cabinet dimmable lit bars. Energy efficient LED lighting with a white neutral sheen. Complete with **matching Down Light code no. DL2.**



Doors and drawers are 19 mm and gives a solid impression. Natural Oak and Black Stained Oak are solid oak.

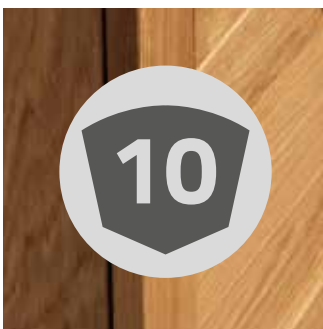

Our bathroom furniture has a 10 year guarantee.



Light grey is one of two colours. It goes well with chrome details and Carrara marble.

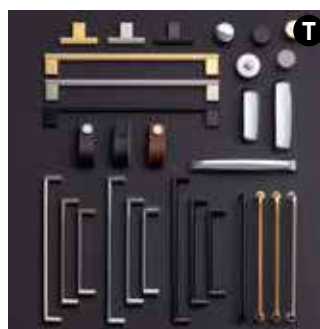

Handles and knobs. Choose between various finishes, shapes and sizes to create your personal touch. **Page 147.**



Taps. You can easily find a suitable and stylish favourite among our taps on **page 145.**

LONDON

Vanity units are fitted with mounting rails and brackets for easy adjustment and quick installation. Drawer fronts are adjustable in all directions. Fully extending drawers with soft close mechanism. The drawers include an anti slip mat and removable wooden dividers.

Vanity Units, basins, taps and handles are priced separately. Double and high vanity units are equipped with a retaining bar.

Choose between full cover basin or worktop with basin. All furniture is delivered fully assembled.

Read more about the Miller Way on www.millerbathrooms.co.uk

Colour

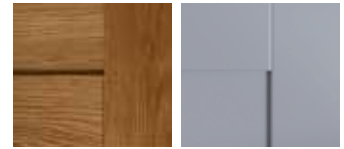





Natural Oak

Light Grey

40 / 60 / 80 / 100 / 120



Vanity with full cover basin

1 tall drawer or 2 drawers - price separately for vanity, basin and tap

60 Double	80 Double	100 Double	120 Double
			
Vanity size W590 x H580 x D455 mm Basin size see each model below	Vanity size W790 x H580 x D455 mm Basin size see each model below	Vanity size W990 x H580 x D455 mm Basin size see each model below	Vanity size W1190 x H580 x D455 mm Basin size see each model below
Vanity Unit 2 drawers Light Grey 588-8 £710 Oak 588-5 £840 <i>Optional Handles</i> page 147	Vanity Unit 2 drawers Oak 589-5 £925 <i>Optional Handles</i> page 147	Vanity Unit 2 drawers Light Grey 598-8 £825 Oak 598-5 £975 <i>Optional Handles</i> page 147	Vanity Unit 4 drawers Oak 566-5 £1750 <i>Optional Handles</i> page 147
Basin <i>Basin for 60 vanity unit</i> W605 x D455 mm D-shape 120W1 £340 Rectangular 110W1 £340 Velca 128W1 £340 City* 180W1 £340 *City basin W610 x D466 mm	<i>Basin for 80 vanity unit</i> W805 x D455 mm D-shape 121W1 £445 Rectangular 111W1 £445 Velca 129W1 £445 City* 181W1 £445 *City basin W812 x D466 mm	<i>Basin for 100 vanity unit</i> W1005 x D455 mm D-shape 122W1 £500 Rectangular 113W1 £500 Velca 130W1 £500 City* 182W1 £500 *City basin W1013 x D466 mm	<i>Basin for 120 vanity unit with 2 bowls</i> W1210 x D455 mm D-shape 123W1 £755 Rectangular 115W1 £755 Velca 131W1 £755 City* 183W1 £755 *City basin W1217 x D470 mm

Shallow Vanity with doors

Size 40 or 60 cm - price separately for vanity, basin and tap

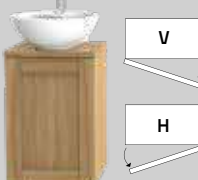
40 + 1 Door	60 + 2 Doors	40 + 1 Door + Worktop
		
Total size W405 x H630 x D350 mm	Total size W600 x H630 x D350 mm	Total size W405 x H755 x D350 mm Basin depth 415 mm
<i>Left hand door</i> Light Grey 584V-8 £415 Oak 584V-5 £525 <i>Right hand door</i> Light Grey 584H-8 £415 Oak 584H-5 £525 <i>Basin</i> White 165W1 £255 <i>Optional Handles</i> page 147	<i>Colour Vanity</i> Light Grey 586-8 £489 Oak 586-5 £650 <i>Basin</i> White 166W1 £290 <i>Optional Handles</i> page 147	<i>Left hand door</i> Light Grey 584V-8T £415 Oak 584V-5T £525 <i>Right hand door</i> Light Grey 584H-8T £415 Oak 584H-5T £525 <i>Basin</i> White 174W1 £210 White 135W £300 <i>Optional Handles</i> page 147

Worktop for 40 + 1, code 584-

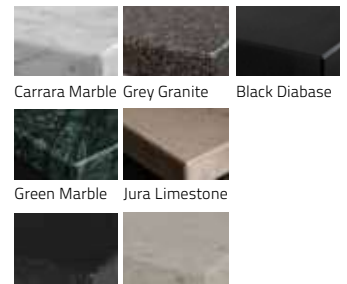





Carrara Marble Grey Granite Black Diabase
Green Marble Jura Limestone
Quartz Black Tebas Quartz Royal Reef

25 mm worktop for 40 vanity with door
White **79-2** £68
Light Grey **79-8** £68
Oak **79-5** £110



30 mm worktop for 40 vanity with door
Marble **400M** £499
Granite **400G** £499
Diabase **400D** £540
Green Marble **400GM** £499
Jura **400J** £499

20 mm worktop for 40 vanity with door
Royal Reef **400R** £295
Black Tebas **400N** £295
Size worktop W403 x D358 mm

Basin	Basin	Basin	Basin
			
165W1 405 mm 355 mm	166W1 600 mm 350 mm	174W1 Ø 400 mm 415 mm	135W Ø 330 mm

Drawer Vanity with worktop, basin and tap mounted on the worktop

Size 60, 80, 100, 120 - price separately for vanity, basin and tap

60 Double	80 Double	100 Double	120 Double
			
Size vanity W590 x H580 x D448 mm Size of basin see each model below	Size vanity W790 x H580 x D448 mm Size of basin see each model below	Size vanity W990 x H580 x D448 mm Size of basin see each model below	Size vanity W1180 x H580 x D448 mm Size of basin see each model below
Vanity Unit 2 drawers Light Grey 588-8T £710 Oak 588-5T £840 <i>Optional Handles</i> page 147	Vanity Unit 2 drawers Oak 589-5T £925 <i>Optional Handles</i> page 147	Vanity Unit 2 drawers Light Grey 598-8T £825 Oak 598-5T £975 <i>Optional Handles</i> page 147	Vanity Unit 4 drawers Oak 566-5T £1750 <i>Optional Handles</i> page 147
Choose Worktop <i>Worktop for 60 vanity</i> Marble 600M-X £620 Granite 600G-X £620 Diabase 600D-X £720 Green Marble 600GM-X £620 Jura 600J-X £620 Royal Reef 600R-X £465 Black Tebas 600N-X £465 <i>Size worktop W595 x D455</i>	<i>Worktop for 80 vanity</i> Marble 800M-X £720 Granite 800G-X £720 Diabase 800D-X £825 Green Marble 800GM-X £720 Jura 800J-X £720 Royal Reef 800R-X £495 Black Tebas 800N-X £495 <i>Size worktop W795 x D455 mm</i>	<i>Worktop for 100 vanity</i> Marble 1000M-X £825 Granite 1000G-X £825 Diabase 1000D-X £979 Green Marble 1000GM-X £825 Jura 1000J-X £825 Royal Reef 1000R-X £565 Black Tebas 1000N-X £565 <i>Size worktop W995 x D455 mm</i>	<i>Worktop for 120 vanity</i> Marble 1200M-X £1029 Granite 1200G-X £1029 Diabase 1200D-X £1239 Green Marble 1200GM-X £1029 Jura 1200J-X £1029 Royal Reef 1200R-X £895 Black Tebas 1200N-X £895 <i>Size worktop W1200 x D455 mm</i>

Stone worktop 30 mm

Up to 6 weeks delivery



Grey Granite

Carrara Marble

Black Diabase

Green Marble

Limestone

Up to 6 weeks delivery



Jura







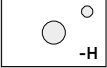
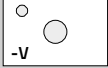

Worktop quartz stone 20 mm

Up to 8 weeks delivery



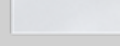

Royal Reef

Svart Tebas

Choose Hole Pattern	Basins
<p>NOTE -X, choose below hole pattern i.e. 600M-V is a 60 cm marble work top with tap hole to the left of the basin.</p> <p>hole to the right -H  add -H after the work top code no. example: 600M-H</p> <p>hole to the left -V  add -V after the work top code no. example: 600M-V</p> <p>120 vanity left + right  -HV example: 1200M-HV</p> <p>120 vanity to the left -V  -V example: 1200M-V</p> <p>120 vanity to the right -H  -H example: 1200M-H</p>	<p>Basins</p> <p>136W £330   Ø390 x H140 mm Max.depth bowl 100 mm</p> <p>133W £315   Ø390 x H150 mm Max.depth bowl 130 mm</p> <p>132W £315   W390 x D390 x H130 mm Max.depth bowl 95 mm</p>

Drawer Vanity with worktop, basin and tap mounted on the basin

Size 60, 80, 100, 120 - price separately for vanity, basin and tap

60 Double	80 Double	100 Double	120 Double
			
Size vanity W590 x H580 x D448 mm Size of basin see each model below	Size vanity W790 x H580 x D448 mm Size of basin see each model below	Size vanity W990 x H580 x D448 mm Size of basin see each model below	Size vanity W1180 x H580 x D448 mm Size of basin see each model below
Vanity Unit 2 drawers Light Grey 588-8T £710 Oak 588-5T £840 <i>Optional Handles</i> page 147	Vanity Unit 2 drawers Oak 589-5T £925 <i>Optional Handles</i> page 147	Vanity Unit 2 drawers Light Grey 598-8T £825 Oak 598-5T £975 <i>Optional Handles</i> page 147	Vanity Unit 4 drawers Oak 566-5T £1750 <i>Optional Handles</i> page 147
Choose Worktop <i>Worktop for 60 vanity</i> Marble 600M £620 Granite 600G £620 Diabase 600D £720 Green Marble 600GM £620 Jura 600J £620 Royal Reef 600R £465 Black Tebas 600N £465 <i>Size worktop W595 x D455</i>	<i>Worktop for 80 vanity</i> Marble 800M £720 Granite 800G £720 Diabase 800D £825 Green Marble 800GM £720 Jura 800J £720 Royal Reef 800R £495 Black Tebas 800N £495 <i>Size worktop W795 x D455 mm</i>	<i>Worktop for 100 vanity</i> Marble 1000M £825 Granite 1000G £825 Diabase 1000D £979 Green Marble 1000GM £825 Jura 1000J £825 Royal Reef 1000R £565 Black Tebas 1000N £565 <i>Size worktop W995 x D455 mm</i>	<i>Worktop for 120 vanity</i> Marble 1200M £1029 Granite 1200G £1029 Diabase 1200D £1239 Green Marble 1200GM £1029 Jura 1200J £1029 Royal Reef 1200R £895 Black Tebas 1200N £895 <i>Size worktop W1200 x D455 mm</i>

Stone worktop 30 mm

Up to 6 weeks delivery



Grey Granite



Carrara Marble



Black Diabase



Green Marble



Jura



Royal Reef



Svart Tebas

Limestone

Up to 6 weeks delivery

Worktop quartz stone 20 mm

Up to 8 weeks delivery

Ceramic basins in four shapes

116W1	£470
117W1	£500
171W1	£299
173W1	£299

Measurements of each basin is available on millerbathrooms.co.uk

116W1



W500 x D495 x H180 mm

117W1



W680 x D500 x H180 mm

171W1



Ø460 x H180 mm

173W1



W550 x H130 x D450 mm

Taps Choose between several models and colours see page 145.

LONDON STORAGE OPTIONS

Handles



Handles and knobs. Choose between various finishes, shapes and sizes to create your personal touch. See page 147.

Right or Left Hand Door?

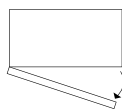

V = Left hand door

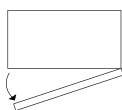

H = Right hand door

Choose between a right or left hand door on your storage cabinet. See sketch above. V is for left hand door and H is right hand door in the code no.

Colours



Light Grey



Natural Oak

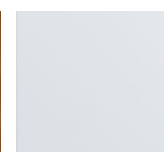

White
96V/H-X cabinet only

LONDON STORAGE framed doors and drawers

Fitted with mounting rails and brackets for easy adjustment and quick installation. Soft closing doors and drawers. V stands for left hung door and H stands for right hung door (see sketch). All furniture is delivered fully assembled.

Read more about the Miller Way on www.millerbathrooms.co.uk

Tall Cabinet

1 fixed and 4 adjustable wood shelves



B400 x H1690 x D380 mm

Left hand door

Light Grey **593V-8** £855
Oak **593V-5** £1200

Right hand door

Light Grey **593H-8** £855
Oak **593H-5** £1200

Optional

Handles page 147

Tall Cabinet with door storage

1 fixed and 4 adjustable wood shelves
Door storage with 3 shelves



B400 x H1690 x D380 mm

Left hand door

Light Grey **594V-8** £970
Oak **594V-5** £1315

Right hand door

Light Grey **594H-8** £970
Oak **594H-5** £1315

Optional

Handles page 147

Storage Cabinet

1 fixed and 2 adjustable glass shelves



B400 x H1111 x D255 mm

Left hand door

Light Grey **596V-8** £570
Oak **596V-5** £715

Right hand door

Light Grey **596H-8** £570
Oak **596H-5** £715

Optional

Handles page 147

Storage Cabinet with door storage

1 fixed and 2 adjustable glass shelves
Door storage with 3 shelves



B400 x H1111 x D255 mm

Left hand door

Light Grey **597V-8** £790
Oak **597V-5** £950

Right hand door

Light Grey **597H-8** £790
Oak **597H-5** £950

Optional

Handles page 147

Mirror Cabinet with double sided mirror door

1 fixed and 2 adjustable glass shelves,
Frosted 20 mm edge at the opening on the outside
Shown with optional top light L102



B400 x H1111 x D242 mm

Left hung door

White **96V-2** £595
Oak **96V-5** £775

Right hung door

White **96H-2** £595
Oak **96H-5** £775

Optional

Top Light **L102** £130

Optional - This mirror cabinet is prepared for LED top light **L102** £130

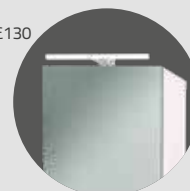

MIRROR CABINET LINEAR LED

Integrated dimmable light with touch sensor. Technically powerful LED light creates illuminated lines with better colour reproduction. Perfect for makeup. IP44 rated. Fitted with mounting rails and brackets for adjustable & quick installation. Soft closing double sided mirror doors. Choose left or right hand door for the 40 bathroom cabinet, see illustration below. All furniture is delivered fully assembled.

Read more about the Miller Way on www.millerbathrooms.co.uk

Colours

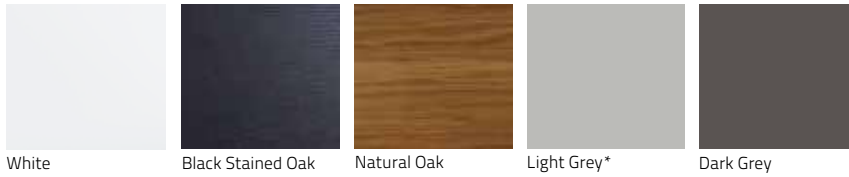

40 / 60 / 80 / 100

For Furniture Ranges:
Kensington, New York, London

40 linear led



W404 x H700 x D145 m

2 x glass shelves, IP44

Left hand door

White	52VL-2	£625
Black	52VL-4	£785
Oak	52VL-5	£785
Light Grey*	52VL-8	£625

Right hand door

White	52HL-2	£625
Black	52HL-4	£785
Oak	52HL-5	£785
Light Grey*	52HL-8	£625

Optional

Down Light	DL2	£79
2 extra glass shelves	54-190	£21

60 linear led



W590 x H700 x D145 mm

4 x glass shelves, centre wood divider, IP44

White	53L-2	£820
Black	53L-4	£985
Oak	53L-5	£985
Light Grey*	53L-8	£820
Dark Grey	53L-9	£890

Optional

Down Light	DL2	£79
2 extra glass shelves	53-190	£19

Optional Kensington furniture

Decorative top white	06-453-2	£35
Decorative top dark Grey	06-453-9	£35

80 linear led



W790 x H700 x D145 mm

4 x glass shelves, centre wood divider, IP44

White	54L-2	£920
Black	54L-4	£1065
Oak	54L-5	£1065
Light Grey*	54L-8	£920
Dark Grey	54L-9	£1015

Optional

Down Light	DL2	£79
2 extra glass shelves	54-190	£21

Optional Kensington furniture

Decorative top white	06-454-2	£40
Decorative top dark Grey	06-454-9	£40

100 linear led

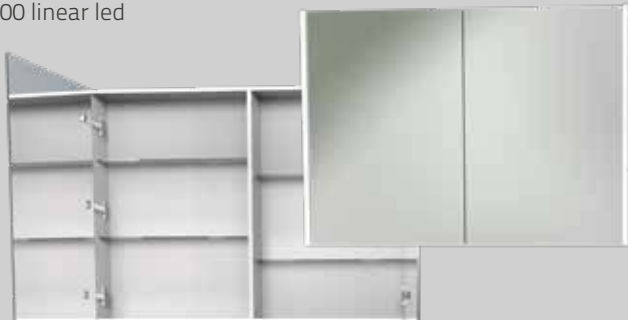

W990 x H700 x D145 mm

4 x glass shelves, centre wood divider, IP44

White	55L-2	£940
Black	55L-4	£1120
Oak	55L-5	£1120
Light Grey*	55L-8	£940
Dark Grey	55L-9	£1070

Optional

Down Light	DL2	£79
2 extra glass shelves	55-190	£23

Optional Kensington furniture

Decorative top white	06-455-2	£45
Decorative top dark Grey	06-455-9	£45

*Only the sides are Light Grey, inside of the cabinets are white painted.

DETAILS



Centre divider in wood for stability and a more flexible placement of the shelves.



Light shines both forward and inward on cabinets.



Control the brightness with a touch sensor. Our new Bathroom Cabinet memorises the latest desired brightness when switched on and off.



The lighting is integrated in the sides of the bathroom cabinets and measures 16 mm x 16 mm. Matching Down Light DL2.



For Bathroom Collection Kensington we offer a Decorative Top made of wood to fix on top of the Linear Led Mirror Cabinets. See Optional for Kensington: 60, 80 and 100 Linear Led.

OPTIONAL



Down Light Linear Led

Size W350 x H10 x D24 mm

Chrome DL2 £79
Chrome finish. White neutral sheen. IP44. Dimmable with Linear Led Mirror Cabinet.

Can only be combined with Linear Led Mirror Cabinet, Linear Led Mirrors and Linead Led Top Light L102.



Extra glass shelves

For right size please see optional under each bathroom cabinet. Shelf brackets are included.



Decorative Top

For our Bathroom Collection Kensington we offer a Decorative Top in wood to match the vanities.

These are only available for Mirror Cabinets 60, 80 and 100 cm. Same size as the Kensington vanities. In Colours White and Dark Grey.

MIRROR CABINET with thin wooden frame

You choose if you want Top and Down Light to your Mirror Cabinet. There are two different models of Top and Down lights. Product images below are shown with Top Light L102. Price separately for Mirror Cabinet and Top/Down Light.

Fitted with mounting rails and brackets for adjustable & quick installation. Soft closing double sided mirror doors. Choose left or right hung door for the 40 bathroom cabinet, see illustration below. All furniture is delivered fully assembled.

Read more about the Miller Way on www.millerbathrooms.co.uk

Colours



White

Black Stained Oak

Natural Oak

Light Grey*

Dark Grey

40 / 60 / 80 / 100

For Furniture Ranges:
Kensington, New York, London

40 Mirror Cabinet



W404 x H700 x D145 mm

2 x glass shelves

Left hand door

White **52V-2G** £420

Black **52V-4G** £525

Oak **52V-5G** £525

Light Grey **52V-8G** £420

Right hand door

White **52H-2G** £420

Black **52H-4G** £525

Oak **52H-5G** £525

Light Grey **52H-8G** £420

Optional

Top Light **L102** £130

Down Light **DL2** £79

2 extra glass shelves **54-190** £21

60 Mirror Cabinet



W590 x H700 x D145 mm

4 x glass shelves, centre divider in wood

White **53-2G** £580

Black **53-4G** £745

Oak **53-5G** £745

Light Grey **53-8G** £580

Dark Grey **53-9G** £580

Optional

Top Light **L102** £130

Down Light **DL2** £79

2 extra glass shelves **53-190** £19

80 Mirror Cabinet



W790 x H700 x D145 mm

4 x glass shelves, centre divider in wood

White **54-2G** £675

Black **54-4G** £825

Oak **54-5G** £825

Light Grey **54-8G** £675

Dark Grey **54-9G** £675

Optional

Top Light **L102** £130

Down Light **DL2** £79

2 extra glass shelves **54-190** £21

100 Mirror Cabinet

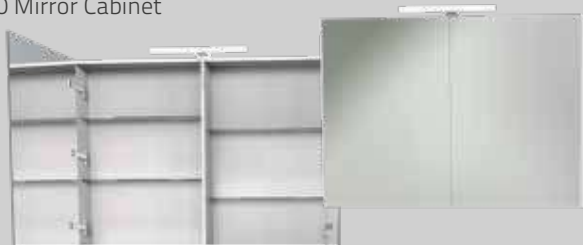

W990 x H700 x D145 mm

4 x glass shelves, centre divider in wood

1 extra hinge for stability

White **55-2G** £725

Black **55-4G** £900

Oak **55-5G** £900

Light Grey **55-8G** £725

Dark Grey **55-9G** £725

Optional

Top Light **L102** £130

Down Light **DL2** £79

2 extra glass shelves **55-190** £23

120 Mirror Cabinet



W1180 x H700 x D145 mm
Choose 2 top/down lights

8 x glass shelves, 2 x 60 cabinets

Double centre divider in wood

White **56-2G** £1170

Black **56-4G** £1545

Oak **56-5G** £1545

Light Grey* **56-8G** £1170

Optional

Top Light **L102** £130

Down Light **DL2** £79

2 extra glass shelves **53-190** £19

MIRROR CABINET with thin wooden frame

DETAILS



Dimmer via the "DIM" sensor located at the bottom / end of the right light profile. Press and hold your finger against the sensor to increase / decrease the amount of light and release the sensor when you have reached desired amount of light. The cabinet will then remember the last set brightness when you turn on the cabinet next time.

Thin wooden edge along the sides of the cabinets. Mirror Cabinet 120 is shown above with Linear Led Top and Down Light, code no. L102 and DL2.

OPTIONAL MIRROR CABINET



Top Light Linear Led

Chrome **L102** £130
White neutral sheen. IP44.
Dimmable.
1 top light fits 40, 60, 80 and 100.
Choose 2 top lights for 120.



Down Light Linear Led

Size W350 x H10 x D24 mm
Chrome **DL2** £79
Chrome finish. White neutral sheen.
IP44. Dimmable with Top Light L102.

Can only be combined with Linear Led Mirror Cabinet, Linear Led Mirrors and Linear Led Top Light L102.



Extra glass shelves

For right size please see optional under each bathroom cabinet.
Shelf brackets are included.

MIRROR LINEAR LED

Integrated dimmable light with touch sensor. Technically powerful LED light creates illuminated lines with better colour reproduction. Perfect for makeup. IP44 rated. Down Light is available as an option for Linear Led Mirror. Fitted with mounting rails and brackets for adjustable & quick installation. All furniture is delivered fully assembled.

Read more about the Miller Way on www.millerbathrooms.co.uk

Colour



40 / 60 / 80 / 100

For Furniture Ranges:
Kensington, New York, London

Chrome/Mirror

40 linear led



W407 x H700 x D50 mm

Mirror with dimmable linear led lighting
Chrome

59L £445

Optional

Down Light **DL2** £79

60 linear led



W607 x H700 x D50 mm

Mirror with dimmable linear led lighting

Chrome **60L** £495

Optional

Down Light **DL2** £79

80 linear led

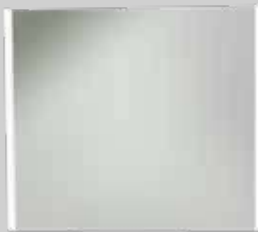

W807 x H700 x D50 mm

Mirror with dimmable linear led lighting

Chrome **61L** £545

Optional

Down Light **DL2** £79

100 linear led



W1007 x H700 x D50 mm

Mirror with dimmable linear led lighting

Chrome **62L** £595

Optional

Down Light **DL2** £79

DETAILS



Mirror 59L. Down Light DL2

Control the brightness with a touch sensor. Our new Bathroom Cabinet memorises the latest desired brightness when switched on and off.

OPTIONAL



Chrome **DL2** £79
Chrome finish. White neutral sheen.
IP44. Dimmable with Top Light L102.

Can only be combined with Linear Led Mirror Cabinet, Linear Led Mirrors and Linear Led Top Light L102.



Mirror 59L. Floating effect.

PLAIN MIRROR GLASS

4 mm mirror glass. Grade polished edge. Suspension bracket for easy mounting and floating effect.

Read more about the Miller Way on www.millerbathrooms.co.uk



40, 60, 80, 100, 120 CM

Optional: dimmable LED Top Light



Code no.	Product	Measurement W x H x D mm	Price
59-G	Plain Mirror Glass 40	400 x 700 x 10	£49.95
60-G	Plain Mirror Glass 60	590 x 700 x 10	£69.95
61-G	Plain Mirror Glass 80	790 x 700 x 10	£89.95
62-G	Plain Mirror Glass 100	990 x 700 x 10	£99.95
63-G	Plain Mirror Glass 120	1180 x 700 x 10	£119.95
L102	LED top light	L355 x D133, light .16 x 16	£130

We recomend 2 x L102 for 120 Mirror 63-G Mirror.



Top Light L102:

Control the brightness with a touch sensor. Our new Bathroom Cabinet memorises the latest desired brightness when switched on and off. White neutral light, Led color 4000K, IP44.

Easily mounted directly on the mirror glass.

(The driver is built in and connects directly to 230V.)

ROUND MIRROR GLASS

4 mm mirror glass. Grade polished edge. Suspension bracket for easy mounting and floating effect.

Read more about the Miller Way on www.millerbathrooms.co.uk

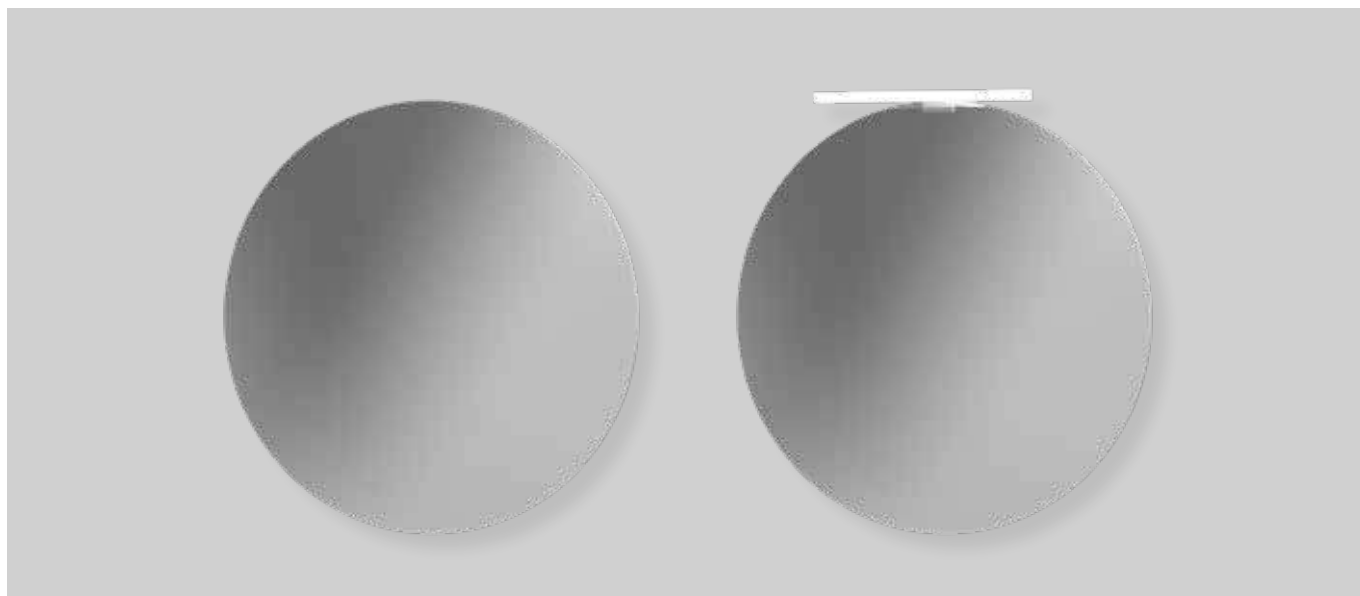

70, 90, 110 CM

Optional: dimmable LED Top Light



Code no.	Product	Measurement Ø x D mm	Price
R70-G	Round Mirror Glass 70	Ø70 x 10	£79.95
R90-G	Round Mirror Glass 90	Ø90 x 10	£129.95
R110-G	Round Mirror Glass 110	Ø110 x 10	£169.95
L102	LED top light	L355 x D133, light .16 x 16	£130



Top Light L102:

Control the brightness with a touch sensor. Our new Bathroom Cabinet memorises the latest desired brightness when switched on and off. White neutral light, Led color 4000K, IP44.

Easily mounted directly on the mirror glass.

(The driver is built in and connects directly to 230V.)

TRADITIONAL 1903

50 and 65 cm

Floorstanding or wall hung

Classic framed mirror doors and drawers



Back to beauty. The classic design creates a safe and warm feeling for your moments in the bathroom. Hand-worked details, bevelled mirrors and rounded arches along the English washbasin provide a luxurious and romantic feel to everyday life. Classic bathrooms - the Miller Way.

Bathroom Cabinet 353H-2
Light 301C-2
Vanity Unit 386-2
Basin 782W-1
Tap 19370C
Storage 394V-2
WC 788W/789W-C
Toilet Seat 348-2
Accessories Stockholm and Classic



Vanity Unit 386-2 with Basin 782W-1.



Classic Mirror Cabinet with bevelled mirror glass.



Floorstanding or wall hung vanities and storage cabinets.



Timeless bathroom accessories, Stockholm collection crafted from solid brass with a chrome finish.



Display Cabinet - bevelled clear glass, wooden shelves with decorative rounded edges.

Mirror 360C-2, light 301C-2, vanity unit 384H-2, basin 781W-1, tap 19370C, storage unit 394V-2, ceramic knobs 92794. Accessories Stockholm 680C, 611C, 613C, 606C. Vanity unit and storage unit is also available wall hung see page 74.





Traditional Mirror has a wooden shelf with chromed rails.



Detail of the Traditional 1903 Mirror, code no. 360C-2.



Storage Cabinet 394V-2 with wood panelled door and ceramic knob code no. 92794.



Floorstanding vanities and storage cabinets have a decorative base with adjustable feet.

FURNITURE COLLECTION TRADITIONAL 1903

50 / 65

Vanities are available floorstanding with plinth and adjustable feet or wall hung.

Vanity units are fitted with mounting rails and brackets for adjustable & quick installation. All furniture is delivered fully assembled.

Soft closing doors and drawers. 50 vanity units are available with left or right hung door.

Read more about the Miller Way on www.millerbathrooms.co.uk

50 cm Vanity with 1 door

Floorstanding or wall hung - price separately for vanity, basin and tap.

50 floorstanding	50 wall hung
	
W535 x H915 x D375 mm	W535 x H805 x D375 mm
<i>Vanity with 1 door</i>	<i>Vanity with 1 door</i>
<i>Left hand door</i>	<i>Left hand door</i>
White 384V-2 £970	White 1384V-2 £860
<i>Right hand door</i>	<i>Right hand door</i>
White 384H-2 £970	White 1384H-2 £860
<i>Basin</i>	<i>Basin</i>
White ceramic 781W-1 £475	White ceramic 781W-1 £475

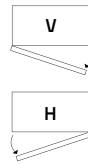

Colour

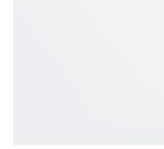

White

Please see our knobs and handles on page 147.

65 cm Vanity with doors or drawers

Floorstanding or wall hung - price separately for vanity, basin and tap.

65 floorstanding	65 wall hung
	
W655 x H930 x D510 mm	
<i>Vanity with 2 doors</i>	<i>Vanity with 2 doors</i>
White 386-2 £1135	White 1386-2 £1075
<i>Basin</i>	<i>Basin</i>
White ceramic 782W-1 £535	White ceramic 782W-1 £535

Cabinet *Arched frame with bevelled mirror glass alternatively panelled door in wood. 3 adjustable glass shelves. Bathroom cabinets are fitted with mounting rails and brackets for adjustable and quick installation.*

Mirror Cabinet	Cabinet
	
W494 x H706 x D194 mm	W494 x H706 x D194 mm
<i>Left hand door</i>	<i>Left hand door</i>
White 353V-2 £700	White 354V-2 £700
<i>Right hand door</i>	<i>Right hand door</i>
White 353H-2 £700	White 354H-2 £700

Mirror

Mirror with shelf

W471 x H698 x D162 mm
<i>Mirror with arched wooden frame and bevelled mirror glass. Fixed shelf with rail in chrome finish.</i>
White 360C-2 £425



Storage

Storage cabinets are available with plinth and adjustable feet or wall hung. Choose glass or wood panelled door. Storage cabinets are fitted with mounting rails and brackets for adjustable and quick installation. 1 fixed and 2 adjustable wood shelves. Wooden shelves have a decorative rounded front edge.

Storage cabinet floorstanding	Storage cabinet wall hung	Display cabinet floorstanding	Display cabinet wall hung
			
W439 x H1155 x D350 mm	W439 x H1125 x D350 mm	W439 x H1155 x D350 mm	W439 x H1125 x D350 mm
1 Panell Door Left hand door White 394V-2 £920 Right hand door White 394H-2 £920	1 Panell Door Left hand door White 1394V-2 £785 Right hand door White 1394H-2 £785	1 glass door with wood frame, tempered clear glass with bevelled edge Left hand door White 395V-2 £920 Right hand door White 395H-2 £920	1 glass door with wood frame, tempered clear glass with bevelled edge Left hand door White 1395V-2 £785 Right hand door White 1395H-2 £785





Ceramic, Pedestal, Tap and Lighting

Floorstanding or wall hung

Basin 55 and Pedestal	Basin 65 and Pedestal	WC Floorstanding	WC Wall hung
			
B535 x D375 x H870 mm	B655 x D510 x H920 mm	B400 x D690 x H803 mm	B388 x D550 x H375 mm
Basin and pedestal shown above in combination, genuine ceramic Basin 781W-1 £475 Pedestal 785W £345	Basin and pedestal shown above in combination, genuine ceramic. Basin 782W-1 £535 Pedestal 785W £345	Floor standing wc in white ceramic incl. tank and chrome flush button. Excl. seat. WC Floor standing 788W/789W-C £1065 Optional Seat white gloss like WC 348-2 £350	Wall hung wc in white ceramic. Excl. tank and seat. (Suitable for built in tank like Geberit Duofix.) WC Wall hung 794W £575 Optional Seat white gloss like WC 348-2 £350
Toilet seat white gloss	Classic tap	Bathroom light	
			
H105 mm	H105 mm	With back plate H280 x D350 mm Without back plate H255 x D320 mm	
Only fits 788W/798W-C and 794W. White gloss like the ceramic. Chrome fittings and a small handle on the right side of the lid. Soft closing lid and seat. White Gloss 348-2 £350	Delivered with pop up waste. Chrome 19370C £289	With or without wooden back plate, IP23. Chrome finished with frosted white globe Ø150 mm. Polished Nickel. With white back plate 301C-2 £225 Without back plate 301C £199	

CERAMIC

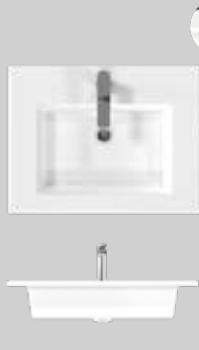
The basins are manufactured in genuine ceramic and therefore have a certain measurement tolerance. All measurements are for guidance only. Exact dimensions should be measured on each product you purchase before fitting. Technical drawings are available on www.millerbathrooms.co.uk. Three taphole and no taphole solutions on all fullcover basins possible.

<p>60 D-shape</p>  <p>120W 0 Tap Hole extended lead time on request £340 120W1 1 Tap Hole £340 W605 x H35 x D455 mm, max. depth bowl 135 mm</p>	<p>80 D-shape</p>  <p>121W 0 Tap Hole extended lead time on request £445 121W1 1 Tap Hole £445 W805 x H35 x D455 mm, max. depth bowl 135 mm</p>	<p>100 D-shape</p>  <p>122W 0 Tap Hole extended lead time on request £500 122W1 1 Tap Hole £500 W1005 x H35 x D455 mm, max. depth bowl 135 mm</p>
<p>60 Velca</p>  <p>128W 0 Tap Hole extended lead time on request £340 128W1 1 Tap Hole £340 W605 x H110 x D455 mm, max. depth bowl 135 mm</p>	<p>80 Velca</p>  <p>129W 0 Tap Hole extended lead time on request £445 129W1 1 Tap Hole £445 W805 x H110 x D455 mm, max. depth bowl 135 mm</p>	<p>100 Velca</p>  <p>130W 0 Tap Hole extended lead time on request £500 130W1 1 Tap Hole £500 W1005 x H110 x D455 mm, max. depth bowl 135 mm</p>
<p>60 Rectangular</p>  <p>110W 0 Tap Hole extended lead time on request £340 110W1 1 Tap Hole £340 W605 x H50 x D455 mm, max. depth bowl 100 mm</p>	<p>80 Rectangular</p>  <p>111W 0 Tap Hole extended lead time on request £445 111W1 1 Tap Hole £445 W805 x H50 x D455 mm, max. depth bowl 100 mm</p>	<p>100 Rectangular</p>  <p>113W 0 Tap Hole extended lead time on request £500 113W1 1 Tap Hole £500 W1005 x H50 x D455 mm, max. depth bowl 100 mm</p>
<p>60 City</p>  <p>180W 0 Tap Hole extended lead time on request £340 180W1 1 Tap Hole £340 W610 x H16 x D466 mm, max. depth bowl 105 mm</p>	<p>80 City</p>  <p>181W 0 Tap Hole extended lead time on request £445 181W1 1 Tap Hole £445 W812 x H16 x D466 mm, max. depth bowl 105 mm</p>	<p>100 City</p>  <p>182W 0 Tap Hole extended lead time on request £500 182W1 1 Tap Hole £500 W1013 x H16 x D466 mm, max. depth bowl 105 mm</p>













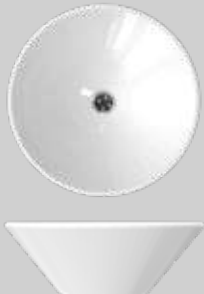



Three taphole and No taphole solutions on all fullcover basins possible. No taphole solutions extended leadtime on request. Three tap hole can be punched by a qualified installer choose W1 code no.

Basin 132W, 133W, 135W, 136W, 150W, 151W are basins that are mounted on a worktop. They are only suitable with taps 1941C, 1941B, 1941MP which is delivered with a fixed waste.

CERAMIC

All basins can be wall hung - except 132W, 133W, 135W, 136W, 150W, 151W, 171W1, 173W1. For wall hanging of basins, we recommend using suitable brackets as support - not included.

<p>120 D-shape </p>  <p>123W 0 Tap Hole extended lead time on request £755 123W1 1 Tap Hole £755 W1210 x H35 x D455 mm, max. depth bowl 135 mm</p>	<p>Tap placed on the worktop, or inside wall</p>  <p>135W £300 Ø330 x H125 mm, max. depth bowl 90 mm</p>	<p>Tap placed on the worktop, or inside wall</p>  <p>150W £330 Ø400/195 x H135 mm</p>
<p>120 Velca </p>  <p>131W 0 Tap Hole extended lead time on request £755 131W1 1 Tap Hole £755 W1210 x H110 x D450 mm, max. depth bowl 135 mm</p>	<p>Tap placed on the worktop, or inside wall</p>  <p>136W £330 Ø390 x H140 mm, max. depth bowl 100 mm</p>	<p>Tap placed on the worktop, or inside wall</p>  <p>150W £330 Ø400/195 x H135 mm</p>
<p>120 Rectangular </p>  <p>115W 0 Tap Hole extended lead time on request £755 115W1 1 Tap Hole £755 W1210 x H50 x D455 mm, max. depth bowl 100 mm</p>	<p>Tap placed on the worktop, or inside wall</p>  <p>133W £315 Ø395 x H150 mm, max. depth bowl 130 mm</p>	<p>Tap placed on the worktop, or inside wall</p>  <p>132W £315 W390 x D390 x H130 mm, max. depth bowl 95 mm</p>
<p>120 City </p>  <p>183W 0 Tap Hole extended lead time on request £755 183W1 1 Tap Hole £775 W1217 x H16 x D470 mm, maxdjup skål 105 mm</p>	<p>160 City </p>  <p>184W 0 Tap Hole extended lead time on request £1445 184W1 1 Tap Hole £1445 W1620 x H16 x D470 mm, maxdjup skål 105 mm</p>	<p>Cover Caps</p>  <p>Fits our full cover basins D-shape, Velca, Rectangular.</p> <p>110W1-190-A Brass coloured plastic £19 110W1-190-B Matt Black finish £19</p>

CERAMIC

The basins are manufactured in genuine ceramic and therefore have a certain measurement tolerance. All measurements are for guidance only. Exact dimensions should be measured on each product you purchase before fitting. Technical drawings are available on www.millerbathrooms.co.uk.

<p>174W1</p>  <p>174W1 Ø400x H150 x D415 mm</p> <p>£210</p>	<p>W405 x D355 mm</p>  <p>165W1 W405 x H50 x D355 mm</p> <p>£255</p>	<p>W600 x D350 mm</p>  <p>166W1 W600 x H50 x D355 mm</p> <p>£290</p>
<p>116W1</p>  <p>116W1 W500 x H180 x D495 mm</p> <p>£470</p>	<p>117W1</p>  <p>117W1 W680 x H180 x D500 mm</p> <p>£500</p>	<p>171W1</p>  <p>171W1 Ø460 x H130 mm</p> <p>£299</p>
<p>173W1</p>  <p>173W1 W550 x H130 x D450 mm</p> <p>£299</p>	<p>P134W</p>  <p>P134W undermount basin £365 Note Exact dimensions are measured on delivered product before making work top cut outs. W490 x D320 mm. Max depth bowl 160 mm</p>	<p>Basin 55 and Pedestal</p>  <p><i>Basin and pedestal shown above in combination, genuine ceramic.</i></p> <p>Basin 781W-1 £475 Pedestal 785W £345 W535 x D375 x H870 mm</p>
<p>Basin 65 and Pedestal</p>  <p><i>Basin and pedestal shown above in combination, genuine ceramic.</i></p> <p>Basin 782W-1 £535 Pedestal 785W £345 W655 x D510 x H920 mm</p>	<p>WC Floorstanding</p>  <p><i>Floor standing wc in white ceramic incl.tank, chrome flush button. Excl. seat.</i></p> <p>788W/789W-C £1065 <i>Contact us for seat suggestions</i></p> <p>W400 x D690 x H803 mm</p>	<p>WC wall hung</p>  <p><i>Wall hung wc in white ceramic. Excl. tank and seat. (Suitable for built in tank like Geberit Duofix.)</i></p> <p>WC Wall hung 794W £575 <i>Contact us for seat suggestions</i></p> <p>W388 x D550 x H375 mm</p>

HANDLES AND KNOBS

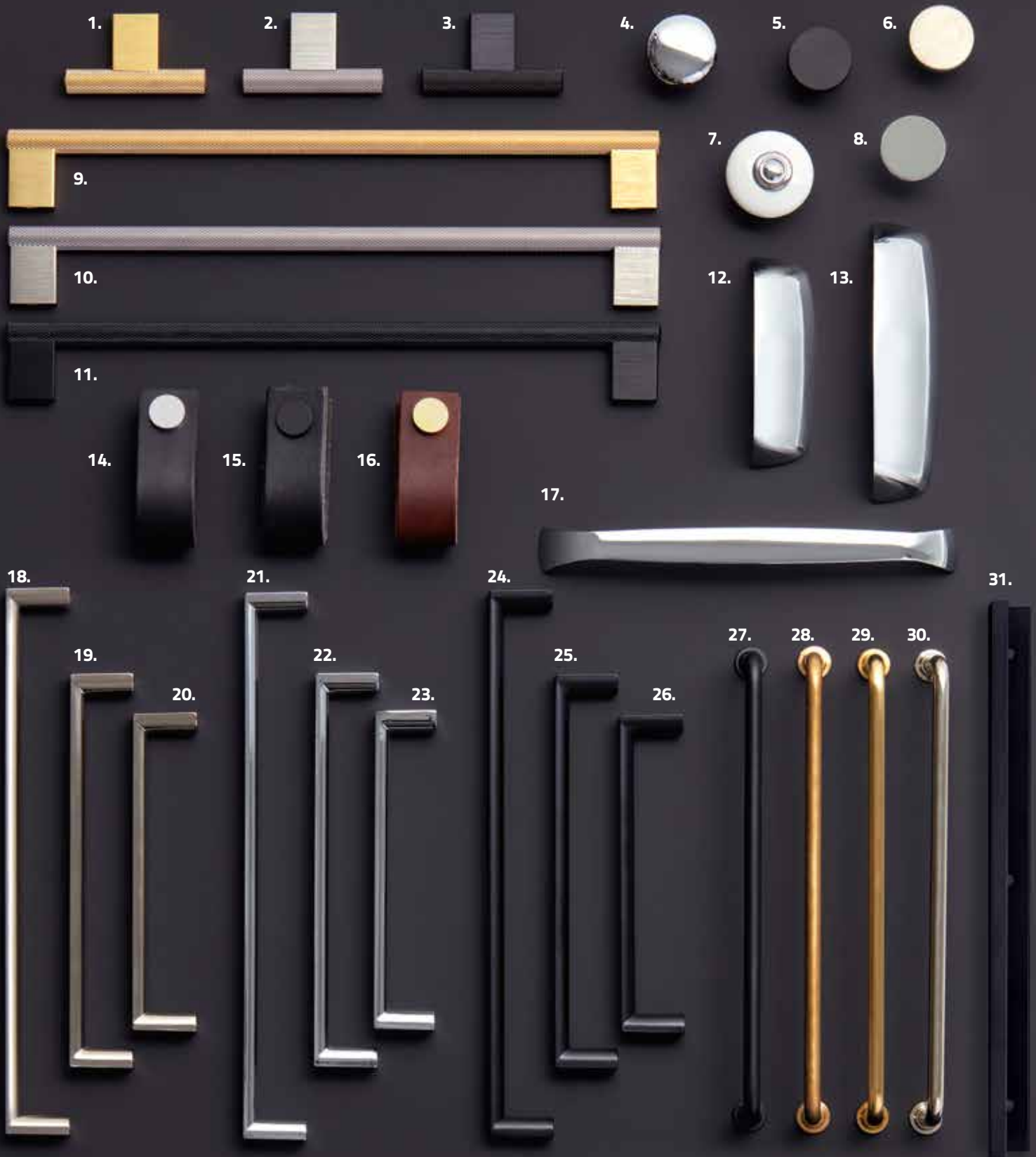

1. Knob	3102MP	Brass	L60, D10 mm	£14
2. Knob	3102BN	Stainless finish	L60, D10 mm	£14
3. Knob	3102B	Matt Black	L60, D10 mm	£14
4. Knob	3103C	Chrome	W30 mm	£10
5. Knob	3101B	Matt Black	Ø28, D25 mm	£10
6. Knob	3101BN	Stainless finish	Ø28, D25 mm	£10
7. Knob	3105C	Chrome/white	Ø36 mm	£15
8. Knob	3101C	Chrome	Ø28, D25 mm	£10
9. Handle	3002-256MP	Brass	c/c 256 mm	£24
10. Handle	3002-256BN	Stainless finish	c/c 256 mm	£24
11. Handle	3002-256B	Matt Black	c/c 256 mm	£24
12. Handle	3003-64C	Chrome	c/c 64 mm	£14
13. Handle	3003-96C	Chrome	c/c 96 mm	£14
14. Handle	3104C	Leather Black/Chrome	25x65 mm	£15
15. Handle	3104B	Leather Black/Black	25x65 mm	£15
16. Handle	3104MP	Leather Brown/Brass	25x65 mm	£15

17. Handle	3004-160C	Chrome	c/c 160 mm	£14
18. Handle	3001-224BN	Stainless finish	c/c 224 mm	£14
19. Handle	3001-160BN	Stainless finish	c/c 160 mm	£14
20. Handle	3001-128BN	Stainless finish	c/c 128 mm	£14
21. Handle	3001-224C	Chrome	c/c 224 mm	£14
22. Handle	3001-160C	Chrome	c/c 160 mm	£14
23. Handle	3001-128C	Chrome	c/c 128 mm	£14
24. Handle	3001-224B	Matt Black	c/c 224 mm	£14
25. Handle	3001-160B	Matt Black	c/c 160 mm	£14
26. Handle	3001-128B	Matt Black	c/c 128 mm	£14
27. Handle	3009-192B	Matt Black	c/c 192 mm	£15
28. Handle	3009-192MP	Untreated Brass	c/c 192 mm	£15
29. Handle	3009-192MP1	Brushed Brass	c/c 192 mm	£15
30. Handle	3009-192C	Chrome	c/c 192 mm	£15
31. Pull Handle	3006-192B	Matt Black	L 232 mm	£14

Miller
FINE BATHROOM INTERIORS



*Your way.
The Miller Way.*



MILLER FROM SWEDEN LTD.
Unit 16, Thame Park Business Centre
Wenman Road. Thame OX9 3XA, England
Tel: +44 (0) 1844 264800
sales@millerbathrooms.co.uk

www.millerbathrooms.co.uk