

Single-loop digital display controller Instructions

1. Introduction

Single-loop digital display controller with automatic SMD packaging technology, has a strong anti-jamming capability. Designed with dual-screen LED display, it could display more contents. It can be used in conjunction with various sensors、transmitters to display temperature, pressure, liquid level, speed, force and other physical parameters, and to output alarm control, analog transmission, RS-485/232 communication etc. More than the traditional digital display meters is a new function to restore the factory default parameters, with easier operation and better applicability.

2. Technical specifications

Input				
Input signals	Current	Voltage	Resistance	Thermocouple
Input Impedance	≤250Ω	≥500KΩ		
Maximum input current	≤30mA			
Maximum input voltage		≤6V		
Output				
Output signals	Current	Voltage	Relay	24V distribution or feeder
Output load capability	≤500Ω	≥250 KΩ (Note: Please replace the module for higher load capacity)	AC220V/0.6 (small) DC24V/0.6A (small) AC220V/3A (big) DC24V/3A (big) According to Remarks	≤30mA
Comprehensive parameter				
Accuracy	0.2%FS±1 bit			
Setting model	Panel touch key parameter setting values locking; store the setting values permanently			
Display style	-1999 ~ 9999 display range 0 ~ 100% measured value lightness bargraph display; LBD display for working state			
Working environment	Ambient temperature: 0 ~ 50 ℃; Relative humidity: ≤ 85% RH; Far from strong corrosive gas			
Power supply	AC 100 ~ 240V, (50/60HZ); DC 20 ~ 29V			
Power	≤5W			
Frame	Standard snap-on			
Communication	Standard MODBUS communication protocol, RS-485, communication distance up to 1 km,			

RS-232 ,communication distance up to 15 meters

Note: While with communication function, the communication converter should be a active one.

Note: The output load capacity of external dimensions D, E, H,instrument relay is the AC220V/0.6A, DC24V/0.6A.

3. Display panel and function keys



1) Instrument dimension and hole size:





Dimensions/code	Hole Size
160*80mm (Horizontal)/A	152*76mm
80*160mm (Vertical)/B	76*152mm
96*96mm (squarely)/C	92*92mm
96*48mm (Horizontal)/D	92*45mm
48*96mm (Vertical)/E	45*92mm
72*72mm (squarely)/F	68*68mm
48*48mm (squarely)/H	45*45mm
160*80mm (Horizontal / beam)/K	152*76mm
80*160mm (Vertical / beam)/L	76*152mm
96*96mm (squarely)/M	92*92mm

2) Digital display

PV display window: show measured values; in parameter setting state, display parameter symbols

SV display window: show input dividing symbol, alarm values etc. as your choice; in the parameter setting state, display setting parameter values

3) Keys

	Enter key: conformation for parameters update Page Down: Page down for parameter settings Exit key: Return to measurement screen pressed for 2 seconds
	Shift key: Shift to the left one bit every press; Return key: Return to a the upper parameters pressed for 2 seconds
	Minus key: used to reduce the value; Display time under print function
	Plus key: increase the value; Display time under print function

4) 4 Indicators

AL1: Alarm 1 indicator

AL2: Alarm 2 indicator

AL3: Alarm 3 indicator

AL4: Alarm 4 indicator

4. Standard Wiring

You should pay attention to the following items when wire the instruments:

PV input (process signal input)

1. To reduce electrical interference, the low-voltage DC signal and sensor input wire should stay away from strong electrical wire. If not, you should use shielded wire, and ground it at one point.

2. Any device between the sensor and terminal, maybe affects the measurement accuracy due to resistance or leakage current

Thermocouple or pyrometer input

You should use the compensation wires corresponding for the thermocouple as extension wire, and it's the best if the wire is shielding.

RTD (platinum resistance) input

The resistance for the 3 wire must be the same, and each wire must not exceed 15Ω resistor.

5. Powering settings

As soon as instrumentation is powered on, it enters into the self-testing status (seen in the right), and when self- testing is completed, it automatically transfers to the working state.



In the working state, press the button  and it displays LOC, LOC parameter settings are listed in the following:

1.1) You can enter into Level 1 menu whatever the Loc is (LOC = 00、132, no locking function);



2) when Loc is 132, press button  for 4 seconds to enter Level 2 menu;

3) when Loc is 130, press button  for 4 seconds to enter the time setting menu, only for the instruments with printing capability.

4) when Loc is others, press the button  for 4 seconds to return to the measuring state.





2. If Loc is 577, in the Loc menu, press the key  and  for 4 seconds at the same time, you can restore all the parameters to factory default settings.

3. In any other menu, press the button  for 4 seconds to exit to the measuring screen.

4. In measurement screen, press the key  and  for 4 seconds at the same time, you can

modify the alarm values in Level I.

5. When thermocouple signal as input and channel decimal dP is 0, the temperature resolution is 1 °C; when dP is 1, the temperature resolution is 0.1 °C, (resolution automatically changed to 1 °C when the temperature is over 1000 °C).

6. Time setting. In the state of PV displaying measured values, press the button  to enter parameters setting, set LOC as 130; In the state of PV displaying LOC and SV displaying 130, press button  for 4 seconds to enter into the time parameter settings. When PV displays "dATE " and SV displays the current date (for example :090720-July 20, 2009) set the current date in the same way as parameters settings. In the state of current time, press the key , PV displays "TInE" and SV displays the current time (for example, 183047-18:30:47), set the current time in the same way as parameters settings. In the state of current time, press the button  again to exit time setting to PV measuring screen.

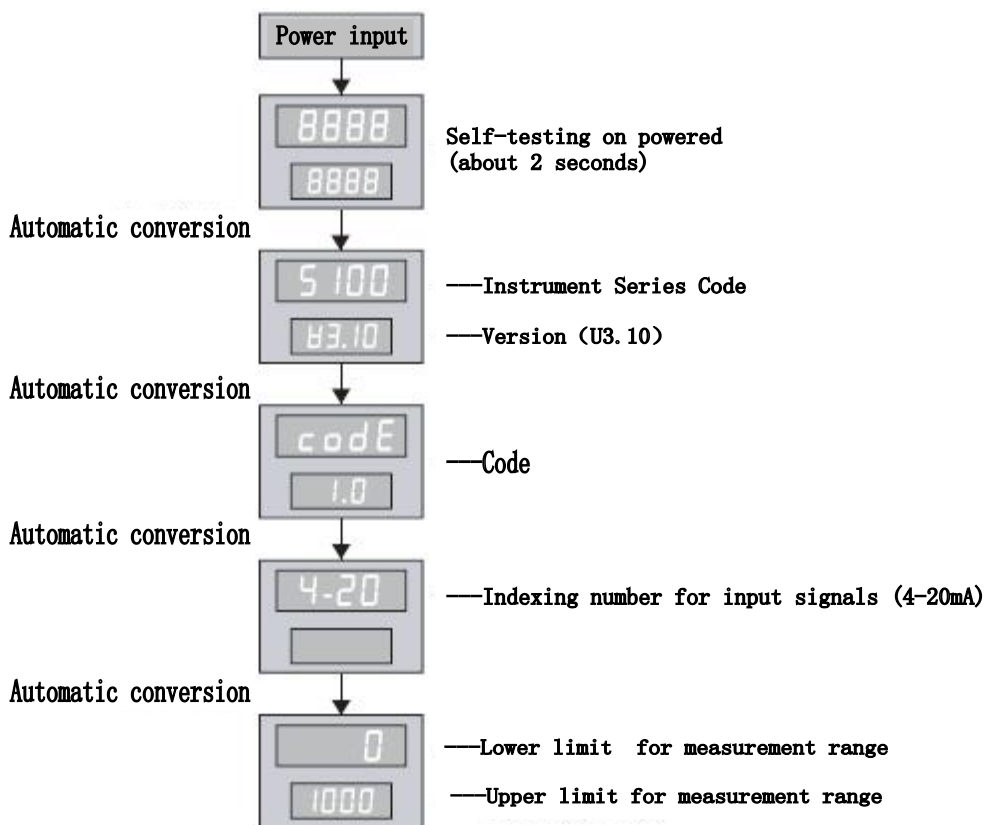

★ Back to working status



1. Manual way: In the state of parameters setting, press the button  for 4 seconds, the instrument will automatically return to real-time measurement state.











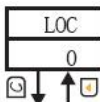





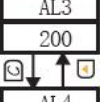

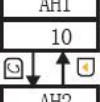

2 Auto way: In the state of parameters setting, do not press any button. After 30 seconds the instrument will automatically return to real-time measurement state.

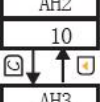
6.Parameters settings

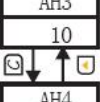
6.1 Level 1 parameters setting

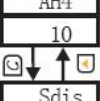
In working state, press button  and PV displays LOC, SV displays the parameter values:

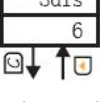





Press  or  to set parameters. Press button  for 2 seconds to return to upper lever parameter, when Loc is any value. You can enter into Level 1 parameter setting



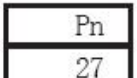
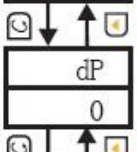

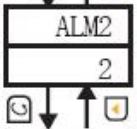
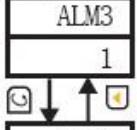
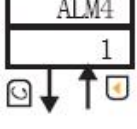
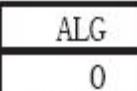

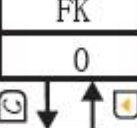
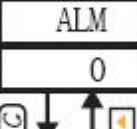

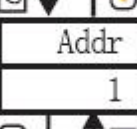
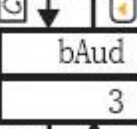



Default setting	Parameters	Setting range	Description
                    Back to the original screen LOC	Loc Parameters locking	0~999	LOC=00: No locking (Level 1 parameters can be modified) LOC#00、132: Locking(Level 1 parameters can not be modified) LOC=132: No locking (Level 1 and Level 2 parameters can be modified)
	AL1 Value for arm 1 setting	-1999~9999	Value for arm 1 setting
	AL2 Value for arm 2 setting	-1999~9999	Value for arm 2 setting
	AL3 Value for arm 3 setting	-1999~9999	Value for arm 3 setting
	AL4 Value for arm 4 setting	-1999~9999	Value for arm 4 setting
	AH1 Value for arm 1 difference	0~9999	Value for arm 1 difference
	AH2 Value for arm 2 difference	0~9999	Value for arm 2 difference
	AH3 Value for arm 3 difference	0~9999	Value for arm 3 difference
	AH4 Value for arm 4 difference	0~9999	Value for arm 4 difference
	Sdis SV content of the display	0~7	Sdis=0: Displaying indexing number values Sdis=1: Displaying Arm 1 values Sdis=2: Displaying Arm 2 values Sdis=3: Displaying Arm 3 values Sdis=4: Displaying Arm 4 values Sdis=5: Displaying time Sdis=6: Displaying temperature ℃ Sdis=7: Displaying nothing

6.2 Level 2 parameter settings

In the working state, press button  and PV displays LOC, SV displays parameter values;

Press  or  to set parameters. Press the button  for 2 seconds to back to the upper parameters setting; when Loc is 132, press button  for 4 seconds, you can enter into Level 2 parameters setting.

Default setting	Parameters	Setting rang(word)	Description
	<i>P_n</i> Indexing number	0~35	Set the input index number types (see dividing type table)
	<i>dP</i> Decimal	0~3	dP=0: No decimal point dP=1: Decimal point in the ten (Displaying XXX.X) dP=2: Decimal point in the hundred (Displaying XX.XX) dP=3:Decimal point in the thousand (Displaying X.XXX)
	<i>ALM1</i> Alarm 1	0~2	ALM1=0: No alarm ALM1=1:Alarm 1 as lower limit alarm ALM1=2: Alarm 1 as upper limit alarm
	<i>ALM2</i> Alarm 2	0~2	ALM2=0: No alarm ALM2=1: Alarm 2 as lower limit alarm ALM2=2: Alarm 2 as upper limit alarm
	<i>ALM3</i> Alarm 3	0~2	ALM3=0: No alarm ALM3=1: Alarm 3 as lower limit alarm ALM3=2: Alarm 3 as upper limit alarm
	<i>ALM4</i> Alarm 4	0~3	ALM4=0: No alarm ALM4=1: Alarm 4 as lower limit alarm ALM4=2: Alarm 4 as upper limit alarm ALM4=3: alarm as off-line (when input signal is disconnected the alarm 1 -3 function is invalid)
	<i>ALG</i> flicker alarm	0~1	ALG = 0: flicker alarm function invalid ALG = 1: flicker alarm function valid
	<i>FE</i> Filter coefficients	0~19 times	Setting filter coefficients to prevent value flicking(seen in instrument parameters description 2)
	<i>ALM</i> Alarm function	0~19	one = 0: No alarm delay function one = 1-9: delay (0.5 × value set) seconds and then output alarm signals ten = 0: Alarm when off-line(relay contact alarm output) ten = 1: No alarm when off-line (Note: When ALM4 is 3, this function is invalid)
	<i>brK</i> Display value when off-line	0~3	Brk = 0: Displaying 0 when off-line Brk = 1: Displaying maximum indexing number value when off-line Brk = 2: Displaying maximum value before when off-line Brk = 3: Displaying then value before off-line
	<i>Addr</i> Device ID	0~250	The ID for the device when setting communications parameters
	<i>bAud</i> Communication baud rate	0~3	Baud = 0: Communication baud is 1200bps; Baud = 1: Communication baud is 2400bps Baud = 2: Communication baud is 4800bps; Baud = 3: Communication baud is 9600bps
	<i>Pr-A</i> Alarm printing	0~1	Pr-A = 0: no alarm printing function (no this parameter if no this function) Pr-A = 1: With alarm printing function (no this parameter if no this function)

Default setting	Parameters	Setting rang(bit)	Description
 Pr-t 0	Pr-t Print interval time	1~2400 Minutes	Set print interval time (The function is invalid when less than 10 minutes) (No this parameter if no this function)
 Pr-u 0	Pr-u Print unit	0~45	Seen in the unit setting code table (No this parameter if no this function)
 Pb 0	Pb Displaying input zero shift	Full range	Set the displayed zero shift range (seen in instrument parameters Description 3)
 Pk 1.000	Pk Displaying the proportion of the input range	0~1.999 Times	Set the proportion of input range (seen in the instrument parameters Description 3)
 Cb 0	Cb zero shift of cold-junction compensation	Full range	Set the zero shift range of cold-junction compensation (only for thermocouple signals)
 CK 1.000	CK Amplification of cold-junction compensation	0~1.999 Times	Set amplification of cold-junction compensation (only for thermocouple signals)
 1oub 0.000	1oub Zero shift of transmission output 1	0~1.2	Setting the zero shift range of transmission output 1 (seen in the instrument parameters Description 4)
 1ouk 1.000	1ouk Amplification of transmission output 1	0~1.2	Set amplification of transmission output 1 (seen in the instrument parameters Description 4)
 2oub 0.000	2oub Zero shift of transmission output 2	0~1.2	Setting the zero shift range of transmission output 2 (seen in the instrument parameters Description 4)
 2ouk 1.000	2ouk Amplification of transmission output 2	0~1.2	Set amplification of transmission output 2 (seen in the instrument parameters Description 4)
 ouL 0	ouL lower limit of transmission output range	Full range	Set the lower limit of the transmission output range
 ouH 1000	ouH upper limit of transmission output range	Full range	Set the upper limit of the transmission output range
 GL 0	GL Lower limit of flicker alarm	Full range	Set the lower limit of flicker alarm range (when measured value is lower than set value, the measured value flickers ; this function exists when ALG=1)

Default setting	Parameters	Setting rang(bit)	Description
	GH Upper limit of flicker alarm	Full range	Set the upper limit of flicker alarm range(when measured value is higher than set value, the measured value flickers ; this function exists when ALG=1)
	ZL Lower limit of Bargraph	Full range	Set the lower limit of bargraph (only for bargraph) (Seen in Instrument Parameter Description 5)
	ZH Upper limit of Bargraph	Full range	Set the upper limit of bargraph (only for bargraph) (Seen in Instrument Parameter Description 5)
	PL lower limit Lower limit of Measurement range	Full range	Set the lower limit of measured values
	PH upper limit Lower limit of Measurement range	Full range	Set the upper limit of measured values
	Cut Small input signal excision	Full range	Set small input signal excision range (when input signal is lower than value set, it displays 0. This function only for voltage or current signals)

★Input signal types table:

Degree no .Pn	Signal types	measuring range	Degree no Pn	Signal types	measuring range
0	Thermocouple B	400~1800℃	18	Remote Resistance 0~350Ω	-1999~9999
1	Thermocouple S	0~1600℃	19	Remote Resistance 3 0~350Ω	-1999~9999
2	Thermocouple K	0~1300℃	20	0~20mV	-1999~9999
3	Thermocouple E	0~1000℃	21	0~40mV	-1999~9999
4	Thermocouple T	-200.0~400.0℃	22	0~100mV	-1999~9999
5	Thermocouple J	0~1200℃	23	-20~20mV	-1999~9999
6	Thermocouple R	0~1600℃	24	-100~100mV	-1999~9999
7	Thermocouple N	0~1300℃	25	0~20mA	-1999~9999
8	F2	700~2000℃	26	0~10mA	-1999~9999
9	Thermocouple Wre3-25	0~2300℃	27	4~20mA	-1999~9999
10	Thermocouple Wre5-26	0~2300℃	28	0~5V	-1999~9999
11	RTD Cu50	-50.0~150.0℃	29	1~5V	-1999~9999
12	RTD Cu53	-50.0~150.0℃	30	-5~5V	-1999~9999
13	RTD Cu100	-50.0~150.0℃	31	0~10V	-1999~9999
14	RTD Pt100	-200.0~650.0℃	32	0~10mA square	-1999~9999
15	RTD BA1	-200.0~600.0℃	33	4~20mA square	-1999~9999
16	RTD BA2	-200.0~600.0℃	34	0~5V square	-1999~9999
17	Linear resistance 0~400Ω	-1999~9999	35	1~5V square	-1999~9999

★Unit Setting Function Code Table:

Code	0	1	2	3	4	5	6	7	8	9
------	---	---	---	---	---	---	---	---	---	---

Unit	kgf	Pa	KPa	MPa	mmHg	mmH ₂ O	bar	°C	%	Hz
Code	10	11	12	13	14	15	16	17	18	19
Unit	m	t	l	m ³	kg	J	MJ	GJ	Nm ³	m/h
Code	20	21	22	23	24	25	26	27	28	29
Unit	t/h	l/h	m ³ /h	Kg/h	J/h	MJ/h	GJ/h	Nm ³ /h	m/m	t/m
Code	30	31	32	33	34	35	36	37	38	39
Unit	l/m	m ³ /m	Kg/m	J/m	MJ/M	GJ/m	Nm ³ /m	m/s	t/s	l/s
Code	40	41	42	43	44	45				
Unit	m ³ /s	Kg/s	J/s	MJ/s	GJ/s	Nm ³ /s				

7. The parameter description

1. Alarm output (AL1, AL2, AH1, AH2)

★ About difference:

This instrument uses alarm output with difference in order to prevent the frequent action when output relay or alarm output value is near the setting point.

Specific output state is as follows:

★ measured values arise:

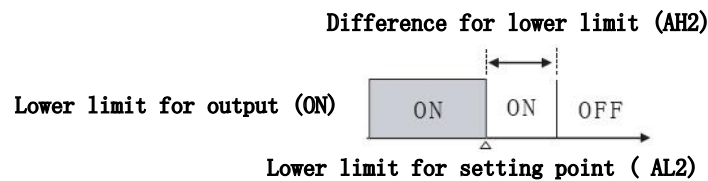

★ measured values decreases:

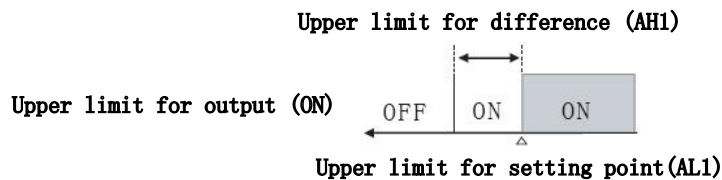

★ Upper limit of position alarm output:

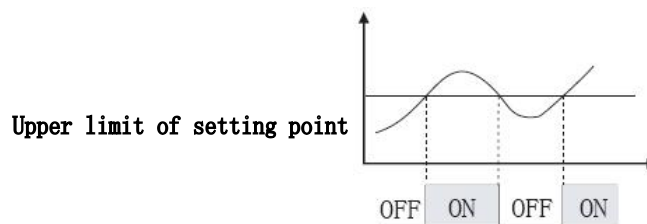

★ Lower limit of position alarm output:

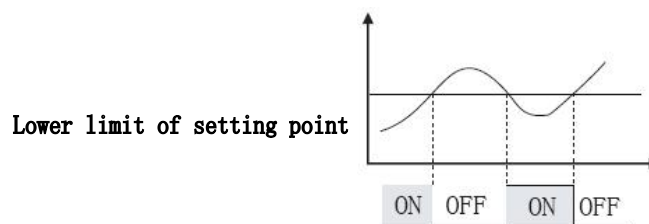

2. Filter coefficient

the times of sampling, used to prevent the flicking of measured values;

Sampling period – analog signals as input, the interval of each data acquisition is 0.5 seconds. The relation of PV displaying value, filter coefficient and sampling period is listed as followed:

Example: Analog signals as input, supposing the filter coefficient equals 6 (time), then the instrument will automatically average the input signals during(6 × 0.5) 3 seconds, and refresh PV display value. (Namely displaying the average value of the input signals during front 3 seconds)

3. Display shift and amplification of input signals:

In regular modification, you can adjust the value of Pb and Pk to change the display error of measured value.

The formula of Pb and Pk:

$Pk = \frac{\text{the setting display range}}{\text{real display range}} \times \text{original Pk}$

$Pb = \text{the lower limit of setting display range} - \text{the lower limit of real display range} \times Pk + \text{original Pb}$

Example: 4 ~ 20mA DC current as input signal, measured range = 200 ~ 1000 KPa, and then we make regular modification and find that when input is 4 mA, it displays -202; when input is 20 mA, it displays 1008. (Original Pb = 0, original Pk = 1.000)

According to the formula :

$Pk = \frac{\text{setting display range}}{\text{real display range}} \times \text{original Pk}$

$$= \frac{[1000 - (-200)]}{(1008 - (-202))} \times 1 = 1200 \div 1210 \times 1 \approx 0.992$$

$Pb = \text{the lower limit of setting display range} - \text{the lower limit of real display range} \times Pk + \text{original Pb}$

$$= -200 - (-202 \times 0.992) + 0 = 0.384$$

Supposing: Pb = 0.384, Pk = 0.992

4. Zero shift of transmission output 10ub, 10uK, 20ub, 20uK

Please base 0 ~ 20mA or 0 ~ 5V to make modification to this instrument. If you want make a change to output range or output error, you can refer to the following formula:

$$\text{New Oub} = \text{Current Oub} - \frac{\text{Current output lower limit} - \text{Set output lower limit}}{\text{Full scale}}$$

$$\text{New OuK} = \text{Current OuK} - \frac{\text{Current output Upper limit} - \text{Set output Upper limit}}{\text{Full scale}}$$

In this formula, when the output is current signal, full scale = 20mA; when the output is voltage

signal, full scale = 5V.

Example 1: Transmission current 0 ~ 20mA as output, and we want to change it to 4 ~ 20mA. We measure that when output zero is 0 mA, if the input is full scale, that output is 20 mA. Current $O_{ub} = 0$, and current $O_{uK} = 1$.

$$\text{New } O_{ub} = 0 - \frac{0-4}{20} = 0.2 \quad \text{New } O_{uK} = 1 - \frac{20-20}{20} = 1$$

Therefore, set O_{ub} as 0,2, and keep O_{uK} unchanged, we have changed the output from 0 ~ 20mA to 4 ~ 20mA.

5. Bargraph display:

Bargraph display: If measurement range is 0 ~ 100 and the current measured value is 50, then the light beam lights from 0 to 50.

Bargraph display range: bargraph display range is the percentage ZL, ZH.

For example:

- 1) Set the range as 0 ~ 100, if the current measured value is 50, then the light beam displays 50%.
- 2) Set the range as 0 ~ 1000, if the current measured value is 500, then the light beam displays 50%.
- 3) Set the range as 0 ~ 2000, if the current measured value is 1000, then the light beam displays 50%.

8. wiring diagram

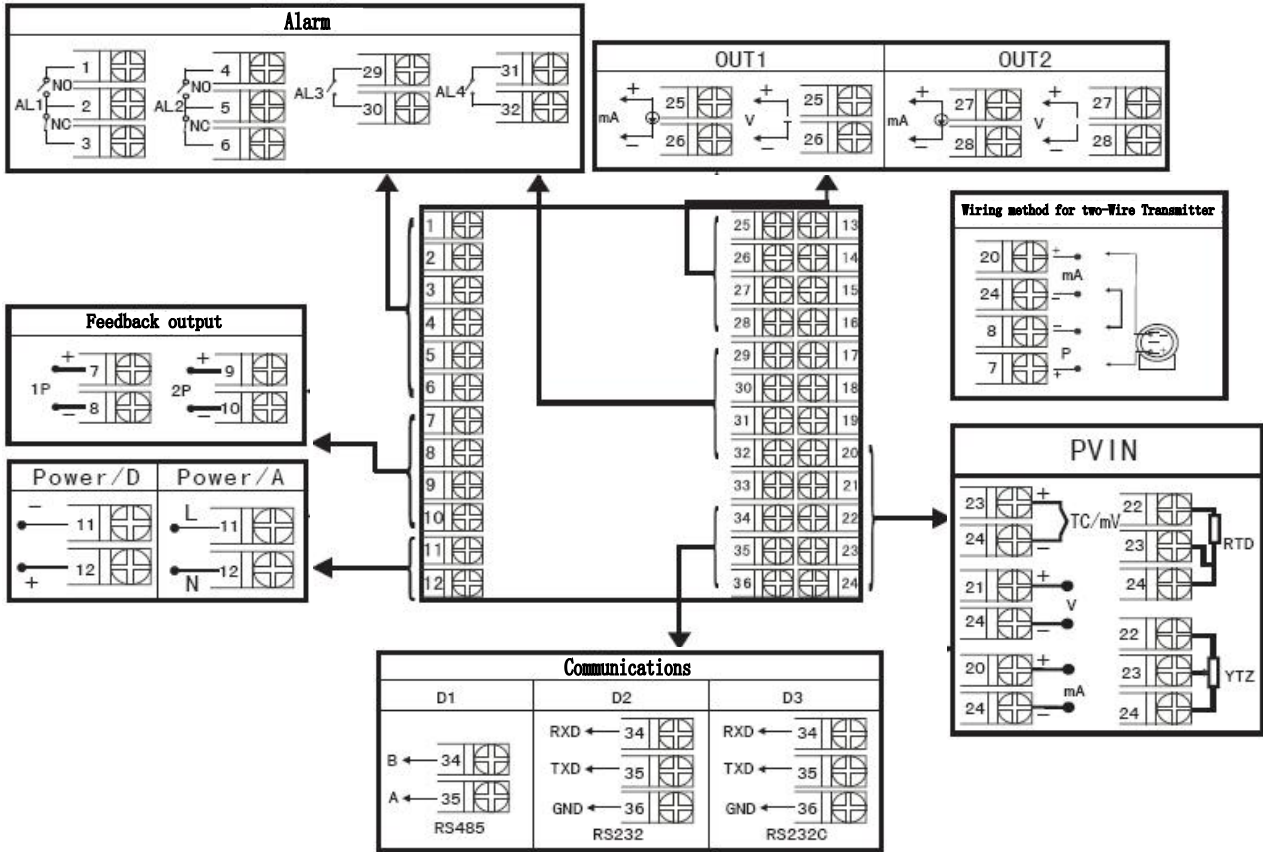

Wiring diagram of A, B, C, D, E, K, L, M-type

Note: The horizon and vertical device cover terminal block wirings are different, seen in diagram 1.

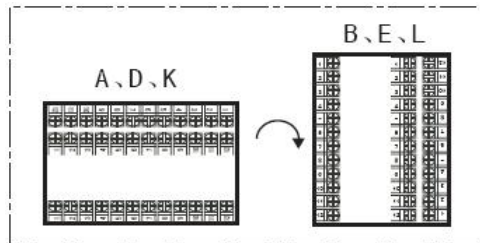

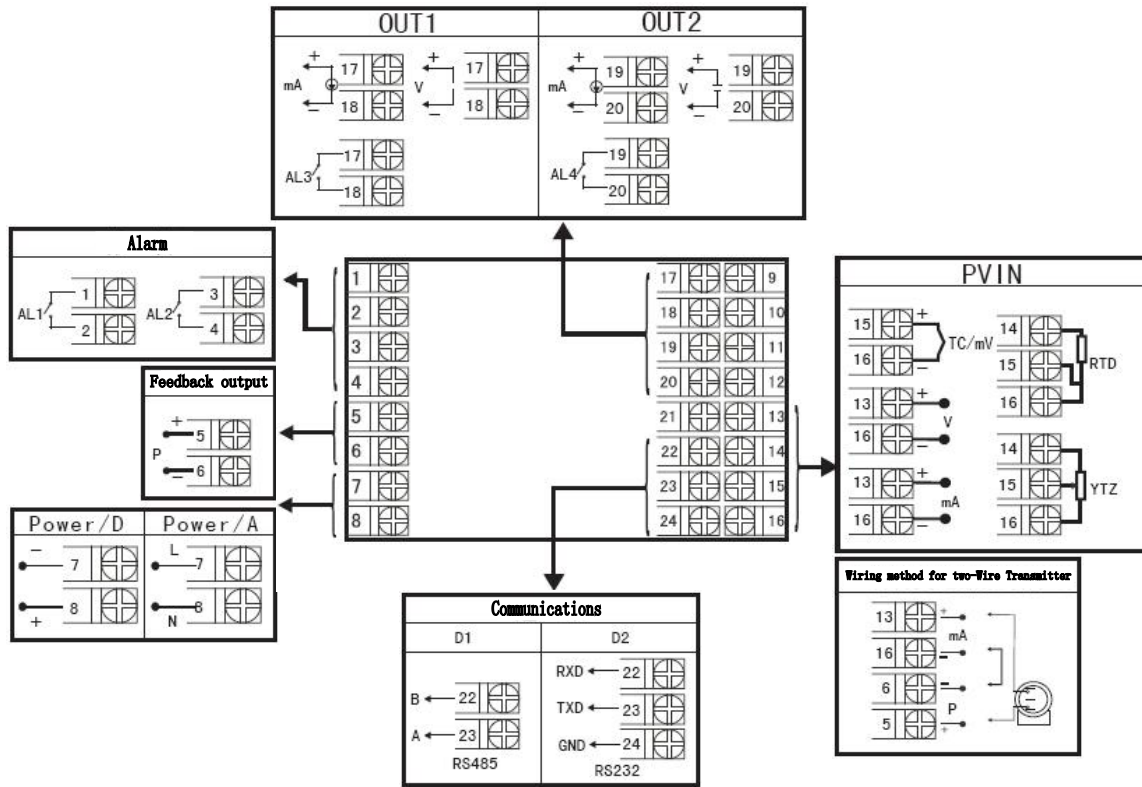

Wiring diagram for F-type

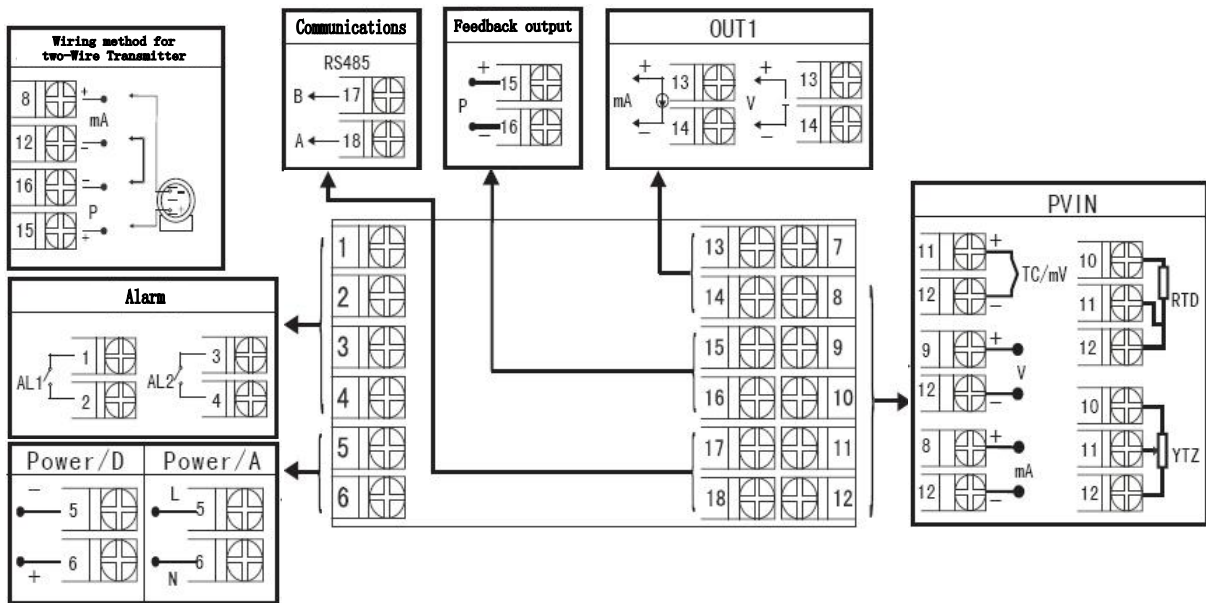

Wiring diagram for H-type

Note: Voltage and current signals of Type F must be switched through the short circuit ring.

J1, J2 for Loop 1 input signal switch positions.

J3, J4 for Loop 2 input signal switch positions





	DC voltage input	DC Current Input
Short-circuit-ring	 V mA	 V mA

Diagram for Type F:

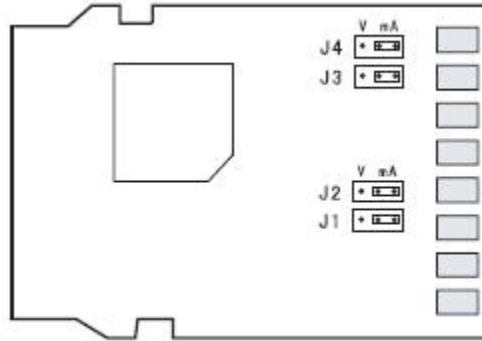

9. Print function

1. Manual print

In the state of measuring screen, press the button  to print the current real-time measured values.

2. Regular print

Every interval time, the instrument will control the printer to print the current real-time measured values. Printing format as followed:

```

-----
TIME PRINT
2009-05-16      -----Date
09: 46: 03     -----Time
PV=-250°C      ----- Measured values
ALM: ○○○●     ----- Alarm Status
-----
    
```

3. wiring

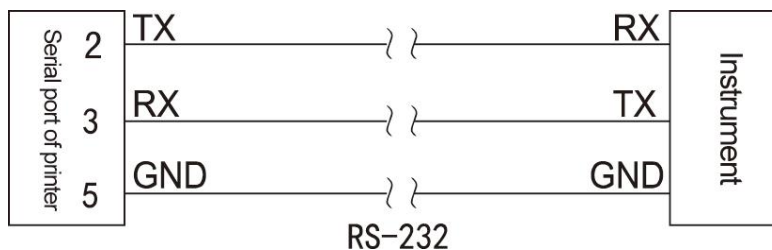

• 10.Communication

This instrument has the ability to communicate with upper computer, and the upper computer can complete the automatic adjustment, parameters setting, data collection and watch of the lower instruments. With the corresponding software, you can finish dynamic picture displaying, parameters

setting, diagram printing, logging and report printing and so on in Windows. You can communicate with RS-485, RS-232 in 1200~9600 bps. The data format is: one starting bit, eight data bits and one stopping bit.

★ Specific parameters seen in the "Instrument Communication Handbook".

This instrument can be used with a variety of equipment with serial input and output.