



All Weather Furnishings

Model:

PL81-T2L1

- (1) Table top
- (2) Leg Assemblies
- (2) Brace
- (1) Hardware pack

TOOLS NEEDED

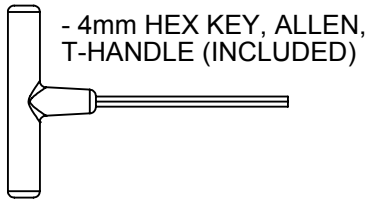

- 3/8" Wrench (not included)

Step 1

Attach leg assemblies to table top using and (8) 2-1/2" chair bolts.

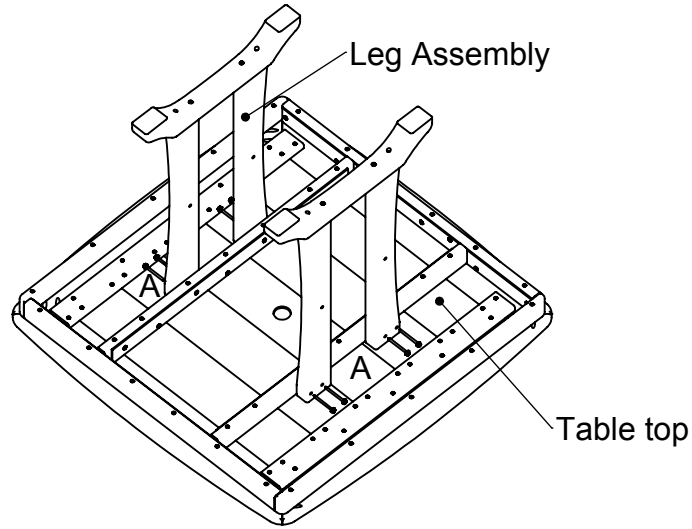

Step 2

Attach braces to leg assemblies using (4) 3" screws.

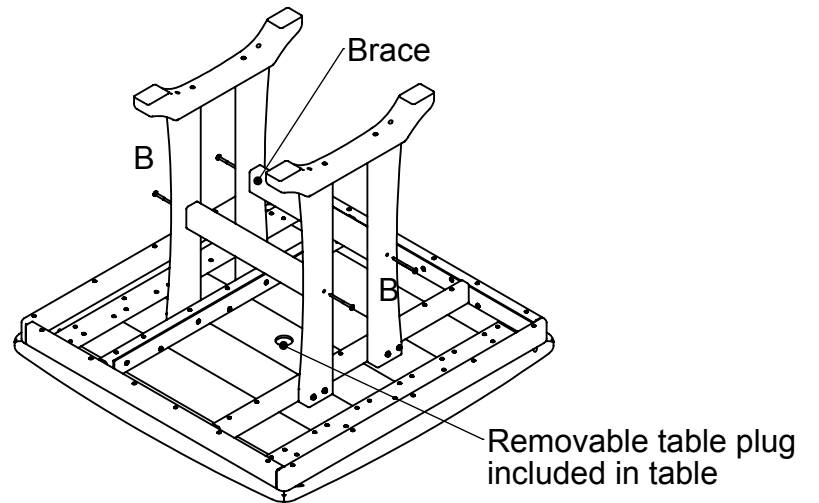

Qty.	Description
------	-------------

8	A - 14 X 2.50 HEX WASHER T-A ALCHM
---	------------------------------------



4	B - .273 X 3 SOCKET WAFER A
---	-----------------------------



POLYWOOD®

All Weather Furnishings

Join the POLYWOOD® Community

Share in the love of outdoor living, recycling, and more...



POLYWOOD



@POLYWOODINC



youtube.com/polywood



POLY-WORLD
Blog



POLYWOOD



To view our full warranty, please visit the warranty page on our website at polywoodinc.com/resources.

If you have questions or concerns regarding assembly instructions or missing parts, please contact us at (877) 457-3284 or email support@polywoodinc.com