

Assembly Directions for 44"x72" Rectangular Table

in Garden Classic Collection

#GCIT4472D, #GCIT4472C, #GCIT4472B

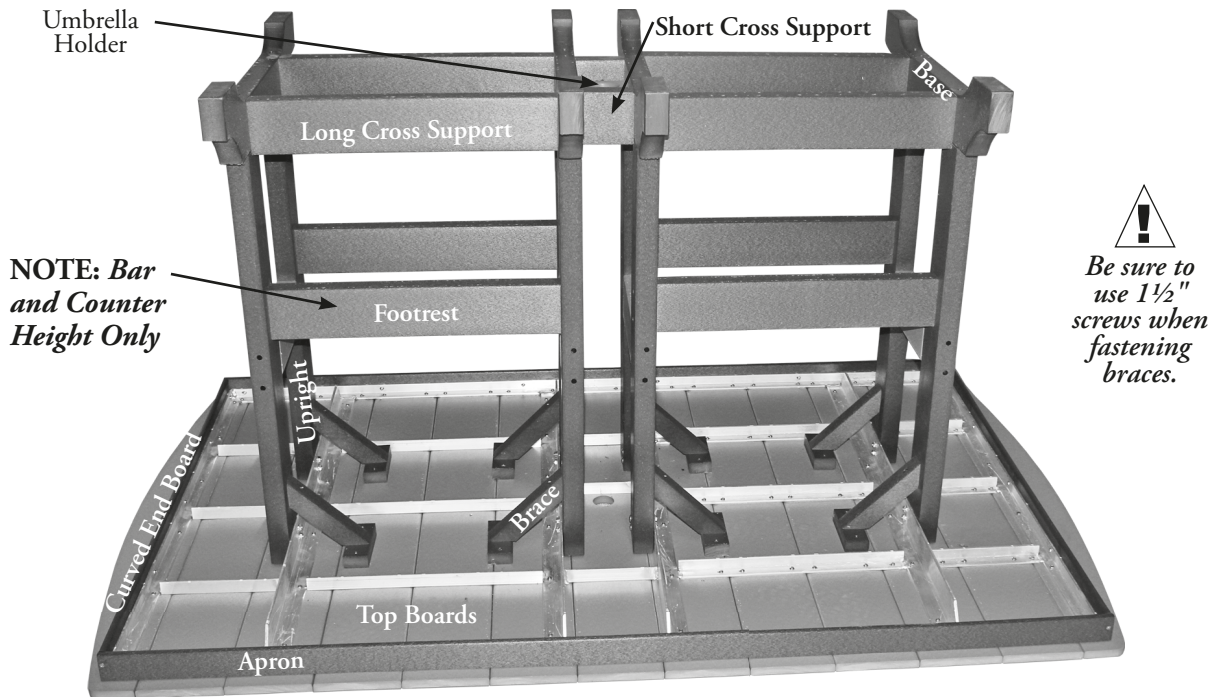

Garden Classic Table

PACKAGE CONTENTS

- 1 Top
- 4 Bases
- 4 Long Cross Supports
- 2 Short Cross Supports
- 4 Footrests (Bar and Counter Height)
- 1 Umbrella Holder
- 1 Umbrella Plug
- 8 Braces
- 1 Hardware Package

HARDWARE PACKAGE

- 16 1/4" x 2" Allen Head Bolts
- 16 1/4" Flange Nuts
- 2 Umbrella Knobs
- 44 3" Screws
- 8 1 1/2" Screws
- 16 5/8" Pan Head Screws
- 1 Allen Wrench

TOOLS NEEDED:

- Hammer
- 7/16" Wrench
- Cordless Drill/Screwdriver
- Allen Wrench (Included)

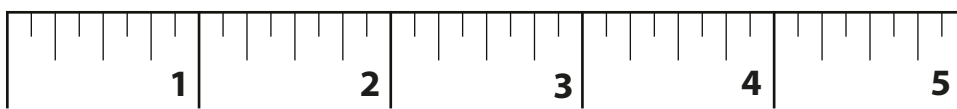

Use to measure bolts



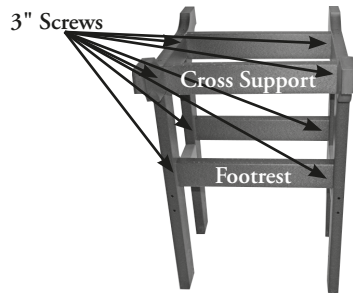

STEP #1 - First assemble both Bases and Long Cross Supports using 3" Screws.
Please note: There are two outside Bases and two center Bases. The two center Bases have extra mortises for the Umbrella Holder and Short Cross Supports (see Step #3).

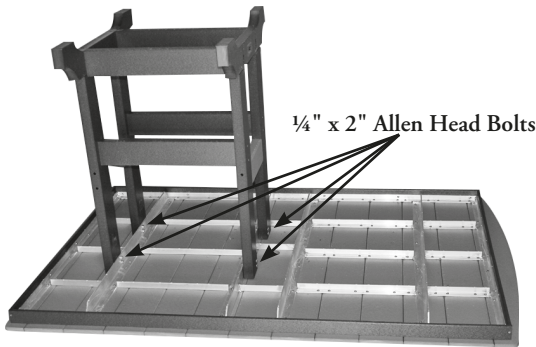

STEP #2 - Attach the first Base Assembly to the aluminum frame of the Top using 8- 1/4" x 2" Allen Head Bolts.

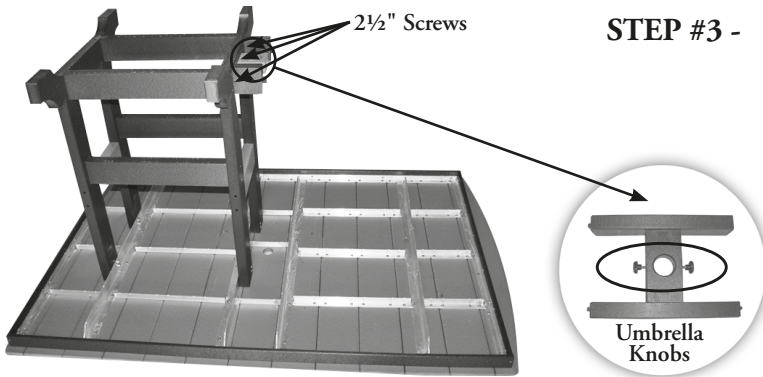

STEP #3 - Attach the two Short Cross Supports and the Umbrella Holder to the Base using 2 1/2" Screws.

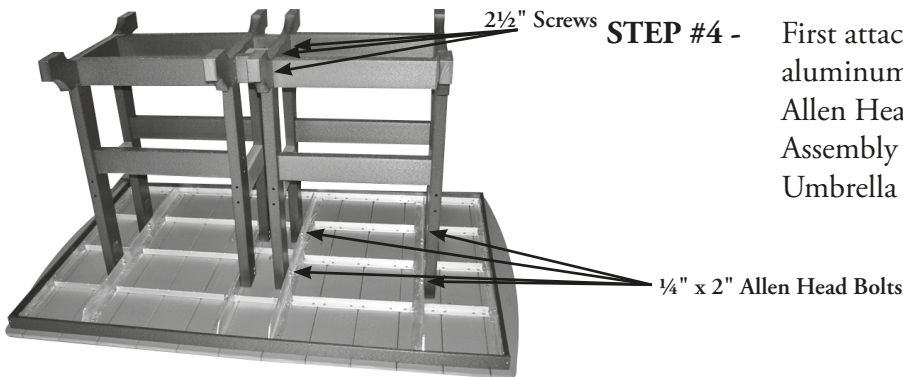
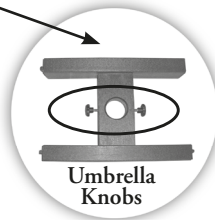

STEP #4 - First attach the second Base Assembly to the aluminum Frame of the Top using 8- 1/4" x 2" Allen Head Bolts. Second fasten the Base Assembly to the Short Cross Pieces and Umbrella Holder using 2 1/2" Screws.

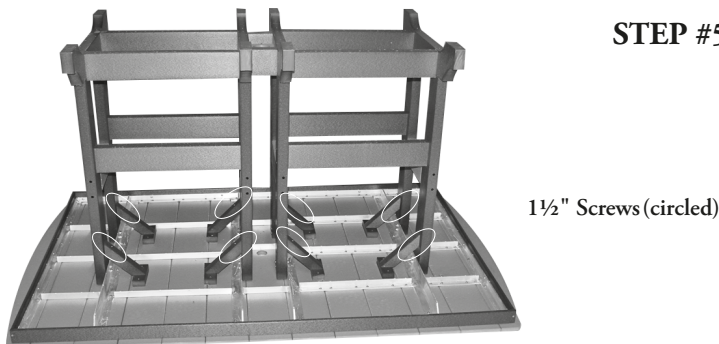

STEP #5 - Last, attach the Braces to the Top and the Base using 1 1/2" Screws and 5/8" Pan Head Screws (these go into the top).