



GAZZDA

---

# Fina storage

Product sheet

design by  
**Mustafa Čohadžić**



reddot award 2018  
winner



**BIGSEE  
WOODDESIGN  
AWARDWINNER  
2018**



# Fina storage units

## Product facts

### Materials

---

Body	Solid oak
Finish	Hardwax oil
Fronts	Furniture linoleum
Legs	Powder-coated steel

### Technical features

---

#### Structural frame

Storage unit's body, as well as all inside shelves and drawer boxes, are made of solid wood - oak, except storage unit back panel and drawer bottom panels which are made of high-density fiberboard.

#### Finish

Available in two plant-based Hardwax oil finishes (colours), which retain the wood's natural state, as a white or natural oil.

#### Fronts

Storage unit front panels are made out of linoleum (natural, warm to the touch, smooth, antibacterial surface material) glued on chipboard, framed with solid wood edges, and veneered from the inside. Desktop linoleum is available in two colours.

#### Legs

Steel legs are powder-coated in line with the chosen linoleum colour: Black RAL 9005 for Nero linoleum and Mushroom RAL 1013 for Mushroom linoleum. Legs have a wooden glider cap on their ends.

#### Cleaning

Please see [Product](#) or [Material](#) page on our website.

### Notes to consider

---

#### Variations

Natural variations in wood color and surface may occur. Regular maintenance will ensure the wood preserves its authentic beauty and can last for generations.

#### Product changes

Please note that Gazzda reserves the right to alter construction and design without notice.

#### Dimensions (tolerances)

The dimensions shown are indicative, they may vary due to the natural properties of wood, season, or manufacturing processes. Deviations from the specified size may occur, usually no more than 1 cm.

For all additional inquiries regarding Fina storage units please feel free to [contact us](#).

### Reference - Internal storage symbols

---

**Space** C - Compartment  
D - Drawer  
S - Shelf  
CH - Cable hole

**Position** U - Upper  
M - Middle  
B - Bottom  
R - Right  
L - Left

**Shape** RC - Rectangular  
CR - Circular

e.g. C-UR | Compartment - upper right  
D-BL | Drawer - bottom left  
CH-RC | Cable hole - rectangular

**Shelves** Shelves indicated with triangle arrows are height-adjustable and removable.

# Fina Lowboard 160

Body Solid oak, Fronts Linoleum, Legs Powder-coated steel

Version: 1-1-2023

## Basic info

**Design** Mustafa Čohadžić

**Product size** W: 160, D: 45, H: 48

**Packaging** W: 163, D: 54, H: 34

**Volume** 0,30 m<sup>3</sup>

**Net weight** 47,4 kg

**Gross weight** 50,4 kg

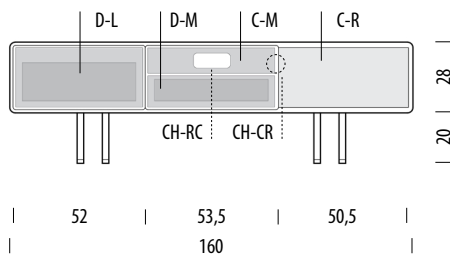

### Item no. 19D

Assembly 15 min / 2 persons

Internal storage	Width	Depth	Height
D-L	45	34,5	15
D-M	43	34,5	8
C-M	51	41	9
C-R	51	41	23,5
CH-RC	14		5
CH-CR	Ø5		

# Fina Lowboard 200

Body Solid oak, Fronts Linoleum, Legs Powder-coated steel

Version: 1-1-2023

## Basic info

**Design** Mustafa Čohadžić

**Product size** W: 200, D: 45, H: 48

**Packaging** W: 202, D: 54, H: 34

**Volume** 0,37 m<sup>3</sup>

**Net weight** 53,8 kg

**Gross weight** 57,3 kg

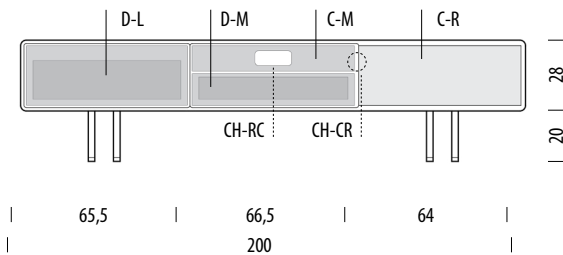

### Item no. 066

Assembly 15 min / 2 persons

Internal storage	Width	Depth	Height
D-L	58	34,5	15
D-M	58	34,5	8
C-M	64	41	9
C-R	64	41	23,5
CH-RC	14		5
CH-CR	Ø5		

## Selected options

### Body

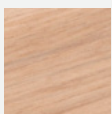

Oiled Oak  
1015  
White oil

### Front panels



Linoleum  
4023  
Nero

Indicated materials and colours are selected by Gazzda as best-selling items and their lead time is shorter than of made-to-order options. Please consult the current price list or our customer service for the lead time of selected options.

For other material options, please see the Available materials section at the end of the product sheet.

# Fina Sideboard 150

Body Solid oak, Fronts Linoleum, Legs Powder-coated steel



Version: 1-1-2023

## Basic info

**Design** Mustafa Čohadžić

**Product size** W: 150, D: 45, H: 64

**Packaging** W: 153, D: 54, H: 50

**Volume** 0,41 m<sup>3</sup>

**Net weight** 48,5 kg

**Gross weight** 52,5 kg

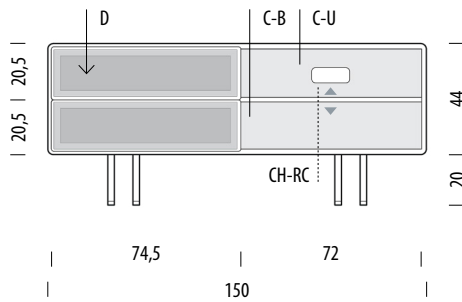

### Item no. 19C

Assembly 15 min / 2 persons

Internal storage	Width	Depth	Height
D	68	34,5	12
C-U	72	40	19/22,5
C-B	72	40	15/18,5
CH-RC	14		5

- ▲ Shelves indicated with triangle arrows are height-adjustable and removable.

# Fina Sideboard 180

Body Solid oak, Fronts Linoleum, Legs Powder-coated steel



Version: 1-1-2023

## Basic info

**Design** Mustafa Čohadžić

**Product size** W: 180, D: 45, H: 64

**Packaging** W: 183, D: 54, H: 50

**Volume** 0,49 m<sup>3</sup>

**Net weight** 58,3 kg

**Gross weight** 62,3 kg

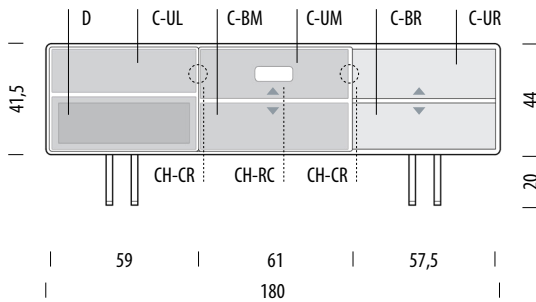

**Pull-out shelf**  
(between C-UL and D)

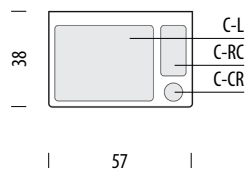

### Item no. 065

Assembly 15 min / 2 persons

Internal storage	Width	Depth	Height
C-UL	57,5	41	19
D	53	34,5	15
C-UM	57,5	41	18/21,5
C-BM	57,5	41	16/19,5
C-UR	57,5	41	18/21,5
C-BR	57,5	41	16/19,5
CH-RC	14		5
CH-CR	Ø5		

### Pull-out shelf

Internal storage	Width	Depth	Height
C-L (15" notebook size)	39	30	1
C-RC	10	20	1
C-CR	Ø7		1

▲ Shelves indicated with triangle arrows are height-adjustable and removable.

## Selected options

Body

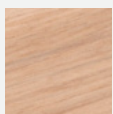

Oiled Oak  
1015  
White oil

Front panels

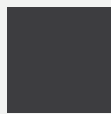

Linoleum  
4023  
Nero

Indicated materials and colours are selected by Gazzda as best-selling items and their lead time is shorter than of made-to-order options. Please consult the current price list or our customer service for the lead time of selected options.

For other material options, please see the Available materials section at the end of the product sheet.

# Fina Dresser 118 - with door

Body Solid oak, Fronts Linoleum, Legs Powder-coated steel

Version: 1-1-2023

## Basic info

<b>Design</b>	Mustafa Čohadžić
<b>Product size</b>	W: 118, D: 45, H: 100
<b>Packaging</b>	W: 121,5, D: 54, H: 86
<b>Volume</b>	0,56 m <sup>3</sup>
<b>Net weight</b>	51,8 kg
<b>Gross weight</b>	55,8 kg

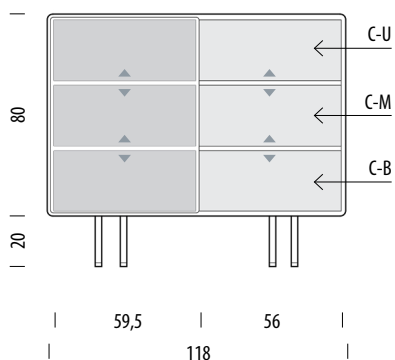

### Item no. 19F

Assembly 15 min / 2 persons

Internal storage	Width	Depth	Height
C-U (each)	56	41	21-27
C-M (each)	56	41	17-31
C-B (each)	56	41	21-27

- ▲ Shelves indicated with triangle arrows are height-adjustable and removable.
- ▼

# Fina Dresser 118 - with drawers

Body Solid oak, Fronts Linoleum, Legs Powder-coated steel

Version: 1-1-2023

## Basic info

<b>Design</b>	Mustafa Čohadžić
<b>Product size</b>	W: 118, D: 45, H: 100
<b>Packaging</b>	W: 121,5, D: 54, H: 86
<b>Volume</b>	0,56 m <sup>3</sup>
<b>Net weight</b>	59,5 kg
<b>Gross weight</b>	63,5 kg

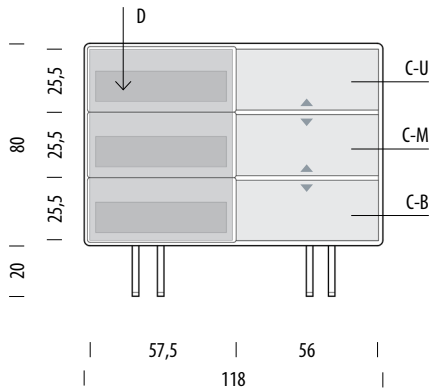

### Item no. 1A0

Assembly 15 min / 2 persons

Internal storage	Width	Depth	Height
D (each)	51,5	34,5	12
C-U	56	41	21-27
C-M	56	41	17-31
C-B	56	41	21-27

▲ Shelves indicated with triangle arrows are height-adjustable and removable.



# Fina Dresser 176

Body Solid oak, Fronts Linoleum, Legs Powder-coated steel

Version: 1-1-2023

## Basic info

**Design** Mustafa Čohadžić

**Product size** W: 176, D: 45, H: 100

**Packaging** W: 179, D: 54, H: 86

**Volume** 0,83 m<sup>3</sup>

**Net weight** 89,5 kg

**Gross weight** 94 kg

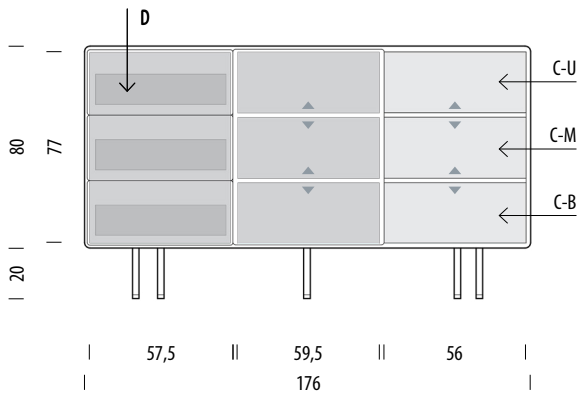

### Item no. 19E

Assembly 15 min / 2 persons

Internal storage	Width	Depth	Height
D (each)	51,5	34,5	12
C-U (each)	56	41	21-27
C-M (each)	56	41	17-31
C-B (each)	56	41	21-27

▲ Shelves indicated with triangle arrows are height-adjustable and removable.

# Fina Drawer 60

Body Solid oak, Fronts Linoleum, Legs Powder-coated steel

Version: 1-1-2023

## Basic info

<b>Design</b>	Mustafa Čohadžić
<b>Product size</b>	W: 60, D: 45, H: 100
<b>Packaging</b>	W: 63, D: 54, H: 86
<b>Volume</b>	0,29 m <sup>3</sup>
<b>Net weight</b>	37,5 kg
<b>Gross weight</b>	41,1 kg

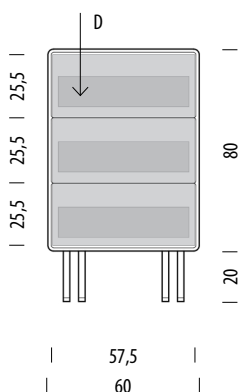

### Item no. 067

Assembly 15 min / 2 persons

Internal storage	Width	Depth	Height
D (each)	51,5	34,5	12

# Fina Nightstand

Body Solid oak, Fronts Linoleum, Legs Powder-coated steel

Version: 1-1-2023

## Basic info

<b>Design</b>	Mustafa Čohadžić
<b>Product size</b>	W: 55, D: 45, H: 40
<b>Packaging</b>	W: 58, D: 47,5, H: 26
<b>Volume</b>	0,07m <sup>3</sup>
<b>Net weight</b>	15,3 kg
<b>Gross weight</b>	16,6 kg

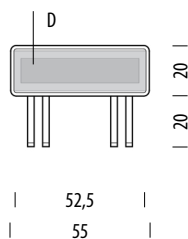

Item no. 068

Assembly 15 min / 1 person

Internal storage	Width	Depth	Height
D	46,5	34,5	10

# Fina storage units

Available materials

Version: 1-1-2023

## Body | Solid oak

---

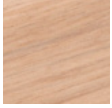

Oiled  
1015  
White oil

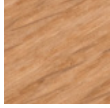

Oiled  
1505  
Natural oil

## Front panels | Desktop linoleum - by Forbo

---

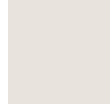

4176  
Mushroom



4023  
Nero