

BIOS

Diagnostics™/MC

PROFESSIONAL Office Scale

3-in-1 Body Analysis Scale
(Weight/Height/BMI)

Instruction Manual
Model: 200SC

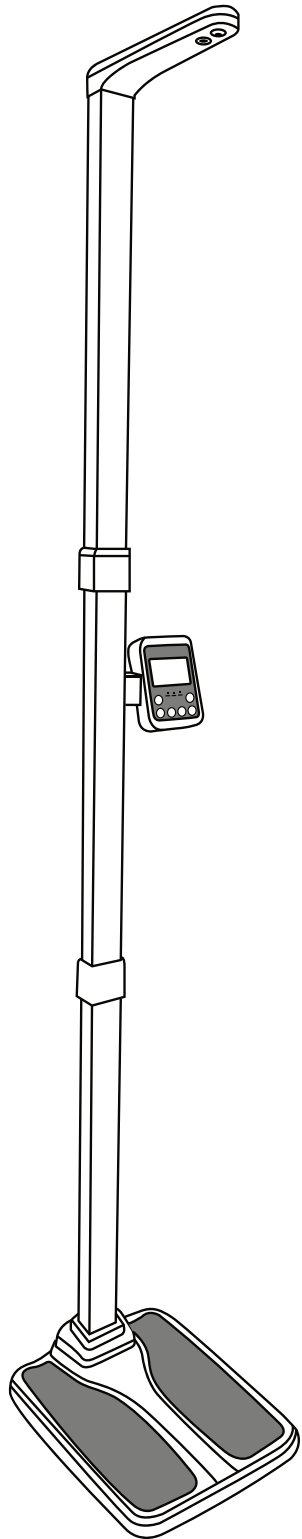
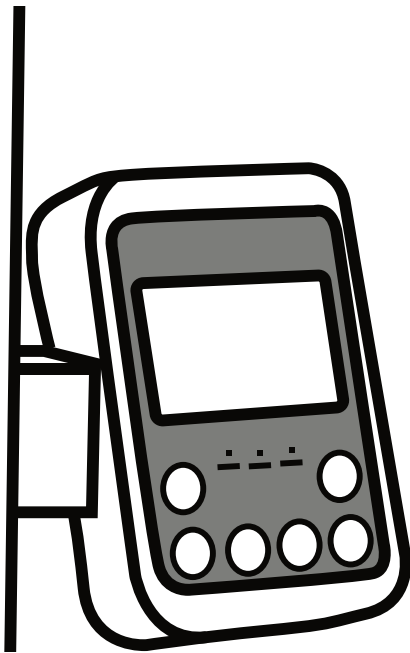

Professional Office Scale Instruction Manual

Table of Contents

1. Introduction

- 1.1 Features
- 1.2 General Warnings and Cautions

2. Getting Started

- 2.1 About the 200SC
- 2.2 About the LCD Screen
- 2.3 About the Buttons

3. Initial Setup

- 3.1 List of Components
- 3.2 Installation Instructions

4. Using the Device

- 4.1 Taking Measurements without Parameters Set Up
- 4.2 Taking Measurements with Parameters Set Up
- 4.3 Rotating the LCD Display
- 4.4 Charging the Battery

5. Error Messages / Malfunctions

6. Specifications

7. Limited Lifetime Warranty

1. Introduction

Thank you for purchasing the BIOS Diagnostics Professional Office Scale. This precision device has been developed with efficient office measurement in mind. It provides quick calculations of three key body qualities – weight, height, and BMI. This manual is a comprehensive guide designed to help you understand the capabilities and operation of the 200SC Professional Office Scale. Before using this device, carefully read this manual for setup, configuration, use, troubleshooting, and maintenance of the device.

1.1 Features

- 3-in-1 Body Analysis Scale (Weight, Height, BMI)
 - High precision load cells for weight measurement
 - High precision Ultrasonic Technology for height measurement
- Large LCD Display with Blue Backlight
- Voice Broadcast Function
- Easy Set-Up
- Overload Warning
- DC9V Adapter / Rechargeable Lithium Battery

1.2 General Warnings and Cautions

1. Ensure that the scale is placed on flat, even, and solid ground before turning on. Avoid carpet or soft surfaces, as uneven floors may affect the reading.
2. Clear anything over 35.4"/90 cm in height from the immediate vicinity (this may affect patient's height accuracy)
3. During measurements, stand straight, and as still as possible. Do not jump on the platform.
4. Do not use if patient or floor around the device is wet. Keep scale in a dry place, to protect the electronic components.
5. This unit is a precision device, handle with care, and move carefully to prevent damage. Avoid excessive impact or vibration to the unit.
6. To clean, wipe unit with a soft damp cloth. Do not allow water to enter the scale. Do not use chemical reagents to clean.
7. Do not disassemble the scale components. Doing so will automatically void the warranty.

2. Getting Started

2.1 About the 200SC

This section describes the various components of the Professional Office Scale.

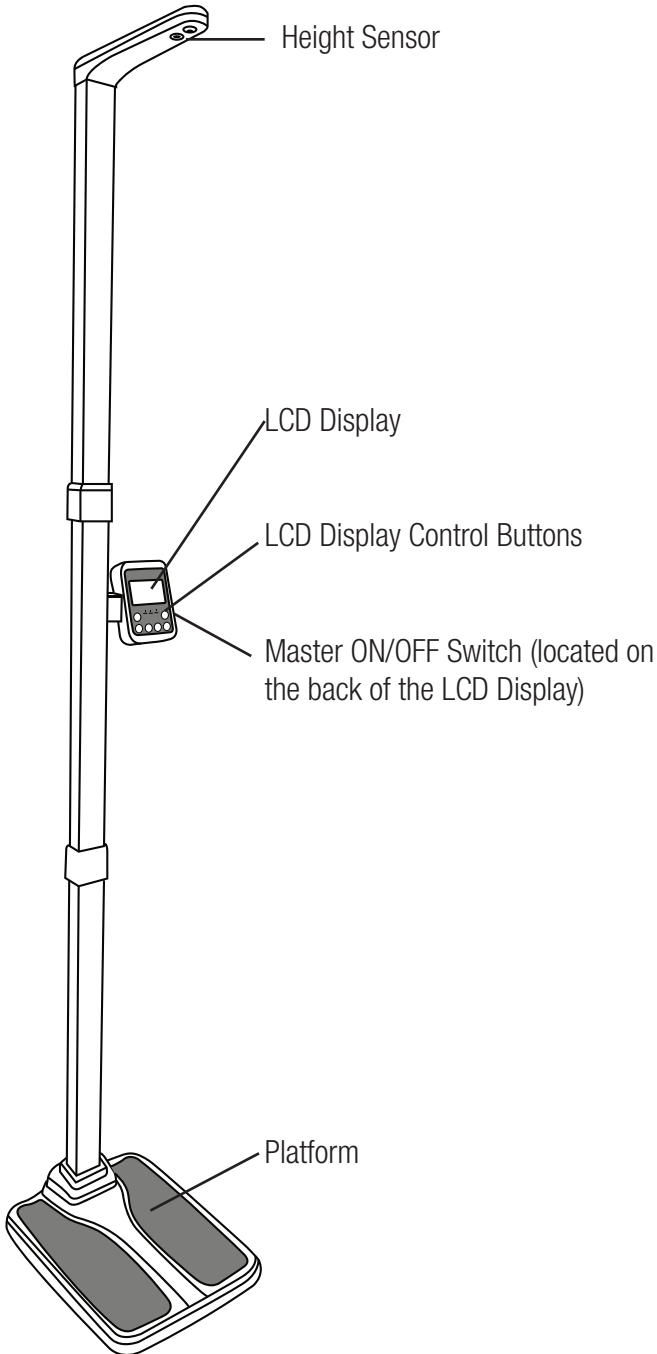

2.2 About the LCD Screen

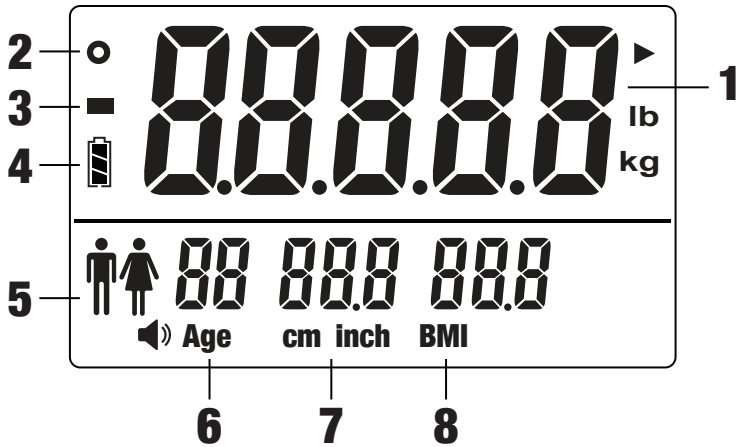

1. Weight

- Shows weight displayed in pounds (lbs) or kilograms (kgs) as set by the user.

2. Stability Symbol

- Denotes when the weight measurement on the scale has stabilized. The number will no longer change.

NOTE: Note weight down, or save in memory before stepping off (see 2.3 (4a)). Scale will return to 0.00 when weight is removed.

3. Minus Sign

- Denotes that weight is under 0.00 lbs/kgs. If a negative weight reading appears, press the **ON/TARE/+** button to return the scale to 0.00 lbs/kgs.

4. Battery Indication

- This shows the level at which the battery is charged.

5. Gender

- This shows the input selection of patient's gender.

NOTE: If patient's gender identity is self-assigned, use the sex of the patient at birth to determine selection choice. Or, follow instructions for "Taking Measurements without Parameters Set Up (4.1)".

6. Age

- This shows the input selection of the patient's age.

7. Height

- This shows the calculated height of the patient once the measurement has been taken in centimeters (cm) or inches (inch) as set by the user.

8. BMI

- Shows the calculated BMI of the patient once the measurement has been determined.
- To better understand your BMI reading, please refer to the list below.

- i. Underweight – BMI less than 18.5
- ii. Normal Weight – BMI 18.5 – 24.9
- iii. Overweight – BMI 25 – 29.9
- iv. Obese – BMI 30 +

NOTE: BMI is a ratio of weight-to-height. The calculation to determine BMI = kg/m^2 (a person's weight in kilograms divided by their height in metres squared).

2.3 About the Buttons

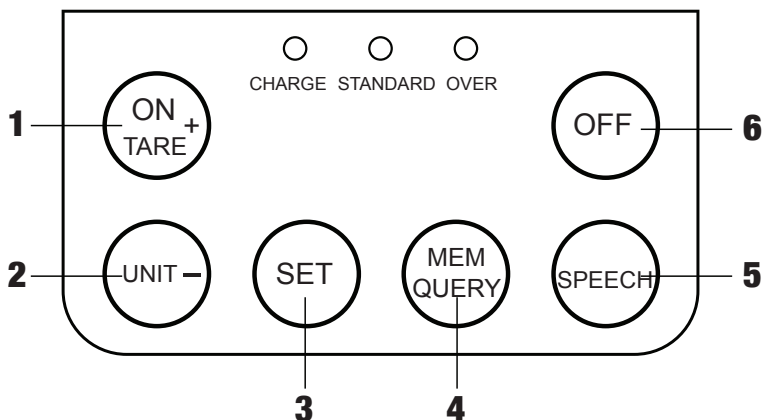

1. ON/TARE/+ Button

- a. When LCD display is turned off (Master Switch remains in the on position), click this button to turn the display ON. The screen will show a 0.00 lbs/kgs weight.



- b. In the case that the scale displays a number other than 0.00 lbs/kgs, please press this button again to tare the weight, and return it to 0.00 lbs/kgs.
- c. When setting parameters, use this button to increase the selection.
- d. When in the query/memory parameter, use this button to increase the selection.

2. UNIT/- Button

- a. When scale is turned ON, use this button to alternate between measurement units (lbs/in, kgs/cm).



- b. When setting parameters, use this button to decrease the selection.
- c. When in the query/memory parameter, use this button to decrease the selection.

3. SET Button

- a. When the scale is turned ON, use this button to toggle through the gender, and age parameters. Then use the increase/decrease buttons to select choice. Hit the SET button to accept the selection.

4. MEM/QUERY Button

NOTE: The scale holds 7 measurements. Once the maximum capacity is reached, the oldest will be deleted as new measurements are saved.

- a. To save patient data in the memory after a measurement, have the patient stand still. Press the **MEM/QUERY** button. “**SAVE**” will appear on the screen.
- b. To view memories saved in the device, have the scale turned on, and no weight on the platform. Press and hold the **MEM/QUERY** button until “**SLUSE**” appears on the screen. Using the **ON/TARE/+** or the **UNIT/-** button cycle through the data until you find the parameters of the patient you are looking for (Gender/Age). Hit **MEM/QUERY** button again, and the weight will appear on the display.
- c. To exit the **MEM/QUERY** state after viewing a measurement, simply press the **MEM/QUERY** button again.

5. SPEECH Button

- a. When the scale is turned ON, use this button to switch the Voice Broadcast feature ON/OFF.
- b. By default, this setting is turned OFF, until manually switched ON.

6. OFF Button

- a. When the scale is turned ON, use this button to turn the LCD screen OFF.

3. Initial Set Up

3.1 List of Components

- 1 x Platform (A)
- 3 x Column Sections (B/C/D)
- 2 x Sleeve Cover (E)
- 1 x Decorative Surface Shell (F)
- 8 x M5 Large Phillips-Head Screws (S1)
- 4 x M6 Hexagon Screws (S2)
- 1 x 2 Sided Key (Phillips & Hexagon)

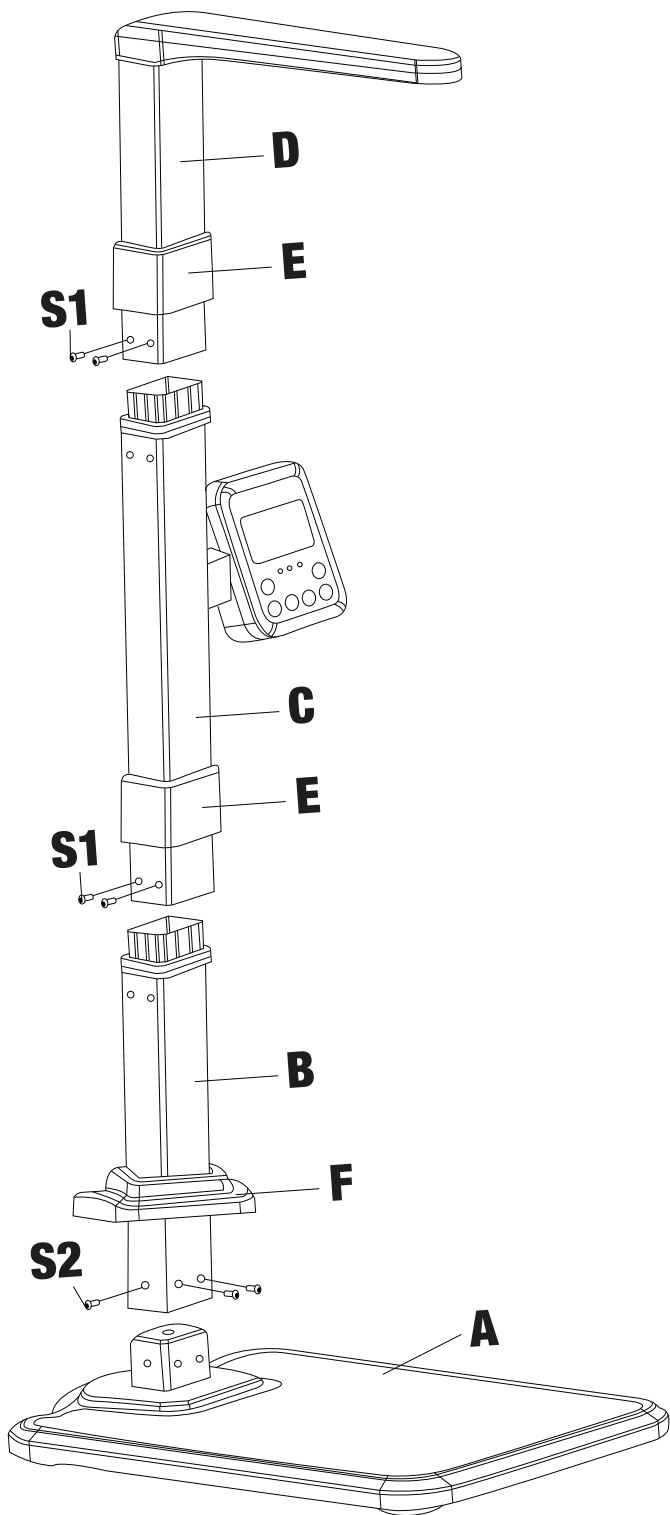

3.2 Installation Instructions

1. Remove all components from the box, and lay out for easy access.
2. Starting with the 3 column pieces (**B/C/D**), align, and connect the bottom of column C (the column piece with the LCD screen), to the top of column B.
NOTE: Ensure that the wiring from column C is thread down through column B before screwing them together.
 - a. Lock these columns in place by screwing in 4 x **S1** (Large Phillips-Head Screws).
 - b. Slide **E** (Sleeve Cover) down to cover the connecting sections and visible screws.
3. Next, take column piece **D** (the column piece with the height sensor), and connect the bottom of the column to the top of column piece **C** (the column piece with the LCD screen).
 - a. Lock these columns in place by screwing in 4 x **S1** (Large Phillips-Head Screws).
 - b. Slide **E** (Sleeve Cover) down to cover the connecting sections and visible screws.
4. With the completed column pieces now connected, make sure that **F** (Decorative Surface Shell) is slid onto the bottom of column piece **B** before moving on to the next step.
5. Connect the plug at the end of column **B**, to the plug socket on **A** (Platform).
NOTE: The plug and the plug socket line up with a small cut out. Please match them up before pressing the plug in.
6. Place the completed column assembly onto the corresponding elevated knob on **A** (Platform).
 - a. Lock the column assembly into place by screwing in 4 x **S2** (M6 Hexagon Screws).
 - b. Slide **F** (Decorative Surface Shell) downwards into the corresponding assembly holes on **A** (Platform).
7. After assembly is complete, carefully lift the scale, and place on level ground.

4. Using the Device

NOTE: Measurements can be taken with or without setting the Gender and Age parameters.

4.1 Taking Measurements without Parameters Set Up

1. Ensure the Master Power Switch is set to ON, on the back of the LCD Display.
2. Turn the scale ON using the **ON/TARE/+** button. If needed press this button again to TARE the scale back to 0.00 lbs/kgs.

3. Have patient stand in the center of the platform, standing up straight, and looking ahead.
NOTE: Make sure patient stands still, and remains on the platform until the numbers have stopped changing on the screen.
4. Turn the LCD screen OFF by pressing the **OFF** button when finished noting down measurements.

4.2 Taking Measurements with Parameters Set Up

1. Ensure the Master Power Switch is set to ON, on the back of the LCD Display.
2. Turn the scale ON using the **ON/TARE/+** button. If needed press this button again to TARE the scale back to 0.00 lbs/kgs.
3. Set Measurement Parameters
 - a. **Gender:** Press **SET** button until the male/female icon flashes, press **ON/TARE/+** button or **UNIT/-** button to make gender selection, press **SET** button again to confirm choice.
 - b. **Age:** Press **SET** button until the age icon flashes, press **ON/TARE/+** button or **UNIT/-** button to make changes to the patient's age. Press **SET** button again to confirm choice.
4. Have patient stand in the center of the platform, standing up straight, and looking ahead.
NOTE: Make sure patient stands still, and remains on the platform until the numbers have stopped changing on the screen.
5. Turn the LCD screen OFF by pressing the **OFF** button when finished noting down measurements.

4.3 Rotating the LCD Display

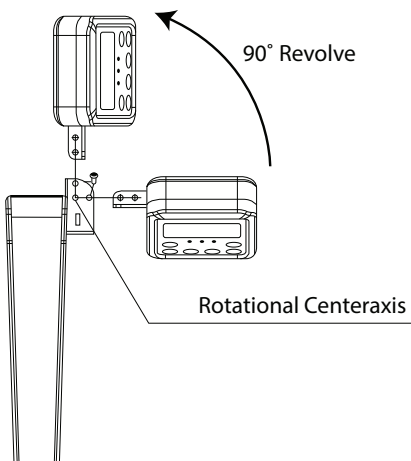

The LCD display can be rotated 90° backwards.

To rotate the LCD screen:

1. Unscrew, and completely remove the black headed knurled screw from the top of the LCD hinge.
2. Using a firm grip, guide the LCD screen backwards (or forwards if already in the backward position) 90°, so that the knurled screw can now enter into the newly aligned holes.
3. Screw the knurled screw back into the top of the LCD hinge until tight.

NOTE: The LCD screen should be rotated back 90° if the patient is under 3'11"/120 cm in height, so as to not interfere with the height calculation.

4.4 Charging the Battery

When the LCD display shows  , please be sure to charge the scale in a timely manner. When the display shows "LO", please charge immediately. The charging interface (adapter plug in) is on the backside of the LCD display.

When the scale is plugged in via the power adapter, the charging indicator light will illuminate, to confirm that the battery is charging. ONLY charge the scale with the originally supplied power adapter (the use of another adapter who's technical parameters may not meet the device's requirements may cause damage to the scale).

5. Error Messages and Malfunctions

Error Message/Code	Reasoning	Troubleshooting
	Power supply is low	Plug the unit in to charge
LO	Power supply is extremely low	Plug the unit in to charge
-H-	Weight exceeds measuring range	Step off, and use another form of weight measurement
UnSt	Device is unstable	Move device to flat, solid ground
HHH	Height exceeds measuring range	Step off, and use another form of height measurement
LLL	Height exceeds measuring range	Step off, and use another form of height measurement

6. Specifications

Platform Size	19" x 14" (48.3 cm x 35.8 cm)
Weight Measurement Units	lbs / kgs
Maximum Weight Capacity	440 lbs / 200 kgs
Minimum Weight Capacity	11 lbs / 5 kg
Weight Graduation	0.2 lbs / 100 g
Weight Accuracy	0-50kg:±300g 50.1kg-100kg:±400g 100.1kg-150kg:±600g 150.1kg-200kg:±800g
Height Measurement Range	2'11" – 6'7" (90 cm – 200 cm)
Height Accuracy	+/- 2 cm
Power Supply	7.4v/2600mah lithium battery
Adapter Type	Input 110-240 VAC Output 9VDC / 1A
Charging Type	DC Interface
Overall Dimensions	19"(D) x 14"(W) x 87"(H)

7. Limited Lifetime Warranty

The BIOS Diagnostics Professional Office Scale has a limited lifetime warranty to be free of manufacturing defects in materials and workmanship under normal applications of the original owner. If this product becomes inoperable due to defect, return the product with all component pieces and proof of purchase to the address listed below. This warranty does not cover any shipping/transport costs. This warranty does not apply if the product is subject to misuse, neglect, rough handling or damage.

100% Satisfaction Guarantee

If at any time, you are not completely satisfied with the performance of this device, call our BIOS Medical Hotline and speak with a customer service representative, who will make arrangements to have the device tested or replaced to your full satisfaction.

If you have questions regarding the operation of your scale call the BIOS Medical Hotline: 1-866-536-2289.

Should correction be necessary, return the unit with all component pieces. Enclose proof of purchase and \$5.00 for return shipping and insurance.

Ship the unit prepaid and insured (at owner's option) to:

Thermor Ltd.

Attn: Returns Department

16975 Leslie Street

Newmarket, ON L3Y 9A1

www.biosmedical.com

Email: support@biosmedical.com

BIOS | Medical

MANUFACTURED BY / FABRIQUÉ PAR :

THERMOR LTD.

16975 LESLIE STREET

NEWMARKET, ON L3Y 9A1

MADE IN CHINA / FABRIQUÉ EN CHINE

WWW.BIOSMEDICAL.COM

