



Parts Included

Quantity	Item Description	Part#
1	Driver Rear Shock	DK-636889R RL
1	Passenger Rear Shock	DK-636889R RR

Please check that all items are present before installation. If for any reason there is an item or items missing send an email to sales@dirtking.com with proof of purchase and a picture of parts received.



Before installing, read all instructions. Only certified mechanics should install Dirt King products. Mandatory wheel alignment and ADAS calibration at certified facilities are required after suspension modifications. Failure to do so can lead to handling problems and safety risks. Dirt King is not responsible for damages from improper installation or misuse. Adhere to your vehicle manufacturer's recommendations. For more information, visit <https://dirtking.com/pages/disclaimer>

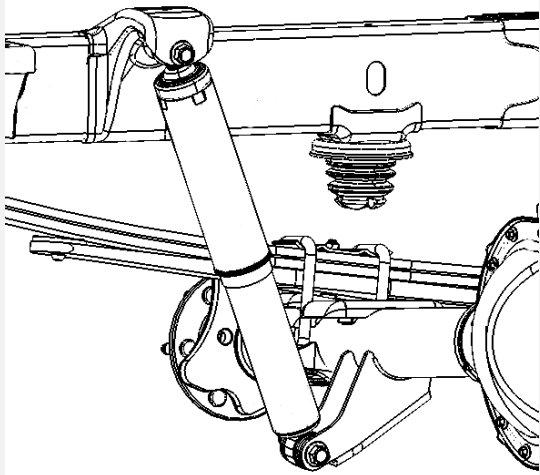

Step 1: Remove Rear Shocks

- Remove lower shock hardware.
- Remove upper shock hardware.
- Remove shock from vehicle.

Left side shown

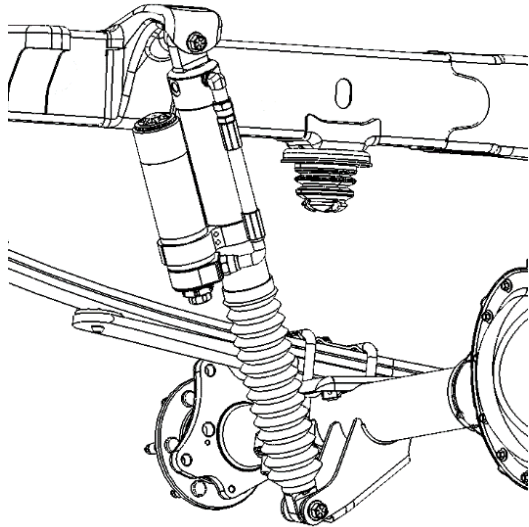

Step 2: Install Dirt King Shocks

- Identify the shocks: the left side shock has the reservoir aligned with the top cap and should be mounted with the reservoir towards the vehicle's rear; the shock on the right side has the reservoir offset from the top cap and should be mounted with the reservoir towards the front of the vehicle. Install shock to the upper mount using factory hardware and torque to **70ft lbs.**
- Install shock into lower mount using the factory hardware and torque to **118ft lbs.**

Left side shock

Right side shock



For warnings and disclaimers visit <https://dirtking.com/pages/disclaimer>.