



**SDHQ Motorsports**  
**190 S McQueen Rd**  
**Ste 109 Gilbert, AZ 85233**  
**Phone: 480-633-2929**

---

## Product Packing List

**Product:** SDHQ-23-1130-JL

**Description:** Jeep JL Switch Pros Keypad Mount

_____ (1) SDHQ Jeep JL Switch Pros Mount	SDHQ-23-1130-JL-A
_____ (1) Hardware Package	SDHQ-23-1130-JL-B
_____ (4) #10 - 24 x 1" S.S. Socket Head Screws	
_____ (4) #10 - 24 S.S. Nylock Nuts	
_____ (4) #10 S.S. SAE Washers	

**Inspected and Packaged By:** \_\_\_\_\_ **Date:** \_\_\_\_\_

For questions or help with the installation, please call SDHQ Offroad @ 480-633-2929  
Mon.-Fri. 8:00am-5:30pm and Sat. 8:00am-3:30pm Arizona Time. [www.sdhqoffroad.com](http://www.sdhqoffroad.com)

**For questions or help with the installation, please call SDHQ Offroad @ 480-633-2929  
Mon.–Fri. 8:00am–5:30pm and Sat. 8:00am–3:30pm Arizona Time. [www.sdhqoffroad.com](http://www.sdhqoffroad.com)**



SDHQ Motorsports  
 190 S McQueen Rd  
 Ste 109 Gilbert, AZ 85233  
 Phone: 480-633-2929

## INSTALLATION INSTRUCTIONS

**Product:** SDHQ-23-1130-JL

**Description:** Jeep JL Switch Pros Keypad Mount

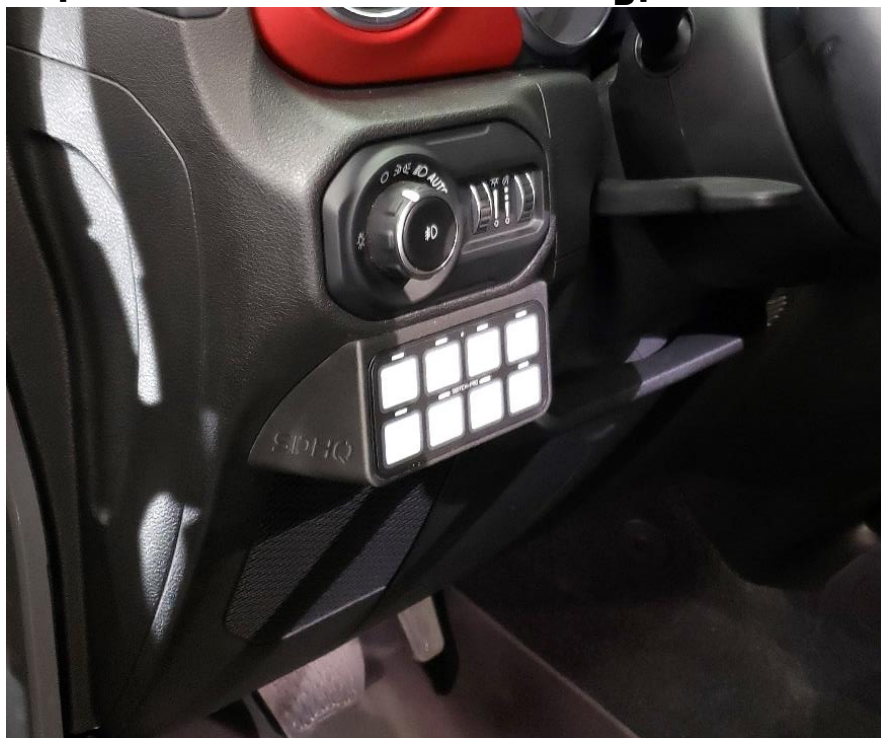

<u>Parts List</u>	<u>Hardware List</u>	<u>Required Tools</u>
(1) SDHQ Jeep JL Switch Pros Mount SDHQ-23-1130-JL-A (1) Hardware Package SDHQ-23-1130-JL-B	(4) #10 - 24 x 1" S.S Socket Head Screws (4) #10 - 24 S.S. Nylock Nuts (4) #10 S.S. SAE Washers	7mm Wrench 8mm Socket Panel Removing tool Phillips Screwdriver 5/32" Drill & Drill Bit Dremel

### **Tech Notes**

Drilling into the driver side speaker panel is required  
 \*\*Approximate install time = 1 ½ hours (not including wiring)\*\*

For questions or help with the installation, please call SDHQ Offroad @ 480-633-2929  
 Mon.–Fri. 8:00am–5:30pm and Sat. 8:00am–3:30pm Arizona Time. [www.sdhqoffroad.com](http://www.sdhqoffroad.com)

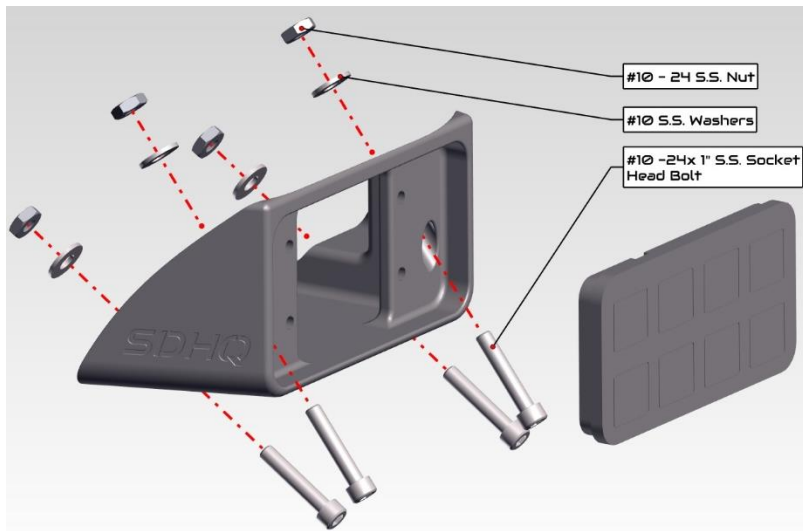

**\*\*\*READ ALL INSTRUCTIONS THOROUGHLY FROM START TO FINISH BEFORE BEGINNING INSTALLATION! \*\*\***

## **Installation Instructions:**

1. Unbox all of the parts and familiarize yourself with them.
2. Start by removing the climate control panel using a panel removing tool.



3. Next, remove the 2 screws Pictured below using either a Philips screwdriver, or a 7mm wrench and pry apart the media control panel as shown.



For questions or help with the installation, please call SDHQ Offroad @ 480-633-2929  
 Mon.–Fri. 8:00am–5:30pm and Sat. 8:00am–3:30pm Arizona Time. [www.sdhqoffroad.com](http://www.sdhqoffroad.com)

4. Next, the top dash panel can be pried off after removing the screw above the media controls. Start from the driver side and work towards the passenger side.



5. Remove the (4) screws holding the top of the gauge cluster panel and pry off.

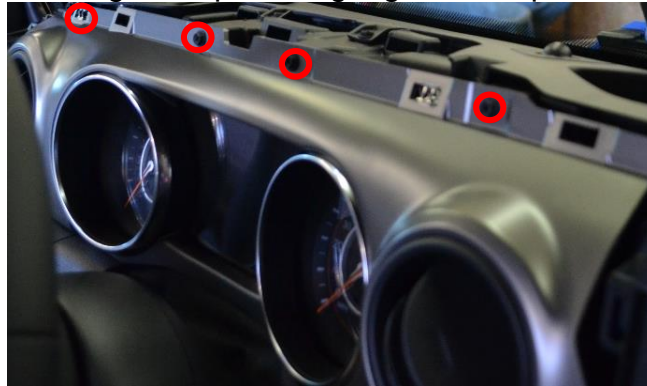

6. Now the driver side panel can be pried off revealing the (6) screws holding the speaker panel in place. Remove the (6) screws holding in the speaker panel.



7. Now remove the (2) screws holding the top of the driver side speaker panel in place.

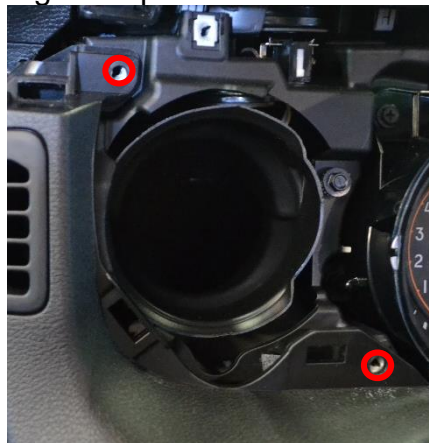

8. Pry the bottom kick panel off and remove the screw holding the speaker panel in place.

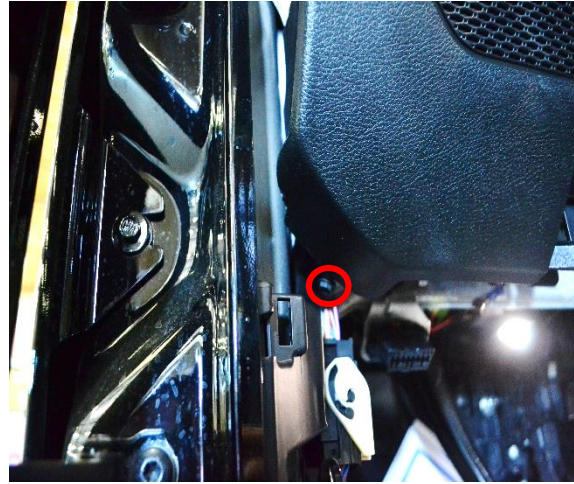

9. Then remove the two panels under the steering wheel to reveal the (3) remaining screws holding the speaker panel in place. Remove the remaining (3) screws.

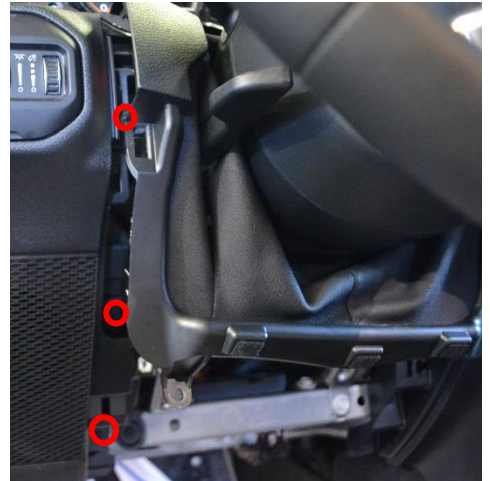

10. Pull the Speaker panel off and disconnect the light switch connector.

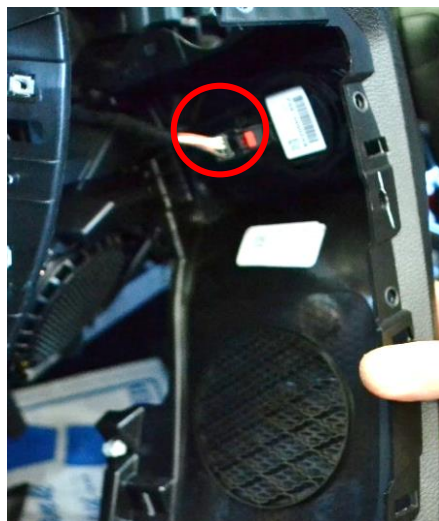

**11. Preparing the mount.** Align the SDHQ JL Switch Pros Mount to the speaker panel and mark the 4 holes dotted below to be drilled. Drill out holes with a 5/32" drill bit. Use a Dremel to cut out the rectangular portion in between the drilled holes.

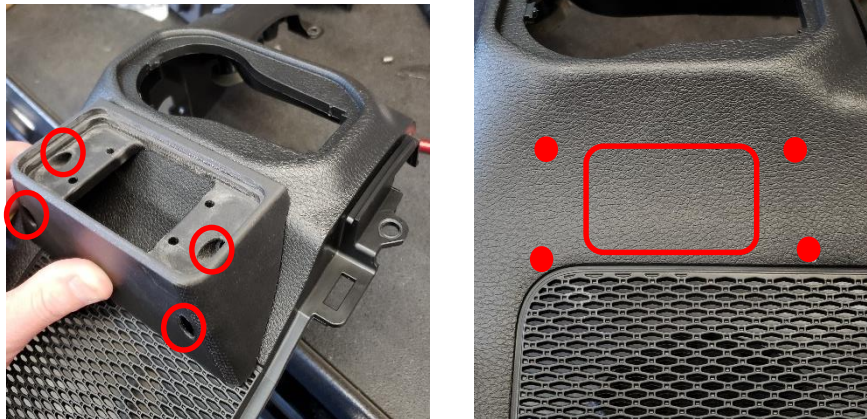

**12. Mounting the Switch Pros Mount.** Once the marked holes are drilled out, use the provided hardware to mount the SDHQ JL Switch Pros Mount to the speaker panel.

**13.** Thread the (4) Switch Pro provided studs into the back of the Switch Pro Keypad. Thread the Switch Pros supplied nylock nuts on to the studs and tighten by hand with the 8mm socket. Use the drawing on Page 4 as a reference for installing the Switch Pro Keypad.



**14. Reinstalling the dash panels.** Follow the steps provided from operations 2-10 in reverse order to complete the installation.

**15. Wire Switch Pros and Enjoy!**

**\*\*\*Double check all hardware is installed correctly and tight\*\*\***

**\*\*\*Re-torque ALL bolts after 100 miles\*\*\***



190 S McQueen Rd  
Ste 109 Gilbert, AZ 85233  
Phone: 480-633-2929 | Fax: 480-633-1791  
[www.sdhqoffroad.com](http://www.sdhqoffroad.com)

Follow us on:



Facebook



Instagram

For questions or help with the installation, please call SDHQ Offroad @ 480-633-2929  
Mon.–Fri. 8:00am–5:30pm and Sat. 8:00am–3:30pm Arizona Time. [www.sdhqoffroad.com](http://www.sdhqoffroad.com)