



SDHQ Motorsports
190 S McQueen Rd
Ste 109 Gilbert, AZ 85233
www.SDHQoffroad.com

Product Packing List

Product: SDHQ-14-1212-G6

Description: 2021-Current Ford Bronco & 2022-Current Bronco Raptor 3rd Brake Light Chase Light Mount

- | | | |
|-------|--|--------------------|
| _____ | (1) Ford Bronco Chase Light Mount | SDHQ-14-1212-G6-A |
| _____ | (1) Ford Bronco Chase Light Mount Reinforcement | SDHQ-14-1212-G6-B |
| _____ | (1) Hardware Package | SDHQ-14-1212-G6-HP |
| _____ | (4) S.S. 5/16"-18 Nylon Insert Locknuts | |
| _____ | (4) S.S. Button Head 5/16"-18 x 1" Bolts | |
| _____ | (4) S.S. 3/8"-16 Nylon Insert Locknuts | |
| _____ | (4) S.S Button Head Hex 3/8"-16 x 1" Bolts | |
| _____ | (4) S.S. Washers for 3/8" Screw Size | |
| _____ | (2) S.S. Tamper-Resistant Button Head 1/4"-20 x 1/2" Bolts | |
| _____ | (2) S.S. Spring Lock Washers for 1/4" Screw Size | |
| _____ | (2) T-Slotted Framing Nuts 1/4"-20 Thread | |
| _____ | (1) Daystar Tailgate Bumpstop | |
| _____ | (1) Bumpstop Nut | |
| _____ | (5) Push-In Zip Ties | |

Inspected and Packaged By: _____ Date: _____

For questions or help with the installation, please email help@sdhqoffroad.com
Store front hours: Mon. – Fri. 8:00am – 5:30pm and Sat. 9:00am – 2:00pm Arizona Time.



SDHQ Motorsports
 190 S McQueen Rd
 Ste 109 Gilbert, AZ 85233
www.SDHQoffroad.com

INSTALLATION INSTRUCTIONS

Product: SDHQ-14-1212-G6

Description: 2021-Current Ford Bronco & 2022-Current Bronco Raptor 3rd Brake Light Chase Light Mount



Parts List	Hardware List	Required Tools
(1) Ford Bronco Chase Light Mount SDHQ-14-1212-G6 (1) Ford Bronco Chase Light Mount Reinforcement SDHQ-14-1212-G6-B (1) Hardware Package SDHQ-14-1212-G6-HP	(4) S.S. 5/16"-18 Nylon Insert Locknuts (4) S.S. Button Head 5/16"-18 x 1" Bolts (4) S.S. 3/8"-16 Nylon Insert Locknuts (4) S.S Button Head Hex 3/8"-16 x 1" Bolts (4) S.S. Washers for 3/8" Screw Size (2) S.S. Tamper-Resistant Button Head 1/4"-20 x 1/2" Bolts (2) S.S. Spring Lock Washers for 1/4" Screw Size (2) T-Slotted Framing Nuts 1/4"-20 Thread (1) Daystar Tailgate Bumpstop (1) Bumpstop Nut (5) Push-In Zip Ties	9/16", 1/2" End Wrenches Ratchet 3/16", 7/32" Allen Key Sockets TR27 Socket T25&T30 Sockets

Tech Notes

See the end of these instructions for wiring information
 Fits all OEM wheel/tire sizes. Designed for 16/17" wheels with a maximum backspace of 6-3/16" (+55mm)
 Fits either bolt pattern of OEM Tire Carrier
 Designed for 3rd Brake light to be replaced with Baja Designs RTL-M without license plate light
 Chase lights designed to use Baja Designs S1/S2 or Squadron
 Approx. Install Time: ~2 Hours (not including wiring)

*****READ ALL INSTRUCTIONS THOROUGHLY FROM START TO FINISH BEFORE BEGINNING INSTALLATION! ****

For questions or help with the installation, please email help@sdhqoffroad.com
 Store front hours: Mon. – Fri. 8:00am – 5:30pm and Sat. 9:00am – 2:00pm Arizona Time.

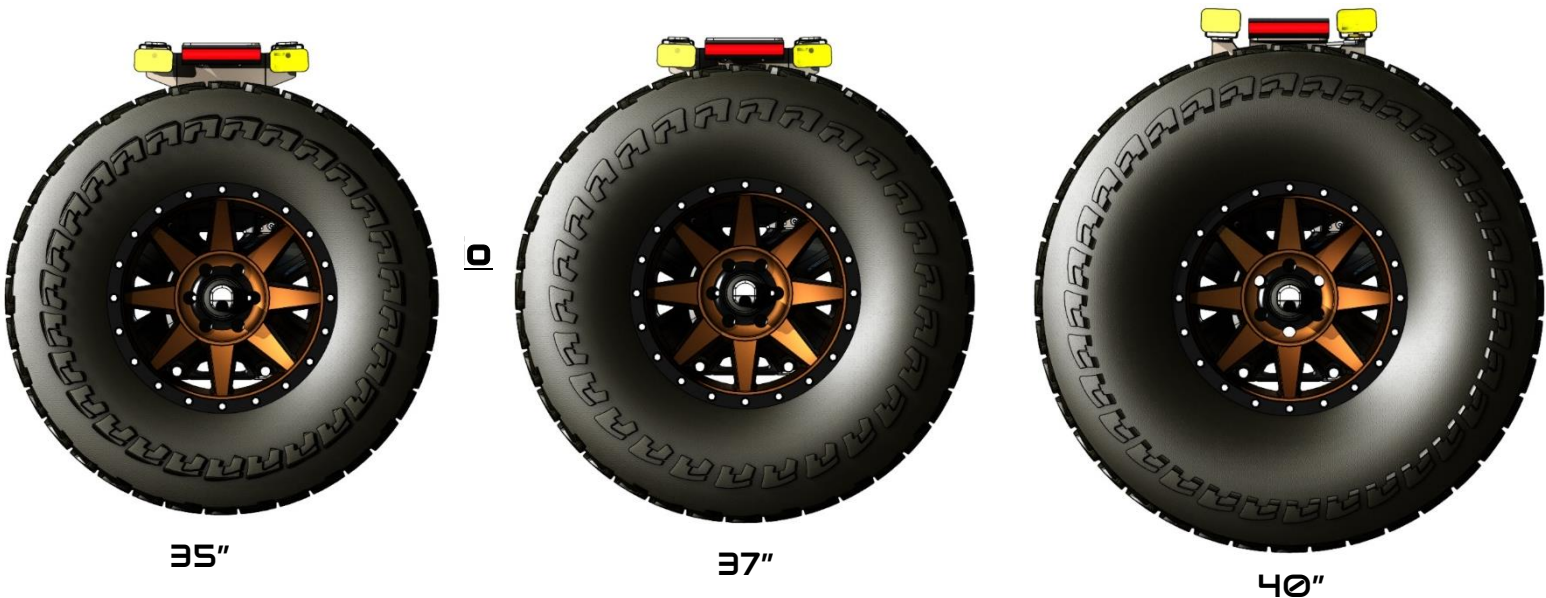
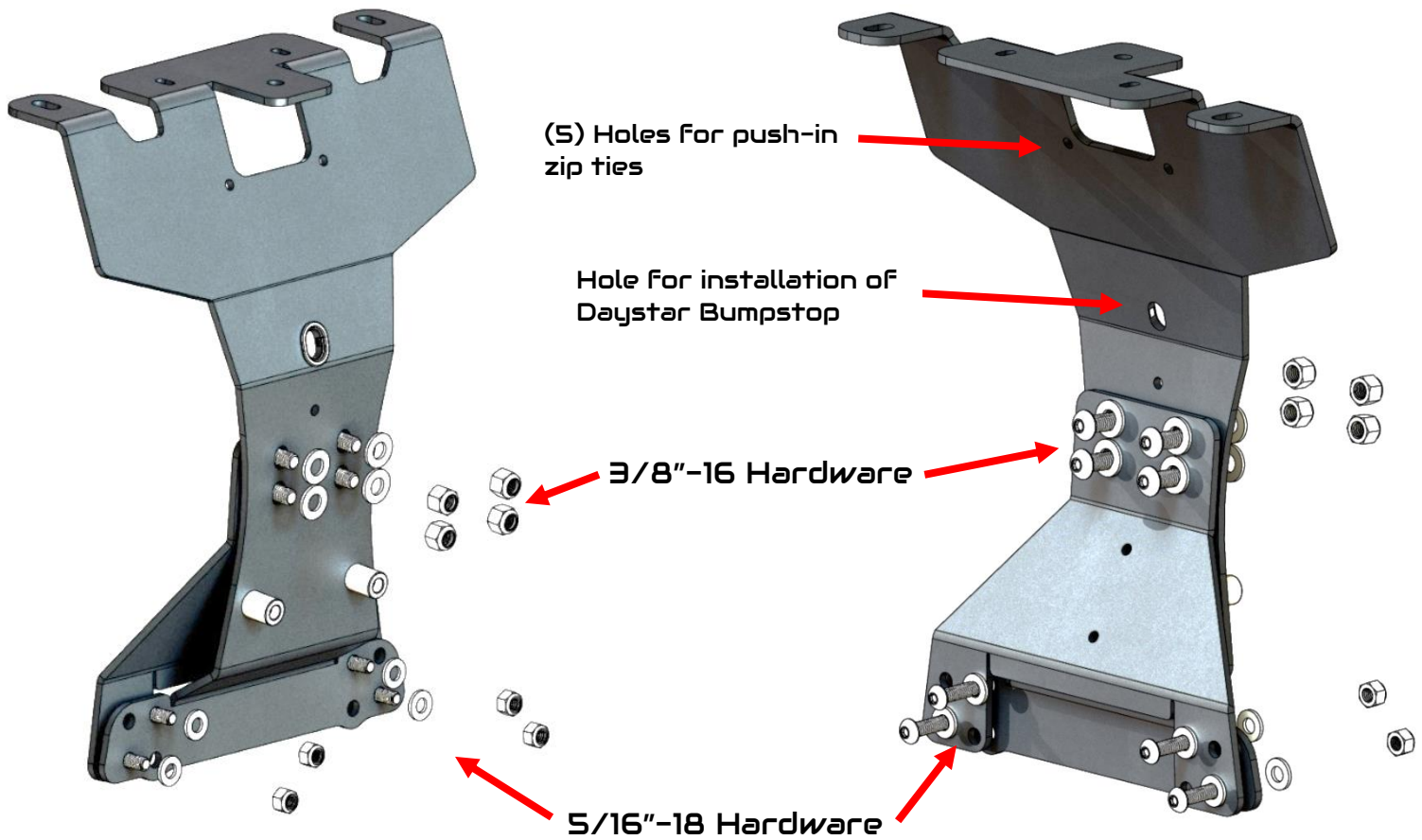

For 40" tires, Flip the lights to the top side of the mount

If running lights that are larger S2's, we recommend only installing lights on the top side of the mount

For questions or help with the installation, please email help@sdhqoffroad.com
 Store front hours: Mon. – Fri. 8:00am – 5:30pm and Sat. 9:00am – 2:00pm Arizona Time.

1. Remove spare and familiarize yourself with all your parts.
2. Unbolt 3rd brake lights (4) T30 bolts and remove the (8) T25 screws holding the brake light together to remove the connector and separate the OEM brake light from the tire carrier.



Bronco Raptor: Unbolt the (4) T30 bolts holding down the 3rd brake light and lean the light forwards to gain access to the (9) T25 bolts holding the housing together. Remove all of the T25 bolts and separate the 3rd brake light housing. Unclip the wire connector and set the housing to the side.



3. Loosely bolt together the two Chase Light Mount pieces using the 3/8" hardware and place onto the tire carrier.
4. Use the 5/16 hardware to bolt the Chase Light Mount to the OEM tire carrier, tighten 3/8" hardware.
5. Temporarily re-install your spare tire and measure the distance between the bump stop mounting hole and your spare tire. Take that measurement and trim your Daystar bump stop at least 1/8" longer.
6. Remove the spare and insert the trimmed bump stop into the mount as shown. Secure it using the supplied Daystar Nut.



7. Pause now to wire your lights, If you purchased a Baja Designs Harness **14-1212-G6-BD** refer to the instructions on page 8 for wiring install. See page 7 to reference how to wire the lights if using a different light. We also recommend building your harness to be disconnected outside of the tailgate so tailgate removal is easier in the future.
8. Install RTL-M using the 1/4" anti-tamper hardware on the underside of the top flange (for 35"/37" tires) or on the topside (for 40" tires); similarly install your chase lights.
9. Connect all your lights, check operation and secure wiring to the mount using the push-in zip ties.

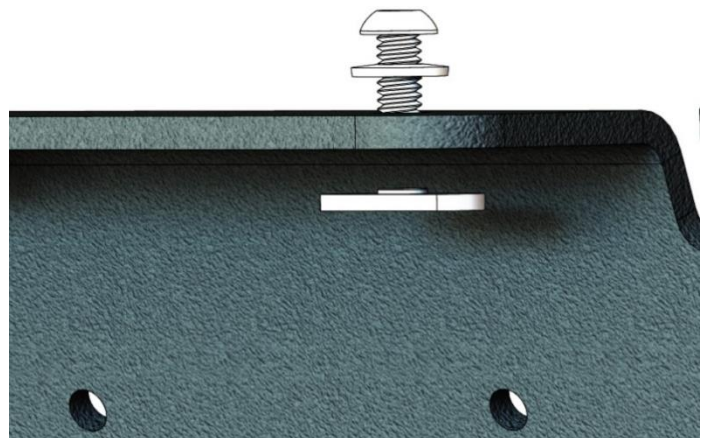

For questions or help with the installation, please email help@sdhqoffroad.com
 Store front hours: Mon. – Fri. 8:00am – 5:30pm and Sat. 9:00am – 2:00pm Arizona Time.

10. Reinstall your spare tire and enjoy your SDHQ Built 3rd Brake Light Chase Light Mount for your Ford Bronco!



Wiring:



WARNING:
Head and Tail Lamp circuits must not be modified or reconfigured in any way when using the factory supplied lamps. If using after market Head or Tail Lamps, or if circuits are modified or reconfigured, the vehicle alterer assumes all responsibility for vehicle compliance to lighting related regulations.

Head Lamp Connector

Head Lamp Pin Out Mating Connector: 10 way Male - Molex 33482-1601				
Function (4)	Pin #	Wire Color	Circuit Type	Max Current (2)
Low Beam	1	RH: BU / GN LH: BN / BU	Non-PWM	4.2 A
Turn	2	RH: YE/ VT LH: BU/ GN	Non-PWM	2.2 A
Turn Lamp Outage	4	RH: BU/ WT LH: YE/ GN	N/A	N/A
Lin Network	5	YE/ VT	Network	N/A
Daytime Running Lights	7	RH: VT / WT LH: GY / BU	Non-PWM	2.3 A
High Beam	8	RH: BU / GY LH: YE / VT	Non-PWM	20A Fused
Park	9	RH: BN / YE LH: GN / OG	Non-PWM	1.0 A
Ground	10	RH: BK / GY LH: BK / GN	N/A	N/A

- Notes**
- (1) Combined Load for RH and LH Lamps
 - (2) Continuous at 12V
 - (3) **Tail Lamp circuits are reconfigurable between separated and combined Stop and Turn***
 - (4) **Head Lamp circuit functions are reconfigurable in various ways***

*Requires a certified service technician with a Ford Diagnosis and Repair System (FDRS) tool.

Tail Lamp Connector

Tail Lamp Pin Out HALOGEN Mating Connector 6 way Male - Molex 33482-3602				
Function	Pin #	Wire Color	Circuit Type	Max Current (2)
Reverse	4	GN / BN	PWM	3.9 A (1)
Park	2	BU/ GY	PWM	1.6 A (1)
Stop / Turn (3)	3	RH: GY / VT LH: WH / GN	PWM	1.9 A
Ground	1	BK / GY	N/A	6.8 A

Tail Lamp Pin Out LED Mating Connector 6 way Male - Molex 33482-3602				
Function	Pin #	Wire Color	Circuit Type (3)	Max Current (2)
Reverse	4	GN / BN	Non-PWM	3.9 A (1)
Park	2	BU/ GY	Non-PWM	1.6 A (1)
Stop (3)	3	RH: BU / BN LH: BU / GN	Non-PWM	1.9 A
Turn (3)	5	RH: GN / OG LH: GY / OG	Non-PWM	1.9 A
Turn Lamp Outage	6	RH: BU / OG LH: GN / BU	N/A	N/A
Ground	1	BK / GY	N/A	6.8 A

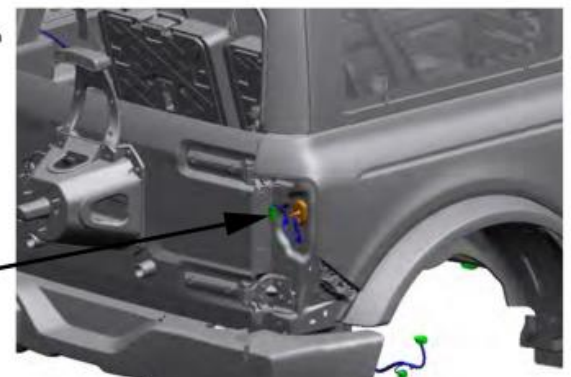

* If using another light wiring information shown above.

For questions or help with the installation, please email help@sdhqoffroad.com
 Store front hours: Mon. – Fri. 8:00am – 5:30pm and Sat. 9:00am – 2:00pm Arizona Time.



SDHQ Motorsports
190 S McQueen Rd
Ste 109 Gilbert, AZ 85233
www.SDHQoffroad.com

Product Packing List

Product: SDHQ-14-1212-G6-BD

Description: SDHQ Built 2021-Current Ford Bronco & 2022-Current Bronco Raptor 3rd Brake Light Chase Light Wiring Harness for Baja Design

_____ (1) Ford Bronco Baja Design Harness	SDHQ-14-1212-G6-BD
_____ (1) Hardware Package	SDHQ-14-1212-G6-BD-HP
_____ (1) DT04 Female 4-Plug Connector	
_____ (1) DT04 Female 4-Plug Wedge	
_____ (4) DT04 16-20g Male Terminals	
_____ (2) 16-14 Ga Non-Insulated Butt Connectors	
_____ (3) 1" Piece of 1/4" Heat Shrink	
_____ (1) 1" Piece of 1/2" Heat Shrink	

Inspected and Packaged By: _____ Date: _____

For questions or help with the installation, please email help@sdhqoffroad.com
Store front hours: Mon. – Fri. 8:00am – 5:30pm and Sat. 9:00am – 2:00pm Arizona Time.



SDHQ Motorsports
190 S McQueen Rd
Ste 109 Gilbert, AZ 85233
www.SDHQoffroad.com

INSTALLATION INSTRUCTIONS

Product: SDHQ-14-1212-G6-BD

Description: SDHQ Built 2021-Current Ford Bronco & 2022-Current Bronco Raptor 3rd Brake Light Chase Light Wiring Harness for Baja Designs

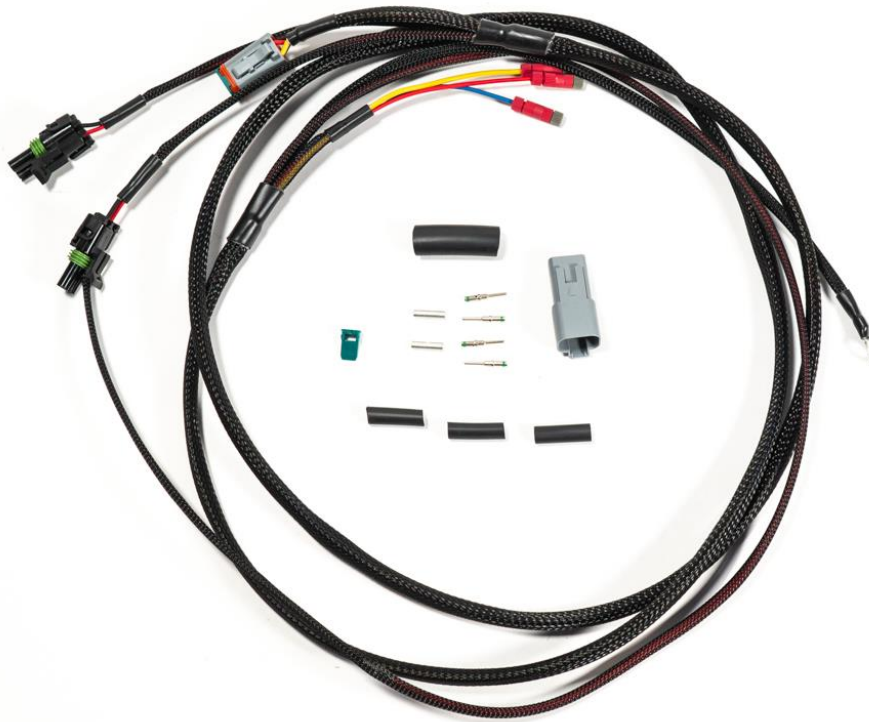

Parts List	Hardware List	Required Tools
(1) SDHQ Ford Bronco BD Harness SDHQ-14-1212-G6-BD (1) Hardware Package SDHQ-14-1212-G6-BD-HP	(1) DT04 Female 4-Plug Connector (1) DT04 Female 4-Plug Wedge (4) DT04 16-20g Male Terminals (2) 16-14 Ga Non-Insulated Butt Connector (3) 1" Piece of 1/4" Heat Shrink (1) 1" Piece of 1/2" Heat Shrink	Plastic Trim Removal Tools 8mm, 10mm Socket Ratchet Wire Crimpers Wire Strippers Knife

Tech Notes

Approx. Install Time: 1 Hour

***READ ALL INSTRUCTIONS THOROUGHLY FROM START TO FINISH BEFORE BEGINNING INSTALLATION! ***

For questions or help with the installation, please email help@sdhqoffroad.com
Store front hours: Mon. – Fri. 8:00am – 5:30pm and Sat. 9:00am – 2:00pm Arizona Time.

Installation Instructions:

1. Unbox your Wiring Harness and verify all parts are present.
2. Open the tailgate and remove the cargo liner if installed. Then using a plastic trim removal tool remove the (4) tie-down covers. Using a 10mm socket remove the (8) bolts retaining the (4) tie-downs and remove the tie-downs.



3. Remove the carpet panel by lifting the back edge and pulling toward the rear of the vehicle. Then remove the tailgate plastic trim using a plastic trim tool.

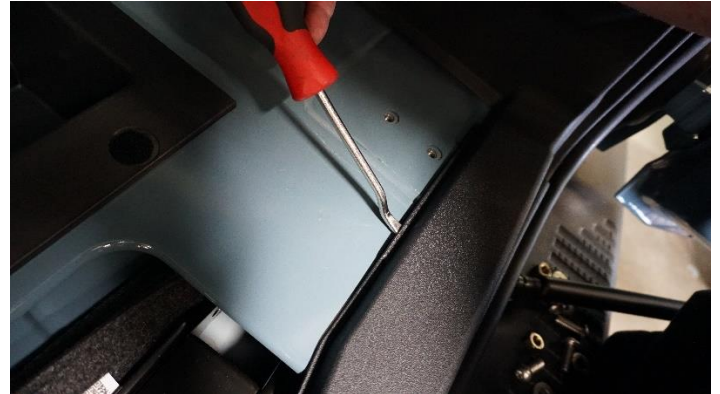

4. Release the rear seat backs so that they lean forward and out of the way. Remove the rear seat trim by pulling upward on the edges of the panel. Remove the passenger rear door sill panel using a plastic trim tool.



For questions or help with the installation, please email help@sdhqoffroad.com
Store front hours: Mon. – Fri. 8:00am – 5:30pm and Sat. 9:00am – 2:00pm Arizona Time.

5. Remove the passenger side trunk panel using plastic trim tools, there are 3 electrical connections on the backside of the panel that need to be disconnected to remove the panel.



6. Remove the two plastic panels on the inside of the tailgate using plastic trim tools.



- Push out the wiring grommet from the tailgate by pushing in the tabs. Remove the electrical tape and zip-tie from the outside of the grommet. Remove the rubber material on the outside of the grommet and cut the inside rubber to allow the harness to be run through the factory grommet hole.



- Feed the harness side with the eyelet and Posi-taps through the grommet from the outside. Pull the harness through the grommet until it can reach the connections for the RTL and chase lights with minimal slack.



- Use crimpers to crimp the male terminals onto the (4) wires for the RTL.
- Place the 1/2" piece of heat shrink over the wire ends. Using a knife cut back some of the insulation on the RTL wires to allow for the Deutsch connector to be pinned.
- Pin the Female Deutsch connector onto the RTL wires using the pin out, shown to the right. Once the pins are fully seated in the connector install the wedge into the connector to secure the pins.
- Using a heat gun secure the heat shrink over the opening of the RTL wires insulation.
- Connect the harness to the RTL and Chase Light connectors.

Pin Location	Wire Color
1	Red
2	Black
3	Blue
4	Yellow

11. Use push-in zip ties to secure the wiring for the lights. Loop the factory 3rd Brake light harness and zip tie it to the new harness behind the tire carrier to secure it. Zip tie the new harness to the factory harness as shown to secure it out of the way of the tire.



12. Disconnect the Black 20 pin connector and the Light Gray connector. Connect the Blue wire Posi-tap to the Green/Brown wire of the 20 pin connector. Connect the Red wire Posi-tap to the Blue/Gray wire of the 20 pin connector. Connect the Yellow wire Posi-tap onto the Yellow/Gray wire of the Light Gray connector.

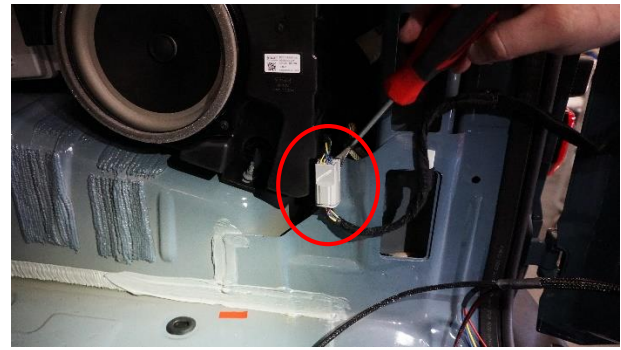

Connector	Wire Color	BD Harness Color
20 Pin	Green/Brown	Blue
20 Pin	Blue/Gray	Red
Light Gray	Yellow/Gray	Yellow

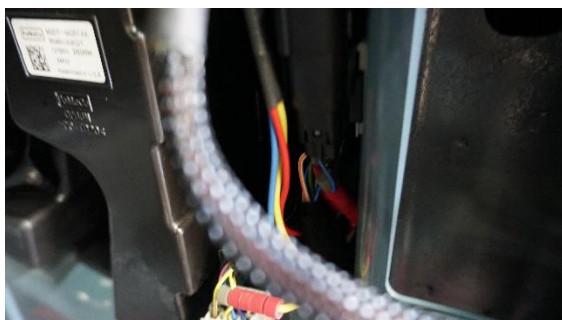

For questions or help with the installation, please email help@sdhqoffroad.com
 Store front hours: Mon. – Fri. 8:00am – 5:30pm and Sat. 9:00am – 2:00pm Arizona Time.

14. Use an 8mm socket to remove the bolt retaining the Ground wire to the chassis. Place the 1/4" eyelet over the chassis ground and reinstall the bolt retaining the grounds.



15. Slide (1) 1" piece of 1/4" heat shrink over the Red wires with the butt connector. Use wire crimpers to crimp the butt connector on the harness to the Up-fitter wire, White/Orange, located near the passenger side rear door on the side of the trunk. Slide the heat shrink over the butt connector and use heat gun to secure.



16. Use wire crimpers to crimp (1) butt connector to the Up-fitter wire located under the passenger side of the dash board, it is a White/Orange wire. Crimp the other side of the butt connector to the White/Brown wire. This White/Brown wire is an Up-fitter wire from under the dashboard to the engine bay and the other end is found in a bundle of three wires near the brake booster.

17. Test out the lights to ensure that the RTL and the chase lights are operating as expected, the Brake should light up the RTL, when the headlights are on the running light on the RTL should operate, the Brake should increase the RTL brightness when running light is on, Reverse should light up the RTL with white light. Troubleshoot if needed.
18. Use zip ties to secure the wiring harness in place and it is recommended to leave slack inside of the tailgate.



19. Replace all the interior panels in the opposite order they were removed.
20. Install is complete enjoy your SDHQ Built Ford Bronco 3rd Brake Light Chase Light Wiring Harness for Baja Designs.



For questions or help with the installation, please email help@sdhqoffroad.com
Store front hours: Mon. – Fri. 8:00am – 5:30pm and Sat. 9:00am – 2:00pm Arizona Time.

*****Double check all hardware is installed correctly and tight*****

*****Re-torque ALL bolts after 100 miles*****



190 S McQueen Rd
Ste 109 Gilbert, AZ 85233
www.sdhqoffroad.com

Follow us on:



Facebook



Instagram

For questions or help with the installation, please email help@sdhqoffroad.com
Store front hours: Mon. – Fri. 8:00am – 5:30pm and Sat. 9:00am – 2:00pm Arizona Time.