



# Inspired by temperature

Betriebsanleitung · Operation manual · Manual de instrucciones · Manuel d'utilisation · Manuale de d'uso · 사용 설명서 · Manual de instruções · Инструкция по эксплуатации · Kullanım talimatı · 操作说明书 · Betriebsanweisung · Manual de instrucciones · Manuel d'utilisation · Manuale de d'uso · 사용 설명서 · Manual de instruções · Инструкция по эксплуатации · Kullanım talimatı · 操作说明书 · Betriebsanweisung · Manual de instrucciones · Manuel d'utilisation · Manuale de d'uso · 사용 설명서 · Manual de instruções · Инструкция по эксплуатации · Kullanım talimatı · 操作说明书

## KISS® Cooling Baths

**This documentation does not contain a device-specific technical appendix.**

You can request the full operating instructions from [info@huber-online.com](mailto:info@huber-online.com). Please give the model designation and serial number of your temperature control unit in your e-mail.

**huber**





OPERATION MANUAL

# **KISS<sup>®</sup> Cooling Baths**



# Cooling baths

KISS®

This operation manual is a translation of the original operation manual.

## VALID FOR:

K6

K1x

K2x

KISS® K6

KISS® K1x

KISS® K2x

Abbreviations used in model name:

s = stronger cooling capacity

The control panel:  
Displays and keys

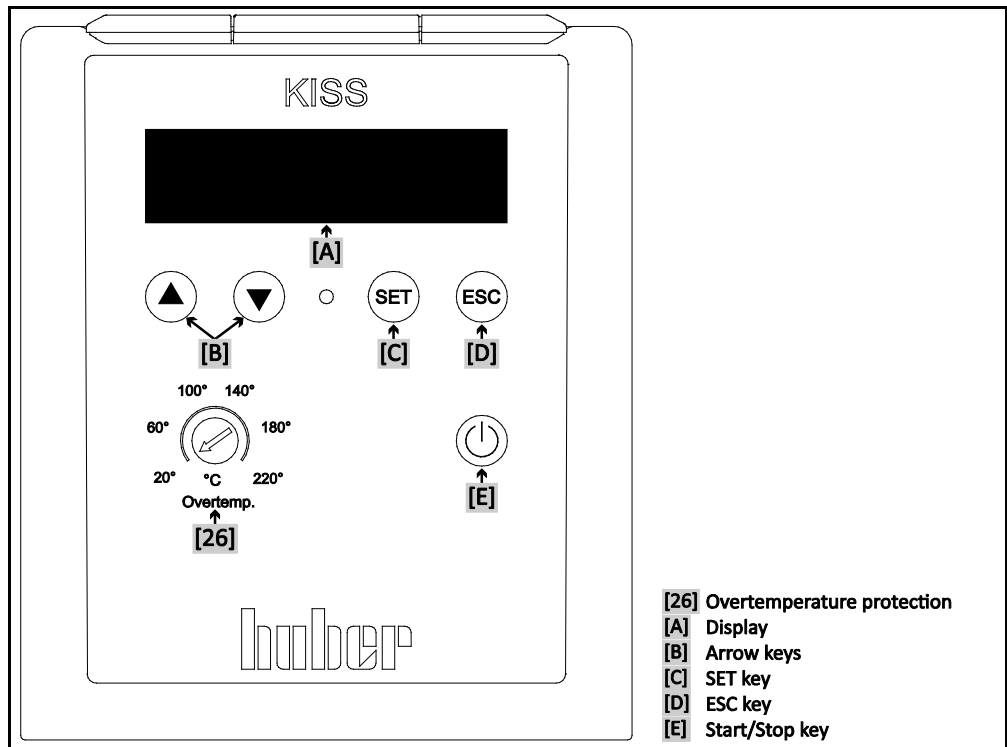

Connections: K6, K1x  
and K2x (from left to  
right)

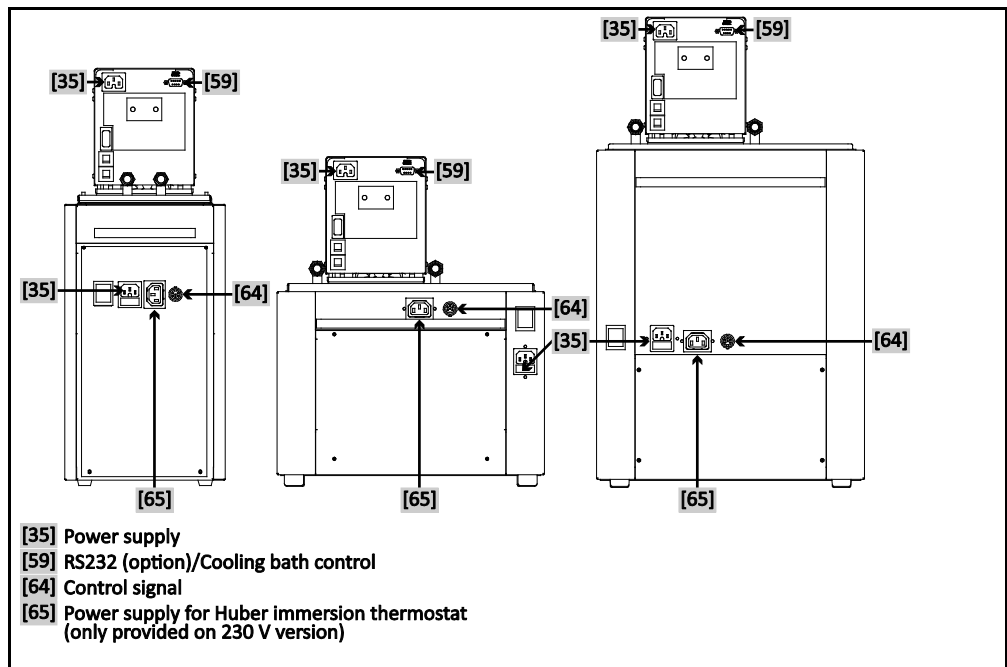

# Table of contents

V1.2.0en/04.02.19//0.3.1

<b>1</b>	<b>Introduction</b>	<b>12</b>
<b>1.1</b>	<b>Details on the declaration of conformity.....</b>	<b>12</b>
<b>1.2</b>	<b>Safety .....</b>	<b>12</b>
1.2.1	Symbols used for Safety Instructions.....	12
1.2.2	Representation of safety identifiers .....	13
1.2.3	Proper operation.....	13
1.2.4	Reasonably foreseeable misuse.....	14
<b>1.3</b>	<b>Responsible bodies and operators – Obligations and requirements.....</b>	<b>14</b>
1.3.1	Obligations of the responsible body .....	14
1.3.1.1	Proper disposal of resources and consumables .....	15
1.3.1.2	Temperature control unit with natural refrigerants (NR) .....	15
1.3.2	Requirements for operators .....	16
1.3.3	Obligations of the operators.....	16
<b>1.4</b>	<b>General information.....</b>	<b>16</b>
1.4.1	Description of workstation .....	16
1.4.2	Safety devices to DIN 12876 .....	16
1.4.3	Further protective devices .....	17
1.4.3.1	Power interruption .....	17
<b>2</b>	<b>Commissioning</b>	<b>18</b>
<b>2.1</b>	<b>In-plant transport.....</b>	<b>18</b>
2.1.1	Lifting and transporting the temperature control unit.....	18
2.1.2	Positioning the temperature control unit.....	18
<b>2.2</b>	<b>Unpacking .....</b>	<b>18</b>
<b>2.3</b>	<b>Ambient conditions.....</b>	<b>18</b>
2.3.1	EMC-specific notes.....	20
<b>2.4</b>	<b>Installation conditions.....</b>	<b>20</b>
<b>2.5</b>	<b>Recommended temperature control and cooling water hoses .....</b>	<b>20</b>
<b>2.6</b>	<b>Wrench sizes and torques.....</b>	<b>21</b>
<b>2.7</b>	<b>Temperature control unit with batch.....</b>	<b>21</b>
2.7.1	Operation as bath thermostat .....	21
<b>2.8</b>	<b>Preparations for operation .....</b>	<b>21</b>
2.8.1	Externally closed and externally open applications.....	21
2.8.2	Cooling/heating baths: Connect the energizing lead.....	22
<b>2.9</b>	<b>Connecting externally closed application .....</b>	<b>22</b>
2.9.1	Connecting an externally closed application .....	22
<b>2.10</b>	<b>Connecting to the power supply .....</b>	<b>23</b>
2.10.1	Connection using socket with protective earth (PE).....	23
2.10.2	Connection via hard wiring.....	23
2.10.3	Connecting the functional earth.....	24
2.10.4	Cooling/heating baths: Connecting to the power supply .....	24
2.10.4.1	Utilization as a pure cooling bath (without hanger thermostat).....	24
2.10.4.2	Utilization as a cooling/heating baths (with hanger thermostat) .....	24
<b>3</b>	<b>Function description</b>	<b>26</b>
<b>3.1</b>	<b>Function description of the temperature control unit .....</b>	<b>26</b>
3.1.1	General functions.....	26

3.1.2	Other functions .....	26
<b>3.2</b>	<b>Information on the thermal fluids .....</b>	<b>26</b>
<b>3.3</b>	<b>To be noted when planning the test .....</b>	<b>28</b>
<b>3.4</b>	<b>Display and control instruments .....</b>	<b>29</b>
3.4.1	Display .....	29
3.4.2	Control instruments .....	30
3.4.2.1	Arrow keys .....	30
3.4.2.2	SET key .....	30
3.4.2.3	ESC key .....	30
3.4.2.4	Start/Stop key .....	31
3.4.3	Adjusting settings .....	31
<b>3.5</b>	<b>Menu function .....</b>	<b>32</b>
<b>3.6</b>	<b>Functional examples .....</b>	<b>33</b>
3.6.1	Selecting a language .....	33
3.6.2	Switching the cooling bath controller on/off .....	33
3.6.3	Setting the setpoint .....	33
3.6.4	Changing the Auto-Start function .....	33
<b>4</b>	<b>Setup mode .....</b>	<b>34</b>
<b>4.1</b>	<b>Setup mode .....</b>	<b>34</b>
4.1.1	Turning on the temperature control unit .....	34
4.1.2	Turning off the temperature control unit .....	34
4.1.3	Cooling/heating baths: Power On/Off .....	34
4.1.3.1	Cooling/heating baths: Switching on (without an immersion circulator thermostat) .....	34
4.1.3.2	Cooling/heating baths: Switching off (without an immersion circulator thermostat) .....	34
4.1.3.3	Cooling/heating baths: Switching on (with an immersion circulator thermostat) .....	35
4.1.3.4	Cooling/heating baths: Switching off (with an immersion circulator thermostat) .....	35
4.1.4	Setting the overtemperature (OT) protection .....	35
4.1.4.1	General information on the overtemperature protection .....	35
4.1.4.2	Setting the overtemperature protection .....	36
4.1.5	Testing overtemperature protection for functionality .....	36
<b>4.2</b>	<b>Filling, venting, degassing and draining .....</b>	<b>37</b>
4.2.1	Filling, venting, degassing and draining the bath thermostat .....	37
4.2.1.1	Filling and venting the bath thermostat and the externally closed application .....	37
4.2.1.2	Degassing of bath thermostat .....	38
4.2.1.3	Draining the bath thermostat .....	38
<b>5</b>	<b>Normal operation .....</b>	<b>40</b>
<b>5.1</b>	<b>Automatic operation .....</b>	<b>40</b>
5.1.1	Temperature control .....	40
5.1.1.1	Starting the temperature control process .....	40
5.1.1.2	Ending the temperature control process .....	40
<b>5.2</b>	<b>Cooling/heating baths: Automatic operation (without an immersion circulator thermostat) .....</b>	<b>41</b>
5.2.1	Cooling/heating baths: Temperature control .....	41
5.2.1.1	Cooling/heating baths: Starting the temperature control process .....	41
5.2.1.2	Cooling/heating baths: Ending the temperature control process .....	41
<b>6</b>	<b>Interfaces and data communication .....</b>	<b>42</b>



<b>6.1</b>	<b>Controller interfaces .....</b>	<b>42</b>
6.1.1	USB-2.0 interface .....	42
6.1.1.1	USB-2.0 interface, device .....	42
6.1.2	RS232 jack .....	42
6.1.3	Pt100 process display sensor port (option) .....	42
<b>6.2</b>	<b>Cooling/heating baths: Interfaces at the back .....</b>	<b>43</b>
6.2.1	Activation connector .....	43
<b>6.3</b>	<b>Cooling/heating baths: Interfaces on the hanger thermostat .....</b>	<b>43</b>
6.3.1	RS232 jack .....	43
<b>6.4</b>	<b>Data communication .....</b>	<b>44</b>
6.4.1	LAI commands .....	44
6.4.1.1	Command "V" (Verify) .....	45
6.4.1.2	Command "L" (Limit) .....	45
6.4.1.3	Command "G" (General) .....	46
6.4.2	PP commands .....	48
<b>7</b>	<b>Service/maintenance .....</b>	<b>49</b>
<b>7.1</b>	<b>Displays in the event of faults .....</b>	<b>49</b>
<b>7.2</b>	<b>Electrical fuse .....</b>	<b>50</b>
<b>7.3</b>	<b>Maintenance .....</b>	<b>50</b>
7.3.1	Function check and visual inspection .....	51
7.3.2	Replacing temperature control hoses .....	51
7.3.3	Clean liquefier fins (air-cooled temperature control unit) .....	52
<b>7.4</b>	<b>Thermal fluid inspection, replacement and circuit cleaning .....</b>	<b>53</b>
7.4.1	Thermal fluid inspection .....	53
7.4.2	Rinsing the thermal fluid circuit .....	53
<b>7.5</b>	<b>Cleaning the surfaces .....</b>	<b>55</b>
<b>7.6</b>	<b>Plug contacts .....</b>	<b>55</b>
<b>7.7</b>	<b>Decontamination/repairs .....</b>	<b>55</b>
<b>8</b>	<b>Shutting down .....</b>	<b>56</b>
<b>8.1</b>	<b>Safety instructions and basic principles .....</b>	<b>56</b>
<b>8.2</b>	<b>Switch-off .....</b>	<b>56</b>
<b>8.3</b>	<b>Draining the cooling water .....</b>	<b>57</b>
8.3.1	Draining process .....	57
<b>8.4</b>	<b>Packing .....</b>	<b>57</b>
<b>8.5</b>	<b>Shipping .....</b>	<b>57</b>
<b>8.6</b>	<b>Disposal .....</b>	<b>58</b>
<b>8.7</b>	<b>Phone number and company address .....</b>	<b>58</b>
8.7.1	Telephone number: Customer Support .....	58
8.7.2	Telephone number: Sales .....	58
8.7.3	Email address: Customer Support .....	58
8.7.4	Service/return address .....	58
<b>8.8</b>	<b>Certificate of Compliance .....</b>	<b>59</b>
<b>9</b>	<b>Annex .....</b>	<b>60</b>



## Foreword

Dear Customer,

Thank you for choosing a temperature control unit from Peter Huber Kältemaschinenbau AG. You have made a good choice. Thank you for your trust.

Please read the operation manual carefully before putting the unit into operation. Strictly follow all notes and safety instructions.

Follow the operation manual with regard to transport, start-up, operation, maintenance, repair, storage and disposal of the temperature control unit.

We fully warrant the temperature control unit for the specified normal operation.

The models listed on page 5 are referred to in this operation manual as temperature control units and Peter Huber Kältemaschinenbau AG as Huber company or Huber.

Liability for errors and misprints excluded.

The following trademarks and the Huber logo are registered trademarks of Peter Huber Kältemaschinenbau AG in Germany and/or other countries worldwide: BFT®, CC®, CC-Pilot®, Com.G@te®, Compatible Control®, CoolNet®, DC®, E-grade®, Grande Fleur®, KISS®, Minichiller®, Ministat®, MP®, MPC®, Peter Huber Minichiller®, Petite Fleur®, Pilot ONE®, RotaCool®, Rotostat®, SpyControl®, SpyLight®, Tango®, TC®, UC®, Unical®, Unichiller®, Unipump®, Unistat®, Unistat-Pilot®, Unistat Tango®, Variostat®, Web.G@te®. The following trademarks are registered in Germany to DWS Synthesetechnik: DW-Therm®, DW-Therm HT®

# 1 Introduction

## 1.1 Details on the declaration of conformity

**CE** The equipment complies with the basic health and safety requirements of the European Directives listed below:

- Machinery Directive
- Low Voltage Directive
- EMC Directive

## 1.2 Safety

### 1.2.1 Symbols used for Safety Instructions

Safety instructions are marked by the below combinations of pictograms and signal words. The signal word describes the classification of the residual risk when disregarding the operation manual.



Denotes an immediate hazardous situation that will result in death or serious injuries.



Denotes a general hazardous situation that may result in death or serious injuries.



Denotes a hazardous situation that can result in injury.



Denotes a situation that can result in property material damage.



Denotes important notes and usable hints.



Notes in conjunction with Ex p cabinets.



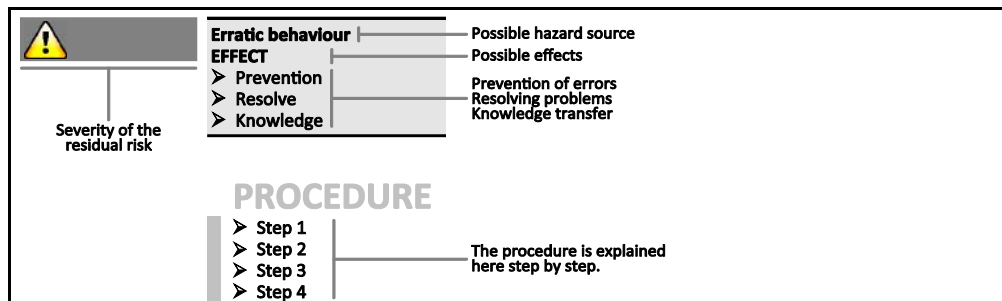

Safety information and procedure



The safety information in this operation manual is designed to protect the responsible body, the operator and the equipment from damage. Safety instructions appear at the beginning of each chapter and before instructions. First inform yourself about any residual risks due to misuse before you start an operation.

## 1.2.2 Representation of safety identifiers

The following pictograms are used as safety identifiers. The table gives an overview of the safety identifier used here.

Identifier	Description
<b>Mandatory sign</b>	
	- Observe the instructions
<b>Warning sign</b>	
	- General warning sign - observe the instructions
	- Warning of electrical voltage
	- Warning of hot surface
	- Warning of flammable substances

## 1.2.3 Proper operation



**DANGER**

**Operating the temperature control unit in a potentially explosive area**

**DEATH THROUGH EXPLOSION**

- Do NOT install or start up the temperature control unit within an ATEX zone.



**WARNING**

**Improper use**

**SERIOUS INJURY AND PROPERTY DAMAGE**

- Store the operation manual where it is easy to access in close proximity to the temperature control unit.
- Only adequately qualified operators may work with the temperature control unit.
- Operators must be trained before handling the temperature control unit.
- Check that the operators have read and understood the operation manual.
- Define precise responsibilities of the operators.
- Personal protective equipment must be provided to the operators.
- Be sure to follow the responsible body's safety rules to protect life and limb and to limit damages!

**NOTE**

**Modifications to the temperature control unit by third-parties**

**DAMAGE TO THE TEMPERATURE CONTROL UNIT**

- Do not allow third parties to make technical modifications to the temperature control unit.
- The EU declaration of conformity becomes invalid if any modifications are made to the temperature control unit without the approval of Huber.
- Only specialists trained by Huber may carry out modifications, repairs or maintenance work.
- **The following must be observed without fail:**
- Only use the temperature control unit in a fault-free condition!
- Have the start-up and repairs carried out by specialists only!
- Do not ignore, bypass, dismantle or disconnect any safety devices!

The temperature control unit must not be used for any purposes other than temperature control in accordance with the operation manual.

The temperature control unit is manufactured for industrial use. The temperature control unit maintains the temperature of certain applications, including glass or metal reactors or other expedient items in laboratories and industry. Flow-through coolers and calibration baths must be used only in combination with Huber temperature control units. Thermal fluids suitable for the overall system are used. The chilling and heating capacity is provisioned at the pump connections or - where present - in the tempering bath. The technical specification of the temperature control unit is given in the data sheet (from page 60 in section »Annex«). The temperature control unit must be installed, configured and operated according to the handling instructions in this operating manual. Failure to comply with the operation manual is deemed improper use. The temperature control unit conforms to state-of-the-art technology and the recognized safety regulations. Safety devices are built into your temperature control unit.

#### 1.2.4 Reasonably foreseeable misuse



Without an Ex p cabinet, the temperature control unit is **NOT** protected against explosion and must **NOT** be installed or put into operation within an ATEX Zone. When operating the temperature control unit in conjunction with an Ex p cabinet, the information in the annex (Section ATEX operation) must be observed and followed. This annex is only provided for temperature control units delivered with an Ex p cabinet. If this annex is missing, please immediately contact the Customer Support of Huber (the telephone number is provided on page 58 in Section »Phone number and company address«).

Use with medical devices (e.g. in Vitro diagnostic procedure) or for direct foodstuff temperature control is **NOT** permissible.

The temperature control unit must **NOT** be used for any purposes other than temperature control in accordance with the operation manual.

The manufacturer accepts **NO** liability for damage caused by **technical modifications** to the temperature control unit, **improper handling** or use of the temperature control unit if the operation manual is **not observed**.

### 1.3 Responsible bodies and operators – Obligations and requirements

#### 1.3.1 Obligations of the responsible body

The operation manual is to be stored where it is easy to access in close proximity to the temperature control unit. Only adequately qualified operators (e.g. chemists, CTA, physicists etc.) are permitted to work with the temperature control unit. Operators must be trained before handling the temperature control unit. Check that the operators have read and understood the operation manual. Define precise responsibilities of the operators. Personal protective equipment must be provided to the operators.

- The responsible body must install a condensation water / thermal fluid drip tray below the temperature control unit.
- The responsible body must check whether national regulations require the mandatory installation of a drain tray for the installation area of the temperature control unit/the entire system.
- Our temperature control unit complies with all applicable safety standards.
- Your system, which uses our temperature control unit, must be as safe.
- The responsible body must design the system to ensure it is safe.
- Huber is not responsible for the safety of your system. The responsible body is responsible for the safety of the system.

- Although the temperature control unit provided by Huber meets all the applicable safety standards, integration into a system may give rise to hazards that are characteristic of the other system's design and beyond the control of Huber.
- It is the responsibility of the system integrator to ensure that the overall system, into which this temperature control unit is integrated, is safe.
- The >Mains isolator< [36] (if present) may be provided with a facility to lock the main isolator in the off position to facilitate safe system installation and maintenance of the temperature control unit. It is the responsibility of the responsible body to develop any lock-out/tag-out procedure in accordance with local regulations (e.g. CFR 1910.147 for the US).

### 1.3.1.1 Proper disposal of resources and consumables

Do comply with all national disposal regulations applicable for you. Contact your local waste management company for any questions concerning disposal.

Overview	Material / Aids	Disposal / Cleaning
	Packing material	Keep the packaging material for future use (e.g. transport).
	Thermal fluid	Please refer to the safety data sheet of the thermal fluid used for information on its proper disposal. Use the original thermal fluid container when disposing it.
	Filling accessories, e.g. beaker	Clean the filling accessories for reuse. Make sure that the materials and cleaning agents used are properly disposed of.
	Aids such as towels, cleaning cloths	Tools used to take up spilled thermal fluid must be disposed of in the same fashion as the thermal fluid itself. Tools used for cleaning must be disposed of depending on the cleaning agent used.
	Cleaning agents such as stainless steel cleaning agents, sensitive-fabrics detergents	Please refer to the safety data sheet of the cleaning agent used for information on its proper disposal. Use the original containers when disposing of large quantities of cleaning agents.
	Consumables such as air filter mats, temperature control hoses	Please refer to the safety data sheet of the consumables used for information on their proper disposal.

### 1.3.1.2 Temperature control unit with natural refrigerants (NR)



**WARNING**

**Over 8 g refrigerant per m<sup>3</sup> room air**

**DEATH OR SERIOUS INJURY DUE TO EXPLOSION**

- Observe the rating plate (amount of natural refrigerant contained) and the room size (maximum room concentration of natural refrigerant in case of leakage) when installing the temperature control unit.
- Over 8 g refrigerant per m<sup>3</sup> room air: A gas warning sensor must be fitted and functioning.
- The gas warning sensor must be calibrated and maintained at regular intervals (between 6 and 12 months).
- The temperature control unit is not approved for operation **in an ATEX zone**.

Huber products with natural refrigerants work with numerous proven, safe and highly-sustainable technologies. The relevant standards and regulations for temperature control units with natural refrigerants contain a number of stipulations, the importance of complying with which is set out below. Also observe on page 13 the section »**Proper operation**«.

Huber temperature control units are constructed to be permanently sealed and are carefully checked for leak tightness. Temperature control units with more than 150 g natural refrigerant are equipped with an additional gas warning sensor. To find out whether your temperature control unit is equipped with a gas warning sensor, refer to the data sheet from page 60 in section »**Annex**«.

The fill quantity of your temperature control unit is stated on the data sheet (from page 60 in section »**Annex**«) or on the rating plate on the rear of the temperature control unit. Observe page 18, section »**Ambient conditions**« and page 20, section »**Installation conditions**«.

Classifying the application field

Class of application field	Application field	Example of the installation location	Max. quantity of refrigerant	AND	Max. permissible quantity above ground level (GL)
A	General	Publicly accessible area in a public building	8 g/m <sup>3</sup> ambient air		1.5 kg
B	Monitored	Laboratories			2.5 kg
C	Access only for authorized persons	Production equipment			10.0 kg
Temperature control units with <b>more than 1 kg</b> refrigerant <b>must not be installed below ground level (GL)</b> .					

**Temperature control units with up to 150 g natural refrigerant**

- The temperature control unit has been constructed to the requirements of EU and EFTA countries.
- Use the table as guidance for classifying the application field. Respect the max. refrigerant quantity stated therein.

### 1.3.2 Requirements for operators

Work on the temperature control unit is reserved for appropriately qualified specialists, who have been assigned and trained by the responsible body to do so. Operators must be at least 18 years old. Under 18-year olds may operate the temperature control unit only under the supervision of a qualified specialist. The operator is responsible vis-a-vis third-parties in the work area.

### 1.3.3 Obligations of the operators

Carefully read the operation manual before operating the temperature control unit. Please observe the safety instructions. When operating the temperature control unit, wear appropriate personal protective equipment (e.g. safety goggles, protective gloves, non-slip shoes).

## 1.4 General information

### 1.4.1 Description of workstation

The workstation is located at the control panel in front of the temperature control unit. The workstation is determined by the customer's connected peripheries. Accordingly, it must be designed safe by the responsible body. The workstation design also depends on the applicable requirements of the German occupational health and safety regulations [BetrSichV] and the risk analysis for the workstation.

### 1.4.2 Safety devices to DIN 12876

The rating of your temperature control unit is stated on the data sheet in the appendix.

Rating of laboratory thermostats and laboratory baths

Classification	Temperature control medium	Technical requirements	Identification <sup>d)</sup>
I	Non-combustible <sup>a)</sup>	Overheat protection <sup>c)</sup>	NFL
II	Combustible <sup>b)</sup>	Adjustable overheat protection	FL
III	Combustible <sup>b)</sup>	Adjustable overtemperature protection and additional low-level protection	FL
<sup>a)</sup> Usually water; other fluids only if non-combustible even within the temperature range of an individual fault. <sup>b)</sup> The temperature control media must have a combustion point of ≥ 65 °C. <sup>c)</sup> The overheat protection can, for instance, can be realized using a suitable fill level sensor or a suitable temperature limiter. <sup>d)</sup> Optional at the choice of the manufacturer.			



Overview of the temperature thresholds

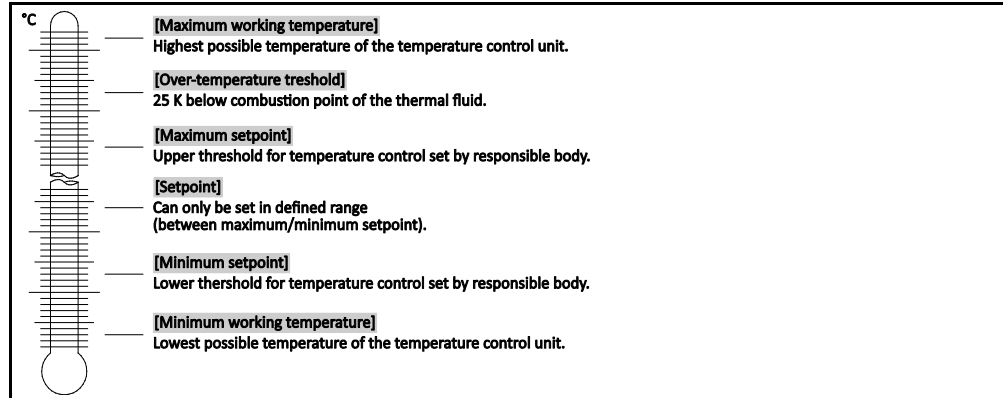

### Mechanical overtemperature protection

Only temperature control units with a heater are fitted with a mechanical overtemperature protection. Set the overtemperature protection as described on page 35 in section »**Setting the overtemperature (OT) protection**«.

### Low level protection

A mechanical float is used for level monitoring. In the bath vessel, a floating body, which is guided in a device, floats on the surface of the thermal fluid. Depending on the level of the thermal fluid, the float device signals the electronics a **state of good** (in case of sufficient filling) or a **state of bad** (in case of insufficient filling). The functionality of the float switch is checked at regular intervals during continuous operation.

## 1.4.3 Further protective devices

### INFORMATION

Emergency strategy – isolate the power supply!

To determine the type of switch or switch combination your temperature control unit is equipped with, please refer to the connection sketch starting on page 60 in the section »**Annex**«.

**Temperature control units with >Mains isolator< [36] (red/yellow or gray):** Turn the >Mains isolator< [36] to the "0" position!

**Temperature control units with >Mains isolator< [36] (red/yellow) and additional >Appliance switch< [37] (gray):** Turn the >Mains isolator< [36] to the "0" position! Then turn the >Appliance switch< [37] to the "0" position!

**Temperature control units with >Mains isolator< [36] (gray) and >Emergency stop switch< [70] (red/yellow):** Press the >Emergency stop switch< [70]. Then turn the >Mains isolator< [36] to the "0" position!

**Temperature control units with >Mains switch< [37]:** Power supply via socket: Disconnect the temperature control unit from the power supply. Then turn the >Mains isolator< [37] to the "0" position! Power supply via hard wiring: Disconnect the power supply by means of the building's circuit breaker. Then turn the >Mains isolator< [37] to the "0" position!

**Temperature control units without a switch or inside a protective housing:** Connection via socket: Disconnect the temperature control unit from the power supply. Connection via hard wiring: Disconnect the power supply by means of the building's circuit breaker.

### 1.4.3.1 Power interruption

Following a power outage (or when switching on the temperature control unit), this function can be used to determine how the temperature control unit is supposed to respond.

#### Auto-Start function is turned off

The temperature control is started only by manual input when the temperature control unit is turned on.

#### Auto-Start function is turned on

The temperature control unit is set to the same state it was in before the power outage. For example, before the power outage: Thermoregulation is off; after power outage: Thermoregulation is off. If temperature control is active during a power outage, the process will automatically continue after the power outage.

Further information can be found on page 33 in section »**Changing the Auto-Start function**«.

## 2 Commissioning

### 2.1 In-plant transport

**NOTE**

Temperature control unit transported in a horizontal position

**DAMAGE TO THE COMPRESSOR**

➤ Only transport the temperature control unit in an upright position.

- Use an industrial truck for transport.
- Remove the packing material (e.g. the palette) only at the place of installation.
- Protect the temperature control unit from transport damage.
- Do not transport the temperature control unit alone and without aids.
- Check the load bearing capacity of the transportation route and the place of installation.

#### 2.1.1 Lifting and transporting the temperature control unit

- Do not lift and transport the temperature control unit alone and without aids.
- Lift and transport the temperature control unit only with an industrial truck.
- The industrial truck must have a lifting force equal to or greater than the weight of the temperature control unit. See the data sheet (from page 60 in section »Annex«) for the weight of the temperature control unit.

#### 2.1.2 Positioning the temperature control unit

- An industrial truck must be used for positioning the temperature control unit.
- Do not move the temperature control unit alone.
- **At least 2 persons** are required to move the temperature control unit.
- The industrial truck must have a lifting force equal to or greater than the weight of the temperature control unit. See the data sheet (from page 60 in section »Annex«) for the weight of the temperature control unit.

### 2.2 Unpacking

**WARNING**

Starting up a damaged temperature control unit

**MORTAL DANGER FROM ELECTRIC SHOCK**

- Do not operate a damaged temperature control unit.
- Please contact the Customer Support. The telephone number can be found on page 58, section »Phone number and company address«.

### PROCEDURE

- Check for damage to the packaging. Damage can indicate property damage to the temperature control unit.
- Check for any transport damage when unpacking the temperature control unit.
- Always contact your forwarding agent regarding the settlement of claims.
- Follow the instructions on page 15, section »Proper disposal of resources and consumables« for the disposal of packaging material.

### 2.3 Ambient conditions

**CAUTION**

Unsuitable ambient conditions/unsuitable installation

**SERIOUS INJURY DUE TO CRUSHING**

- Comply with the requirements under sections »Ambient conditions« and »Installation conditions«.

**INFORMATION**

Make sure there is adequate fresh air available at the site for the circulation pump and the compressors. The warm exhaust air must be able to escape upwards unhindered.

**Free-standing model**

For the connection data, see the data sheet (from page 60 in Section »Annex«).

Use of the temperature control unit is permitted only under normal ambient conditions in accordance with DIN EN 61010-1:2011:

- Use only indoors. The illuminance must be at least 300 lx.
- Installation altitude up to 2000 meters above sea level .
- Maintain wall and ceiling clearance for adequate air exchange (dissipation of waste heat, supply of fresh air for the temperature control unit and work area). Ensure adequate floor clearance for air-cooled temperature control units. Do not operate this temperature control unit from within the box or with an inadequately dimensioned bath. This inhibits the exchange of air.
- Ambient temperature values are provided on the technical data sheet; compliance with the ambient conditions is mandatory, to ensure trouble-free operation.
- Relative humidity up to 32 °C max. 80% and decreasing linearly to 50% up to 40 °C.
- Short distance to supply connections.
- The temperature control unit must not be installed so as to hinder or prevent access to the isolator (to the power supply).
- Magnitude of the power supply fluctuations: see data sheet from page 60 in section »Annex«.
- Transient surges, as would normally occur in the power supply system
- Installation Class 3
- Applicable degree of soiling: 2.
- Surge category II.

Wall clearances

Distance in cm	
Side	
[A1] Top	free standing
[B] Left	min. 20
[C] Right	min. 20
[D] Front	min. 20
[E] Rear	min. 20
Distance in cm (for operation in a tub)	
Side	
[A1] Top	free standing
[B] Left	min. 20
[C] Right	min. 20
[D] Front	min. 20
[E] Rear	min. 20

### 2.3.1 EMC-specific notes

These devices are suitable for the operation in “**industrial electromagnetic environments**”. It meets the “**immunity requirements**” of the currently applicable **EN61326-1**, which are required for this environment.

It also meets the “**interference emission requirements**” for this environment. It is a **Group 1** and **Class A** unit according to the currently applicable **EN55011**.

**Group 1** specifies that high frequency (HF) is only used for the function of a device. **Class A** specifies the interference emission limits to be observed.

## 2.4 Installation conditions



**WARNING**

**Temperature control unit is connected to the power supply line  
DEATH FROM ELECTRICAL SHOCK BY DAMAGE TO THE POWER CABLE.**

➤ Do not put temperature control unit on power cable.

- Allow the temperature control unit to acclimate for about 2 hours when changing from a cold to a warm environment (or vice versa). Do not turn on the temperature control unit before!
- Install upright, stable and without tilt.
- Use a non-combustible, sealed subsurface.
- Keep environment clean: Prevent slip and trip hazards.
- Wheels must be locked after the installation, if installed!
- Spilled/leaked thermofluid must be disposed of immediately and properly. Follow the instructions on page 15, section »**Proper disposal of resources and consumables**« for the disposal of thermofluid and material.
- Observe the floor load bearing capacity for large units.
- Observe the ambient conditions.

## 2.5 Recommended temperature control and cooling water hoses



**CAUTION**

**Use of unsuitable/defective hoses and/or hose connections**

**INJURIES**

- **Thermal fluid**
- Use appropriate hoses and/or hose connections.
- Check periodically for leaks and the quality of the hose and hose connections and take suitable measures (replace) as required.
- Isolate and protect temperature control hoses against contact/mechanical load.
- **Cooling water**
- Reinforced hoses must be used to satisfy tougher safety requirements.
- Shut off the cooling water supply to the temperature control unit even for shorter downtimes (e.g. overnight).



**CAUTION**

**Hot or cold thermal fluid and surfaces**

**BURNS TO LIMBS**

- Avoid direct contact with the thermal fluids or the surfaces.
- Wear your personnel protective equipment (e.g. temperature-resistant safety gloves, safety goggles, safety footwear).

To connect applications, use only temperature control hoses that are compatible with the thermal fluid used. When selecting temperature control hoses, also pay attention to the temperature range in which the hoses are to be used.

- We recommend you use only temperature-insulated temperature control hoses with your temperature control unit. The responsible body is responsible for the insulation of connection valves.
- We **exclusively** recommend reinforced hoses for connecting to the cooling water supply. Cooling water and insulated temperature control hoses can be found in the Huber catalogue under Accessories.

## 2.6 Wrench sizes and torques

Note the wrench sizes that result for the pump connection on the temperature control unit. The following table lists the pump connections and the resulting wrench sizes, and torque values. A leak test must always be performed, and the connections tightened if necessary. The values of the maximum torque (see table) must **not** be exceeded.

Overview  
wrench sizes and  
torques

Connection	Sleeve nut wrench size	Connector wrench size	Recommended torques in Nm	Maximum torques in Nm
M16x1	19	17	20	24
M24x1.5	27	27	47	56
M30x1.5	36	32	79	93
	36	36	79	93
M38x1.5	46	46	130	153
G-thread (flat-sealing)	Adapt the torque to the material of the flat seal used. First hand-tighten the temperature control hose.  When using adapters, do not overtighten the G-thread on the pump connection when connecting a temperature control hose. When connecting a temperature control hose to the adapter piece, secure the G thread against overwinding.			

## 2.7 Temperature control unit with batch

### 2.7.1 Operation as bath thermostat

Figure bath thermostat



Note the volume displacement caused by a sample (e.g. Erlenmeyer flask). Place your sample into the empty bath. Only then fill in a sufficient amount of temperature control medium. Also note that the level of the temperature control medium drops when you remove the sample. This may cause a safety shutdown (low level protection) during an enabled thermoregulation. Therefore, switch off the temperature control unit beforehand.

## 2.8 Preparations for operation

### 2.8.1 Externally closed and externally open applications

Using a pre-assembled pump adapter that is also available as an accessory, you can also control the temperature of an external application (e.g. reactor or open bath vessel). Externally open applications can run without interference only in conjunction with a DS level stabilizer (accessory). The DS level stabilizer compensates the differences in the pump (pressure capacity and throughput). If not already attached, please install the pump adapter. In an externally open application, please also install the DS level stabilizer on the externally open bath and observe on page 37 the section »Filling and venting the bath thermostat and the externally closed application« as well as the operation manual of the DS level stabilizer.

## 2.8.2 Cooling/heating baths: Connect the energizing lead

Connecting the energizing lead: K6, K1x and K2x (from left to right)

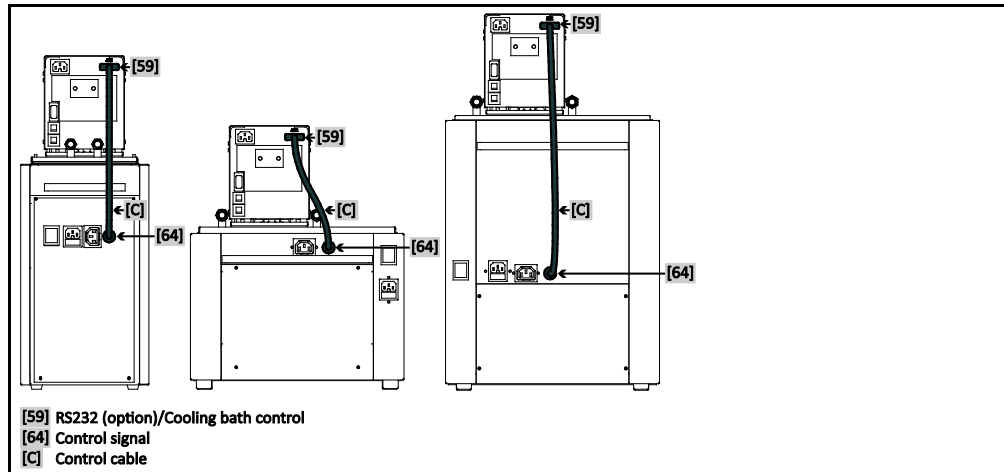

### INFORMATION

The energizing lead must be installed only if the cooling bath is used in **combination** with an immersion circulator thermostat.

## PROCEDURE

- Connect the **>RS232 (option)/activation cooling bath<** [59] port on the hanger thermostat with the **>activation connector<** [64] on the cooling bath. The cable required is included.

## 2.9 Connecting externally closed application

The illustration “connection diagram” can be found on page 60 in section »Annex«.

### 2.9.1 Connecting an externally closed application

#### NOTE

**Overpressure in the application (e.g. > 0.5 bar (g) with glass apparatus)**

#### MATERIAL DAMAGE TO THE APPLICATION

- Provide an overpressure protective device to prevent damage to the application.
- Do not install valves/quick-release couplings in the feed/discharge lines from the temperature control unit to the application and from the application to the temperature control unit.
- **If valves/quick-release couplings are required:**
- Install burst disks on the application itself (at the feed and discharge lines).
- Install a bypass upstream of the valves/quick-release couplings for the application.
- Matching accessories (e.g. bypasses to reduce pressure) can be found in the Huber catalog.

Example: Connecting an externally closed application

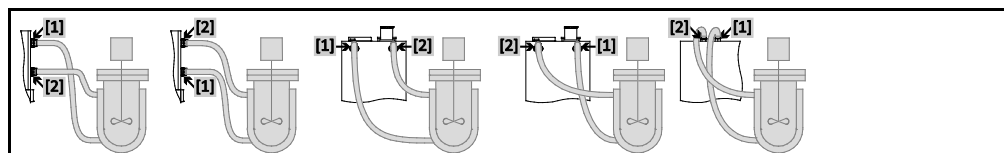

To enable your application to be operated correctly and eliminate air bubbles from the system, you must ensure that the **>Circulation flow<** [1] connection from the temperature control unit is attached to the lower connection point of the application and the **>Circulation return<** [2] into the temperature control unit is attached to the higher connection point of the application.

## PROCEDURE

- Remove the screw plugs from the >Circulation flow< [1] and >Circulation return< [2] connections.
- Then connect your application to the temperature control unit using suitable thermal fluid hoses. The corresponding wrench sizes can be found in the table on page 21 in section »Wrench sizes and torques«.
- Check the connections for leaks.

### 2.10 Connecting to the power supply

#### INFORMATION

Based on local circumstances, it may be that you need to use an alternative power cable instead of the supplied original power cable. Do not use a power cable that is longer than **3 m** to be able to disconnect the temperature control unit at any time from the mains. Have the mains cable only replaced by a qualified electrician.

#### 2.10.1 Connection using socket with protective earth (PE)

##### DANGER

##### Connecting to a power socket without protective earth (PE)

##### MORTAL DANGER FROM ELECTRIC SHOCK

- Always connect the temperature control unit to safety sockets (PE).

##### DANGER

##### Damaged power cable/power cable connection

##### MORTAL DANGER FROM ELECTRIC SHOCK

- Do not start up the temperature control unit.
- Isolate the temperature control unit from the power supply.
- Have the power supply cable/power supply connection replaced and inspected by an electrician.
- Do not use a power cable that is longer than **3 m**.

#### NOTE

##### Incorrect power supply connection

##### DAMAGE TO THE TEMPERATURE CONTROL UNIT

- Your building's existing power supply voltage and frequency must match the data provided on the rating plate of the temperature control unit.

#### INFORMATION

In case of uncertainties about an existing protective earth (PE), have the connection inspected by an electrician.

#### 2.10.2 Connection via hard wiring

##### DANGER

##### Connection/adjustment to the power supply not carried out by an electrician

##### MORTAL DANGER FROM ELECTRIC SHOCK

- Have the connection/adjustment to the power supply carried out by an electrician.

##### DANGER

##### Damaged power cable/power cable connection

##### MORTAL DANGER FROM ELECTRIC SHOCK

- Do not start up the temperature control unit.
- Isolate the temperature control unit from the power supply.
- Have the power supply cable/power supply connection replaced and inspected by an electrician.
- Do not use a power cable that is longer than **3 m**.

#### NOTE

##### Incorrect power supply connection

##### DAMAGE TO THE TEMPERATURE CONTROL UNIT

- Your building's existing power supply voltage and frequency must match the data provided on the rating plate of the temperature control unit.

### 2.10.3 Connecting the functional earth

## PROCEDURE

- If required, connect the temperature control unit's >Functional earth terminal< [87] to the building's grounding point. Use a ground strap for this purpose. For the exact position and thread size please refer to the wiring diagram from page 60 in Section »Annex«.

### 2.10.4 Cooling/heating baths: Connecting to the power supply

#### 2.10.4.1 Utilization as a pure cooling bath (without hanger thermostat)

Installing a mains connection, pure cooling bath (K6, K1x and K2x (from left to right), valid for 100 V, 115 V and 230 V versions)

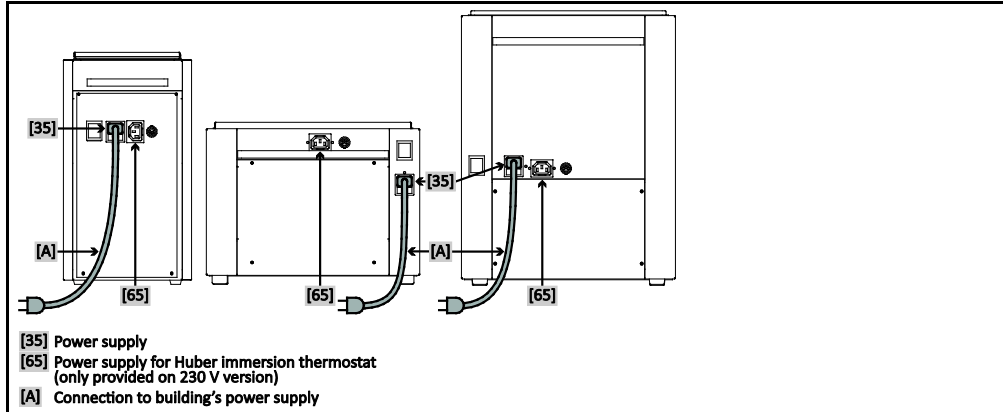

## PROCEDURE

#### Connect the cooling bath to the power supplies (valid for 100 V, 115 V and 230 V versions)

- Connect the >power supply< [35] on the cooling bath with the building's power supply. The cable required is included.

#### 2.10.4.2 Utilization as a cooling/heating baths (with hanger thermostat)

### INFORMATION

There are **two** possibilities for the connection with the building's power supply.

#### 1. Connection with two separate power supplies (valid for 100 V, 115 V and 230 V versions)

The cold bath and the hanger thermostat are **each separately** connected to the building's power supply.

#### 2. Connection with only one power supply (only valid for 230 V version)

Only the cooling bath is connected to the building's power supply, while the hanger thermostat is connected to the cooling bath for a supply of power.

Installing a mains connection, cold bath / heating bath (K6, K1x and K2x (from left to right), valid for 100 V, 115 V and 230 V versions with two power supplies from the building)

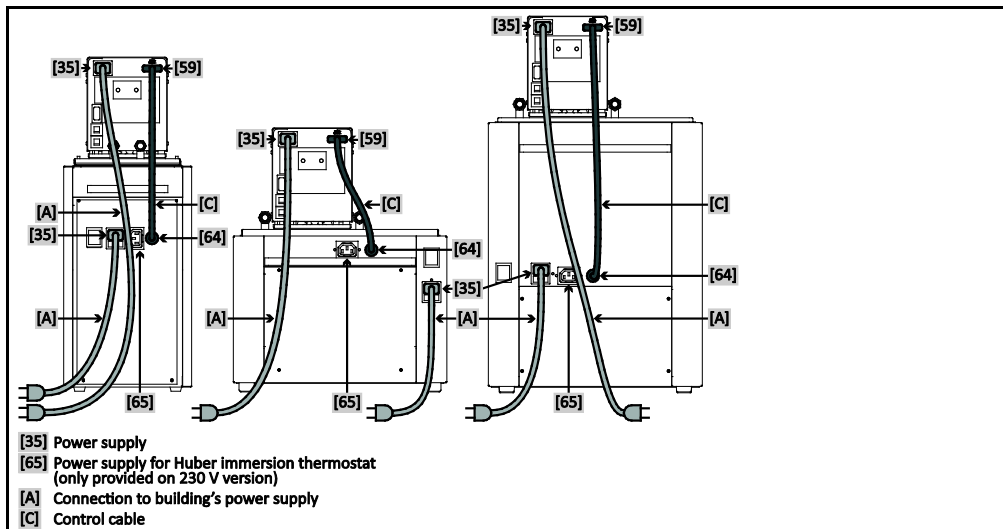



## PROCEDURE

Connect the cooling bath and the hanger thermostat with TWO separate power supplies (valid for 100 V, 115 V and 230 V versions)

- Connect the >power supply< [35] on the hanger thermostat with the building's power supply. The cable required is included.
- Connect the >power supply< [35] on the cooling bath with the building's power supply. The cable required is included.

Installing a mains connection, cold bath / heating bath (K6, K1x and K2x (from left to right), valid for 230 V versions with a single power supply from the building)

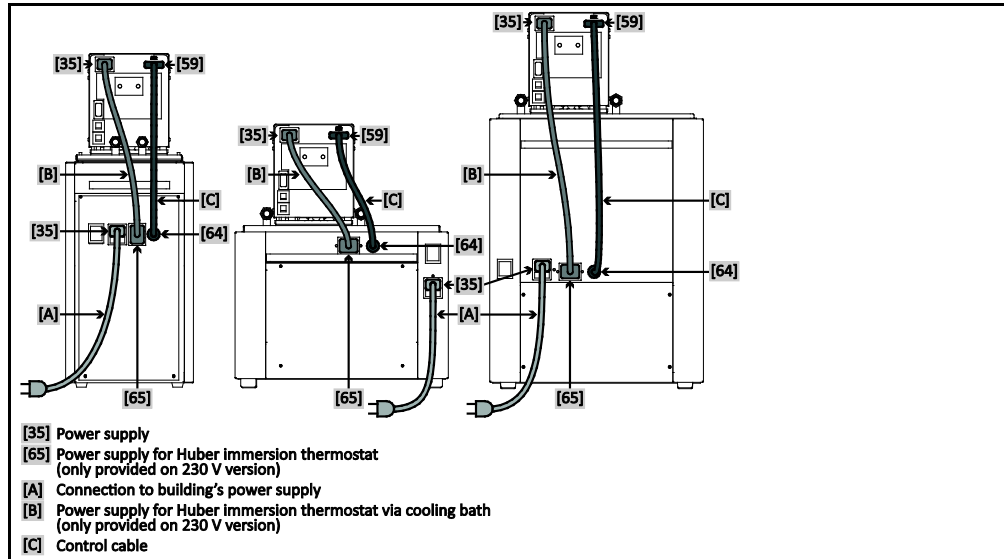

## PROCEDURE

Connection of the cooling bath and the hanger thermostat with ONE power supply (only valid for 230 V version)

- Connect the >power supply< [35] on the hanger thermostat with the >power supply< [65] on the cooling bath. The cable required is included.
- Connect the >power supply< [35] on the cooling bath with the building's power supply. The cable required is included.

## 3 Function description

### 3.1 Function description of the temperature control unit

#### 3.1.1 General functions

This temperature control unit is designed to be used with the **internal bath** as well as **externally closed applications** (see page 22 in Section »Connecting an externally closed application«).

The cooling baths are designed to be used as both **pure cooling baths** as well as **in combination** with an **immersion circulator thermostat** (cooling/heating baths). In combination with an immersion circulator thermostat, the cooling baths may be used across the entire specified temperature range and can cool at the maximum operating temperature in continuous operation too.

#### 3.1.2 Other functions

A pump ensures the thermal fluid is circulated. The following data are displayed on the **display with OLED technology** depending on the model and options: temperature of the internal and external temperature sensor, setpoint. Use the membrane keyboard to enter the controller settings.

The temperature control unit can easily be integrated in many laboratory automation systems using the **standardly existing RS232 and USB interfaces on the controller**.

An external Pt100 sensor can be connected via the optional **Pt100 process display sensor port**. The temperature measured is displayed on the display.

Temperature control units with a heater have an **overtemperature protection to DIN EN 61010-2-010 that is independent** of the control circuit.

## 3.2 Information on the thermal fluids

### CAUTION

**Non-compliance with the safety data sheet for the thermal fluid to be used**

#### INJURIES

- Risk of injury to the eyes, skin, respiratory tract.
- The safety data sheet for the thermal fluid to be used must be read prior to using it and its content must be respected.
- Observe the local regulations/work instructions.
- Wear your personal protective equipment (e.g. temperature-resistant safety gloves, safety goggles, safety footwear).
- Danger of slipping because floor and work area are contaminated. Clean the work station and follow the instructions for the disposal of thermal fluid and material on page 15 in Section »Proper disposal of resources and consumables«.

### NOTE

**Non-compliance with the compatibility between the thermal fluid and your temperature control unit**

#### MATERIAL DAMAGE

- Observe the classification of your temperature control unit according to DIN 12876.
- Ensure the following materials are resistant with respect to the thermal fluid: Stainless steel 1.4301/ 1.4401 (V2A), copper, nickel, FKM, red bronze/brass, silver solder and plastic.
- The maximum viscosity of the thermal fluid must not exceed 50 mm<sup>2</sup>/s at the lowest working temperature!
- The maximum density of the thermal fluid may not exceed 1 kg/dm<sup>3</sup>!

**NOTE**

**Mixing different thermofluids in a thermal fluid circuit**  
**PROPERTY DAMAGE**  
 ➤ Do **not** mix different types of thermofluid (such as mineral oil, silicone oil, synthetic oil, water, etc.) in a thermofluid circuit.  
 ➤ The thermal fluid circuit **must** be rinsed when changing from one type of thermal fluid to another. No residues of the previous type of thermal fluid may remain in the thermal fluid circuit.

Thermal fluid: Water

Designation	Specification
Calcium carbonate per liter	≤ 1.5 mmol/l; corresponds to a water hardness of: ≤ 8.4 °dH (soft)
PH value	between 6.0 and 8.5
Ultrapure water, distillates	Add 0.1 g of sodium carbonate (Na <sub>2</sub> CO <sub>3</sub> ) per liter
Not approved water	Distilled, deionized, demineralized, chloric, ferruginous, ammoniacal, or contaminated river water or sea water
Volume circulated (at least)	3 l/min.
<b>Thermal fluid: Water without ethylene glycol</b>	
Use	≥ +5 °C
<b>Thermal fluid: Water-ethylene glycol mixture</b>	
Use	< +5 °C
Thermal fluid composition	The mixture's temperature must be 10 K below the permissible min. temperature. For the permissible temperature range, refer to the datasheet from page 60 in Section »Annex«.

**INFORMATION**

For thermal fluids we recommend the media listed in the Huber catalog. The name of a thermal fluid is derived from its working temperature range and its viscosity at 25 °C.

Thermal fluid product name/product key

**Thermal fluid product designation/key:**  
 P = plus/M = minus  
 Lowest temperature threshold of the working range  
 Uppermost temperature threshold of the working range  
 Viscosity at 25 °C

**P 20.340.32** = temperature range: +20 ... +340 °C, viscosity at 25 °C: 32 mm<sup>2</sup>/s  
**M80.100.03** = temperature range: -80 ... +100 °C, viscosity at 25 °C: 3 mm<sup>2</sup>/s

Overview:  
 Working temperature ranges of Huber thermofluids

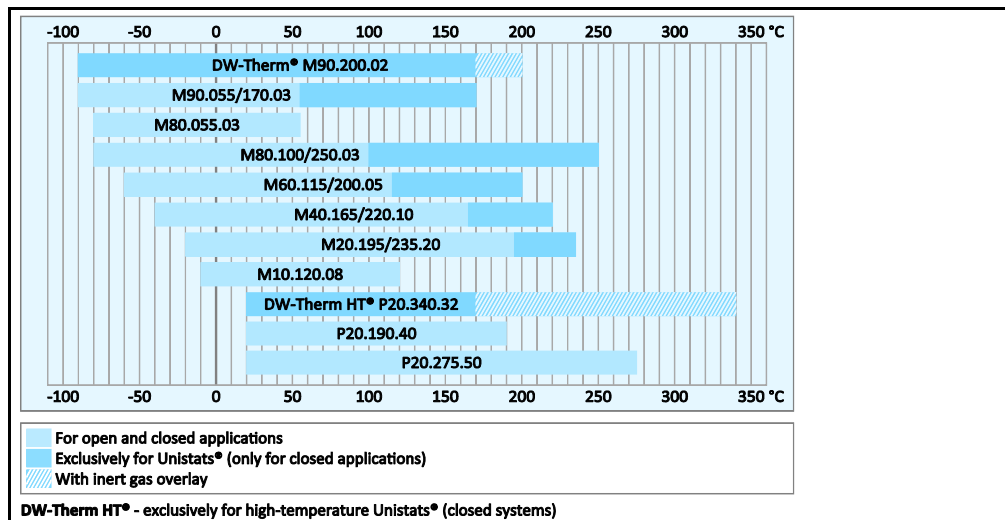

### 3.3 To be noted when planning the test

**INFORMATION**

Also observe page 13 in section »Proper operation«.

The focus is on your application. Bear in mind that system performance is influenced by heat transfer, temperature, thermal fluid viscosity, volume flow, and flow speed.

- Make sure that the electrical connection is adequately dimensioned.
- The installation location of the temperature control unit should be selected so as to ensure adequate fresh air, even with water-cooled chillers.
- The maximum forward flow pressure of a temperature control unit must be taken into account in case of pressure-sensitive applications, such as glass reactors.
- Cross-section reduction or shut-off in the thermal fluid circuit must be avoided. Take corresponding measures to limit the pressure in the system; see data sheet from page 60 in Section »Annex« and the data sheet for your glass apparatus.
- Check whether it is necessary to use an external bypass for temperature control units without pressure limitation.
- In order to prevent the risk of overpressure in the system, the thermal fluid must always be adjusted to room temperature before switching off. This will prevent damage to the temperature control unit or the application. Any isolating valves must remain open (pressure equalization).
- Select the thermal fluid to be used in such a way that it not only permits the minimum and maximum working temperature but is also suitable with regard to combustion point, boiling point, and viscosity. In addition, the thermal fluid must be compatible with all the materials in your system.
- Avoid bending the temperature control and cooling water hoses (if required). Use suitable angle pieces and lay the hose connections with a large radius. Take the minimum bending radius from the data sheet of the temperature control hoses used.
- The selected hose connections must be able to withstand the thermal fluid, the working temperatures and the admissible maximum pressure.
- Check the hoses at regular intervals for any material fatigue (e.g. cracks, leaks).
- Keep the temperature control hoses as short as possible
  - The inside diameters of the temperature control hoses must always be adapted to the pump connections.
  - The viscosity of the thermal fluid determines the pressure drop and influences the temperature control result, especially at low working temperatures.
  - Too small connectors and couplers and valves can generate significant flow resistance. Your application will therefore be slower to reach its design temperature.
- Basically, you should only use the thermal fluids recommended by the manufacturer and only within the usable temperature and pressure range.
- The application should be roughly at the same height of or below the temperature control unit if the thermoregulation is close to the boiling temperature of the thermofluid.
- Fill the temperature control unit slowly, carefully and evenly. Wear the necessary personal protective equipment, such as goggles, heat-proof and chemical-resistant gloves, etc.
- The temperature control circuit must be vented after filling and setting all required parameters. This is required to ensure trouble-free operation of the temperature control unit and hence your application.

**INFORMATION**

For water-cooled temperature control units, please take the cooling water temperature necessary for perfect operation and the required differential pressure from the data sheet from page 60 onward in the Section »Annex«.

### 3.4 Display and control instruments

The control panel:  
Displays and keys

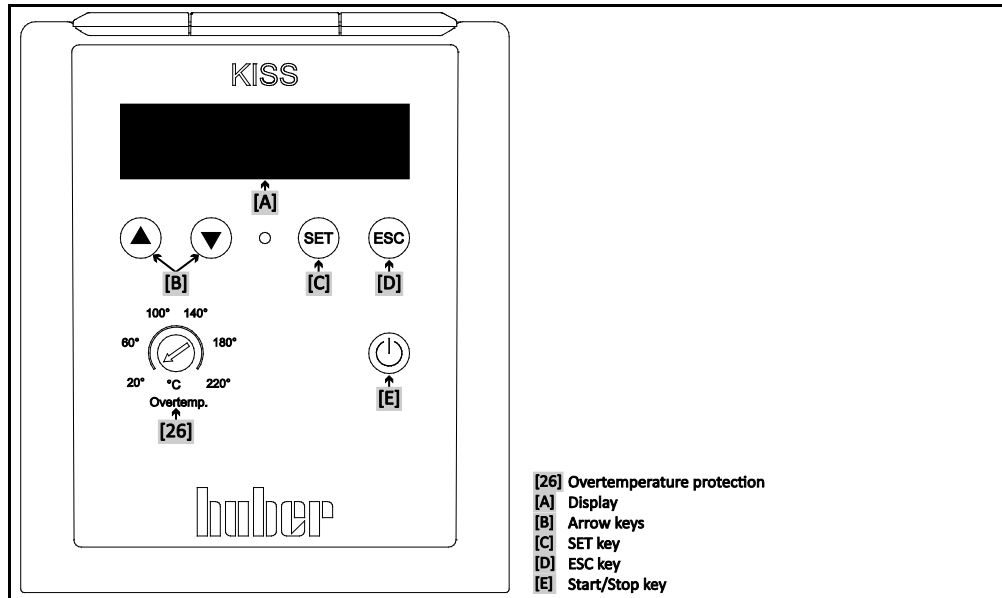

#### 3.4.1 Display

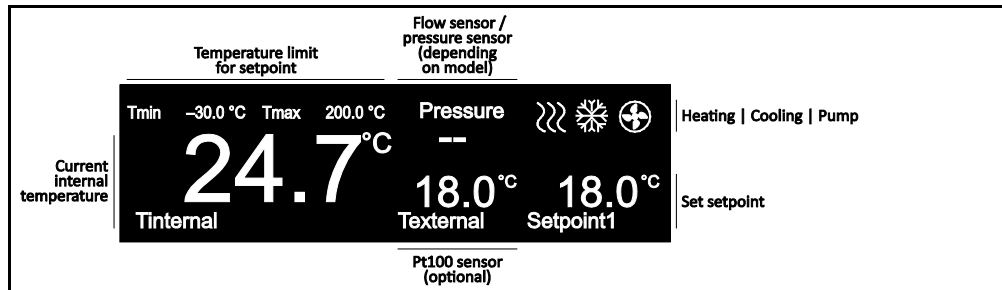

Home screen:  
Temperature control is active

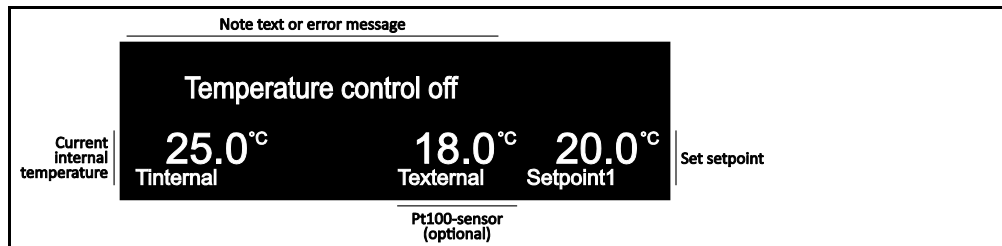

Home screen:  
Temperature control is inactive or an error message is displayed



Home screen:  
Explanation of the  
display

Designation	Description
Temperature limit for setpoint	Display of the setpoint limit. You can set the setpoint only within this range. You can change this limit in the menu item "Protection Options" and then "Setpoint Minimum" and "Setpoint Maximum". Do take the thermal fluid used and the material to be tempered into account when changing these settings. See also on page 32, section »Menu function«.
Flow sensor / pressure sensor (optional, depending on model)	Display for the measured values of the built-in flow or pressure sensor. This feature is optional depending on the model and is not available in KISS controllers and other temperature control units. Use the menu item "Sensor Configuration" under "Flow Sensor / Pressure Sensor Display" to change the display or to turn it on and off. See also on page 32, section »Menu function«.
 Heater	This symbol is displayed when the temperature control unit heats the thermal fluid. (Only for temperature control units with heating)
 Cooling system	This symbol is displayed when the temperature control unit cools down the thermal fluid.
 Pump	The symbol is displayed when the pump in the temperature control unit runs.
Current internal temperature	Display of the current thermal fluid temperature. The temperature is measured and controlled by the internal temperature sensor.
Pt100 sensor (optional)	Displays the measured value of the external Pt100 process display sensor. This display requires that: 1) the temperature control unit is equipped with a Pt100 port, 2) a Pt100 process display sensor has been attached, 3) the Pt100 process display sensor was placed in the application. You can turn on and off the display in the menu item "Sensor Configuration" under "Display external Pt100 sensor" only if the corresponding interface has been installed. See also on page 32, section »Menu function«.
Adjusted setpoint	Displays the setpoint set.
Info text or error message	Displays an info text or error message.

## 3.4.2 Control instruments

### 3.4.2.1 Arrow keys

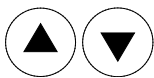

Use the >Arrow keys< [B] to enter values (⊕ (+) or ⊖ (-)), to select a menu item (⊙ (arrow left) or ⊙ (arrow right)) or to select a different menu item (⊕ (up) or ⊖ (down)). Pressing an arrow key for an extended period changes a value faster. Pressing both >Arrow keys< [B] simultaneously calls up the main menu.

### 3.4.2.2 SET key



Pressing the >SET key< [C] on the home screen switches directly to the screen where you can enter the setpoint temperature. It allows you to quickly modify the setpoint temperature. The >SET key< [C] is also used to get to a selected menu item or to confirm changes.

### 3.4.2.3 ESC key



Pressing the >ESC key< [D] cancels changes / entries. The display changes to the previous screen without saving a change / entry. Pressing the >ESC key< [D] brings you back to the previous screen, all the way to the home screen. Press the >ESC key< [D] to acknowledged the alarm sound of an error.

**3.4.2.4 Start/Stop key**

Start or stop the thermoregulation by pressing the >Start/Stop button< [E].

**3.4.3 Adjusting settings**

Exemplary setting of a numerical value



Exemplary setting by text selection

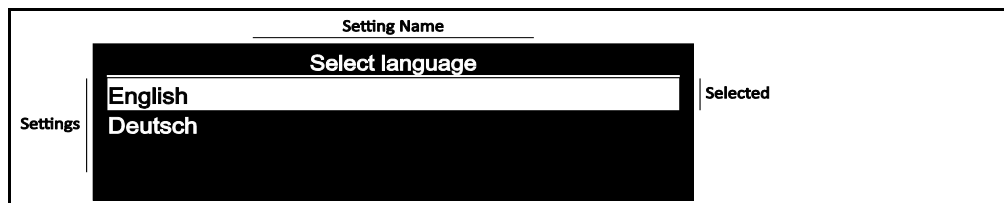

There are two ways to adjust settings:

**Numerical settings:**

Use the >Arrow keys< [B] (⬆ (+) or ⬇ (-)) and confirm an entry by pressing the >SET key< [C]. Pressing an arrow key for an extended period changes a value faster.

**Text selection:**

Select the text via the >Arrow keys< [B] (⬆ (up) or ⬇ (down)) and confirm your entry by pressing the >SET key< [C].





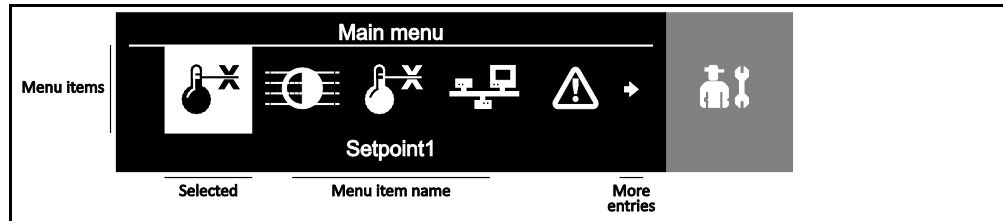

### 3.5 Menu function

Main menu



Pressing both >Arrow keys< [B] simultaneously calls up the main menu. Some menu items cannot be selected depending on the configuration of the temperature control unit.

Overview of the menu items

Display	Description	KISS	OLÉ
 Setpoint 1	Sets the setpoint. Use the >Arrow keys< [B] to change the setpoint.	X	X
 Adjusting brightness	Adjusting the brightness of the OLED display. Use the >Arrow keys< [B] to change the brightness.	X	X
 Sensor configuration	This menu item makes available: 1) Adjustment of the internal sensor (input options: Offset (K)) 2) Adjustment of the external sensor (input options: Offset (K)) 3) Temperature unit (choose between "Celsius" and "Fahrenheit") 4) Mode (choose between "Internal temperature control", "Venting" and "Circulation") 5) Display of external Pt100 sensor – (activating the display of an external Pt100 process display sensor) 6) Flow sensor / pressure sensor display – (activating the display of the optional flow sensor / pressure sensor)	X O X X O –	X O X X O M
 Interfaces	This menu item makes available: 1) RS232 1 (setting of "Baud rate" and "Mode" (HuberBus)) 2) RS232 2 (setting of "Baud rate" and "Mode" (HuberBus)) 3) USB device (setting of "Baud rate" and "Mode" (HuberBus)) <b>Only the Huber service engineer is allowed to use the "STBus" mode.</b> 4) Floating contact (selection of "Off", "Alarm" and "Unipump/PCS") 5. External control signal (selection between "Off", "Setpoint2" and "Standby")	X X X – –	X O X O O
 Protection Options	This menu item makes available: 1) Setpoint2 (to input the second setpoint) 2) Setpoint minimum (to input the lower limit of the adjustable setpoint) 3) Setpoint maximum (to input the upper limit of the adjustable setpoint) 4) Power failure automatic (select between "Off" and "Automatic")	– X X X	O X X X
 System	This menu item makes available: 1) Heating output (only with temperature control units; setting in %) 2) Select Language (choose between "English" and "German") 3) Cooling bath (select between "Without cooling bath" (Off), "With cooling bath and common power supply" (On) and "With cooling bath and separate power supply" (On)) 4) System Information (display different serial numbers (Serial Number) and version statuses) 5) Service menu (only for Huber service technicians. This submenu is password protected) 6) Factory settings (choose between "Continue" and "Cancel")	X X M X X X	M X – X X X
X = standard, O = optional, M = model-dependent – = not possible			



## 3.6 Functional examples

### 3.6.1 Selecting a language

#### PROCEDURE

- Press both >Arrow keys< [B] to invoke the main menu.
- Use the >Arrow keys< [B] to select the menu item "System".
- Press the >SET key< [C] to confirm your selection.
- Use the >Arrow keys< [B] to select the submenu "Select Language".
- Press the >SET key< [C] to confirm your selection.
- Use the >Arrow keys< [B] to select the desired language.
- Press the >SET key< [C] to confirm your selection.
- Press the >ESC key< [D] twice to return to the home screen.

### 3.6.2 Switching the cooling bath controller on/off

#### PROCEDURE

- Press both >Arrow keys< [B] to invoke the main menu.
- Use the >Arrow keys< [B] to select the menu item "System".
- Press the >SET key< [C] to confirm your selection.
- Use the >Arrow keys< [B] to select the submenu "Cooling bath".
- Press the >SET key< [C] to confirm your selection.
- Use the >Arrow keys< [B] to select the desired setting.
- Press the >SET key< [C] to confirm your selection.
- Press the >ESC key< [D] twice to return to the home screen.

### 3.6.3 Setting the setpoint

#### PROCEDURE

##### Using the home screen to set the setpoint

- Press the >SET key< [C].
- Use the >Arrow keys< [B] (⊕ (+) or ⊖ (-)) to set the new setpoint.  
The longer you keep an arrow key pressed the faster the value changes.
- Press the >SET key< [C] to confirm your input.

### 3.6.4 Changing the Auto-Start function

Following a power outage (or when switching on the temperature control unit), this function can be used to determine how the temperature control unit is supposed to respond.

#### Auto-Start function is turned off

The temperature control is started only by manual input when the temperature control unit is turned on.

#### Auto-Start function is turned on

The temperature control unit is set to the same state it was in before the power outage. For example, before the power outage: Thermoregulation is off; after power outage: Thermoregulation is off. If temperature control is active during a power outage, the process will automatically continue after the power outage.

#### PROCEDURE

- Press both >Arrow keys< [B] to invoke the main menu.
- Use the >Arrow keys< [B] to select the menu item "Protection Options".
- Press the >SET key< [C] to confirm your selection.
- Use the >Arrow keys< [B] to select the submenu "Power Failure Automatic".
- Press the >SET key< [C] to confirm your selection.
- Use the >Arrow keys< [B] to select the desired setting.
- Press the >SET key< [C] to confirm your selection.
- Press the >ESC key< [D] twice to return to the home screen.

## 4 Setup mode

### 4.1 Setup mode



**Moving the temperature control unit during operation**  
**SERIOUS BURNS/FREEZING OF THE HOUSING PARTS/ESCAPING THERMAL FLUID**  
 ➤ Do not move temperature control units that are in operation.

#### 4.1.1 Turning on the temperature control unit

##### PROCEDURE

- The temperature control unit must be filled with thermal fluid before you turn it on via the **>Mains switch< [37]** (see on page 37 Section »Filling, venting, degassing and draining«). An error message appears on the display after a short time if the temperature control unit is switched on without thermal fluid. If this is the case, switch off the temperature control unit using the **>Mains switch< [37]** and fill it.
- Switch on the temperature control unit using the **>Mains switch< [37]**. The float switch monitors the thermal fluid level. The float switch is automatically pressed down. The buoyancy of the float forces it upwards when thermal fluid is filled and thus the test is passed. The test may generate some sounds.  
Circulation and thermoregulation are turned off.

#### 4.1.2 Turning off the temperature control unit

##### PROCEDURE

- Warm the thermofluid to room temperature.
- Stop the thermoregulation.
- Switch off the temperature control unit using the **>Mains switch< [37]**.

#### 4.1.3 Cooling/heating baths: Power On/Off

Positions of the **>Mains Switch< [37]** (schematic representation)

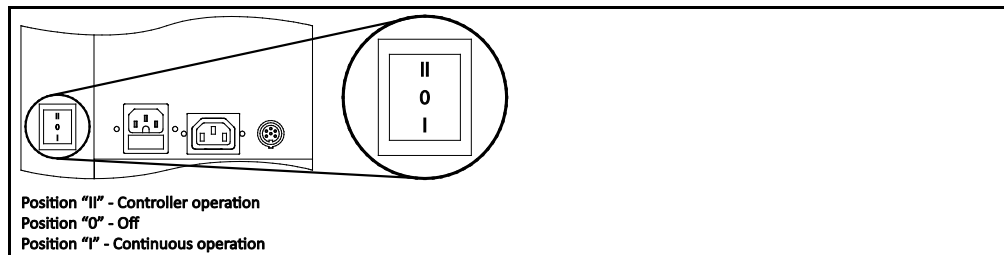

##### 4.1.3.1 Cooling/heating baths: Switching on (without an immersion circulator thermostat)

##### PROCEDURE

- Switch on the cooling bath using the **>mains switch< [37]** (Position "I" continuous operation). The maximum cooling capacity of the cooling bath is permanently available in "continuous operation" (Position "I" of the **>mains switch< [37]**).

##### 4.1.3.2 Cooling/heating baths: Switching off (without an immersion circulator thermostat)

##### PROCEDURE

- Switch off the cooling bath using the **>mains switch< [37]** (Position "0").

#### 4.1.3.3 Cooling/heating baths: Switching on (with an immersion circulator thermostat)

##### INFORMATION

The cold bath in combination with a hanger thermostat must only be used in switch position "II" - controller operation (on the cooling bath). The fuse may be tripped by excessive current consumption if ignored.

### PROCEDURE

- The temperature control unit must be filled with thermal fluid before you turn it on via the **>Mains switch< [37]** (see on page 37 Section »Filling, venting, degassing and draining«). An error message appears on the display after a short time if the temperature control unit is switched on without thermal fluid. If this is the case, switch off the temperature control unit using the **>Mains switch< [37]** and fill it.
- Switch on the **cooling bath** using the **>Mains switch< [37]** (Position "II" – controller operation).
- Switch on the **immersion circulator thermostat** using the **>Mains switch< [37]** (Position "I"). The float switch monitors the thermal fluid level. The float switch is automatically pressed down. The buoyancy of the float forces it upwards when thermal fluid is filled and thus the test is passed. The test may generate some sounds. Circulation and thermoregulation are turned off.

#### 4.1.3.4 Cooling/heating baths: Switching off (with an immersion circulator thermostat)

### PROCEDURE

- Switch off the **hanger thermostat** using the **>mains switch< [37]** (Position "0"). There is no need to switch off the cooling bath. Leave the **>mains switch< [37]** on Position "II" - controller operation. If the temperature control unit is to be switched off for an extended period, set the **>mains switch< [37]** on the cooling bath to position "0" - Off.

#### 4.1.4 Setting the overtemperature (OT) protection



The overtemperature protection is set higher than the ignition temperature of the thermal fluid used

##### MORTAL DANGER FROM FIRE

- The overtemperature protection must be correctly set to the thermal fluid you are using.
- Always observe the safety data sheet of the thermal fluid.
- Set the cut-out value of the overtemperature protection at least 25 K below the combustion point of the thermal fluid.

##### 4.1.4.1 General information on the overtemperature protection

Example of a potentiometer at the temperature control unit

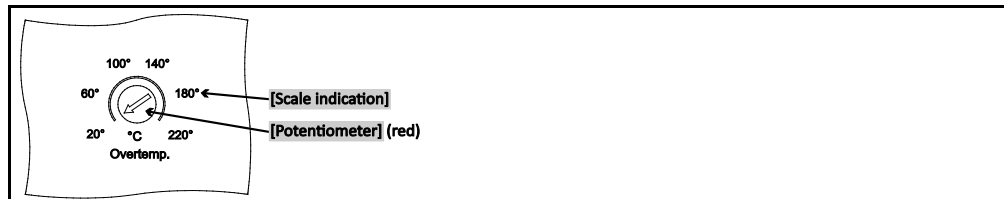

The overtemperature protection is installed only in temperature control units that have a heater. The flow temperature is monitored to ensure the safety of your system. It is set immediately after you have filled the system with thermal fluid.

Upon delivery, the cut-out value of the overtemperature protection is set to 40 °C. An alarm is triggered by the temperature control unit shortly after turning on the power if the temperature of the thermal fluid just filled is higher than the cut-out value set for the overtemperature protection. Set the overtemperature protection to the thermal fluid you are using. Please note: The printed scale can deviate by - 25 K from the set cut-out value.

**4.1.4.2 Setting the overtemperature protection**

Setting the cut-out value

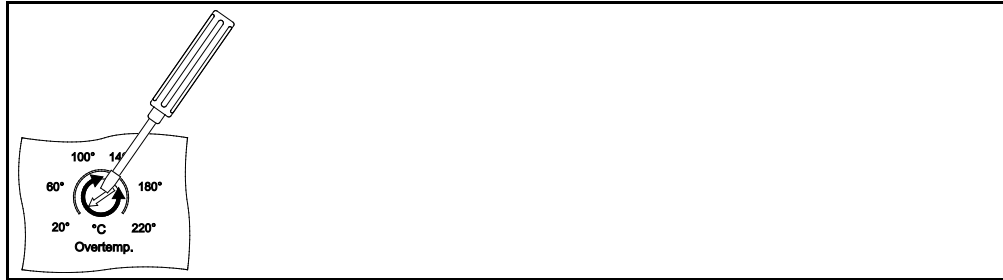

**INFORMATION**

You need a screwdriver (flat blade 1.0 x 5.5) to set the cut-out value of the overtemperature protection.

**PROCEDURE**

- Use a screwdriver to set the cut-off value on the potentiometer. The cut-out value must be set to match the thermal fluid you are using. It is not required to switch on the temperature control unit.

**4.1.5 Testing overtemperature protection for functionality**

**DANGER**

**Overtemperature protection (OT) does not trip**

**MORTAL DANGER FROM FIRE**

- Test the response of the device every month and after each change of the thermal fluid in order to assure proper functioning.

**NOTE**

**The steps below are carried out without permanent monitoring of the temperature control unit**

**DAMAGE TO AND IN THE VICINITY OF THE TEMPERATURE CONTROL UNIT**

- The following actions may only be carried out while constantly monitoring the temperature control unit and the application!

**INFORMATION**

The overtemperature protection is installed only in temperature control units that have a heater. You need a sufficiently large-sized screwdriver to check the overtemperature protection for functionality.

**Steps to test the correct functioning of the overtemperature protection:**

**PROCEDURE**

- Note down the cut-out value of the overtemperature protection set on the potentiometer.
- Switch on the temperature control unit.
- Enter a setpoint (room temperature). Further information can be found on page 33 in section »Setting the setpoint«.
- Press the **>Start/Stop button< [E]** to start temperature control.
- Use a screwdriver to set the new cut-off value on the potentiometer. This shutdown value must be **below** the displayed internal temperature. The overtemperature protection is triggered.
- Turn off the temperature control unit.
- Use a screwdriver to reset the cut-off value on the potentiometer to the original value.

**INFORMATION**

Immediately take the temperature control unit out of operation if the overtemperature protection is not triggered. Immediately contact Customer Support. The telephone number can be found on page 58, section »Phone number and company address«. Do not put the temperature control unit back into operation.

## 4.2 Filling, venting, degassing and draining

The illustration “connection diagram” can be found on page 60 in section »Annex«.



### Extremely hot / cold surfaces, connections and thermal fluids

#### BURNS/FREEZING OF LIMBS

- Surfaces, connections and tempered thermal fluids can be extremely hot or cold depending on the operating mode.
- Avoid direct contact with surfaces, connections and thermal fluids!
- Wear your personnel protective equipment (e.g. temperature-resistant safety gloves, safety goggles).

### 4.2.1 Filling, venting, degassing and draining the bath thermostat



#### Non-compliance with the safety data sheet for the thermal fluid to be used

##### INJURIES

- Risk of injury to the eyes, skin, respiratory tract.
- The safety data sheet for the thermal fluid to be used must be read prior to using it and its content must be respected.
- Observe the local regulations/work instructions.
- Wear your personal protective equipment (e.g. temperature-resistant safety gloves, safety goggles, safety footwear).
- Danger of slipping because floor and work area are contaminated. Clean the work station and follow the instructions for the disposal of thermal fluid and material on page 15 in Section »Proper disposal of resources and consumables«.

#### 4.2.1.1 Filling and venting the bath thermostat and the externally closed application

### PROCEDURE

- Lift the >bath lid< [93] off the temperature control unit.
- Using the filling accessories (funnel and/or beaker), carefully fill in suitable thermal fluid (see page 26 in section »Information on the thermal fluids«. When filling, pay attention to any necessary measures such as grounding the containers, funnels and other accessories. The thermal fluid can flow via the hose connection to the external application. To clean the filling accessories, follow the instructions on page 15, section »Proper disposal of resources and consumables«.
- Switch on the temperature control unit.
- Set the setpoint to room temperature (about 20 °C). Further information on page 33 in section »Setting the setpoint«.
- Press the >Start/Stop button< [E] to start temperature control.
- The filling/venting process is complete when the bath vessel is filled sufficiently and the liquid level remains constant.
- Press the >Start/Stop button< [E] to stop temperature control.
- Put the >bath lid< [93] back on the bath opening.
- Switch off the temperature control unit.

#### INFORMATION

The volume expansion of the thermal fluid depends on the working temperature range you wish to work in. Do not go below the minimum bath level/minimal level when working at the “lowest” working temperature and there should be no overflow from the expansion vessel/temperature control unit when working at the “highest” working temperature. In case of overfilling, drain the excess amount of thermal fluid (see page 38 in Section »Draining the bath thermostat«). Check if the thermal fluid can be reused. On page 15 observe Section »Proper disposal of resources and consumables«.

- In case of overfilling, drain thermofluid via the >Drain< [8] into a suitable container (see page 38 in section »Draining the bath thermostat«. Check if the thermofluid can be reused. On page 15 observe section »Proper disposal of resources and consumables«.

#### 4.2.1.2 Degassing of bath thermostat



##### Hot or cold thermal fluid and surfaces

##### BURNS TO LIMBS

- Avoid direct contact with the thermal fluids or the surfaces.
- Wear your personnel protective equipment (e.g. temperature-resistant safety gloves, safety goggles, safety footwear).

##### INFORMATION

When changing from low-boiling thermal fluid (low-boiling components) to higher boiling thermal fluids, remains of the low-boiling component may remain in the temperature control unit. Depending on the working temperature, the low-boiling component begins to boil and gas bubbles are formed that cause the pump pressure to momentarily collapse. This may cause a safety shutdown. The gas bubbles reach the bath opening and can escape.

If ice crystals form on the evaporator coil, water has accumulated in the thermal fluid. Degas if this is the case, to avoid damage to the temperature control unit.

Thermal fluids are more or less hygroscopic (water-attracting). This effect increases, the lower the working temperature. The de-gassing mode below, which must be **permanently monitored**, also helps you remove any water residues from the temperature control circuit.

## PROCEDURE

- Follow venting with the degassing operation. Prerequisite: You have filled the temperature control unit in accordance with the instructions on page 37 in Section »Filling and venting the bath thermostat and the externally closed application« and/or cleaned it as per page 53 in Section »Rinsing the thermal fluid circuit«.
- Enter a setpoint as described on page 33 in Section »Setting the setpoint«. This setpoint must be below the lower boiling thermal fluid. This setpoint will be increased in 10 K steps during the degassing process up to the maximum working temperature.
- Start the temperature control process as described on page 40 in Section »Starting the temperature control process«.
- Carry out temperature control to the entered setpoint until no more gas bubbles rise up.
- Increase the setpoint by 10 K and carry out temperature control until no more gas bubbles rise up.
- Repeat increasing the setpoint by 10 K until the maximum working temperature of the thermal fluid has been reached.
- Stop the temperature control process as described on page 40 in Section »Ending the temperature control process«.
- The de-gassing process is complete.

#### 4.2.1.3 Draining the bath thermostat



##### Hot or very cold thermal fluid

##### SERIOUS BURNS/FREEZING OF LIMBS

- Before draining, ensure that the thermal fluid has room temperature (20 °C).
- If, at this temperature, the thermal fluid is too viscous to be drained: Control the temperature of the thermal fluid for a few minutes until the viscosity will allow drainage. Never control the temperature of the thermal fluid when the Drain is open.
- Danger of burns when draining thermal fluids at temperatures above 20 °C.
- Wear your personal protective equipment when carrying out the drain operation.
- Only drain with a suitable draining hose and container. These must be resistant to the thermal fluid and the temperature.

## PROCEDURE

##### Baths with >Drain valve< [4]

- Remove the knurled screw at the >Drain< [8].
- Connect a suitable drain hose to the >Drain< [8].
- Place the other end of the hose in a suitable container.
- Open the >Drain valve< [4] by turning it counterclockwise (turn 90° left as far as it will go). The thermofluid will flow from the external application via the bath vessel and the draining hose into

the container. Check if the thermofluid can be reused. On page 15 observe section »**Proper disposal of resources and consumables**«.

- Wait until the external application and the bath are empty.
- Open the connection >**Circulation flow**< [1].
- Open the connection >**Circulation return**< [2].
- Leave the temperature control unit open for a while to allow it to dry out and the residue to drain. Without screw caps and with the >**Drain valve**< [4] open.
- Close the >**Drain valve**< [4] by turning it clockwise (turn 90° right as far as it will go).
- Close the connection >**Circulation flow**< [1].
- Close the connection >**Circulation return**< [2].
- After drying out, remove the drain hose and re-fit the knurled screw to the >**Drain**< [8].
- The bath is now drained.

#### **Baths without >Drain valve< [4]**

- Have a suitable container ready to catch the thermal fluid.
- Open the knurled screw at the >**Drain**< [8]. As soon as you have opened the knurled screw, the thermal fluid will flow from the external application over the bath and into the container. Wait until the external application and the bath are empty. Check if the thermal fluid can be reused. On page 15 observe Section »**Proper disposal of resources and consumables**«.
- Open the connection >**Circulation flow**< [1].
- Open the connection >**Circulation return**< [2].
- Leave the temperature control unit open for a while for the residue to fully drain and to allow it to dry out (without screw caps).
- Close the connection >**Circulation flow**< [1].
- Close the connection >**Circulation return**< [2].
- Re-fit the knurled screw to the >**Drain**< [8].
- The bath is now drained.

## 5 Normal operation

### 5.1 Automatic operation



#### Extremely hot / cold surfaces, connections and thermal fluids

##### BURNS/FREEZING OF LIMBS

- Surfaces, connections and tempered thermal fluids can be extremely hot or cold depending on the operating mode.
- Avoid direct contact with surfaces, connections and thermal fluids!
- Wear your personnel protective equipment (e.g. temperature-resistant safety gloves, safety goggles).

#### 5.1.1 Temperature control

##### 5.1.1.1 Starting the temperature control process

The temperature control process can be started after filling and complete venting.

### PROCEDURE

- With the temperature control unit switched on and thermoregulation/circulation stopped, press the **>Start/Stop button<** [E]. Thermoregulation starts.

##### 5.1.1.2 Ending the temperature control process

#### NOTE

**When the temperature control unit is switched off, the thermal fluid temperature is higher/lower than room temperature**

##### DAMAGE TO THE TEMPERATURE CONTROL UNIT AND THE GLASS APPARATUS/APPLICATION

- Bring the thermal fluid up to room temperature using the temperature control unit.
- Do not close the shut-off valves in the thermal fluid circuit.

Thermoregulation can be terminated at any time. Thermoregulation and circulation are switched off immediately afterwards.

### PROCEDURE

- With the temperature control unit switched on and thermoregulation/circulation started, press the **>Start/Stop button<** [E]. Thermoregulation stops.



## 5.2 Cooling/heating baths: Automatic operation (without an immersion circulator thermostat)



**Extremely hot / cold surfaces, connections and thermal fluids**

**BURNS/FREEZING OF LIMBS**

- Surfaces, connections and tempered thermal fluids can be extremely hot or cold depending on the operating mode.
- Avoid direct contact with surfaces, connections and thermal fluids!
- Wear your personnel protective equipment (e.g. temperature-resistant safety gloves, safety goggles).

### 5.2.1 Cooling/heating baths: Temperature control

#### 5.2.1.1 Cooling/heating baths: Starting the temperature control process

The temperature control process can be started after filling.

### PROCEDURE

- Turn on the cooling bath (Position "1" - continuous operation).  
The maximum cooling capacity of the cooling bath is permanently available in "continuous operation" (Position "1").

#### 5.2.1.2 Cooling/heating baths: Ending the temperature control process

**NOTE**

**When the temperature control unit is switched off, the thermal fluid temperature is higher/lower than room temperature**

**DAMAGE TO THE TEMPERATURE CONTROL UNIT AND THE GLASS APPARATUS/APPLICATION**

- Bring the thermal fluid up to room temperature using the temperature control unit.
- Do not close the shut-off valves in the thermal fluid circuit.

The temperature control process can be ended at any time.

### PROCEDURE

- Turn off the cooling bath (Position "0" - continuous operation).

## 6 Interfaces and data communication

**NOTE**

The specifications of the interface used are not being met.

**PROPERTY DAMAGE**

➤ Only connect components that meet the specifications of the interface used.

### 6.1 Controller interfaces

Standard interfaces on the top side of "KISS"

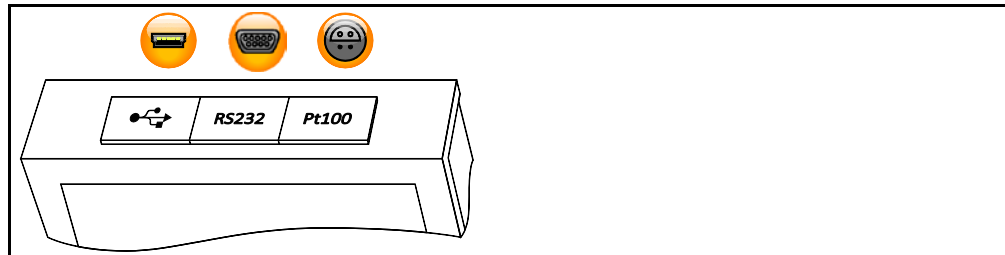

#### 6.1.1 USB-2.0 interface

**INFORMATION**

The interfaces used must meet the specifications of the generally accepted standards. The necessary drivers for the interface can be found at: [www.ftdichip.com/Drivers/VCP.htm](http://www.ftdichip.com/Drivers/VCP.htm)

##### 6.1.1.1 USB-2.0 interface, device



USB-2.0 connection (for Mini-B connector) for communicating with a computer.

##### 6.1.2 RS232 jack



A PC, a SPS or a Process Control System (PCS) can be connected to this jack for remote control of the controller electronics. Before plugging in the cable, check the settings in the "Interfaces" category and adjust if necessary.

**INFORMATION**

The interfaces used must meet the specifications of the generally accepted standards.

Pin assignment (front view)



Pin assignment

Pin	Signal	Description
2	RxD	Receive Data
3	TxD	Transmit Data
5	GND	Signal GND

##### 6.1.3 Pt100 process display sensor port (option)



A temperature sensor located in the connected application (Pt100, 4-wire technology, Lemosa connector) is connected to the Pt100 port. It records and displays the external actual temperature.

**INFORMATION**

Only use **shielded** sensor cables. We recommend the external Pt100 process sensor from the Huber accessories program.

Pin assignment (front view)



Pin assignment

Pin	Signal
1	I+
2	U+
3	U-
4	I-

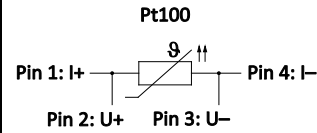

## 6.2 Cooling/heating baths: Interfaces at the back

Interfaces at the back of the cooling bath

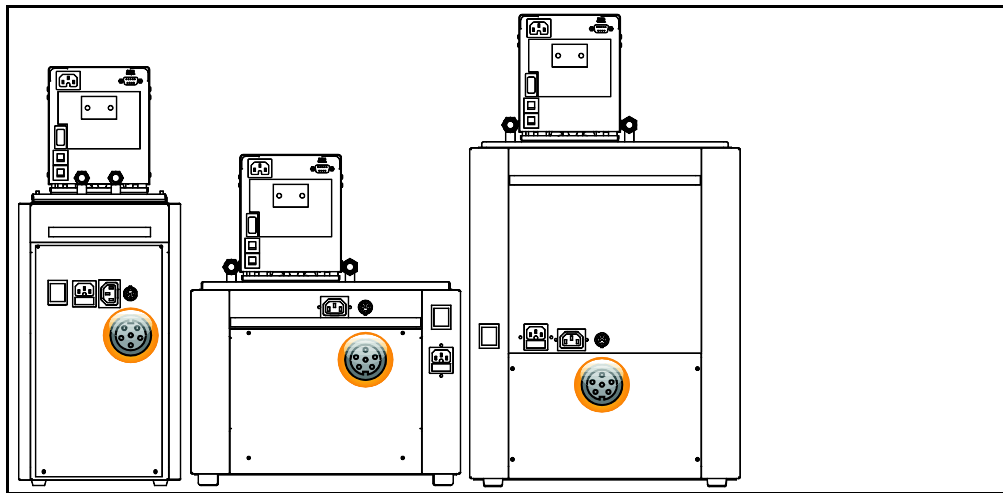

### 6.2.1 Activation connector



This connector is used to connect the cooling bath with the hanger thermostat. This enables control of the cooling bath via the hanger thermostat.

## 6.3 Cooling/heating baths: Interfaces on the hanger thermostat

Interfaces at the back of the immersion circulator thermostat

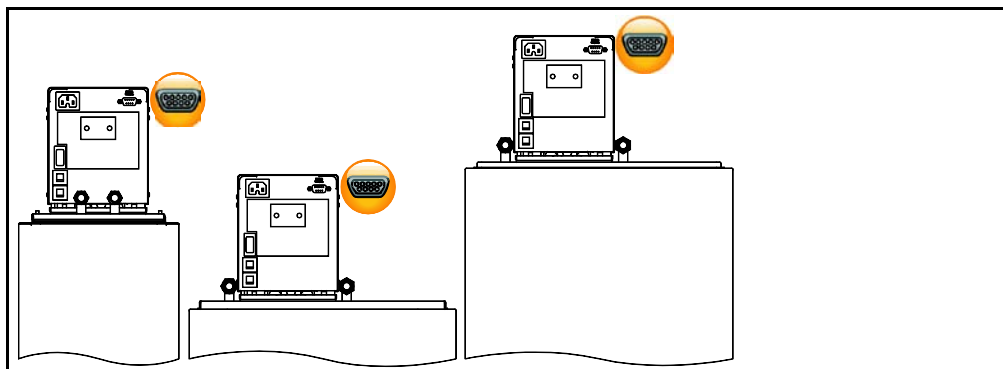

### 6.3.1 RS232 jack



A PC, a SPS or a Process Control System (PCS) can be connected to this jack for remote control of the controller electronics. Before plugging in the cable, check the settings in the “Interfaces” category and adjust if necessary.

**INFORMATION**

The interfaces used must meet the specifications of the generally accepted standards.

Pin assignment (front view)



Pin assignment

Pin	Signal	Description
2	RxD	Receive Data
3	TxD	Transmit Data
5	GND	Signal GND

## 6.4 Data communication

The communication via the RS232 interface is a master-slave communication. The Master (e.g. PC or PLC) starts a communication and the slave (the temperature control unit) will only respond to a request.

**Transmission format:**

8 data bits, 1 stop bit, no parity, no handshake

These parameters are non-adjustable and cannot be changed! The baud rate can be set in a range from 9600 baud to 115200 baud.

**Time response (timing):**

The data flow of a command must not be interrupted. Pauses of more than 100 ms between the characters of a command result in the receiver aborting the incoming command. The temperature control unit will always send a response for a correctly received command. The next command can be sent once a complete response was received. The typical response time is less than 300 ms.

**INFORMATION**

You need the software “SpyControl” to transmit commands. The software can be downloaded from the download area of [www.huber-online.com](http://www.huber-online.com).

### 6.4.1 LAI commands

There are 3 commands to communicate LAI commands to the temperature control unit:

1. “V” (Verify) – to query the device ID,
2. “L” (limit) – to query the device limits,
3. “G” (General) – to control and query the temperature control unit.

The send commands always begin with “[M01”, answers always with “[S01”, followed by the command qualifier “V” (Verify), “L” (Limits) or “G” (General). The next two bytes specify the length or the response of the command. A check sum is transmitted to increase data safety. The checksum is the 1 byte sum of all hex values from the start character to the last character before the checksum. It is appended to the end of the command or the response and then finished off with the end character CR (“\r”, 0Dh).

Structure of a send command

Byte	Command	Response	Description
1 Byte	[	[	Start character, fix
2 Byte	M	C	Identification of the transmitter (M = Master, S = Slave)
3 bytes	0	0	Slave address, fix
4 bytes	1	1	Slave address, fix
5 bytes	V / L / G	V / L / G	Command qualifier (V = Verify, L = Limit, G = General)

Byte	Command	Response	Description
6 bytes	0	1	Length of command / response (example)
7 bytes	7	4	Length of command / response (example)
n Bytes	x	x	If applicable, content; the number of bytes depends on the command
l-2 byte	C	C	Checksum (example)
l-1 byte	6	1	Checksum (example)
l byte	\r	\r	End-of-text character CR

**6.4.1.1 Command “V” (Verify)**

This command is provided to check the presence of a slave and query its ID.

Command structure  
“V” (Verify)

Byte	ASCII	Hex	Description
Master sends: <b>[M01V07C6\r</b>			
1. Byte	[	5Bh	Start character
2. Byte	M	4Dh	Master ID
3. Byte	0	30h	Slave address
4. Byte	1	31h	Slave address
5. Byte	V	56h	Command qualifier
6. Byte	0	30h	Length of data field (0)
7. Byte	7	37h	Length of data field (7)
8. Byte	C	43h	Checksum
9. Byte	6	36h	Checksum
10. Byte	\r	0Dh	End character CR
The checksum is formed from bytes 1 to 7: $5Bh + 4Dh + 30h + 31h + 56h + 30h + 37h = 1C6h = 1 \text{ byte sum} = C6h$ The hex value C6h is appended as two ASCII characters “C” (43h) and “6” (36h).			
The slave responds: <b>[S01V14Huber ControlC1\r</b> The 13 bytes of the data set “Huber Control” plus the 7 bytes in front of the data set result in a data field length of 20 bytes = 14h bytes.			

**6.4.1.2 Command “L” (Limit)**

This command is used to query the setpoint limits.

Command structure  
“L” (Limit)

Byte	ASCII	Hex	Description
Master sends: <b>[M01LOF*****1B\r</b>			
The slave responds: <b>[S01L17F4484E20F4484E2045\r</b>			

A response always includes four limit values (starting from the eighth byte):

1. Lower setpoint limit (4 bytes),
2. upper setpoint limits (4 bytes),
3. lower working range limit (4 bytes),
4. upper working range limit (4 bytes).

The working range limits are device-specific and cannot be changed. The lower setpoint limit can not be lower than the lower working range limit and the upper setpoint limit can not exceed the upper working range limit.

The two bytes before the last byte contain the checksum and the last byte of the response contains the end character (CR).

Each of the four values is expressed as a hex value. The values are signed, where 1 bit corresponds to 0.01 K. Thus a number range from 0000h to 7FFFh, i.e. from 0.00 °C to 327.67 °C, can be represented. Negative numbers are represented from FFFFh to 8000h, i.e. from -0.01 °C to -327.66 °C. Thus the four individual ASCII characters "F448" correspond to a 16-bit hex value of F448h and thus a temperature of -30 °C (also see on page 46 Section »Command "G" (General)«).

### 6.4.1.3 Command "G" (General)

This command transmits the most important temperatures and status information in a cycle. A modified setpoint is not stored in the permanent memory, i.e. this value is lost when switching off the machine.

Structure Command  
"G" (General)

Byte	ASCII	Hex	Description
Master sends: <b>[M01G0Dsatttpp\r</b>			
1. Byte	[	5Bh	Start character
2. Byte	M	4Dh	Master ID
3. Byte	0	30h	Slave address
4. Byte	1	31h	Slave address
5. Byte	G	47h	Command qualifier
6. Byte	0	30h	Length of the command: 0Dh = 13 bytes (number of bytes without checksum and end character)
7. Byte	D	44h	
8. Byte	s: C / I / O / *	43h / 49h / 4Fh / 2Ah	Temperature control mode Meaning of the characters in the send string: "C" (43h) = Circulation, switch circulation on; "I" (49h) = Turn internal temperature control on; "O" (4Fh) = Off, turn temperature control off; "*" (2 Ah) = Do not change the current state.
9. Byte	a: 0 / 1 / *	30h / 31h / 2Ah	Alarm acknowledgment Meaning of the characters in the send string: "0" (30h) = No alarm acknowledgment; "1" (31h) = Any pending alarm tone is acknowledged; "*" (2 Ah) = Do not change the current state.
10. Byte	t	tttt / ****	Query or set the setpoint Meaning of the characters in the send string: Setpoint with 16-bit resolution (2 bytes, thus 4 ASCII characters) "tttt" = 0000h (0.00 °C) to 7FFFh (327.67 °C) FFFFh (-0.01 °C) to 8000h (-327.68 °C) 0190h corresponds to +4 °C, (30h, 31h, 39h, 30h) FE70h corresponds to -4 °C (46h, 45h, 37h, 30h) "****" (2Ah, 2Ah, 2Ah, 2Ah) = no change to the setpoint, setpoint is only queried
11. Byte	t		
12. Byte	t		
13. Byte	t		
14. Byte	p	Checksum	Checksum
15. Byte	p	Checksum	It is generated from bytes 1 to 13.
16. Byte	\r	0Dh	End character CR

Byte	ASCII	Hex	Description
The slave responds: <b>[S01G15sattttiiiiieepp\r</b>			
1. Byte	[	5Bh	Start character
2. Byte	C	53h	Slave ID
3. Byte	0	30h	Slave address
4. Byte	1	31h	Slave address
5. Byte	G	47h	Command qualifier
6. Byte	1	31h	Length of response: 15h = 21 Bytes
7. Byte	5	35h	
8. Byte	s: C / I / O	43h / 49h / 4Fh	Temperature control mode Meaning of the characters in the response string: "C" (43h) = Circulation, circulation is on; "I" (49h) = Internal temperature control is on; "O" (4Fh) = Off, temperature control is off.
9. Byte	a: 0 / 1	30h / 31h	Alarm status Meaning of the characters in the response string: "0" (30h) = No alarm; "1" (31h) = Any number other than "0" is an alarm
10. Byte	t	tttt / ****	Query or set the setpoint Meaning of the characters in the send string: Setpoint with 16-bit resolution (2 bytes, thus 4 ASCII characters) "tttt" = 0000h (0.00 °C) to 7FFFh (327.67 °C) FFFFh (-0.01 °C) to 8000h (-327.68 °C) 0190h corresponds to +4 °C, (30h, 31h, 39h, 30h) FE70h corresponds to -4 °C (46h, 45h, 37h, 30h) "****" (2Ah, 2Ah, 2Ah, 2Ah) = no change to the setpoint, setpoint is only queried
11. Byte	t		
12. Byte	t		
13. Byte	t		
14. Byte	i	iiii	Internal actual value Same format as setpoint
15. Byte	i		
16. Byte	i		
17. Byte	i		
18. Byte	e	eeee	External actual value Same format as setpoint, depends on device configuration
19. Byte	e		
20. Byte	e		
21. Byte	e		
22. Byte	p	Checksum	Checksum It is generated from bytes 1 to 21.
23. Byte	p	Checksum	
24. Byte	\r	0Dh	End character CR

**Example:**

The temperature control mode and the alarm status should remain unchanged (each "\*\*") and a setpoint of -4.00 °C (FE70) is to be set.

The master sends: **[M01G0D\*\*FE700A\r**

The slave responds (for example): **[S01G1500FE7009A4C504E7\r**

The temperature control unit is turned off ("O"), there is no alarm ("0"), the setpoint of -4.00 °C was set (FE70), the actual value is 24.68 °C (09A4), "C504" corresponds to -151.00 °C and indicates that no external temperature sensor is installed or connected.

## 6.4.2 PP commands

There is another set of commands to make the communication with the temperature control unit easy. The PP commands can be used, e.g. in conjunction with simple terminal programs. The calculation of a checksum has therefore been omitted and the commands kept very simple. Each command is terminated with Carriage Return ('\r', 0Dh) and Linefeed ('\n', 0Ah). There are read and write commands. Each correct command causes a response from the temperature control unit. Temperature and setpoint values are represented by a five-digit number, which corresponds to the temperature being expressed in hundredths of a degree (without decimal point).

Function	Master sends	Slave responds	Description
Available read commands	<b>Read the setpoint</b>	SP?\r\n	SP +02500\r\n The setpoint is set to 25.00 °C.
	<b>Read the internal actual value</b>	TI?\r\n	TI +02499\r\n Currently, the internal actual value is 24.99 °C.
	<b>Read the external actual value</b>	TE?\r\n	TE +02499\r\n Currently, the external actual value is 24.99 °C.
			TE -15100\r\n An external sensor is not connected or does not exist.
<b>Read the temperature control mode</b>	CA?\r\n	CA +00000\r\n Temperature control and circulation are inactive.	
		CA +00001\r\n Temperature control and circulation are active.	
Function	Master sends	Slave responds	Description
Available write commands	<b>Setting the setpoint</b>	SP@ -01234\r\n	SP -01234\r\n The setpoint is set to -12.34 °C.
	<b>Starting the temperature control unit</b>	CA@ 00001\r\n	CA +00001\r\n The temperature control process is started.
	<b>Stopping the temperature control unit</b>	CA@ 00000\r\n	CA +00000\r\n The temperature control process is stopped.



## 7 Service/maintenance

### 7.1 Displays in the event of faults

An alarm signal (xx Hz) is sounded in the event of a fault and the temperature control unit displays an alarm or warning message on the OLED display.

Overview of messages

Code	Cause	Effect, measure
001	<b>Overtemperature alarm</b> The internal temperature is above the set value of the overtemperature protection. The overtemperature protection was triggered.	The internal temperature of the thermal fluid is in the upper allowable extreme range. The temperature control unit can be turned on again only when the temperature of the thermal fluid has returned to normal parameters. Check whether the thermal fluid used matches your required parameters if overtemperatures repeatedly shut down the unit.
002	<b>Tmax exceeded</b> The internal temperature is above the set setpoint limit.	The internal temperature of the thermal fluid is above the setpoint limit set in the controller. Control continues.
003	<b>Tmin undercut</b> The internal temperature is below the set setpoint limit.	The internal temperature of the thermal fluid is below the setpoint limit set in the controller. Control continues.
004	<b>Error float test</b>	Check the thermal fluid level. KISS: Is the float blocked or sticky? Please contact Customer Support if the thermal fluid level is sufficient and the float of the KISS controller moves freely.
005	<b>Low-level alarm</b> No enable signal, level alarm	Control is inactive. (Pump off, compressor off, heating off) Check the fill level of the thermal fluid. <b>Restart impossible until the thermal fluid level is OK.</b>
006	<b>Overpressure cutout triggered</b> The pressure in the condenser is too high. The overpressure cutout (pressure switch) has triggered.	Temperature and pressure increase in the condenser. An overpressure cutout (pressure switch) is installed to protect the temperature control unit against excessive pressure.  <b>Water cooling:</b> a.) Is the cooling water supply correctly connected? b.) Is the suction strainer (dirt trap) clogged? c.) What is the cooling water temperature, the cooling water flow rate and the cooling water pressure?  <b>Air cooling:</b> a.) Is the heat exchanger or the grille dirty? b.) Does the fan turn if the cooling machine is switched on? If the fan does not turn: Contact Customer Support.
009 011	<b>Sensor F1 short</b> <b>Sensor F2 short</b> Short-circuit at the internal temperature sensor F1 or at the external temperature sensor F2.	Control is inactive. (Pump off, compressor off, heating off) <b>Check the sensor.</b>
010 012	<b>Sensor F1 open</b> <b>Sensor F2 open</b> The internal temperature sensor F1 or the external temperature sensor F2 is open.	Control is inactive. (Pump off, compressor off, heating off) <b>Check the sensor.</b>

Code	Cause	Effect, measure
033	Error EP0 (Flash)	Please contact Customer Support.
034	Error EP1 (EEPROM)	
035	Error EP2 (NVRAM)	
036	Synchronization	
037	Parameters not equal	
038	Invalid status	
039	Error safety chip	
042	Pump protection activated The pump motor is overheated.	Check the ambient conditions. Check the viscosity of the thermal fluid. Turn the temperature control unit off and let it cool down.

## 7.2 Electrical fuse

Position of fuses



The thermal overcurrent circuit breakers for all pole breaking (L and N) are located at the back of the hanger thermostat. In case of a fault (no function and no display on the hanger thermostat) please first check if the overcurrent circuit breaker has tripped. If the overcurrent circuit breaker triggers again immediately after reversing, please unplug the power cord and contact Customer Support immediately (see phone number can be found on page 58 in section »Phone number and company address«).

## 7.3 Maintenance



### Cleaning/maintenance while the temperature control unit is operating

#### MORTAL DANGER FROM ELECTRIC SHOCK

- Stop an ongoing temperature control process.
- Turn off the temperature control unit.
- Also disconnect the temperature control unit from the power supply.



### Carrying out maintenance work not described in this operation manual

#### DAMAGE TO THE TEMPERATURE CONTROL UNIT

- For maintenance work not described in the operation manual, contact the Huber company.
- Maintenance work not described in this operation manual is reserved for qualified specialists trained by Huber.
- Only perform the following maintenance work on the temperature control unit yourself.

### 7.3.1 Function check and visual inspection

Monitoring interval

Cooling*	Description	Maintenance interval	Comment	Person responsible
L/W	Visually inspect hoses and hose connections	Prior to switching on the temperature control unit	Exchange leaking hoses and hose connections prior to switching on the temperature control unit. Please see page 51 Section <b>»Replacing temperature control hoses«</b> .	Responsible body and/or operators
L/W	Inspect power supply cable	Prior to switching on the temperature control unit or on relocation	Do not start the temperature control unit if the power cable is damaged.	Qualified electrician (BGV A3)
L	Clean air inlet grille	As required	Clean the perforated sheet of the temperature control unit with a damp cloth	Responsible body
L/W	Thermal fluid inspection	As required	–	Responsible body and/or operators
L	Check liquefier fins	As required, after 3 months at the latest	Please see page 52 Section <b>»Clean liquefier fins (air-cooled temperature control unit)«</b>	Responsible body and/or operators
L/W	Overtemperature protection (OT) - functional check	Every month or after changing the thermal fluid	Please see page 36 Section <b>»Testing overtemperature protection for functionality«</b>	Responsible body and/or operators
L/W	Inspect temperature control unit for damage and stability	Every 12 months or after a change of location	–	Responsible body and/or operators

\*L = Air cooling; W = Water cooling; U = Applicable only for Unistats

### 7.3.2 Replacing temperature control hoses

Replace defective temperature control hoses **before** turning on the temperature control unit.

#### PROCEDURE

- Drain the temperature control unit as described on page 38 in Section **»Draining the bath thermostat«**.
- Replace defective temperature control hoses. When disposing of them, observe on page 15 Section **»Proper disposal of resources and consumables«**.
- Reconnect your external application as described on page 22 in Section **»Connecting externally closed application«**.
- Fill the temperature control unit with thermal fluid as described on page 37 in Section **»Filling and venting the bath thermostat and the externally closed application«**.
- Vent the temperature control unit as described on page 37 in Section **»Filling and venting the bath thermostat and the externally closed application«**.
- Restart the temperature control unit in normal mode.

### 7.3.3 Clean liquefier fins (air-cooled temperature control unit)

**CAUTION**

**Manual cleaning**

**RISK OF BEING CUT ON THE LIQUEFIER FINS**

- Wear suitable cut-resistant gloves for cleaning work.
- Depending on the ambient conditions, use cleaning equipment such as vacuum cleaners and/or a hand brush/brush. Follow the local regulations when cleaning. Do not clean the liquefier fins in a clean room with items like a brush and do not use a vacuum cleaner without an extra-fine particle filter.

**NOTE**

**Cleaning using pointed or sharp-edged tools**

**DAMAGE TO THE LIQUEFIER FINS**

- Clean the liquefier fins using suitable cleaning appliances.

**INFORMATION**

Make sure there is adequate ventilation (removal of waste heat, fresh air supply) for the temperature control unit, in case of **air cooling, maintain wall clearance** (see page 18 section »Ambient conditions«).

The liquefier fins must be cleaned (dust) from time to time as only then will the temperature control unit perform at its maximum cooling capacity.

Identify the position of the ventilation grille, usually located on the front. With some temperature control units, the ventilation grilles on the side wall, rear or on the underside (table units) of the temperature control unit.

## PROCEDURE

**Ventilation grille on the front/rear or on a side wall**

- Turn off the temperature control unit.
- Disconnect the temperature control unit from the power supply.
- Remove the ventilation grille to create unhindered access to the liquefier fins.
- Clean the liquefier fins using suitable cleaning appliances. Observe the local regulations and ambient conditions when selecting cleaning appliances.
- Make sure the liquefier fins are not damaged or deformed as this will impair the air flow.
- Re-mount the ventilation grille after cleaning work.
- Connect the temperature control unit to the power supply.
- Turn on the temperature control unit.

## PROCEDURE

**Ventilation grille on the underside (table-top units)**

**NOTE**

**Cleaning of liquefier fins at the underside when the temperature control unit is filled**

**DAMAGE CAUSED BY THERMAL FLUID PENETRATING THE TEMPERATURE CONTROL UNIT**

- Empty the temperature control unit before cleaning the liquefier fins at the underside of the temperature control unit.

- Turn off the temperature control unit.
- Disconnect the temperature control unit from the power supply.
- Drain the thermofluid from the temperature control unit. Additional information is provided on page 38 in the section »Draining the bath thermostat«.
- Tilt the temperature control unit to remove the grille (if available) in front of the liquefier fins.
- Clean the liquefier fins using suitable cleaning appliances. Observe the local regulations and ambient conditions when selecting cleaning appliances.
- Make sure the liquefier fins are not damaged or deformed as this will impair the air flow.
- Re-mount the ventilation grille after cleaning work.
- Connect the temperature control unit to the power supply.
- Refill the temperature control unit with thermofluid. Additional information is provided on page 37 in the section »Filling and venting the bath thermostat and the externally closed application«.

## 7.4 Thermal fluid inspection, replacement and circuit cleaning

The illustration "connection diagram" can be found on page 60 in section »Annex«.

### CAUTION

#### Extremely hot / cold surfaces, connections and thermal fluids

##### BURNS/FREEZING OF LIMBS

- Surfaces, connections and tempered thermal fluids can be extremely hot or cold depending on the operating mode.
- Avoid direct contact with surfaces, connections and thermal fluids!
- Wear your personnel protective equipment (e.g. temperature-resistant safety gloves, safety goggles).

### 7.4.1 Thermal fluid inspection

#### CAUTION

##### Thermal fluid is not inspected on a regular basis

##### BURNS DUE TO REDUCED BOILING POINT

- Regularly check your thermal fluid whether it meets the specifications in the safety data sheet.

#### NOTE

##### Thermal fluid is not inspected on a regular basis

##### DAMAGE TO THE HEAT EXCHANGER AND/OR ELECTROMECHANICAL PARTS.

- Regularly check your thermal fluid whether it meets the specifications in the safety data sheet.

#### INFORMATION

##### Oxidation

Oxidation ages the thermal fluid and change its characteristics (e.g. a reduced boiling point). When controlling high temperatures, a reduced boiling point may cause overflow of very hot thermal fluids. It may cause serious burns of the limbs.

##### Hygroscopy

When continuously thermoregulating below room temperature, hygroscopy causes the thermal fluid to accumulate water in the course of time. Such a liquid mixture causes the evaporator to burst when thermoregulating in the minus range. This is caused by the water in the liquid mixture, which forms ice crystals on the evaporator. When thermoregulating high temperatures with such a liquid mixture, the boiling point is reduced. When controlling high temperatures, a reduced boiling point may cause overflow of very hot thermal fluids. It may cause serious burns of the limbs. Hygroscopy can change the mixing ratio of a water-ethylene-glycol mixture.

### 7.4.2 Rinsing the thermal fluid circuit

#### DANGER

##### Setpoint and overtemperature protection are not adjusted to the thermofluid

##### MORTAL DANGER FROM FIRE

- The cut-out value of the overtemperature protection **must** be adapted to the thermofluid. Set the cut-out value of the overtemperature protection 25 K below the combustion point of the thermofluid.
- The setpoint set during rinsing **must** be adjusted to the thermofluid used.

#### CAUTION

##### Non-compliance with the safety data sheet for the thermal fluid to be used

##### INJURIES

- Risk of injury to the eyes, skin, respiratory tract.
- The safety data sheet for the thermal fluid to be used must be read prior to using it and its content must be respected.
- Observe the local regulations/work instructions.
- Wear your personal protective equipment (e.g. temperature-resistant safety gloves, safety goggles, safety footwear).
- Danger of slipping because floor and work area are contaminated. Clean the work station and follow the instructions for the disposal of thermal fluid and material on page 15 in Section »Proper disposal of resources and consumables«.

**NOTE**

**Mixing different thermofluids in a thermal fluid circuit**

**PROPERTY DAMAGE**

- Do **not** mix different types of thermofluid (such as mineral oil, silicone oil, synthetic oil, water, etc.) in a thermofluid circuit.
- The thermal fluid circuit **must** be rinsed when changing from one type of thermal fluid to another. No residues of the previous type of thermal fluid may remain in the thermal fluid circuit.

Example: Connecting a short circuit hose

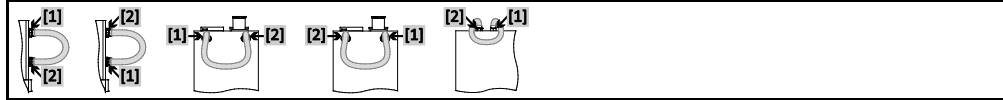

The inner components of the temperature control unit must be dried out. Need to avoid boiling retardation during future uses (e.g. use of a silicone oil at temperatures above about 100 °C).

**PROCEDURE**

- Drain the temperature control unit as described on page 38 in section »Draining the bath thermostat«.

**INFORMATION**

Residual thermal fluid can remain in the pump chamber and the internal lines after draining. Leave the temperature control unit with open valves for a while.

- Leave the drain hose mounted to the >Drain< [8].
- Check the fill level in the collecting container at the end of the drain hose. Follow the instructions on page 15, section »Proper disposal of resources and consumables« for the disposal of thermofluid.
- Close the drain valves on the temperature control unit by turning them clockwise (turn 90° right as far as it will go).
- Connect the >Circulation flow< [1] with the >Circulation return< [2] to the temperature control using a bypass hose.

**INFORMATION**

Perform the following steps without attaching a short circuit hose, if the application used by you (externally closed) is also dirty. In this case, leave your externally closed application connected to the temperature control unit. This rinses the temperature control unit and your application at the same time.

- **Fill** the system (minimum fill level) with the thermal fluid you wish to use. The description can be found on page 37 in section »Filling and venting the bath thermostat and the externally closed application«.
- **Vent** the system as described on page 37 in Section »Filling and venting the bath thermostat and the externally closed application«.
- Adjust the **setpoint** and the cut-out value of the **overtemperature protection** to the thermal fluid used. This procedure can be found on page 33 in Section »Setting the setpoint« and on page 35 in Section »Setting the overtemperature (OT) protection«.
- **Start** the **circulation** as described on page 40 in Section »Starting the temperature control process«. The length of rinsing depends on the level of soiling.
- **Stop** the **circulation** as described on page 40 in Section »Ending the temperature control process«.
- Open the >Drain< [8] and drain the thermal fluid through the draining hose into a suitable container (such as the original canister, which is compatible with the thermal fluid). Follow the instructions for the disposal of thermal fluid on page 15 in section »Proper disposal of resources and consumables«.
- Repeat the steps "Filling", "Venting", "Start/Stop circulation" and "Draining" until the drained thermal fluid remains clear.
- Remove the bypass hose.

**INFORMATION**

Leave an application connected, if you have simultaneously rinsed a used application (externally closed).

- Leave the >Drain< [8] open for a while to allow the thermofluid to evaporate in the temperature control unit.
- Close the >Drain< [8] once the residual thermofluid has evaporated.
- Dismount the drain hose.
- Remove the collecting container.
- Discard the collecting container, including its contents, properly. Follow the instructions on page 15, section »Proper disposal of resources and consumables« for the disposal of thermofluid.
- Re-connect your application. (Only if you have rinsed the thermofluid circuit using a bypass hose.)
- Fill the temperature control unit with thermofluid as described on page 37 in section »Filling and

- **venting the bath thermostat and the externally closed application«.**
- Drain the temperature control unit as described on page 37 in section »**Filling and venting the bath thermostat and the externally closed application«**. An externally open application does not need to be vented.
- Start the “degassing” function as described on page 38 in section »**Degassing of bath thermostat«**. An externally open application does not need to be de-gassed.
- Restart the temperature control unit in normal mode.

## 7.5 Cleaning the surfaces



### Extremely hot / cold surfaces, connections and thermal fluids

#### BURNS/FREEZING OF LIMBS

- Surfaces, connections and tempered thermal fluids can be extremely hot or cold depending on the operating mode.
- Avoid direct contact with surfaces, connections and thermal fluids!
- Wear your personnel protective equipment (e.g. temperature-resistant safety gloves, safety goggles).

### NOTE

#### Exposed plug contacts

#### DAMAGE CAUSED BY FLUID INGRESS

- Protect unused plug contacts with the protective caps supplied.
- Clean surfaces only with a damp cloth.

A standard stainless steel cleaning agent is suitable for cleaning the stainless steel surfaces. Carefully clean painted surfaces (damp only) using a solution of sensitive-fabrics detergent. Follow the instructions on page 15, section »**Proper disposal of resources and consumables«** for the disposal of cleaning agents and material.

## 7.6 Plug contacts

### NOTE

#### Exposed plug contacts

#### DAMAGE CAUSED BY FLUID INGRESS

- Protect unused plug contacts with the protective caps supplied.
- Clean surfaces only with a damp cloth.

Protective caps are supplied for all plug contacts. Make sure that any plug contacts not required are protective with the caps.

## 7.7 Decontamination/repairs



### Returning a not decontaminated temperature control unit for repair

#### PHYSICAL INJURY AND PROPERTY DAMAGE CAUSED BY HAZARDOUS MATERIALS IN OR ON THE TEMPERATURE CONTROL UNIT

- Carry out appropriate decontamination.
- The decontamination process depends on the type and quantity of the materials used.
- Consult the relevant safety data sheet.
- You will find a prepared return receipt at [www.huber-online.com](http://www.huber-online.com).

As the responsible body you are responsible for carrying out decontamination **before** third-party personnel come into contact with the temperature control unit / accessory. Decontamination must be carried out **before** the temperature control unit / accessory is returned for repair or inspection. Attach a clearly visible written notice stating that the temperature control unit / accessory has been decontaminated.

To simplify the process, we have prepared a form for you. This is available for download at [www.huber-online.com](http://www.huber-online.com).

## 8 Shutting down

### 8.1 Safety instructions and basic principles



**Connection/adjustment to the power supply not carried out by an electrician and/or connection to a power socket without protective earth (PE)**

**MORTAL DANGER FROM ELECTRIC SHOCK**

- Have the connection/adjustment to the power supply carried out by an electrician.
- Always connect the temperature control unit to safety sockets (PE).



**Damaged power cable/power cable connection**

**MORTAL DANGER FROM ELECTRIC SHOCK**

- Do not start up the temperature control unit.
- Isolate the temperature control unit from the power supply.
- Have the power supply cable/power supply connection replaced and inspected by an electrician.
- Do not use a power cable that is longer than **3 m**.



**Risk of tipping due to unstable temperature control unit**

**SERIOUS INJURY AND PROPERTY DAMAGE**

- Avoid risk of tipping due to unstable temperature control unit.



**Non-compliance with the safety data sheet for the thermal fluid to be used**

**INJURIES**

- Risk of injury to the eyes, skin, respiratory tract.
- The safety data sheet for the thermal fluid to be used must be read prior to using it and its content must be respected.
- Observe the local regulations/work instructions.
- Wear your personal protective equipment (e.g. temperature-resistant safety gloves, safety goggles, safety footwear).
- Danger of slipping because floor and work area are contaminated. Clean the work station and follow the instructions for the disposal of thermal fluid and material on page 15 in Section »Proper disposal of resources and consumables«.



**Hot or very cold thermal fluid**

**SERIOUS BURNS/FREEZING OF LIMBS**

- Before draining, ensure that the thermal fluid has room temperature (20 °C).
- If, at this temperature, the thermal fluid is too viscous to be drained: Control the temperature of the thermal fluid for a few minutes until the viscosity will allow drainage. Never control the temperature of the thermal fluid when the Drain is open.
- Danger of burns when draining thermal fluids at temperatures above 20 °C.
- Wear your personal protective equipment when carrying out the drain operation.
- Only drain with a suitable draining hose and container. These must be resistant to the thermal fluid and the temperature.

**INFORMATION**

All safety instructions are important and must be followed accordingly during working operations!

### 8.2 Switch-off

#### PROCEDURE

- Turn off the temperature control unit.
- Disconnect the temperature control unit from the power supply connection.



### 8.3 Draining the cooling water

**INFORMATION**

This section must be observed when using water-cooled temperature control units.

#### 8.3.1 Draining process

**CAUTION**

**Pressurized cooling water connections**

**RISK OF INJURY**

- Wear your personnel protective equipment (e.g. safety goggles).
- Carefully open the cooling water connection. Open slowly (1-2 signal edges) and drain the cooling water slowly.

**NOTE**

**Building side isolating valves are not closed**

**DAMAGE BY ROOM FLOODING**

- Close the building's isolating valves in the cooling water supply and return lines.

### PROCEDURE

- Close the building's isolating valve in the cooling water supply and return lines.
- Place the collecting container below the input and output of the **>Cooling coil<** [29].
- Unscrew the connection at the **>Cooling coil<** [29]. The cooling water will begin to drain from the lines.
- Remove the cooling water from the **>Cooling coil<** [29]. Allow the cooling water to fully drain to prevent the risk of freezing during transport and storage!

### 8.4 Packing

Use the original packaging wherever possible! Further information can be found on page 18 in section »Unpacking«.

### 8.5 Shipping

**NOTE**

**Temperature control unit transported in a horizontal position**

**DAMAGE TO THE COMPRESSOR**

- Only transport the temperature control unit in an upright position.

**NOTE**

**Temperature control unit transported incorrectly**

**PROPERTY DAMAGE**

- Do not transport by truck on the castors or feet.
- Comply all requirements in this section to avoid damage to the temperature control unit.

Pallet with squared timber for free-standing units

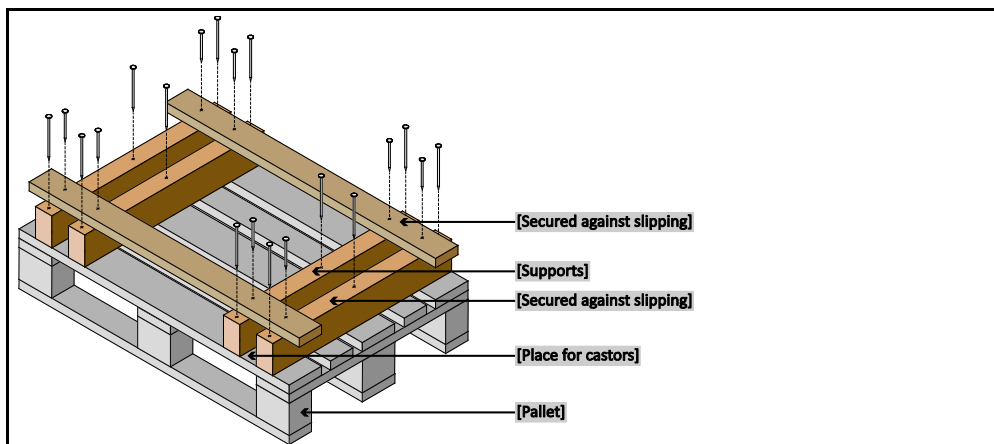

Transport using the lugs, if fitted, on the top of the temperature control unit. Do not transport the temperature control unit alone and without aids.

- Always use the original packaging for transport.
- Always transport the temperature control unit upright on a pallet!
- Protect attachments from damage during transport!
- During transport, place the temperature control unit on squared timber to protect the castors/feet.
- Secure with tensioning belts/lashing straps rated for the weight concerned.
- Additionally secure (depending on model) with plastic film, cardboard and straps.

## 8.6 Disposal

### CAUTION

**Uncontrolled or incorrect opening of the coolant circuit**

**RISK OF INJURY AND ENVIRONMENTAL DAMAGE**

- Work on the coolant circuit and disposal of the refrigerant must be carried out by approved refrigeration/air-conditioning system contractors.

### NOTE

**Improper disposal**

**ENVIRONMENTAL DAMAGE**

- Spilled/leaked thermofluid must be discarded immediately and correctly. Follow the instructions for the disposal of thermofluid and material on page 15 in section »**Proper disposal of resources and consumables**«.
- To avoid environmental damage, have "disused" temperature control units disposed of exclusively by approved waste management companies (e.g. refrigeration and air conditioning companies).

Huber temperature control units and Huber accessories are made of high quality, recyclable materials. For example: Stainless steel 1.4301 / 1.4401 (V2A), copper, nickel, FKM, Perbunan, NBR, ceramic, carbon, Al-Oxid, red brass, brass, nickel-plated brass and silver solder. Proper recycling of the temperature control unit and accessories can actively help reduce CO<sub>2</sub> emissions in the production of these materials. Follow the laws and regulations of your jurisdiction when disposing material.

## 8.7 Phone number and company address

### INFORMATION

Contact Customer Support **prior** to returning your temperature control unit. Have the serial number of your temperature control unit to hand. The serial number can be found on the rating plate on the temperature control unit.

### 8.7.1 Telephone number: Customer Support

Telephone: +49-781-9603-244

### 8.7.2 Telephone number: Sales

Telephone: +49-781-9603-123

### 8.7.3 Email address: Customer Support

Email: support@huber-online.com

### 8.7.4 Service/return address

Peter Huber Kältemaschinenbau AG  
Werner-von-Siemens-Straße 1  
77656 Offenburg

## 8.8 Certificate of Compliance

Please read page 55, section »Decontamination/repairs«.

## 9 Annex



# Inspired by **temperature** designed for you

Peter Huber Kältemaschinenbau AG  
Werner-von-Siemens-Str. 1  
77656 Offenburg / Germany

Telefon +49 (0)781 9603-0  
Telefax +49 (0)781 57211

[info@huber-online.com](mailto:info@huber-online.com)  
[www.huber-online.com](http://www.huber-online.com)

Technischer Service: +49 (0)781 9603-244

-125 °C ... +425 °C

**huber**