

ASSEMBLY INSTRUCTIONS FOR 30L & 50L JACKETED (300mm Flanges) PROCESS REACTOR SYSTEMS

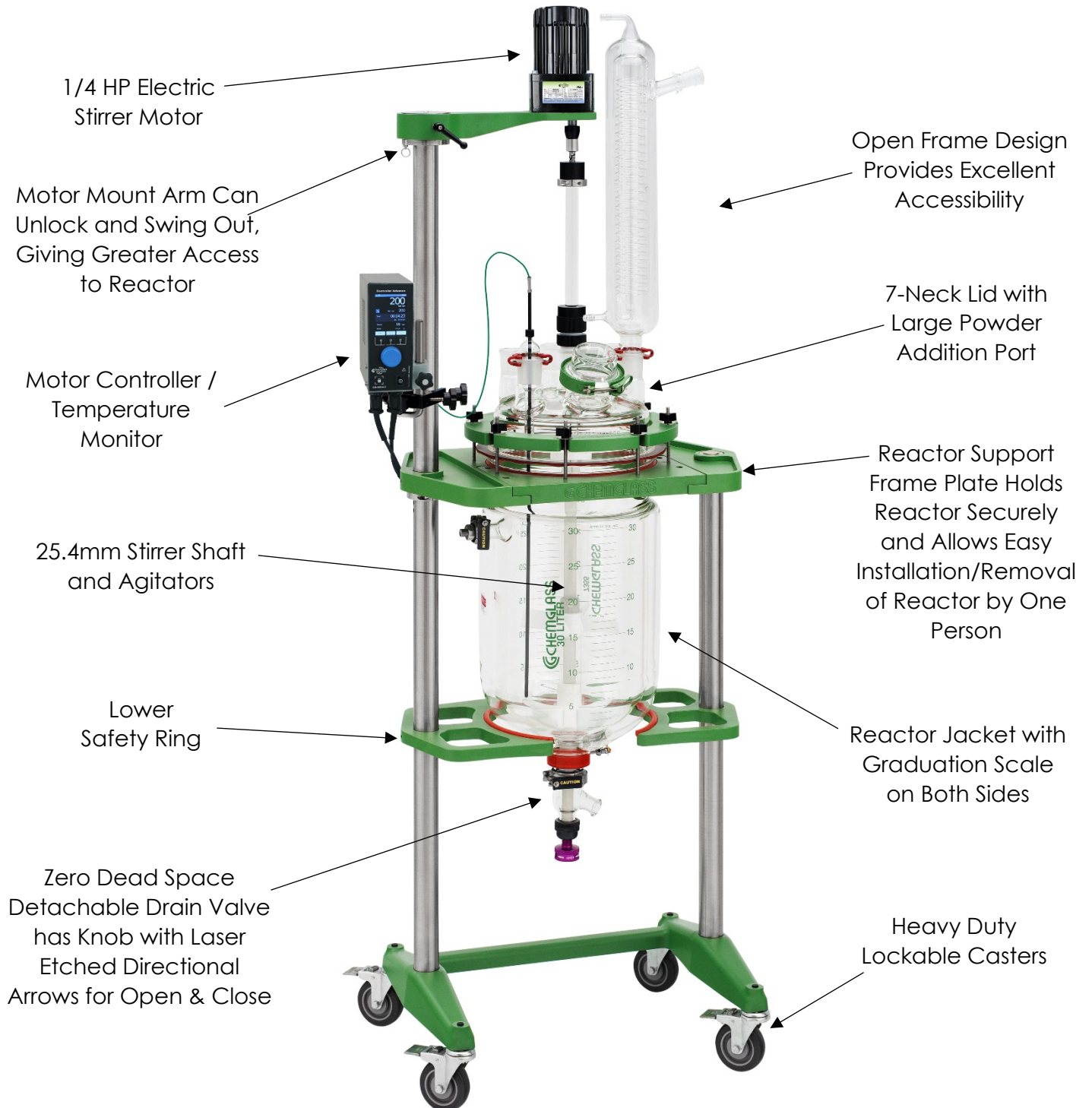

Read Entire Assembly Instructions Before You Begin. Familiarize Yourself with All of the Parts, and Pay Close Attention to All Notes and Highlights.

Support frames are shipped via common carrier and require loading dock access with a fork lift or jack. If you do not have a loading dock, then a lift gate-equipped truck must be requested at the time of order.

For your convenience, the jacketed process reactor, the fully assembled reactor head, stirrer shaft & agitators, Tru-Stir™ stirrer shaft coupling, flake catching cup, PTFE stirrer bearing, temperature probe & adapter, S.S. inlet/outlet adapters and motor are shipped assembled on the support frame. PTFE sleeves and keck clips are available separately.

Unpack all of the parts and check against the packing slip to make sure you have received all necessary components. If possible, keep some of the packaging materials from the wood crates in case you need to return items for repair or replacement.

Crate # 1:

- Unpack the support frame with reactor and components by removing the packing material from around the reactor. Contains the 1/4 HP electric stirrer motor, condenser, zero dead space drain valve, temperature monitor/motor controller, and other miscellaneous parts. Retighten all of the Allen screws with the supplied wrenches. **CHECK ALL ALLEN SCREWS BEFORE PROCEEDING; SCREWS CAN LOOSEN DURING SHIPMENT.**

Move the reactor assembly and parts near the hood or area where the reactor will be used, but allow enough space to move freely around the support frame. During setup, preparation, and process, it is best to keep the wheels in their locked position by stepping down on the tab.

Motor Mount
Arm

CG-2046
Stirrer Shaft
Coupling

Universal Motor Mount Arm

The universal motor mount arm can unlock and swing out giving greater access to the reactor and peripheral glassware.



Overhead Stirrer Motor



Air Motor



1/4 HP Vertical Motor



1/4 HP Horizontal Motor



Explosion Proof (XP) Motor

The motor is installed on the support frame when shipped. Use the following instructions should you need to remove or adjust these components.

Components Needed for Overhead Stirrer Motor:

1ea	CG-2033-B-25	1/4 HP Vertical Electric Stirrer Motor
1ea	CG-2033-B-27	1/4 HP Horizontal Electric Stirrer Motor
1ea	CG-2025-20	Air Motor* (Optional)
1ea	CG-2033-V-75	Motor Controller/Temperature Monitor (Only Supplied with 1/4 HP Electric Stirrer Motor)
1ea	CG-2046-90	Universal Stirrer Shaft Coupling
1ea	CG-9253-20	Large Kwik Klamp II
1ea	CG-3498-03	90° Support Rod

1. The support frame has a universal motor mount. It can be used with an (vertical or horizontal) electric, air, or optional explosion proof (XP) motor. The mount automatically centers the motor directly above the reactor.
2. Attach the 1/4 HP electric motor via four socket head cap screws. Screws are shipped installed on the motor.
3. Attach the universal stirrer shaft coupling to the motor shaft.
4. When using the 1/4 HP electric motor, the digital controller, with mounting bracket on side panel, needs to be mounted on the S.S. upright. Use the large Kwik Klamp II and the 90° S.S. support rod to mount the controller to the support frame. Tighten all knobs securely.

*The Air Motor requires the air supply be filtered and a lubricator be installed between the air source and motor. Filter-Regulator-Lubricator (CG-2025-10) is available separately.

Stirrer Shaft and Agitator Assembly

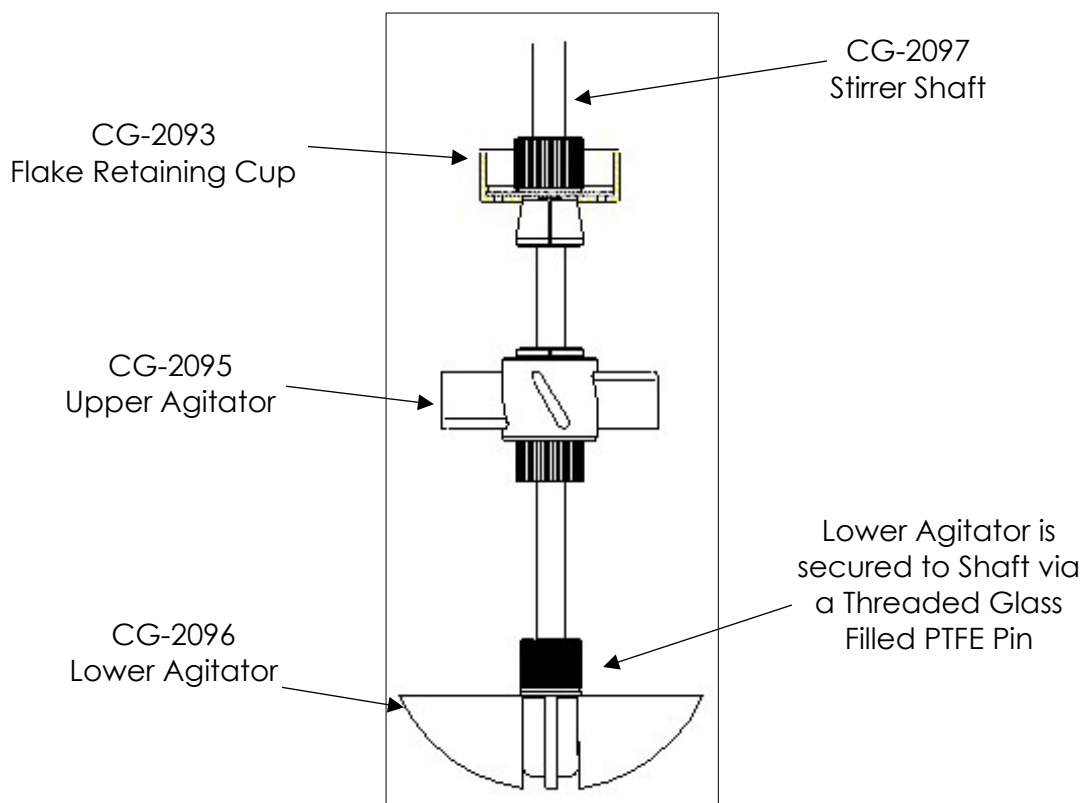

The stirrer shaft and agitators are assembled and installed when shipped. Use the following instructions should you need to remove or adjust these components.

Components Needed for Stirrer Shaft and Agitator Assembly:

- 1ea CG-2097 Stirrer Shaft
- 1ea CG-2093 Flake Retaining Cup
- 1ea CG-2095 Upper PTFE Agitator
- 1ea CG-2096 Lower High Viscosity PTFE Agitator

1. The lower agitator assembly (CG-2096) is placed on the end of the stirrer shaft aligning the hole on the stirrer shaft with the holes in the PTFE hub. The sand blasted portion is the lower end of the stirrer shaft. Insert the threaded glass filled PTFE pin. Tighten the compression fitting. PLEASE NOTE: THE PTFE PIN MUST BE INSTALLED BEFORE USING.
2. The upper agitator assembly (CG-2095) slides over the end of the shaft. The height from the bottom will depend on the total volume you intend to run in the reactor.
3. Once you have the upper agitator in place, tighten the compression fitting as tight as possible (by hand). For use at higher temperatures, Chemglass recommends heating the upper agitator hub with a heat gun and then retightening. Then tighten the set screw on the flat of the stirrer shaft using a screwdriver. This will minimize the possibility of the agitator falling or slipping at higher temperatures.
4. The PTFE flake retaining cup (CG-2093) slides over the top of the stirrer shaft and is positioned approximately 24 inches from the bottom of the lower agitator assembly (CG-2096). For the cup to work effectively, the final position will have to be adjusted so that it is not less than 1 inch away from the bottom of the PTFE stirrer bearing.

Inlet/Outlet Jacket Connections



The stainless-steel adapters are assembled and attached when shipped. Use the following instructions should you need to remove or adjust these components.

Components Needed for Inlet/Outlet:

2ea CG-1969-A S.S. Adapters, 1" Beaded Pipe to M16x1.0 Male or M30 x 1.5 Male
2ea CG-1968-66 1" Beaded Pipe Couplings

1. Reactor jacket comes standard with 1" glass beaded pipe on the inlet/outlet.
2. Loosen the nut on the beaded pipe coupling. Wet the PTFE/Viton liner inside the coupling and attach one side to the 1" beaded pipe on the jacket.
3. Insert the beaded pipe adapter (CG-1969-A) into the other side of the coupling.
4. Tighten the 1" beaded pipe coupling to 35in-lbs using a torque wrench.

MAX JACKET PRESSURE = 12 PSI ON 30L JACKETED REACTOR CG-1968-61
MAX JACKET PRESSURE = 12 PSI ON 50L SHORT JACKETED REACTOR CG-1968-95
MAX JACKET PRESSURE = 12 PSI ON 50L TALL JACKETED REACTOR CG-1968-81
MAX Δ T = 60°C
TEMPERATURE RANGE = -60 to 200°C

The Chemglass High Flow Manifold System alleviates excessive mechanical forces on the inlet/outlet and prevents over pressurizing with a pressure relief valve. This manifold is available separately, see CG-1969-M.



Zero Dead Space Drain Valve



WARNING: PLEASE NOTICE TEMPERATURE LIMITATIONS ON O-RINGS LISTED BELOW BEFORE USING THIS VALVE. PLEASE USE THE CORRECT O-RING FOR THE TIP BASE ON YOUR APPLICATION TEMPERATURE.

<u>O-Ring Material</u>	<u>Color</u>	<u>Temp Range (°C)</u>
Perfluoro	Black or White	-7 to 230
FEP-Silicone	Orange	-62 to 205

Components Needed for Zero Dead Space Drain Valve:

- 1ea CG-1968-GL-040 Zero Dead Space Drain Valve
- 1ea CG-1968-67 2" Beaded Pipe Coupling

1. Loosen the nut on the 2" beaded pipe coupling (CG-1968-67). Wet the PTFE/Viton liner inside the coupling and attach on side to the 2" beaded pipe drain valve seat on the reactor.
2. Attach the drain valve assembly (CG-1968-GL-040) to the other side of the coupling. **PLEASE NOTE: PLUG MUST BE IN THE OPEN POSITION. AFTER ASSEMBLY, BE SURE THE PLUG IS IN THE CLOSED POSITION PRIOR TO FILLING THE REACTOR.**
3. Tighten the 2" beaded pipe coupling to 60in-lbs using a torque wrench.

BEFORE YOU START:

The reactor is now ready for use. Before filling the reactor, make sure the zero dead space drain valve is in the closed position. Once setup is complete, the reactor can be moved into position and connected to the circulator. Keep the wheels locked for added safety.

Chemglass presumes some knowledge of this type of equipment on the part of the end user. Properties such as mechanical strength of glass, thermal stress introduced to the reactor from exothermic reactions, allowable temperature differentials, pressure and vacuum must all be considered with extreme caution.

If you have any questions, please contact our technical service department at (800) 843-1794 or technical-service@cglifesciences.com.

Optional Components:



Mechanical Seal Stir Bearing

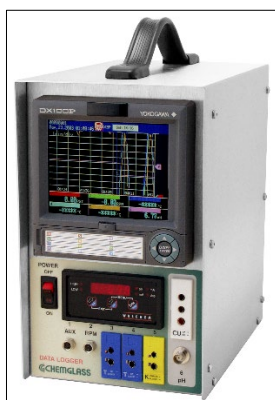

Data Logger



Powder Addition Funnel



Distillation Side Support Shelf

Complete Assembly Instructions

The jacketed process reactor, the fully assembled reactor head, stirrer shaft & agitators, stirrer shaft coupling, flake retaining cup, PTFE stirrer bearing, temperature probe & adapter, S.S. inlet/outlet adapters, motor and motor mount arm are shipped assembled on the support frame. (All joints must be properly greased to avoid "freezing" and improve vacuum. PTFE sleeves and keck clips are available separately.) Use the following instructions should you need to remove or adjust these components.

1. Attach the zero dead space drain valve (CG-1968-GL-040) to the reaction vessel via the 2" beaded pipe coupling (CG-1968). Tighten the coupling to the specified torque setting.
2. Attach the S.S. beaded pipe adapters (CG-1969-A) to the inlet/outlet of the reaction vessel via the 1" beaded pipe coupling (CG-1968). Tighten the coupling to specified torque setting. **PLEASE NOTE: IF YOU ELECT TO USE THE CG-1969-M HIGH FLOW MANIFOLD SYSTEM, THIS NEXT STEP CAN BE SKIPPED.**
3. Carefully lower the reaction vessel into the support frame and rest the bottom of flange on the red silicone tubing. Slide front reaction vessel plate tight against the reactor and tighten the plate via the four Allen screws (Figure A).
4. Place the PTFE envelope gasket on the flange of the reaction vessel.
5. Assemble the stirrer shaft, agitators, and PTFE flake retaining cup, and lower into the reaction vessel.
6. While lowering the reaction vessel lid onto the vessel, carefully insert the end of the stirrer shaft through the center neck of the lid. **PLEASE NOTE: THE PTFE STIRRER BEARING IS NOT INSERTED AT THIS TIME.**
7. Dismantle then slide the PTFE stirrer bearing over the end of the stirrer shaft and "press" into the center neck, sealing the o-ring.
8. Position the powder fill port towards the front of the reactor.
9. Secure the vessel and lid together with the clamp ring, making sure the entire PTFE envelope gasket is seated evenly on the flange. Tighten the wing nuts in a star pattern (Figure B). Work your way around the entire clamp until you have repeated this 3-4 times and all the wing nuts are tight. **DO NOT OVER TIGHTEN.**
10. Attach the universal stirrer shaft coupling to the 1/4 HP electric stirrer motor shaft. Then attach the motor to the support frame via the supplied four socket head cap screws.
11. Insert the end of the stirrer shaft into the coupling and tighten the collar with an Allen wrench. Check the vertical alignment of the reactor and adjust if necessary.
12. Tighten the black compression nut on the PTFE stirrer bearing, which compresses the bearing onto the stirring shaft.
13. Attach the motor controller/temperature monitor to the support frame via the large Kwik Klamp II and 1/2" OD 90° support rod.
14. Attach the control cord from the electric stirrer motor to the bottom panel of the controller. Make sure the speed control knob on the controller is turned completely off **BEFORE** turning the controller on. If using the air motor, attach the air source to the motor. The brass needle valve on the back of the air motor should be **CLOSED**.
15. Loosen the compression nut then insert the thermocouple through the thermocouple adapter and the insert the adapter into the desired side neck. Adjust the depth of the thermocouple by tightening the chem-thread at the top of the adapter. **PLEASE NOTE: CHECK TO SEE THAT THE THERMOCOUPLE DOES NOT COME INTO CONTACT WITH EITHER AGITATOR BY MANUALLY TURNING THE STIRRER SHAFT.** Attach the thermocouple cord to the probe then to the temperature monitor.
16. Attach condensers and any other peripheral glassware.

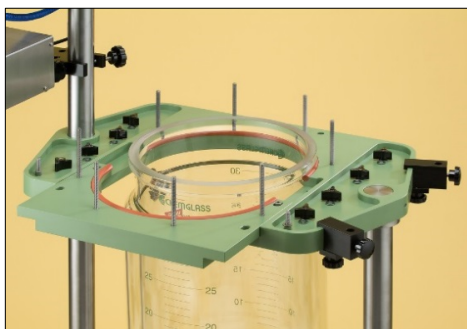

Figure A

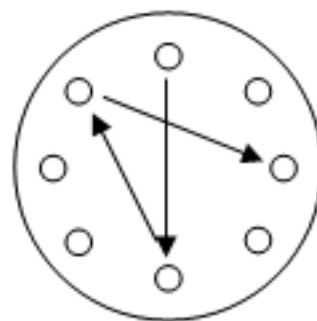

Figure B

JACKETED REACTORS, 30L

30L PROCESS REACTOR, CYLINDRICAL, JACKETED, ELECTRIC OR AIR MOTOR

Complete reactor system on our NEW open air stand. Supplied with the components listed below and numbered on the schematic drawing. Optional items are listed on the following pages. **PLEASE NOTE: REACTOR STAND OVERALL HEIGHT WITH MOTOR AND CLEARANCE BELOW VALVE, ARE CALCULATED FOR ALL CHEMGLASS STIRRER BEARINGS, INCLUDING THE CG-2077-M MECHANICAL SEAL STIR BEARING.**

30L COMPLETE PROCESS REACTORS:

Part Number	Description	Motor Type	Approx. Overall Height W/ Motor (in)	Clearance Below Valve (in)
CG-1968-630	30L Process Reactor, Complete	Electric	82.6	18.6
CG-1970-630	30L Process Reactor, Complete	Air	79.0	18.6

COMPLETE WITH CG-1969-M-06 MANIFOLD WITH M30 CIRCULATOR FITTINGS

Part Number	Description
CG-1968-630M	30L Process Reactor, Complete, Electric
CG-1970-630M	30L Process Reactor, Complete, Air

Standard Components Supplied With Complete Process Reactors:

No.	Part No.	Description
1	CG-1215-C-10	High Efficiency Condenser, 45/50
2	CG-2097-31	25.4mm Stirrer Shaft, 41-7/8" OAL
3	CG-2077-H-06	25.4mm PTFE Stir Bearing
4	CG-149-06	80mm Glass Cap
5	CG-141-T-10	80mm S.S. Clamp, PTFE Coated
6	CG-147-79	80mm FEP Encased S.S. Spring O-Ring
7	CG-1968-G-01	300mm Envelope Gasket
8	CG-1968-61	30L Jacketed Reaction Vessel
9	CG-1969-A-05	S.S. Adapter, 1" Beaded Pipe to M16 X 1 Male (2ea)
10	CG-1968-66	1" Beaded Pipe Coupling (2ea)
11	CG-1968-67	2" Beaded Pipe Coupling
12a	CG-2033-B-50	Electric Stir Motor, 1/4Hp, 500 RPM
12b	CG-2025-20	Air Motor, 3/8Hp
12c	CG-2025-10	Filter-Regulator-Lubricator (Air Motor Only)
13a	CG-2046-90	25.4mm Shaft Coupling, (Electric)
13b	CG-2046-91	25.4mm Shaft Coupling, (Air)
15	CG-2033-V-75	Stir Motor Controller (Electric Only)
17	CG-3498-03	1/2" OD Rod, 90° Bend (2ea)
18	CG-9253-20	Universal Kwik Mount Klamp (2ea)
19	CG-1042-E-10	Thermocouple Adapter, 45/50
20	CG-1968-A-01	7-Neck Lid, 300mm
21	CG-2093-21	PTFE Flake Catching Cup, 25.4mm
22	CG-1978-P932	PT100 Temp. Sensor, 1/4" Diameter x 32" Long
23a	CG-2095-23	8" OD PTFE Agitator, 60°
23b	CG-2096-12	10" OD PTFE Agitator, High Viscosity
24	CG-1968-X-12	New Open Support Frame, 75.25" OAH
25	CG-1968-GL-040	Zero Dead Space Drain Valve
--	CG-3002-L-45	45/50 PTFE Stopper With Loosening Ring (2ea)
--	CG-145-09	45/50 Keck Clips (PK10)
---	CG-2048-03	25.4mm Safety Collar with PTFE Gasket
---	CG-1963-B-10	Beam Torque Wrench
---	CG-1963-B-14	7/16" Deep Socket, 6 Point, 1/4" Drive

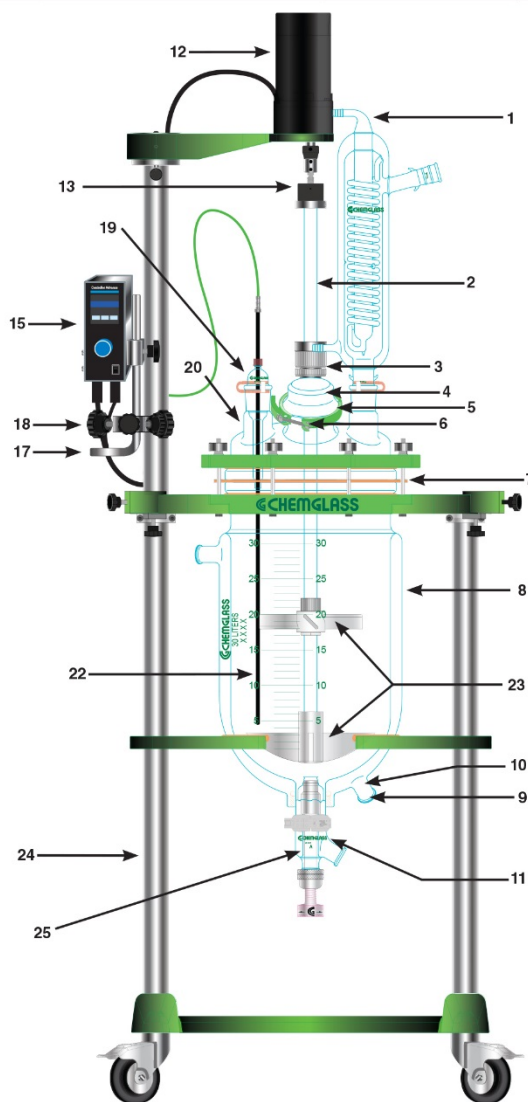

JACKETED REACTORS, 50L

50L PROCESS REACTOR, CYLINDRICAL, JACKETED, ELECTRIC OR AIR MOTOR

Complete reactor system on our NEW open air stand. Supplied with the components listed below and numbered on the schematic drawing. Optional items are listed on the following pages. **PLEASE NOTE: REACTOR STAND OVERALL HEIGHT WITH MOTOR AND CLEARANCE BELOW VALVE, ARE CALCULATED FOR ALL CHEMGLASS STIRRER BEARINGS, INCLUDING THE CG-2077-M MECHANICAL SEAL STIR BEARING.**

Part Number	Description	Motor Type	Approx. Overall Height W/ Motor (in)	Clearance Below Valve (in)
CG-1968-650	50L Process Reactor, Complete	Electric	90.8	16.2
CG-1970-650	50L Process Reactor, Complete	Air	87.3	16.2

COMPLETE WITH CG-1969-M-06 MANIFOLD WITH M30 CIRCULATOR FITTINGS

Part Number	Description
CG-1968-650M	50L Process Reactor, Complete, Electric
CG-1970-650M	50L Process Reactor, Complete, Air

Standard Components Supplied With Complete Process Reactors:

No.	Part No.	Description
1	CG-1215-C-10	High Efficiency Condenser, 45/50
2	CG-2097-53	25.4mm Stirrer Shaft
3	CG-2077-H-06	25.4mm PTFE Stir Bearing
4	CG-149-06	80mm Glass Cap
5	CG-141-T-10	80mm S.S. Clamp, PTFE Coated
6	CG-147-79	80mm FEP Encased S.S. Spring O-Ring
7	CG-1968-G-01	300mm Envelope Gasket
8	CG-1968-81	50L Jacketed Reaction Vessel
9	CG-1969-A-06	S.S. Adapter, 1" Beaded Pipe to M16 x 1.5 Male (2ea)
10	CG-1968-66	1" Beaded Pipe Coupling (2ea)
11	CG-1968-67	2" Beaded Pipe Coupling
12a	CG-2033-B-50	Electric Stir Motor, 1/4Hp, 500 RPM
12b	CG-2025-20	Air Motor, 3/8Hp
12c	CG-2025-10	Filter-Regulator-Lubricator (Air Motor Only)
13a	CG-2046-90	25.4mm Shaft Coupling, (Electric)
13b	CG-2046-91	25.4mm Shaft Coupling, (Air)
15	CG-2033-V-75	Controller, Motor, Temp. and Time (Electric Only)
17	CG-3498-03	1/2" OD Rod, 90° Bend (2ea)
18	CG-9253-20	Universal Kwik Mount Klamp (2ea)
19	CG-1042-E-10	Thermocouple Adapter, 45/50
20	CG-1968-A-01	7-Neck Lid, 300mm
21	CG-2093-21	PTFE Flake Catching Cup, 25.4mm
22	CG-1978-P945	PT100 Temp. Sensor, 1/4" Diameter x 45" Long
23a	CG-2095-23	8" OD PTFE Agitator, 60°
23b	CG-2096-12	10" OD PTFE Agitator, High Viscosity
24	CG-1968-X-14	New Open Support Frame, 83.50" OAH
25	CG-1968-GL-040	Zero Dead Space Drain Valve
--	CG-3002-L-45	45/50 PTFE Stopper With Loosening Ring (2ea)
--	CG-145-09	45/50 Keck Clips (PK10)
---	CG-2048-03	25.4mm Safety Collar with PTFE Gasket
---	CG-1963-B-10	Beam Torque Wrench
---	CG-1963-B-14	7/16" Deep Socket, 6 Point, 1/4" Drive

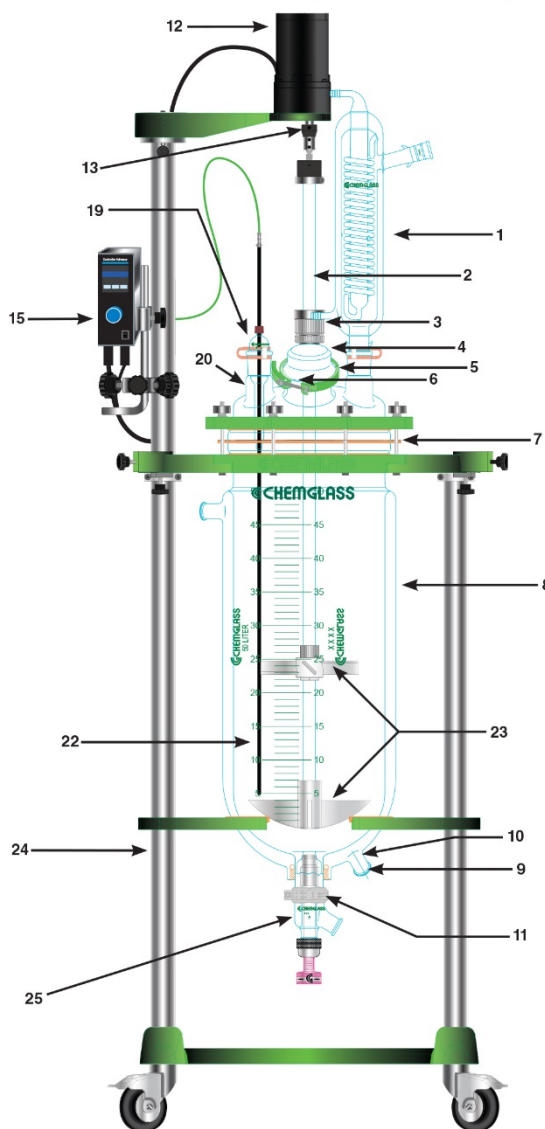

Optional Components:



Distillation Cart System



Distillation Side Support Shelf

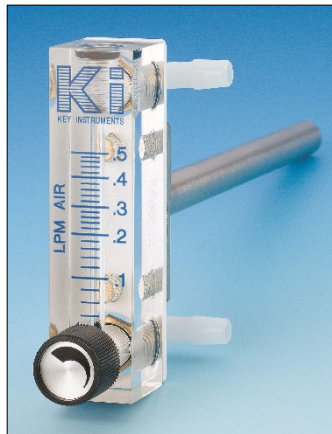

Flowmeter



Mechanical Seal Stir Bearing



Powder Addition Funnel



Data Logger

CG-1978-P, CG-1979-P and CG-3498 Probes for Reactor Systems Installed in Hazardous/XP or ATEX environments.

Chemglass PT100 and thermocouple probes that will be used in a hazardous/explosion proof area must be used with a Zener barrier.

Zener barriers are used in control and instrumentation systems for the process of standardized signals, such as 20 mA or 10 V. Zener barriers contain intrinsically safe circuits that are to be used to drive intrinsically safe field devices with hazardous area. The manufacturer's data sheets must be consulted. The relevant regulations and directives governing the intended application must be followed. Zener barriers must be installed in conformance with the National Electrical Code. Please check with your company/university.

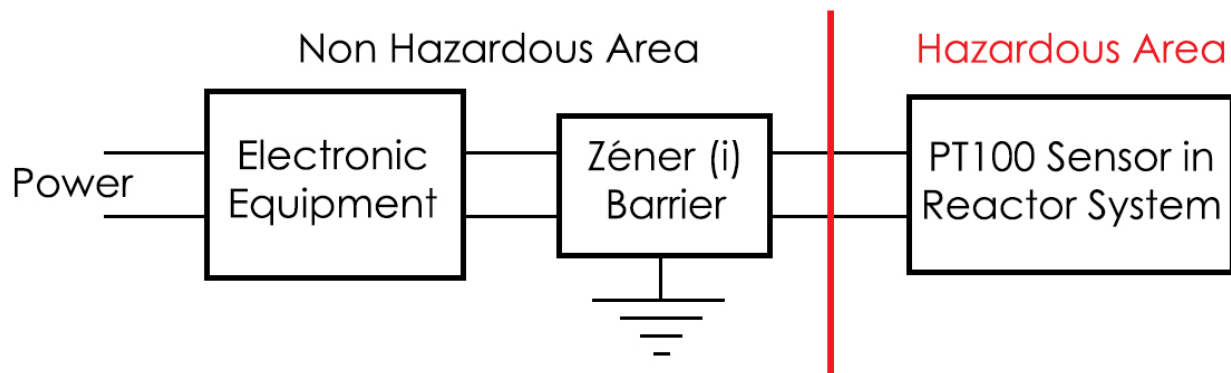

3800 North Mill Road, Vineland, NJ 08360
US & Canada Phone: (800) 843-1794 International: (856) 696-0014
US & Canada Fax: (800) 922-4361 International: (856) 696-9102

REV_AUGUST_2019