

THE JAPANESE
KITCHENWARE &
TABLEWARE



FOR WORLD-RENOWNED JAPANESE CUISINE.

KYS PROVIDES A RANGE OF PROFESSIONAL COOKING IMPLEMENTS.

Japanese food is delicious and has exceptional nutritional value. It continues to be highlighted around the world. Japanese food is known for its seasonal ingredients, which are delicately prepared by skilled chefs to maximise flavour and allow the customer to enjoy their food with their eyes as well as their taste buds.

KYS provides high-quality Japanese-made kitchen knives, with exceptional edges, which are prized by chefs around the world. We also provide kitchenware that enables chefs to directly express their vision, and tableware in a variety of colours to present delicate dishes to maximum effect.

People are smiling and enjoying gourmet food... This is the scene that we keep in mind while providing you with high quality items that are exceptionally "safe" and easy to use.



JAPANESE KNIFE

1 ~ 26

KITCHEN WARE

31 ~ 61

TABLE WARE

62 ~ 86

A	Apple peeler	52	G	Guinomi series	84
B	Bamboo strainer	35		Gyutou	11-21, 24-26
	Bar spoon	66, 79	H	Hagi sudare	69
	Bento box	81-83		Hanabashi	39
	Bones pot	70		Hand brush	30
	Boning knife	11, 12		Handy jug	61
	Bonito shaver	34		Honesuki	11, 12
	Bottle keeper	66	I	Ice crusher	60
	Burner set	72, 73		Ice crusher&shaver	60
C	Cabbage slicer	49		Ice flag	61
	Carving fork	9		Ice mold	68
	Carving knife	9		Ice pail	66
	Caster tray	63		Ice pail tongs	66
	Cedar steamer	41		Ice pail mat	66
	Charcoal burner	74		Ice picker	61
	Charcoal starter	53		Ice scoop	61
	Charcoal starter stove	53		Ice shaver	59, 60
	Charcoal tongs	53		Ice tongs	43
	Chashao(Roast pork) tongs	43		Icecream disher	61
	Chawan mushi spoon	78, 79		Information plate	85
	Chef's knife	11-21, 24-26	J	Japanese traditional knife	1-9
	Chinese style cleaver	9		Jigger	66
	Chochin	86		Julienne machine	50
	Chopsticks	77	K	Kakiage ring	40
	Chopsticks case	63, 64		Kamagata Usu ba	6
	Chopsticks rest	77		Kasuage mesh skimmer	40
	Clam knife	48		Katsuramuki	51
	Colander	35		Kitchen pot	35
	Condiment dispenser	35		Kitchen scissors	44
	Cooking chopsticks	39		Kneading bowl	38
	Cooking paper	80		Knife	1-26, 78, 79
	Cooking pot	32		Knife stocker	30
	Copper egg pan	47		Konro set	72, 73
	Crab fork	70	L	Ladle	42
	Curry pot	75		Ladle for wok pan	33
	Curry souce ladle	75		Lantern	86
	Cushion	85		Leek slicer	50
	Cutlary	78, 79		Lemon sqweezer	61
	Cutlet net	69		Lemon tongs	43
	Cutting board	29		Lid	32
	Cutting board stand	30		Lid for egg pan	47
D	Dashikoshi fukuro(bag)	34		Lobster cracker	70
	De ba	3-7		Lye remover	70
	Decoration vat	68	M	Makisushi	47
	Dehydrating sheet	80		Makisushi cutter	46
	Dish for meat	70		Makunouchi bento box	83
	Dispenser	43		Manabashi	39
E	Earthen pot	54		Menu book	65
	Edo bitsu	46		Menu book stand	63, 64
	Edo saki	9		Mesh skimmer	70
	Eel ripping knife	9		Milk pan	32
	Egg cutter	48		Mincer	53
	Egg pan	47		Miso soup warmer	56
	Egg tofu mold	41		Miso strainer	34
F	Fire extinguish pot	53		Muddler	66, 79
	Fish bone tweezer	48		Multi purpose knife	12-15, 20, 21, 23
	Fish grill	54		Multilingual plate	85
	Fork	78, 79	N	Napkin stand	63
	Fruits knife	11-13, 17-21, 23-26		Negi slicer	50
	Frying pan	33		Net	54
G	Gari pot	64		Noodle making machine	38
	Gari tongs	43		Noodle stick	38
	Garnish cutter&slicer	52		Noodle strainer	37
	Ginger pickles pot	64		Noren	86
	Ginkgo nut splitter	44		Nori box	47
	Grapefruit sqweezer	61		Nori drier	47
	Grater	43		Nuki ita	46
	Grater machine	50	O	Oden warmer	56
	Grater machine	50		Oil filter	40
	Green onion slicer	50		Oil pot	40
	Grill plate	72			
	Grinding bowl	44			
	Grinding stick	44			

CONTENTS

O	Oiling brush set	80	S	Soy sauce pot	63
	Onigiri mold	45		Spaghetti strainer	37
	Oyako pan	33		Spatula	35
	Oyster knife	48		Special knife	9
P	Paper pot	71		Spike for eel	48
	Paring knife	11-13, 17-21, 23-26		Spoon	70, 75, 77-79
	Peeler	44		Steak plate	75
	Peeling knife	9		Steamer	41
	Peking wok pan	33		Steamer set	73
	Pepper pot	63, 64		Steaming cloth	41
	Petit pan	75, 76		Stock pot	35
	Petit pan chinese style	76		Strainer	34, 35, 37, 61
	Petty knife	11-13, 17-21, 23-26		Sujihiki	11-13, 17-21, 24-26
	Pichitto	80		Sukiyaki pot	73
	Pick fork	77		Sumibitei	74
	Pillow for sashimi	69		Suribachi	44
	Pineapple slicer	52		Sushi boat	67
	Pot	71, 72		Sushi brush	80
R	Radish grater machine	50		Sushi case	58
	Ramen spoon	77		Sushi cutter	9, 46
	Ramen strainer	37		Sushi geta	67, 68
	Red cayenne pepper pot	64		Sushi mat	47
	Red keeper	80		Sushi mold	45
	Refillable strainer	42		Sushi oke	46
	Rice container	36		Sushi rice jar	55
	Rice cooking net	56		Sushi tub	46, 68
	Rice jar	55		Sushikiri	9
	Rice mold	45	T	Tako hiki	6
	Roast net	44		Tea strainer	61
	Rolling sharpener	27		Tempura lees pot	40
S	Saibashi	39		Tempura paper	69
	Sake carafe	84		Tempura pot	39
	Sake glass	84		Tempura thermometer	39
	Sake thermometer	57		Tempura tongs	43
	Sake warmer	57		Tempura vat	39
	Sake warmer dispenser	57		Thermal rice container	36
	Salt pot	63		Thermal rice jar (container)	55
	Santoku	12-15, 20, 21, 23		Thermal soup warmer	56
	Sanuki tamo	37		Thermometer	39, 57
	Sashimi case	58		Tokkuri	84
	Sashimi knife	3-7		Tongs	42, 43, 66
	Sauce brush	80		Tonkatsu net	69
	Sauce pot	63		Toothpick pot	63, 64
	Sauce pot (okonomiyaki)	80		Towel warmer	61
	Sauce pourer for eel	54		Tray	64
	Scaler	48		Tsumakiri	51
	Scissors	44		Tuna paper	80
	Scorch remover	30		Turner (okonomiyaki)	80
	Scrubber	80	U	Udon strainer	37
	Seasoning pot	63, 64		Udonsuki pot	71
	Seaweed box	47		Usu ba	3-7
	Seaweed drier	47	V	Vat	36
	Separate paper	41		Vegetable cutters	44
	Serving spoon	70, 79		Vegetable peeler	44
	Serving spoon stand	70		Vegetable slicer	49-52
	Sesame grinder	63		Venriner	52
	Shabu shabu pot	71	W	Wasabi grater	43
	Sharpening steel bar	27		Water jug	61
	Sharpening stone	27		Water konro	74
	Shokado bento box	81-83		Water pitcher	61, 66
	Shrimp fork	70		Western style Deba	11, 12
	Sieve	34		Western style knife	10-26
	Sign plate	85		Whetstone	27
	Skewer	54		Wok pan	33
	Slicing knife	11-13, 17-21, 24-26		Wok pan cleaner	33
	Smoke wood	53		Worcester pot	63
	Soba buckweat flour brush	38	Y	Yakumi pan	35
	Soba knife	9		Yanagi ba	3-7
	Soba seiro	83		Yattko pincer	32
	Soba strainer	37		Yattko pot	32
	Soba tsuyu bowl	83		Yo Deba	11, 12
	Sobayu pitcher	83		Yolk separator	48
	Soup filter	34		Yukihira pot	32
	Soup ladle	42			
	Soup warmer	56			



JAPANESE KNIFE

The Japanese kitchen knife that traditional technique and feelings breathe.

The Japan's three biggest production center.

日本三大産地

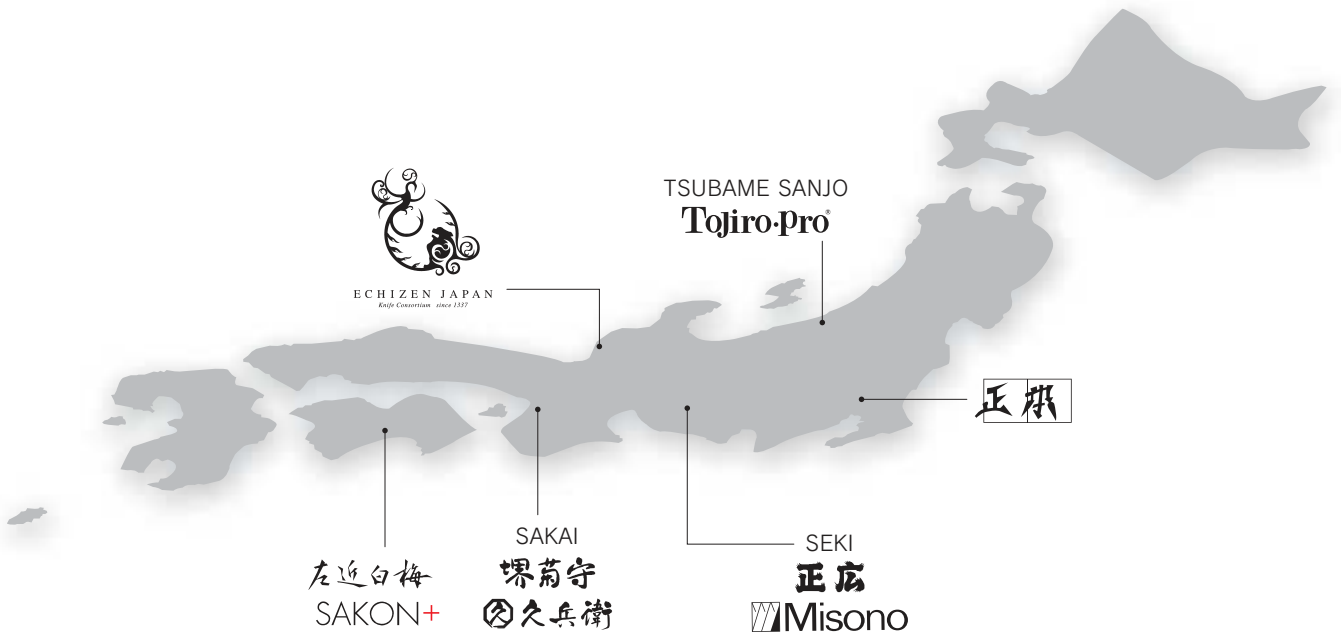

堺 Sakai

The skill of forging steel first came to Sakai in the 5th century, during the Kofun period. The Kofun period is when kings had hook-shaped monuments built as their tombs. Like the pyramids of Egypt, the size of the tomb was representative of the king's power, and kings competed to have the biggest tomb. About A.C.50, the massive tomb of the emperor, Nintoku, was built, and blacksmiths from around Japan gathered to build hoes and spades for the project. Since then, Sakai has been at the center of Japanese metal manufacturing. Since the end of the Heian period, Sakai has been involved in sword making, and during the Sengoku period, it became a production center for rifles that had been introduced by the Portuguese. Sakai's technological capabilities were rated so highly that those in power at the time competed to place it under their control. During the Edo period, the Tokugawa Shogunate recognized the quality of Sakai's tobacco knives, and in order to differentiate them from knives produced in other regions, it released a special seal (the Sakai seal) to mark genuine Sakai products, and the sharpness and reputation of Sakai products soon spread throughout Japan. This skill has been passed down from generation to generation, and at present, Sakai knives are designated by the Minister of Economy, Trade and Industry as a traditional craft.

The manufacturing processes of knives produced in Sakai can be broadly classed as forging, grinding the blade, and attaching the handle. Specialist artisans are in charge of each of these 3 processes. The high skill level, as well as the time and effort invested by many craftsmen lends these knives the beauty of a work of art, along with an exceptional cutting edge. These products are highly rated around the world; however it is extremely difficult to produce them in large quantities.

関 Seki

About 780 years ago, during the Kamakura period, the sword smiths of Kyushu, Motoshige, sought the type of iron that was suitable for making blades, as well as the high quality water and clay that was necessary to quench them. Motoshige settled in Seki, and began to make Japanese swords. Since then, Seki has produced numerous master smiths, and it became known as the sword capital of Japan. In addition to the high level of skill involved in the manufacture of Seki swords, Seki swords were also prized by many military commanders for their superior utility and because 'they do not break or bend, and they cut well.' Since the Meiji restoration, the focus has shifted from sword smithing to the manufacture of more practical items, such as knives, scissors, pocket knives, and shavers. At present, Seki not only manufactures knives for the Japanese market, but it also exports to America, Europe, and around the world, and it has a reputation as a knife producing region that is equivalent to that of Solingen in Germany. Seki knives incorporate new technology and materials while building on a base of traditional craftsmanship and its western knives are particularly highly rated. Each company has an integrated production process, which includes forging, shaping the blade, and attaching the handle.

燕三条 Tsubame Sanjo

Blade production has long formed the core of local industry in Sanjo city. In the early part of the Edo period, the area surrounding Sanjo city was actively engaged in the development of new farmland, and blade production techniques were developed to meet the corresponding demand for farming implements such as sickles and hoes. In addition, the neighboring Tsubame area began production of cutlery in the Meiji period. Since the Showa period, in particular, stainless steel products have been at the height of their popularity, and Tsubame Sanjo has become a global production center for stainless steel cutlery and kitchen tools. The blade producers in the Tsubame Sanjo region specialize in stainless steel knives and new knife designs, and are increasing their market share.

Japanese Style knife construction is broadly divided into the categories of 'honyaki' and 'kasumi'.

【 Honyaki 】

Honyaki knives are made from a single sheet of steel. They keep their cutting edge for a long time, and have minimal deformation due to sharpening. Because they are made from a single sheet of steel, Blue steel honyaki knives have a beautiful luster and blue steel honyaki knives are known as the highest quality of Japanese knife. However, the production process is difficult, and quality can be variable, and the extreme hardness can make them difficult and time consuming to sharpen and lead to chipping. For this reason, unless they are sharpened by an experienced craftsman, you will not be able to take advantage of their benefits and you will find them difficult to work with. At present, very few chefs use honyaki knives.

【 Kasumi 】

Kasumi knives are made by forge welding soft iron to the steel that forms the cutting portion of the blade, so that when the knife has been sharpened, the edge shines like a mirror and the soft iron portion is mat. Kasumi means mist in Japanese, and this name comes from the ripple pattern that is created by the join between the steel and the soft iron, which resembles mist. Among kasumi blades, those that use the highest quality steel are known as hon-kasumi. Compared to honyaki knives, the soft iron exterior of these knives makes these knives easier to sharpen and less prone to chipping. At present, a large proportion of the knives used by chefs in Japan are this type of knife.



Japanese Knife variation

Yanagi- ba (Sashimi Knife)



When cutting sashimi, if you slide the knife backwards and forwards, it damages the surface that has been cut, and the fish loses its sheen. This can be prevented by using a long knife that can be slid in one direction, from the hilt to the tip. This type of sashimi knife was originally used in the Kansai region, but it is now common throughout Japan.

Tako- hiki (Sashimi Knife)



These knives are designed for cutting sashimi. When cutting sashimi, if you slide the knife backwards and forwards, it damages the surface, and the fish loses its sheen. This can be prevented by using a long knife that can be slid in one direction, from the hilt to the tip. This type of sashimi knife was originally used in the Kanto region. It has a straight blade and the tip is flat, as though it has been cut short. It is slightly thinner than the yanagi-ba.

De-ba



These knives are used for breaking down fish and chickens etc. The blade is thick and heavy, which prevents it from bending when being used with effort.

Usu-ba



These knives are mainly used for cutting vegetables. The delicate cuts and beautiful shapes of vegetables cut with this knife are born from the knife's thinness. These knives are ideal for 'katsuramuki'.

Kamagata Usu-ba



This is the Kansai style of usu-ba. The spine curves downward towards the tip, and it can be used for a broad range of delicate work, such as 'katsuramuki' and 'tsuma', as well as peeling and fine chopping.



The Origins of KYUBEI

Kyubei began as a blacksmith's shop founded by Kyubei Kishi below Nagoya Castle, in the Owari domain, in the late 1700s, which was during the latter part of the Edo period. The shop continued to operate in Hisaya-cho for 6 generations through the Meiji restoration, however trading ceased due to the chaos created by the Pacific War. In August 1945, Yasuji Kishi (7th generation) founded the Kishiyasu store (currently Kishiyasu Corporation Ltd.), and resumed business as an ironmonger. However, during the rapid expansion of the Showa period, businesses began to transition into becoming kitchenware wholesalers geared towards the food service industry, and this business, which had been an iron foundry since its inception released the Kyubei brand of knives. To this day, the main office of the Kishiyasu Sangyou Co., Ltd. is located in the old foundry district (currently Marunouchi 3-chome, Naka-ku, Nagoya), and produces cast iron and other metal kitchen products for the national and global markets.

【 Hon-Kasumi Gokujo 】

Hon-Kasumi knives are Kasumi knives made with the highest quality steel.

In addition, the word 'Gokujo' indicates the highest quality in Japanese. When referring to the raw materials used to make knives, gokujo means knives made from Shiro-ni steel with minimal impurities and high carbon content for superior hardness and an exceptional cutting edge. These incredible material is then hand-forged and heat treated by traditional artisans to create hard yet durable blades with a superior edge that are easy to sharpen and are resistant to chipping.



Back Side



① KYUBEI Hon-Kasumi Gokujo Yanagi-ba

久兵衛 本齋 極上 柳刃

- 270mm : 31-0003-0101
- 300mm : 31-0003-0102



② KYUBEI Hon-Kasumi Gokujo De-ba

久兵衛 本齋 極上 出刃

- 150mm : 31-0003-0201
- 165mm : 31-0003-0202
- 180mm : 31-0003-0203
- 210mm : 31-0003-0204



③ KYUBEI Hon-Kasumi Gokujo Usu-ba

久兵衛 本齋 極上 薄刃

- 210mm : 31-0003-0301

技

KYUBEI

The gem that quality and the skill of the craftsman were put.

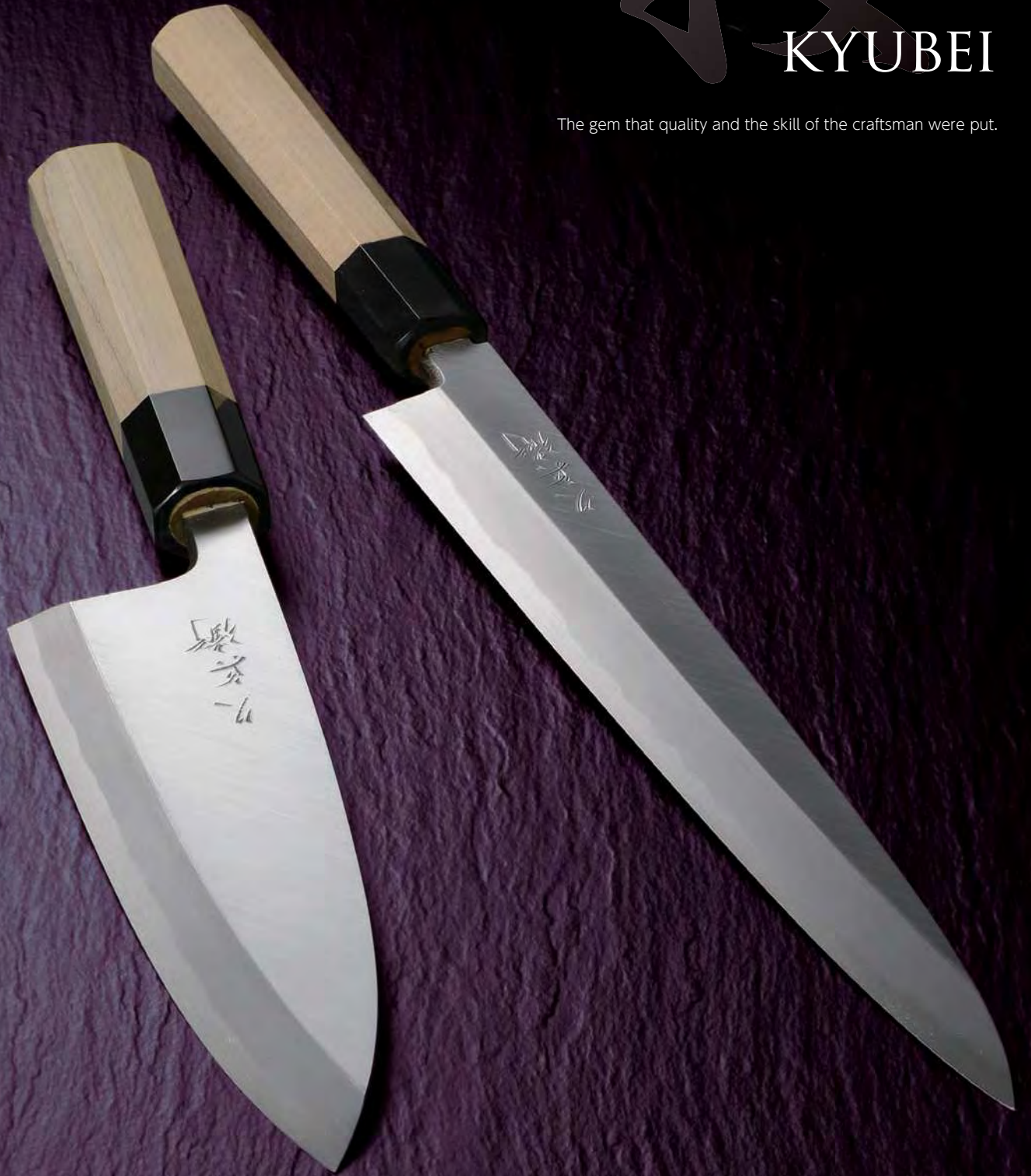

堺菊守

SAKAI KIKUMORI

Sakai knives boast superior edges, which are hand crafted by artisans, whose knowledge has been passed down over the company's 600-year long history. Sakai is a famous locale for knife production, both within Japan and around the world. In Japan, Sakai accounts for more than 90% of the professional high-quality knife market, and in 1982, it was designated by the government as a traditional craft. The Sakai Kikumori brand was born through the continuation of these traditional techniques along with the determination to introduce Sakai knives to many more people around the world through the incorporation of new technologies. Sakai KIKUMORI continues to conduct research and product development with the aim of providing superior knives, both within Japan and around the world, while contributing to the continuation of its extensive history.

【 Hon-Kasumi Gin-san Steel 】

Hon-Kasumi knives are Kasumi knives made with the highest quality steel. Gin-san steel is the type of stainless steel most suited to Japanese knives. It is stainless steel, which means it is resistant to rust, so it is preferred in humid or salty environments. It has a hardness of approximately 60, which is the same as Japanese carbon steel knives, which alleviates the inherent difficulty of sharpening stainless steel knives, while maintaining a sharp cutting edge, which is why this is the stainless steel knife that is preferred by professionals. Furthermore, most stainless steel knives are made by cutting the shape out of a steel sheet, however Gin-san steel is able to be hand forged, which makes it ideal for Japanese style knives, while also being chip resistant.



① SAKAI KIKUMORI Gin-san Yanagi-ba

堺菊守 本鋼 銀三鋼 柳刃

- 270mm : 31-0005-0101
- 300mm : 31-0005-0102



② SAKAI KIKUMORI Gin-san De-ba

堺菊守 本鋼 銀三鋼 出刃

- 150mm : 31-0005-0201
- 165mm : 31-0005-0202
- 180mm : 31-0005-0203
- 210mm : 31-0005-0204



③ SAKAI KIKUMORI Gin-san Usu-ba

堺菊守 本鋼 銀三鋼 薄刃

- 210mm : 31-0005-0301

堺菊守

[Kasumi Tokusei]

Tokusei knives are Kasumi knives made from Yasugi Shiro-san steel, with maximum impurities removed, forge welded to unprocessed soft iron. These knives are easy to sharpen and maintain, and for this reason, they are very popular amongst Japanese chefs. They are also comparatively reasonably priced.



① SAKAI KIKUMORI Kasumi Tokusei Yanagi-ba

堺菊守 霞 特製 柳刃

- 240mm : 31-0006-0101
- 270mm : 31-0006-0102
- 300mm : 31-0006-0103
- 330mm : 31-0006-0104



② SAKAI KIKUMORI Kasumi Tokusei Tako-hiki

堺菊守 霞 特製 蛸引

- 300mm : 31-0006-0201



③ SAKAI KIKUMORI Kasumi Tokusei De-ba

堺菊守 霞 特製 出刃

- 150mm : 31-0006-0301
- 165mm : 31-0006-0302
- 180mm : 31-0006-0303
- 210mm : 31-0006-0304



④ SAKAI KIKUMORI Kasumi Tokusei Usu-ba

堺菊守 霞 特製 薄刃

- 180mm : 31-0006-0401
- 210mm : 31-0006-0402



⑤ SAKAI KIKUMORI Kasumi Tokusei Kamagata Usu-ba

堺菊守 霞 特製 鎌型薄刃

- 180mm : 31-0006-0501
- 210mm : 31-0006-0502



MASAMOTO SOHONTEN

Masamoto was founded in 1866. In 1874 it became the first business to manufacture and sell honyaki knives in the Kanto region. Since then, Masamoto has established its place as the highest quality knife brand in the eyes of Kanto chefs.

【 Hon-Kasumi Gyoku Haku-ko 】

Hon-Kasumi knives are Kasumi knives made with the highest quality steel. These knives are made from white steel, which is a high quality carbon steel, which has been forge welded with soft iron, and for this reason the blade boasts an exceptional cutting edge that lasts for long periods. This knife is also exceptionally high quality from the perspective of maintenance.



① MASAMOTO Hon-Kasumi Gyoku Haku-ko Yanagi-ba

正本 本齋 玉白鋼 柳刃

- 270mm : 31-0007-0101
- 300mm : 31-0007-0102



② MASAMOTO Hon-Kasumi Gyoku Haku-ko De-ba

正本 本齋 玉白鋼 出刃

- 150mm : 31-0007-0201
- 165mm : 31-0007-0202
- 180mm : 31-0007-0203
- 210mm : 31-0007-0204



③ MASAMOTO Hon-Kasumi Gyoku Haku-ko Usu-ba

正本 本齋 玉白鋼 薄刃

- 210mm : 31-0007-0301

Parts of a Japanese Knife

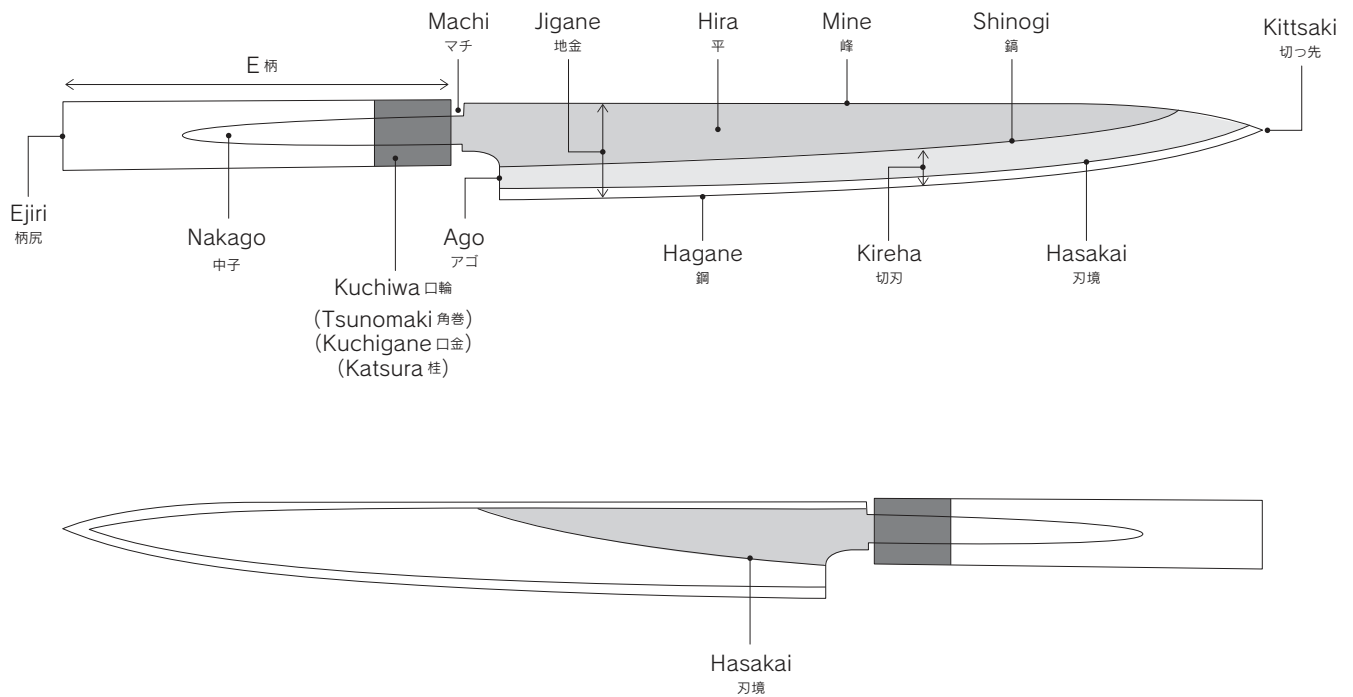

Name

- **Kittsaki**
切っ先 The edge can be used effortlessly for delicate work all the way to the tip.
- **Ago**
アゴ The corner of the blade closest to the handle.
- **Machi**
マチ The point at which the handle joins the blade in a traditional Japanese knife. The spine side of the machi is called the uemachi (or munemachi) and the blade side is called the shitamachi (or hamachi).
- **Mine**
峰 The back portion or the spine of the blade.
- **Hira**
平 The side of the blade.
- **Kireha**
切刃 The bevel on the front side of single beveled knives.
- **Shinogi**
鑓 The line that forms the border between the hira and the kireha.
- **Hasakai**
刃境 The line where the steel melds with the soft iron in layered knives.
- **Nakago**
中子 The shaft at the base of the blade that forms the core of the handle.
- **Kuchiwa**
口輪 The ring that secures the end of the handle that holds the nakago in Japanese knives. For knives made from stainless steel, it is often called a kuchigane, and for higher quality knives with buffalo horn handles, it is called a tsunomaki. For low cost, mass produced knives, it is often made from resin or ebonite, and in these cases it is often called a polycarbonate kuchiwa or a plastic kuchiwa.

Japanese Style

We never compromise on the sharpness. And we considering the costs for purchasing and also we do different finishing depending on each kind. We are designed considering the cost and durability reflecting many of requirements in the structures as well. This series will work as your supporting role but we are sure they will be your essentials.



1

1 SAKAI KIKUMORI Mukimono/Peeling Knife

堺菊守 極上むきもの包丁

● 31-0009-0101

Size (mm) : 180

This Japanese paring knife (mukimono knife) is mainly used for peeling strips of daikon, but is also ideal for peeling a range of fruit and vegetables.



2

2 SAKAI KIKUMORI Edo-Saki/Eel Ripping Knife

堺菊守 極上江戸裂

● 31-0009-0201

Size (mm) : 150

An Edosaki knife is the type of knife that is usually used for filleting eels in the Kanto region. In recent years, more and more regions around Japan have adopted the Kanto style shape of the Edosaki knife.

This shape is more common than those from other regions when slicing the eel down its back, which is the main function of an eel filleting knife, as well as removing the dorsal and ventral fins. Place the neck end of the spine in front of you, and use the tip to fillet it. Use the corner to remove the fins.



3

3 SAKAI KIKUMORI Sushikiri

堺菊守 特製すし切

● 240mm : 31-0009-0301

This is a special knife for cutting sushi rolls. The blade has a gentle curve that enables you to cut the ingredients in the middle of the rice, without crushing them. Insert the edge of the blade, and pull it towards you before pushing it to the side to separate.



4

4 SUGIMOTO Chinese-Style Cleaver

杉本 中華包丁

● No. 6 : 31-0009-0401

Size (mm) : 220×110

Weight : 430 g

※ Thin blade for cutting soft items such as meat or vegetables.

Sugimoto cleavers are used so widely by professional chefs in Japan that it is fair to say Sugimoto is synonymous with Chinese cleavers. Each knife is painstakingly crafted by skilled craftsmen. A layer of steel is squeezed between layers of soft iron, so you can use it until the blade width is reduced by about half.

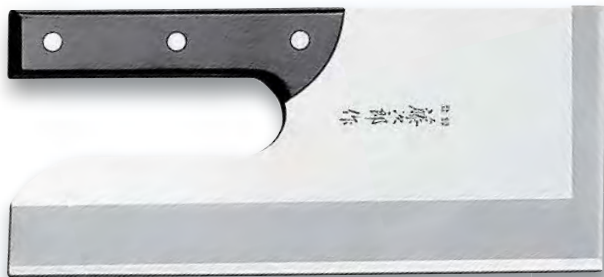

5

5 Tojiro MV Steel Soba Knife

藤次郎 MV鋼 そば切(片刃)

● F-744 : 31-0009-0501

Size (mm) : 300

Weight : 775 g

Material: Molybdenum vanadium steel

Blade is made from MV steel which have viscous and sharpness. It offers you high level rust resistance and professional cooks also satisfy the sharpness. Carefully designed handle would big help also for delicate work.



These high quality carving knives and forks are made in Japan. They are ideal for roasting and carving meat. These extremely popular products have comfortable wooden grips that have exude elegance



6

7

6 SAKAI KIKUMORI Stainless Carving Knife

堺菊守 カービングナイフ

● 31-0009-0601

Size (mm) : 335

刃渡り : 200

7 SAKAI KIKUMORI Stainless Carving Fork

堺菊守 カービングフォーク

● 31-0009-0701

Size (mm) : 285

【 Western Knives 】

When classifying western knives, it is more common to classify them by material or place of origin, rather than by production process. When classifying western knives by material, they can be broadly classified as special steel (stainless), and carbon steel (non-stainless).

Western Style Knife variation

Gyutou (Chef's Knife)



These knives are mainly used for meat, however they can be used for multiple purposes, including vegetables, fish, and bread.

Sujihiki (Slicing Knife)



These knives are used for slicing meat and tendons, and creating thin slices of meat. The shape is like a narrower version of a gyutou (chef's knife).

Santoku(Multi-Purpose Knife)



These multi-purpose knives are used in most Japanese homes. The blade is thin and can be used for preparing vegetables, meat and fish.

Yo- Deba



These knives are a thicker version of the gyutou, and are used for cutting meat that contains bones, half frozen items, and crustaceans such as crabs. When viewed from the side, these knives look very similar to a gyutou (chef's knife), however the blade is thick and durable, so that the spine of the blade can be used for breaking bones for soup etc. This knife has a very different feel to the gyutou (chef's knife); it is heavy, and not suited to cutting vegetables.

Petty Knife



The petty is a convenient size peeling and paring knife for vegetables, fruits, herbs and other delicate work.

Paring Knife



These small and versatile knives are suitable for a range of uses such as peeling fruit and vegetables, and cutting fruit decoratively for cakes.

Honesuki(Boning Knife)



These knives are designed for removing meat from bones. They are small and easy use, so they can be used for a variety of purposes. They are a knife that is unique to Japan, and they are also known as a 'sabaki knife'.

堺菊守

SAKAI KIKUMORI

Sakai knives boast superior edges, which are hand crafted by artisans, whose knowledge has been passed down over the company's 600-year long history. Sakai is a famous locale for knife production, both within Japan and around the world. In Japan, Sakai accounts for more than 90% of the professional high-quality knife market, and in 1982, it was designated by the government as a traditional craft. The Sakai Kikumori brand was born through the continuation of these traditional techniques along with the determination to introduce Sakai knives to many more people around the world through the incorporation of new technologies. Sakai KIKUMORI continues to conduct research and product development with the aim of providing superior knives, both within Japan and around the world, while contributing to the continuation of its extensive history.

【 Japanese Carbon Steel 】

Sakai knives are western style knives that are made from Japanese steel (SK). These knives are carefully crafted by artisans. The relatively affordable price has led these products to be very popular.



① SAKAI KIKUMORI
Japanese Carbon Steel
Gyutou (Chef's knife)

堺菊守 日本鋼 牛刀

- 180mm : 31-0011-0101
- 210mm : 31-0011-0102
- 240mm : 31-0011-0103
- 270mm : 31-0011-0104
- 300mm : 31-0011-0105

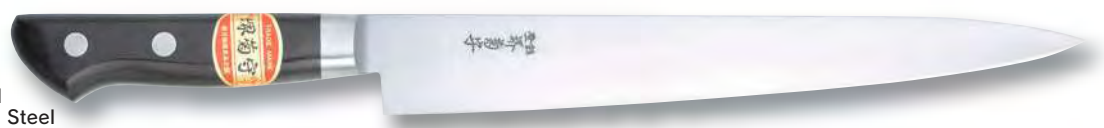

② SAKAI KIKUMORI
Japanese Carbon Steel
Sujihiki (Slicing knife)

堺菊守 日本鋼 筋引

- 240mm : 31-0011-0201
- 270mm : 31-0011-0202



③ SAKAI KIKUMORI
Japanese Carbon Steel
Petty Knife

堺菊守 日本鋼 ペティ

- 120mm : 31-0011-0301
- 150mm : 31-0011-0302



④ SAKAI KIKUMORI
Japanese Carbon Steel
Honesuki

堺菊守 日本鋼 骨スキ

- 150mm : 31-0011-0401



⑤ SAKAI KIKUMORI
Japanese Carbon Steel
Yo-Deba

堺菊守 日本鋼 洋出刃

- 210mm : 31-0011-0501

堺菊守

【 Standard 】

These are the standard model of Kikumori western knives. They use special stainless steel that includes molybdenum and vanadium, so they are rust resistant, easy to sharpen, and easy to use.

① SAKAI KIKUMORI Standard Gyutou (Chef's knife)

堺菊守 スタンダード 牛刀

- 210mm : 31-0012-0101
- 240mm : 31-0012-0102
- 270mm : 31-0012-0103
- 300mm : 31-0012-0104



② SAKAI KIKUMORI Standard Sujihiki (Slicing knife)

堺菊守 スタンダード 筋引

- 240mm : 31-0012-0201
- 270mm : 31-0012-0202



③ SAKAI KIKUMORI Standard Petty Knife

堺菊守 スタンダード ペティ

- 120mm : 31-0012-0301
- 150mm : 31-0012-0302



④ SAKAI KIKUMORI Standard Santoku (Multi-Purpose knife)

堺菊守 スタンダード 三徳

- 180mm : 31-0012-0401



⑤ SAKAI KIKUMORI Standard Honesuki

堺菊守 スタンダード 骨スキ

- 150mm : 31-0012-0501



⑥ SAKAI KIKUMORI Standard Yo-Deba

堺菊守 スタンダード 洋出刃

- 210mm : 31-0012-0601



堺菊守

Damascus Steel

Damascus steel was created in ancient India, and is also known as wootz steel. The unique feature of this type of steel is the distinctive patterning that appears on the surface when it is polished. It is said that this type of steel will not rust.

Swords with the beautiful and distinctive patterning of Damascus steel were prized as royal family heirlooms during the crusades. It is also said that knights were proud if they were able to own Damascus steel blades.

At present, any steel used to produce blades that has been artificially forged with layers of different types of steel to produce the distinctive Damascus type of patterning is known as Damascus steel.

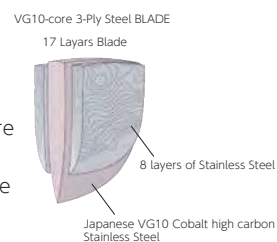

【 Damascus Hammered V10 】

These elegant western style knives are made from Sakai Kikumori Damascus steel. The blade is composed of a core of ultra-hard VG-10 steel alloy with corrosion resistant, durable stainless steel on either side. The blades are ground by experienced craftsmen, so they have unparalleled sharpness and durability, so you can use them continue to use them into the future. The design created by the 17 layers of Damascus stainless steel in the core is not only beautiful, but the hammered finish is also functional in that it allows ingredients to slide off the knife easily. The handle is crafted from mahogany, which matches the elegant design of the blade.



① SAKAI KIKUMORI Damascus Hammered V10 Gyutou (Chef's knife)

堺菊守 ダマスカス V10 極目 牛刀

●210mm : 31-0013-0101



② SAKAI KIKUMORI Damascus Hammered V10 Sujihiki (Slicing knife)

堺菊守 ダマスカス V10 極目 筋引

●240mm : 31-0013-0201



③ SAKAI KIKUMORI Damascus Hammered V10 Petty Knife

堺菊守 ダマスカス V10 極目 ペティ

●140mm : 31-0013-0301



④ SAKAI KIKUMORI Damascus Hammered V10 Santoku (Multi-Purpose Knife)

堺菊守 ダマスカス V10 極目 三徳

●180mm : 31-0013-0401

匠

SAKAI KIKUMORI

It is the brand leader that a tradition of the Sakai origin is still inherited.



左近白梅

SAKON Nickel Damask

73Layers Blade

Fine Crafted Pure Nickel Damascus knives with few equals.

Artistic blades come fitted with a top-notch Japanese pro-chef style grip.

SAKON Nickel Damask Features

The blade is a triple lamination that reproduces a traditional Damascus surface. The two Damascus outer layers are each made of 36 alternating forged layers of Pure-Nickel and SUS410 stainless steel polished to reveal a pattern that is as unique as a fingerprint.

A polished octagonal Ebony wooden handle enhances the beauty of each blade. These handle shapes are found on the top professional Japanese sushi knives. Not only a pleasure to look at, the traditional distinctive grip will aid cutting tasks that require precision.



Japanese Professional Octagonal grip

The central core material SKD11 (alloy tool steel) used for the blade edge is a performance steel that is incredibly rich in Carbon equal to the famed Yasuki Aogami, and is tempered to the Rockwell 62-64 for exceptional sharpness and edge holding properties.

Originally SKD11 steel was created for cutting metal. Its suitability for knife edges' comes from its resistance to abrasion and its ability to hold a cutting edge. Also its high content of Chromium greatly contributes to the blade's anti-corrosion. Damascus outer Pure-Nickel layers will never rust.

This 73 layered material produces a rust resistant blade that will maintain its beautiful pattern perfection over the years.

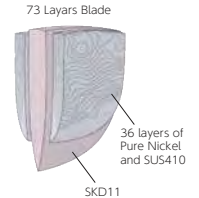

1 SAKON Nickel Damask WA-Gyutou (Chef's Knife)

左近白梅 ニッケル ダマスカス 牛刀

● 210mm : 31-0015-0101

· An excellent length for the more confident cook or the professional chef.

● 240mm : 31-0015-0102

· Strictly for professionals or those with a very large hand span. This knife, with its impressive length, is the heaviest in the collection.



2 SAKON Nickel Damask WA-Santoku (Multi-Purpose Knife)

左近白梅 ニッケル ダマスカス 三徳

● 165mm : 31-0015-0201

· A traditional home kitchen style knife for preparing a wide variety of food. Slicing, mincing, and chopping are effortless with this standard Santoku.



3 SAKON Nickel Damask WA-Petty Knife

左近白梅 ニッケル ダマスカス 小柳包丁

● 165mm : 31-0015-0301

· The Japanese popular slicer, a petite knife, suitable for slicing and working with small items.

艶色

SAKON
NICKEL DAMASK

The gem which had fascinatedness and utility by the special structure.





The Origins of KYUBEI

Kyubei began as a blacksmith's shop founded by Kyubei Kishi below Nagoya Castle, in the Owari domain, in the late 1700s, which was during the latter part of the Edo period. The shop continued to operate in Hisaya-cho for 6 generations through the Meiji restoration, however trading ceased due to the chaos created by the Pacific War. In August 1945, Yasuji Kishi (7th generation) founded the Kishiyasu store (currently Kishiyasu Corporation Ltd.), and resumed business as an ironmonger. However, during the rapid expansion of the Showa period, businesses began to transition into becoming kitchenware wholesalers geared towards the food service industry, and this business, which had been an iron foundry since its inception released the Kyubei brand of knives. To this day, the main office of the Kishiyasu Sangyou Co., Ltd. is located in the old foundry district (currently Marunouchi 3-chome, Naka-ku, Nagoya), and produces cast iron and other metal kitchen products for the national and global markets.

【 Molybdenum Washiki 】

These superior quality western knives are made from extremely corrosion and abrasion resistant molybdenum vanadium steel, which will not rust. The carbon is refined with a fine structure so the blade is durable and has an exceptional cutting edge. Although this is a western knife, the grip is comfortable, and it adopts a well-designed Japanese wooden handle, making this a truly global knife.



① KYUBEI Molybdenum Stainless Steel WA-Gyutou (Chef's knife)

久兵衛 モリブデン和式 牛刀

- 210mm : 31-0017-0101
- 240mm : 31-0017-0102
- 270mm : 31-0017-0103

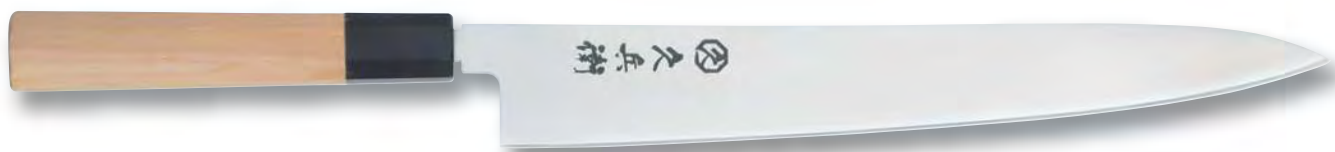

② KYUBEI Molybdenum Stainless Steel WA-Sujihiki (Slicing knife)

久兵衛 モリブデン和式 筋引

- 270mm : 31-0017-0201



③ KYUBEI Molybdenum Stainless Steel WA-Petty Knife

久兵衛 モリブデン和式 ペティ

- 150mm : 31-0017-0301

精

KYUBEI WESTERN STYLE

The smart Western-style kitchen knife which the blacksmith creates.





ECHIZEN JAPAN
Knife Consortium since 1337

Echizen uchihamono forged blades can trace their origins back nearly 700 years to Japan's Nanboku-cho period (1336 to 1392) when the renowned Kyoto swordsmith Kuniyasu Chiyojuru began producing sickles and other agricultural blades in addition to swords for local farmers in Echizen in what is now Fukui Prefecture. It is said that the whetstones used by Chiyojuru when creating a blade were carved into a komainu - the guardian dog found at the entrance to shrines - which were then dropped into a well. This was intended to incorporate Chiyojuru's wish as a craftsman that his blades would not be used as weapons for taking human life and would only act as a symbol of the warrior. This philosophy of creating blades not for the taking of life but for use as an "ultimate tool" has been continued to this day by the craftsmen who still produce Echizen uchihamono forged blades. The highest quality forged blades that are handcrafted by Echizen craftsmen produce the sharpest of edges tempered by the process of hizukuri forging that is rooted in this region's history.

Kitchen Knives

The cut configuration connecting the blade and handle and the roundness of the handle on ECHIZEN-JAPAN knives allow a variety of grips to be used when handling each knife.

Ensuring the knife fits perfectly and securely into the user's hand is the product of the perfectly designed balance of weight and configuration that goes into each knife.



Blade materials for achieving the sharpest edge.

Spoon cut configuration allows a variety of different grips.

Blast finished sturdy handle fits perfectly in your hand.

The ECHIZEN-JAPAN kitchen knife series provide a sense of oneness in the blade through a fusion of the highest quality cutting edge and ease-of-use made by Echizen craftsmen. These extraordinary blades provide the user with a sense of pleasure in holding and using each knife.



Knife Packaging
 Traditional Japanese Style

Clad metal for the highest quality

The material used for the blade is clad metal manufactured using world-leading techniques by local companies in Echizen. Clad metal is produced by forging different layers of metal together, taking advantage of the strength of each piece as an integrated unit while ensuring any weaknesses are balanced out by each layer.

Cutting steel used in the knives' manufacture is produced by a company with extensive experience in this field, and the steel for the blade is composed of a perfect blend that produces a long-lasting and extremely sharp cutting edge. This produces a knife blade that is hard to bend or break and is rust resistant.

VG10, Finest stainless cutting steel

VG10 stainless cutting steel is made from strictly selected pure iron that is worked using an optimal blend to produce an extremely sharp high-quality cutting steel manufactured using the finest steel processing technology. Its high corrosion resistance means that it is rust resistant and its superior abrasion resistance ensures that it retains its sharp edge.

VG10	Carbon	Chromium	Molybdenum	Vanadium	Cobalt
	1.0 %	15.0 %	1.0 %	0.2 %	1.5 %



ECHIZEN JAPAN
Knife Consortium since 1337

1310

Core-Less Multi-Layer Steel BLADE Stainless Steel HANDLE

As its name suggests, the blade literally has no core blade but is instead made up of an accumulation of 70 layers using two types of steel, which create unique patterns on the blade's surface.

Due to its layered structure, the blade is stronger and more rigid than those using only a single steel.

This completely original design achieved by Japanese artisan is the only blade of its kind in the world.

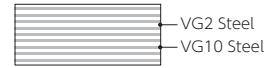

Each knife has different patterns due to handcraft.



① 1310 Gyutou(Chef's Knife)

1310 牛刀 210mm

● 210mm : 31-0020-0101

Size (mm) : Blade 210 Handle 123
Weight : 150 g



② 1310 Sujihiki(Slicer Knife)

1310 筋引 240mm

● 240mm : 31-0020-0201

Size (mm) : Blade 240 Handle 123
Weight : 146 g



③ 1310 Petty Knife

1310 ペティ 150mm

● 150mm : 31-0020-0301

Size (mm) : Blade 150 Handle 105
Weight : 70 g



④ 1310 Santoku(Multi-Purpose Knife)

1310 三徳 180mm

● 180mm : 31-0020-0401

Size (mm) : Blade 180 Handle 123
Weight : 160 g

Tojiro-Pro®

Japanese cooking knife could be called as "The fruit of Japanese traditional technology" because it has been evolving with progress of Japanese cooking culture. And it is passed down from craftsman to craftsman through very long period. There are some areas to make cutting tools in Japan even now and Tsubame-Sanjo area in Niigata prefecture is also one of them, where Tojiro factory is located.

We have been pursuing "The Sharpness" of cutting tools from our establishment, which is basic function of knife. It is not an exaggeration to say the sharpness of knife would influence the completion of cooking because Japanese cooking esteems beauty of cutting face, brightness and brilliance of knife.

Then, we have been brushing up traditional technology and developed our own technology as DP method with examination of blade material. It means we have been challenging technology innovation from our establishment and delivery wide range products for not only professional use but also common house use in whole world with conflation of most advanced technology and traditional technology.

We put tornado patterns, an identity of "Tojiro", on the handle designed considering comfortable grip as a top priority. It provides you not only the beautiful looking but less slippery even if you use it with wet or greasy hands. The handle entirely united with blade without joint prevent bacterium from propagation and spreading. It also can be sterilized in boiling water. Sticking to the keenness, the edge satisfies even professionals and can be re-sharpened easily.

DP 3LAYERED SERIES BY VG10

This series knives are made from high class blade steel as Cobalt alloy steel through perfect quality control with our own DP clad technology and sharpened by handwork of our skilled workman. This is really our original superior knife series for professional use by sharpness, durability, rust resistance and etc.

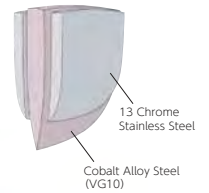

1 Tojiro-Pro Gyutou (Chef's Knife)
Tojiro-Pro 牛刀

- 210mm : 31-0021-0101
- 240mm : 31-0021-0102
- 270mm : 31-0021-0103



2 Tojiro-Pro Sujihiki (Slicing Knife)
Tojiro-Pro 筋引

- 240mm : 31-0021-0201
- 270mm : 31-0021-0202



3 Tojiro-Pro Petty Knife
Tojiro-Pro ペティ

- 120mm : 31-0021-0301
- 150mm : 31-0021-0302



4 Tojiro-Pro Santoku (Multi-Purpose Knife)
Tojiro-Pro 三徳

- 170mm : 31-0021-0401



5 Tojiro-Pro Paring Knife
Tojiro-Pro パーリングナイフ

- 90mm : 31-0021-0501

創

TOJIRO·PRO

A product made in all stainless steel which original state-of-the-art creates.



SAKON+

The evolution of the blade given "form"... [SAKON•PLUS]

Iron was introduced to Japan and iron bladed implements first became available more than 2,300 years ago, in the Yayoi period. Knives with a modern shape first appeared in the Muromachi period, and during the 600 or so years since then, artisans and engineers have developed their ideas to produce knives such as today's "warikomi", "stainless steel", and "ceramic knives". Then, in 2010, an entirely new type of next generation knife, which renews its own blade, was developed. This knife was the "Sakon Plus".

vee-tech®
Vivid-edge-effect-tech processed blade

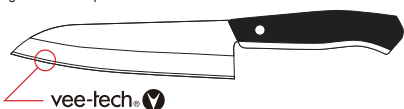

"Vee-Tech" is the brand new patented processing originally developed for aircraft & spaceships. It has successfully brought an incredible sharpness to the blade, a sharpness that will last longer than ever before. This process gradually transforms the cutting edge from traditional steel into a micro carbide melted alloy.

Comparison of the deterioration of the point of a sword

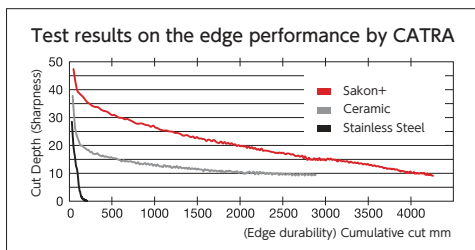
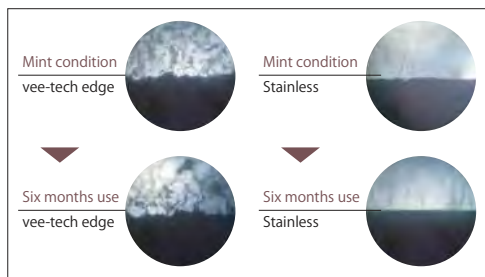

+Edge

"Vee-tech" gives a wear resistance quality to the melted hard carbide produced blade. The cutting edge that gradually regenerates with use is one of SAKON's outstanding features. New micro-serrated carbide particles appear on top of the edge automatically. This is the secret of how the SAKON+ edge maintains its unbelievable sharpness - as do the ceramic knives - without having to be sharpened.

The Incredible Edge retention & sharpness has been verified not only by the remarkable CATRA testing results but also by professional chefs at work.

SAKON+ can be sharpened as desired by using a conventional whetstone. please refer to the inner instructions.



① SAKON Plus Petty Knife
SAKON+(プラス) ペティ 135mm
● 31-0023-0101



② SAKON Plus Santoku (Multi-Purpose Knife)
SAKON+(プラス) 三徳 180mm
● 31-0023-0201



+Grip

The stylish "Sakon Plus" handle is made from methacrylic artificial marble that has been carved into an easy to grip form. This elegant homogenous solid material lends an "atmosphere" befitting a beautiful kitchen space. Artificial marble is a shock resistant, weather resistant, heat resistant, and chemical resistant homogenous and non-porous material. This means you don't need to worry about it becoming dirty, and with some simple maintenance you can keep your knife beautiful and clean.



MASAHIRO

Masahiro is based in Seki city in Gifu prefecture, which boasts a history of sword smithing that spans 780 years, and has been manufacturing and selling knives for over 70 years, all the while receiving praise for its products. Seki city is known as the sword capital of Japan, and has produced many famous artisans since the Kamakura period up to the present day. In addition to the high level of skill involved in the manufacture of Seki swords, Seki swords were also prized by many military commanders for their superior utility and because 'they do not break or bend, and they cut well.' At present, Seki has a large share of the national safety shaver, nail clipper, scissors, and knife markets. Masahiro is one of the top knife manufacturers and produces exceptional products, conducting nearly all processes in-house, from tempering to finishing.

【 Japanese Steel 】

These knives use original carbon steel (pure Japanese steel), which holds an exceptionally durable edge. Each of these genuine western knives has unquestionable quality and grows more comfortable the more you use it.



① MASAHIRO Japanese Carbon Steel Gyutou (Chef's knife)

正広作 日本鋼 牛刀

- 210mm : 31-0024-0101
- 240mm : 31-0024-0102
- 270mm : 31-0024-0103



② MASAHIRO Japanese Carbon Steel Sujihiki (Slicing knife)

正広作 日本鋼 筋引

- 240mm : 31-0024-0201
- 270mm : 31-0024-0202



③ MASAHIRO Japanese Carbon Steel Petty Knife

正広作 日本鋼 ペティ

- 120mm : 31-0024-0301
- 150mm : 31-0024-0302



Misono is a specialist manufacturer that has continued to forge professional knives in the sword making capital of Seki, which is famous for its Seki Magoroku swords with a tradition of 800 years.

Just as tamahagane steel is beaten, forged, and tempered in a blazing flame to burn the spirit into the sword, Misono knives are forged by the masterful skill of experienced craftsmen.

The master craftsmen at Misono have developed a production method that combines traditional skills with cutting edge technology that makes liberal use of machinery to forge, shape, temper, grind, and polish metals such as steel and stainless steel. Misono is an integrated manufacturer that prides itself on producing technologically advanced blades for cooking.

Misono's advanced technology takes edge sharpness to the next level.

■ Sub-zero processing

Sub-zero processing is a special process that involves cooling the blade to -70°C after tempering. It gives the blade greater hardness and toughness to take the blade to the next level.

■ Traditional sharpening

The blades are sharpened by professional artisans using natural stone in the traditional manner. Re-sharpening is simple.



UX10 SERIES

UX10 EU Sweden Stainless Steel Series

These knives, made from a special type of pure Swedish and European stainless steel are a combination of Misono's ancient traditions and new technology, and are the pinnacle of stainless steel knives. They boast the sharp cutting edge and ease of sharpening of traditional steel blades.

These knives are made from stainless steel, which makes them rust resistant, but they also have a similar hardness to carbon steel, (HRC 59~60), which makes them easy to sharpen, long lasting, and sharp for stainless steel blades.

The main feature of UX10 knives is the shape of the join between the handle and the blade. We introduced a new diagonal join in the pursuit of sharpness and ease of use. We used nickel silver for the rivets and join for a sharp and high-tech design that strongly expresses quality and style.



① Misono UX10 Gyutou (Chef's Knife)

ミソノ UX10 牛刀

- 210mm : 31-0025-0101
- 240mm : 31-0025-0102
- 270mm : 31-0025-0103



② Misono UX10 Sujihiki (Slicing Knife)

ミソノ UX10 筋引

- 240mm : 31-0025-0201
- 270mm : 31-0025-0202



③ Misono UX10 Petty Knife

ミソノ UX10 ペティ

- 120mm : 31-0025-0301
- 150mm : 31-0025-0302



440 SERIES

440 Misono 16 Cr. Molybdenum Stainless Steel Series

These knives use 16 Cr. stainless steel, which is even more rust resistant and durable than the standard 13 Cr. Stainless steel. These masterpieces are the epitome of high quality professional blades. They have a professional form, hold a professional edge, won't rust, and are easy to sharpen.

1 Misono 440 Gyutou
(Chef's Knife)

ミソノ 440 牛刀

- 210mm : 31-0026-0101
- 240mm : 31-0026-0102
- 270mm : 31-0026-0103



2 Misono 440 Sujihiki
(Slicing Knife)

ミソノ 440 筋引

- 240mm : 31-0026-0201
- 270mm : 31-0026-0202



3 Misono 440 Petty Knife

ミソノ 440 ペティ

- 120mm : 31-0026-0301
- 150mm : 31-0026-0302



MOLYBDENUM STAINLESS STEEL SERIES

Stainless Molybdenum Steel Series

These blades contain molybdenum, which improves the cutting edge. They use high-carbon, high-quality 13 Cr. Stainless molybdenum steel. Crafted with a high level of skill and technology, these stainless steel blades will not rust and will keep a sharp edge.

4 Misono Molybdenum
Stainless Steel
Gyutou(Chef's Knife)

ミソノ モリブデン鋼 牛刀

- 210mm : 31-0026-0401
- 240mm : 31-0026-0402
- 270mm : 31-0026-0403



5 Misono Molybdenum
Stainless Steel
Sujihiki(Slicing Knife)

ミソノ モリブデン鋼 筋引

- 240mm : 31-0026-0501
- 270mm : 31-0026-0502



6 Misono Molybdenum
Stainless Steel
Petty Knife

ミソノ モリブデン鋼 ペティ

- 120mm : 31-0026-0601
- 150mm : 31-0026-0602



SHARPENING STONE SERIES

There is no knife do not have to be re-sharpened in the world. Every single knife has to be re-sharpen after use because the edge worn out and you cannot keep the sharpness without the maintenance. Using sharpeners or sharpening bar is very easy, however, it cannot get the original sharpness back because it is just temporary repair . You may think it is hard but actually much easier than you think. Why don't you try with a knife you don't need.

Uses of each sharpening stone

[#280~#400]

Rough Grinding Sharpening stone / Repair for nicks and shape

[#800~#1200]

Middle Grinding Sharpening stone / Abrasion of big scratch and smoothing blade tip

[#3000~#10000]

Finishing Sharpening stone / Abrasion of scratch and sharpening blade

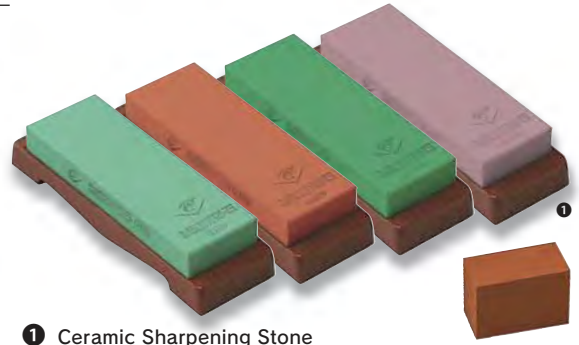

1 Ceramic Sharpening Stone

超セラミックス砥石 台付(修正用砥石付)

Correction whetstone

- #400 : Arato/Rough (Green) 31-0027-0101
- #800 : Nakato/Medium (Red) 31-0027-0102
- #1000 : Naka-Shiage/Medium Fine (Light Green) 31-0027-0103
- #3000 : Shiage/Fine (Pink) 31-0027-0104

Size (mm) : 210×70×H25mm

・ Keep a sharp edge, even on hard steel knives, using these premium quality Sharpening stones.



2 Sharpening Stone GC #220 3cho-gake Arato/Rough

砥石 荒砥細目 GC #220

● 31-0027-0201

Size (mm) : 205×75×H50



3 Sharpening Stone Akamonzen DX #1000 Nakato/Medium

砥石 中砥 赤門前DX #1000

● 31-0027-0301

Size (mm) : 210×65×H32



4 Sharpening Stone King DX Naka-Shiage/Medium Fine #1000

キングデラックス 中仕上げ砥石

Size (mm)

- 3cho-gake : 209×70×H60 31-0027-0401
- 1cho-gake : 207×66×H34 31-0027-0402



5 Sharpening Stone #4000 Shiage/Fine

砥石 仕上げ #4000台無

● 31-0027-0501

Size (mm) : 200×70×H24



6 Sharpening Stone #6000 Shiage/Fine with Stone Base

キング 仕上げ台付砥石

● S-1(#6000) : 31-0027-0601

Size (mm) : 210×73×H22



Synthetic and ceramic water stones become concave with frequent use. A flat water stone is essential for sharpening. Use a stone fixer to flatten the stone before sharpening

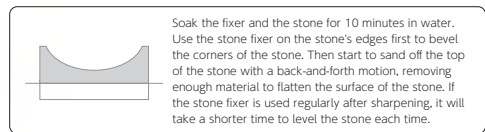

Soak the fixer and the stone for 10 minutes in water. Use the stone fixer on the stone's edges first to bevel the corners of the stone. Then start to sand off the top of the stone with a back-and-forth motion, removing enough material to flatten the surface of the stone. If the stone fixer is used regularly after sharpening, it will take a shorter time to level the stone each time.

7 Stone Fixer Mini

溝入り面直し砥石 ミニ QA-0160

● 31-0027-0701

Size (mm) : 170×55×H30

・ Quickly correct grooves in your whetstone.



8 Sharpening Steel Bar

スチール棒

● 12 inch : 31-0027-0801

Size (mm) : 300



9 Ceramic Rolling Sharpener

セラミックローリングシャープナーRS-20-FP

● 31-0027-0901

Size (mm) : 193×55×H69

・ Just run your knife forward and backward approximately 10 times to get the benefit of using both a rough stone and a finishing stone.

CAUTION FOR USE

Because sharpener is a tool to make the edge rough, this let the edge eat into foods more. However, this is just a temporary repair and cannot be substitution of sharpening by whetstones. If you keep sharpening by sharpener only, it may cause nicks or cracks on the edge. We recommend sharpening by sharpening stone at least once or twice in a month even if you use sharpeners. #Notched or Single edge cannot be sharpened by this sharpener.

How to Re-sharpen Knife | 包丁の研ぎ方

If handling of knife is not correct, all matters like bite of knife and brilliance and etc. would be lost. This is easy introduction of necessary care and re- sharpening method to keep high quality knife forever.

高丁の切れ味も素材の輝きも、正しく扱わなければ、すべて失われてしまいます。いつまでも高い品質を保つために必要な研ぎ方をわかりやすくご紹介いたします。

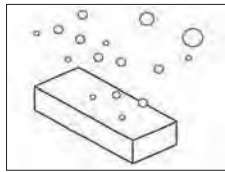

Grind stone should absorb enough water until air bubble will not come out.

砥石を使用する前に水につけ、気泡が出なくなるまで水を含ませてください。

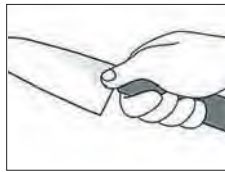

Please hold knife well with thumb to keep knife fast condition.

しっかりと高丁を握り、親指で上から押さえつけるようにして高丁がぐらつかないようにしてください。

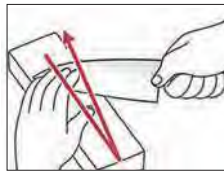

Please re-sharpen knife from top blade with blade looks towards you. Please keep around 60° angle between grind stone and top blade.

刃を手前に向け、刃先の方から研いでください。砥石と刃先の角度を60度くらいに保つようにしてください。

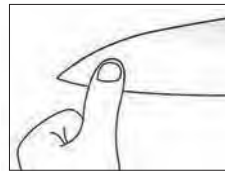

After re-sharpen several times, please check whether blade has back or not by finger touch. If there is a back on blade, you can finish the work.

数回研いだら指で触りながら引っかかりがあれば「刃返し」がある証拠ですので、研ぎを終了してください。

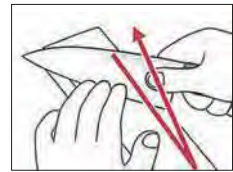

After top blade, please re-sharpen middle of blade. Please check the back by finger touch after several times working same as before process.

刃先を研ぎ終わったら刃の真ん中を研いでください。数回研いだら、指で触って「刃返し」を確認してください。



Finally, please re-sharpen barb area. On this area, no need to re-sharpen to acute angle. Please re-sharpen to obtuse angle.

最後にアゴの部分研ぎます。アゴの部分はあまり鋭利にはせず、鈍角に研いでください。

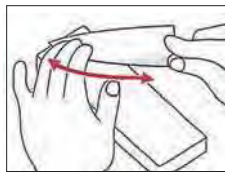

Please re-sharpen back side of knife with blade looks towards opposite side. But please not re-sharpen this side so well. You can finish the work just take away the back.

刃先を向こう側にして高丁の裏面を研ぎ、裏側は刃返しをとる程度にしてください。

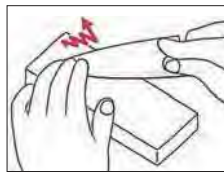

Please re-sharpen back side to take away the back until blade would be felt smoothly by finger touch.

刃全体が滑らかになるように指で触って「刃返し」がなくなるまで研いでください。

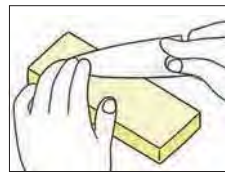

In case of having finish grind stone, please use it finally for adjustment of top blade.

仕上げ砥石がある場合には、最後に仕上げ砥石を使い、刃先を整えてください。

Double edge | 両刃の場合

Re-sharpen face by same angle which would be kept by single disposable chopstick. Back side should be re-sharpened by more acute angle.

割り箸一本程度の角度を一定に保つように、刃を動かさずに表面を研ぎます。裏面はさらに浮かせ気味にして研ぎます。

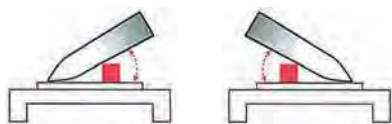

Single edge | 片刃の場合

Blade and grind stone should touch well by adjustment of blade angle. If angle is not fixed well, blade shape would be not correct.

刃の角度に合わせて、切刃と砥石がぴったりくっつくように研ぐのが基本です。角度を一定にしないと「しゃくり研ぎ」になってしまいます。

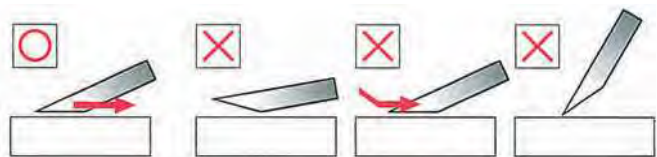

Features of “Anti-Bacterial Peel Type Rubber Cutting Board”

The “Wood Core” cutting board is the first light-weight rubber cutting board with a wood core available in Japan.

Features

- The major features are “grime resistance” and “feel”. In addition, it has antibacterial properties so you can rest assured that it will be clean and hygienic when you use it.
- The surface is wood coloured, which markedly reduces eye strain.
- ※ The rubber is a special type, which cannot be used in UV sterilizers.
- The elasticity of the rubber helps to maintain the sharpness of your knife.
- This board is light, but will not bend. It is also completely odorless.



1 Anti-Bacterial



Cross section

1 Anti-Bacterial Peel Type Rubber Cutting Board

抗菌ラバー・おとくまな板 ORB04

4-layer type

L×W (mm)	Thickness(mm)	(kg)	
● 500×250	: 30	3.1	31-0029-0101
● 750×350	: 30	6.1	31-0029-0102
● 1,000×400	: 35	11.1	31-0029-0103
● 1,200×450	: 35	14.8	31-0029-0104

· This board has an economical removable layered construction (each layer is 5.5 mm thick), so if the surface becomes scratched, there is no need to sand it, just remove the top layer to reveal a fresh cutting surface. It is easy to peel off the layers using the clear separation lines.

· Boards with a length of 600mm or less have removable layers on both sides.



2

2 Hi-Soft Cutting Board

ハイソフト まな板

	L×W (mm)	Thickness(mm)	(kg)	
● H5	: 750×330	20	5.0	31-0029-0201
● H9	: 900×450	20	8.1	31-0029-0202
● H10B	: 1,000×400	20	8.0	31-0029-0203
● H11A	: 1,200×450	20	10.8	31-0029-0204

Top grade synthetic surface. A very soft, popular cutting surface for Sushi chefs.

Closely resembles wood in color, texture and softness.

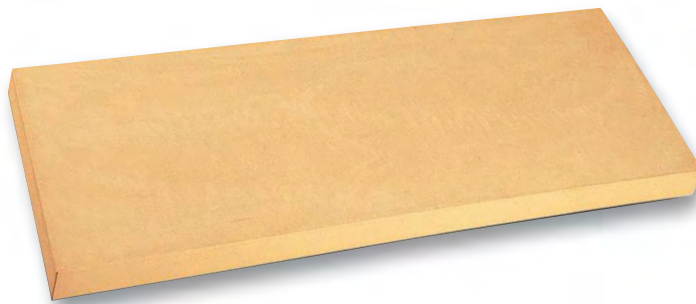

3

3 Rubber Cutting Board

クッキンカット (合成ゴム)

	L×W (mm)	Thickness(mm)	(kg)	
● No. 105	: 750×330	20	6.3	31-0029-0301
● No. 111	: 1,000×400	20	10.1	31-0029-0302
● No. 114	: 1,200×450	30	20.4	31-0029-0303

Our hardest rubber cutting board is forgiving on sharp knife edges. Resembles wood in color, texture and so softness.



4 Anti-Bacterial

4 Cutting Board

N抗菌耐熱まな板 (ポリエチレン)

	L×W (mm)	Thickness(mm)	(kg)	
● LL	: 420×230	13	1.2	31-0029-0401
● L	: 370×220	13	1.0	31-0029-0402

- Comes with a cutting board stand (polypropylene)
- The anti-bacterial ingredient makes this product hygienic.
- Can be placed in dishwashers and dryers.

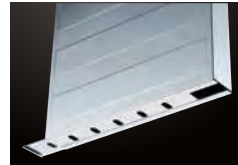

The base slides for easy washing and draining.

1 Rubber Covered Knife Stocker

ゴム付包丁差(釘打)

W×D×H (mm)

- L - 2-tiered : 323×100×370 31-0030-0101

2 Compact Cutting Board Stand

KYS18-8 コンパクトまな板立て縦・横兼用型

W×D×H (mm) (mm)

- Holds 3 : 220×203×135 30 31-0030-0201
- Holds 4 : 220×203×135 30 31-0030-0202

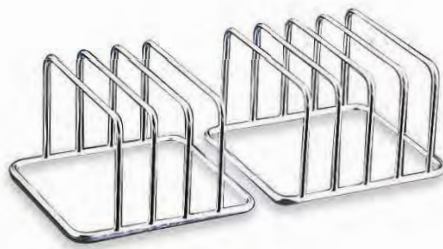

3 Clean Edge Scorch Remover for Cutting Board

クリーンエッジ

- 31-0030-0301

Size (mm) : 203

· Cleans tough to remove grime from cutting boards and counter tops.

Vikan Hygiene System

- The polyester filaments are held in firmly with stainless steel to prevent them from coming out.
- Polyester is hygienic because it does not absorb water, so it dries quickly, which prevents bacteria from multiplying.
- Heat resistant up to 120°C, as well as being acid, alkali, and oil resistant, so it can be used anywhere.

- The brush body is made from solid polypropylene, so it is sturdy and there is no risk of contamination due to cracking.
- The Vikan hygiene system was designed based on ergonomics.
- The optimal handle shape for ease of grip and size for efficient work were calculated to ensure positive work efficiency and the ability to work for long periods without growing tired.

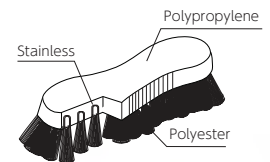

4 Colored Hand Brush(Soft)

ヴァイカン ハンドブラシ3587(ソフト)

W×D×H (mm)

- Blue : 170×45×40 31-0030-0401

· Compact sized soft hand brush that is even easy for women to use.
· Can be used for multiple purposes, such as cleaning countertops and containers.



5 Colored Cutting Board Brush(Soft)

ヴァイカン まな板洗浄ブラシ6441(ソフト)

W×D×H (mm)

- Blue : 118×47×H47 31-0030-0501

· Compact sized cutting board cleaning brush.
· Even removes grime caught in scratches in the board's surface.

THE JAPANESE
KITCHENWARE



In Japanese cooking, rather than adding concentrated seasonings to actively impart flavour, emphasis is placed on drawing out the natural qualities of the ingredients. Stewing and boiling techniques are often used to extract stock for this purpose. These aluminum pots have traditionally been most commonly used in Japanese restaurants. They are easy to cook with due to their high thermal conductivity and lightness.



1 Aluminium Cooking Pot

アルミ 打出料理鍋

	ID×H (mm)	(ℓ)	
● 30cm :	300×135	8.0	31-0032-0101
● 33cm :	330×150	11.0	31-0032-0102
● 36cm :	360×165	13.5	31-0032-0103
● 39cm :	390×175	16.0	31-0032-0104
● 42cm :	420×185	22.0	31-0032-0105
● 45cm :	450×200	26.0	31-0032-0106

- ・ This is known as a large, all-purpose pan.
- ・ It can be used with a round steaming basket.



2 Aluminium Lid for Cooking Pot

アルミ 料理鍋蓋

	OD (mm)	
● 30cm :	295	31-0032-0201
● 33cm :	323	31-0032-0202
● 36cm :	354	31-0032-0203
● 39cm :	382	31-0032-0204
● 42cm :	412	31-0032-0205
● 45cm :	440	31-0032-0206



3 Wooden Lid for Cooking Pot

鍋フタ(サワラ材白付)

● 30cm :	31-0032-0301
● 33cm :	31-0032-0302
● 36cm :	31-0032-0303
● 39cm :	31-0032-0304
● 42cm :	31-0032-0305
● 45cm :	31-0032-0306

Thickness : 10 mm



4 YUKIHIRA Aluminium Cooking Pot

アルミ 雪平鍋(ビス止め)

	ID×H (mm)	(ℓ)	Thickness(mm)	
● 15cm :	150×60	0.8	1.7	31-0032-0401
● 18cm :	180×70	1.4	1.7	31-0032-0402
● 20cm :	200×75	1.8	1.8	31-0032-0403
● 21cm :	210×80	2.2	2.0	31-0032-0404
● 24cm :	240×90	3.2	2.4	31-0032-0405
● 27cm :	270×110	5.1	2.7	31-0032-0406

This all-purpose pan is used for stewing and boiling



5 Copper Milk Pot

銅 ミルクパン

● 31-0032-0501

Size (mm) : φ135×H70
Capacity : 0.75 ℓ

This pan is easy to pour from, and convenient when cooking for one. It has a higher thermal conductivity than aluminum and is suited to heating up soups and stews.



6 YATTOKO Hammerd Aluminium Cooking Pot

アルミ ヤットコ鍋

	OD (mm)	(ℓ)	
● 18cm :	180×75	1.6	31-0032-0601
● 21cm :	210×85	2.5	31-0032-0602
● 24cm :	240×100	4.5	31-0032-0603
● 27cm :	270×110	6.4	31-0032-0604
● 30cm :	300×130	9.0	31-0032-0605

- ・ This pan is convenient because can be placed on high temperature burners without burning the handle
- ・ It is convenient when cooking with multiple pans because the handle will not get in the way



7 YATTOKO Cooking Pot Pincers

矢床バサミ(クローム)

● L : 31-0032-0701

Size (mm) : 240



The name "Oyakoko" (parent and child) is derived from the combination of chicken and eggs. This pan is designed exclusively for making "Oyakodon" for which chicken is stewed in an egg soup and placed on top of rice.



1 Lid for OYAKO Pan

アルミ 親子鍋用 蓋

OD (mm)

- 16.5cm : 160 31-0033-0101
- 18cm : 170 31-0033-0102

2 Aluminium OYAKO Pan

アルミ 親子鍋

ID×H (mm) (φ) Thickness(mm)

- 16.5cm : 162×22 0.3 1.5 31-0033-0201
- 18cm : 180×24 0.4 1.5 31-0033-0202

3 Aluminium OYAKO Pan Deep Type

アルミ 親子鍋 深型 立柄

ID×H (mm) (φ) Thickness(mm)

- 16.5cm : 162×31 0.5 1.5 31-0033-0301
- 18cm : 180×31 0.6 1.5 31-0033-0302

KYS IRON PAN SERIES

Iron has high heat retention and is ideal for cooking at high heat and for when you need to quickly heat the oil and all ingredients such as when stir-frying.

These products have an anti-corrosive membrane over their iron surface, so they are rust resistant, durable, and season superbly.



4 KYS Iron Frying Pan

KYS 鉄黒皮 厚板フライパン

ID×H (mm)

- 18cm : 180×37 31-0033-0401
- 20cm : 200×40 31-0033-0402
- 22cm : 220×43 31-0033-0403
- 24cm : 240×46 31-0033-0404
- 26cm : 260×49 31-0033-0405
- 28cm : 280×52 31-0033-0406

Thickness : 2.3 mm

- This pan is also suitable for IH hot-plates
- It has an extra thick base to distribute heat evenly and prevent deformation even after years of use.



5 KYS Iron Peking Wok Pan

KYS 鉄 北京鍋

Thickness(mm) H (mm) (g)

- 30cm : 1.2 88 1,010 31-0033-0501
- 33cm : 1.2 99 1,200 31-0033-0502
- 36cm : 1.2 109 1,510 31-0033-0503

- The pan and the handle are a single unit, which enables it to withstand rough treatment.
- The surface is porous, which means the seasoning improves the more you use it.



6 KYS Iron Wok Pan

KYS 鉄 中華鍋

Thickness(mm) H (mm) (g)

- 33cm : 1.2 89 1,130 31-0033-0601
- 36cm : 1.2 99 1,430 31-0033-0602
- 39cm : 1.2 109 1,550 31-0033-0603

- The shape of this pan allows for excellent heat distribution.
- This wok is black because it is made from black iron, which has excellent heat absorption.
- The surface is porous, which enables it to be seasoned well.



7 Titanium Peking Wok Pan

チターナ 北京鍋 (チタン製)

Thickness(mm) H (mm) (g)

- 33cm : 1.2 100 660 31-0033-0701
- 36cm : 1.2 110 775 31-0033-0702

- Extremely light, with outstanding corrosion resistance
- Even at low temperatures, the pan heats up, allowing you to cook quickly.
- Titanium is much lighter than iron, which alleviates the strain on your arms and wrists due to frequent use.



8 Ladle for Wok Pan

18-0 木柄/パイプ 中華お玉

OD (mm) Handle(mm)

- M : φ120 365 31-0033-0801

9 Spatula for Wok Pan

18-0 中華ヘラ

L×W (mm) Handle(mm)

- L : 128×100 380 31-0033-0901
- S : 105×85 380 31-0033-0902

10 Bamboo Wok Cleaner

竹ささら

- 31-0033-1001

Size (mm) : 235

- This is used for scrubbing and cleaning woks.



1 Stainless Soup Filter

18-8 スープこし

ID×H (mm) (mm)

- 24cm : 240×220 225 31-0034-0101

※ Contains φ1mm holes

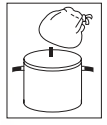

2 KYS Making Stock Bag [DASHIKOSHI-FUKURO]

KYS だしこし袋

W×H (mm)

- 26×28cm : 260×280 31-0034-0201
- 37×40cm : 370×400 31-0034-0202
- 42×44cm : 420×440 31-0034-0203

Material : Polyester (Fabric)
Heat resistant up to : 200℃~220℃



3 Bonito Shaver

手動かつお節削り機

- 31-0034-0301

Size (mm) : W205×D192×H261
Weight : 985 g

- Just clamp it in and turn the handle. Shave bonito with ease.
- The suction cups on the bottom allow you to shave bonito from a stable base.
- Use the movable stopper to shave the bonito until it is almost used up, without adjusting the size and shape.
- The blade is replaceable, so there is no need to waste time adjusting it.



4 Bonito Shaver Box

鯉節削箱

- 31-0034-0401

Size (mm) : W250×D100×H110



5 Wooden Handle Sieve

ステンレス ローズ柄ストレーナー (18-8アミ・16メッシュ)

ID×H (mm) Handle(mm)

- 16cm : 160×H70 155 31-0034-0501
- 20cm : 200×H100 155 31-0034-0502
- 25cm : 250×H100 155 31-0034-0503

- The natural wood handle is easy to grip

6 Stainless Handle Sieve

ステンレス プロストレーナー (18-8アミ・16メッシュ)

ID×H (mm) Handle(mm)

- 17.5cm : 175×H70 201 31-0034-0601
- 25cm : 250×H95 208 31-0034-0602
- 30cm : 300×H105 260 31-0034-0603

Material : 100% stainless steel



7 Miso Strainer with Ladle (Wire Handle)

18-8 共柄みそこし (スプーン付・16メッシュ)

- 31-0034-0701

Size (mm) : φ110×H215

Includes a hook to attach to the edge of the pot, and a convenient ladle.



8 Miso Strainer (Big Size)

ステンレス プロみそこし (18-8アミ・16メッシュ)

- 31-0034-0801

Size (mm) : φ170×H110 Handle length : 220 mm

- Includes a hook to attach to the edge of the pot.

Anti-Bacterial High-Tech Spatulas Heat resistant up to 130°C

- The smooth surface eliminates crevices that catch food, making these spatulas easy to clean!
- The ultra-high molecular weight polymer (created using UMSP) ensures exceptional friction and shock resistance.
- Will not scratch the base of the pan! ● The handle will not get hot!



1 Anti-Bacterial[Kokin]High-Tech Spatula (Round Type)

抗菌ハイテク・スパテラ(丸)

	L×W (mm)	(g)	
●SPO-40	: 400×111	190	31-0035-0101
●SPO-60	: 600×137	360	31-0035-0102
●SPO-90	: 900×163	720	31-0035-0103
●SPO-120	: 1,200×187	1,200	31-0035-0104
●SPO-150	: 1,500×215	1,950	31-0035-0105

2 Anti-Bacterial[Kokin]High-Tech Spatula (Square Type)

抗菌ハイテク・スパテラ(角)

	L×W (mm)	(g)	
●SPS-40	: 400×80	190	31-0035-0201
●SPS-60	: 600×105	380	31-0035-0202



3 Wooden Spatula

東型杓子 丸型(主材:ブナ)

	L×W (mm)	
●No. 8.5	: 255×82	31-0035-0301
●No. 10	: 300×92	31-0035-0302
●No. 12	: 357×100	31-0035-0303
●No. 14	: 425×110	31-0035-0304
●No. 16	: 482×117	31-0035-0305
●No. 18	: 545×133	31-0035-0306
●No. 20	: 602×133	31-0035-0307



4 Stainless Kitchen Pot

18-8 深型キッチンポット(目盛付)

	ID×H (mm)	(ℓ)	
●10cm	: 100×100	0.7	31-0035-0401
●12cm	: 120×120	1.4	31-0035-0402
●14cm	: 140×140	2.1	31-0035-0403
●16cm	: 160×160	3.3	31-0035-0404



5 Stainless Square Kitchen Pot

18-8 目盛付角キッチンポット

	H (mm)	(ℓ)	
●10.5cm	: 105	1.1	31-0035-0501
●12cm	: 120	1.6	31-0035-0502
●15cm	: 150	3.1	31-0035-0503

This is the most popular type, and it has good corrosion resistance



6 Mini Stainless YAKUMI Pan

18-8 ミニ調味料入パット(伸子ミニ号)

	W×D×H (mm)	
●6 type	: 328×148×H63	31-0035-0601
●8 type	: 432×148×H63	31-0035-0602

Mini Condiment holder : 105×68×H59



7 Stainless YAKUMI Pan

18-8 調味料入パット(伸子0号)

	W×D×H (mm)	
●2 type	: 224×149×H63	31-0035-0701
●4 type	: 432×148×H63	31-0035-0702
●6 type	: 327×286×H63	31-0035-0703

Condiment holder : 137×106×H61



8 Stainless Shallow Colander

18-8 ザル(14メッシュ)

	OD×H (mm)	
●18cm	: 198×H90	31-0035-0801
●22.5cm	: 243×H102	31-0035-0802
●25cm	: 266×H109	31-0035-0803★
●30cm	: 318×H120	31-0035-0804★

★ Includes reinforcing bands



10 Stainless Deep Colander

ステンレス 米揚ザル(12メッシュ)

	OD×H (mm)	
●L (8 sho = 14.7ℓ)	: 400(373)×H220	31-0035-1001
●M (5 sho = 9.1ℓ)	: 340(316)×H200	31-0035-1002
●S (3 sho = 5.4ℓ)	: 300(266)×H160	31-0035-1003

Includes reinforcing bands
· Ideal for washing rice



9 Stainless Shallow Colander (Large Type)

18-8 浅型ザル(11メッシュ)

	OD×H (mm)	
●35cm	: 370×H135	31-0035-0901
●40cm	: 430×H165	31-0035-0902
●43cm	: 458×H180	31-0035-0903
●46cm	: 488×H187	31-0035-0904

Includes reinforcing bands



11 Bamboo BONZARU Strainer

竹製 丸盆ザル

●24cm	: 31-0035-1101
●42cm	: 31-0035-1102

Using a tray such as this is common in Japan when storing food in the freezer or refrigerator, or when placing it on the bench to cook. We stock many sizes and materials such as aluminum and stainless steel.



1 18-8 Stainless Vat
18-8 角バット

W×D×H (mm)		
●No.12	: 322×252×53	31-0036-0101
●No.15	: 296×231×49	31-0036-0102
●No.18	: 266×205×43	31-0036-0103
●No.21	: 248×202×37	31-0036-0104
●Cabinet	: 210×170×31	31-0036-0105
●Card sized	: 187×142×30	31-0036-0106
●Wallet sized	: 155×126×27	31-0036-0107



2 Aluminium Vat
アルミ 標準バット

W×D×H (mm) Thickness(mm)		
●No.1	: 370×307×45	0.8 31-0036-0201
●No.2	: 348×273×38	0.8 31-0036-0202
●No.3	: 312×241×35	0.7 31-0036-0203
●No.4	: 276×211×35	0.7 31-0036-0204
●No.5	: 242×181×30	0.65 31-0036-0205
●No.6	: 210×150×29	0.65 31-0036-0206
●No.7	: 189×132×27	0.65 31-0036-0207
●No.8	: 160×109×27	0.6 31-0036-0208

High heat conductivity allows for fast freezing and thawing.



3 18-8 Stainless Deep Vat
18-8 深型組バット

W×D×H (mm)		
●Mini type	: 105×68×59	31-0036-0301
●M0 type	: 122×87×59	31-0036-0302
●0 type	: 137×106×61	31-0036-0303
●S type	: 162×111×67	31-0036-0304
●1 type	: 179×119×69	31-0036-0305



4 Aluminium Meat Vat
アルミ 肉バット

W×D×H (mm)		
●400 g large	: 420×310×25	31-0036-0401
●Slotted large	: 414×304×24	31-0036-0402

Thickness 1.0 mm



5 Aluminium Stacking Vat
アルミ システムバット

W×D×H (mm)		
●L50	: 414×312×50	31-0036-0501
●S50	: 346×266×50	31-0036-0502

Thickness 1.0 mm



The lock and key construction means that they will not slip, even when stacked

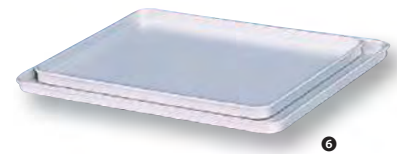

6 Lid for Aluminium Stacking Vat
アルミ システムバット蓋

W×D×H (mm)		
●L	: 422×320×16	31-0036-0601
●S	: 356×276×16	31-0036-0602

Thickness 1.0 mm

Thermal Rice container Wash Heat resistant from : 0°C ~ 80°C

Long life

The polypropylene resin that is used for the interior and exterior of our thermal rice containers is the same plastic that is used in plastic buckets and beer crates, and it is exceptionally strong. It is also extremely durable, and this is another reason that this material was chosen for the thermal rice containers. The thermal rice container, which is encased in this polypropylene, is a long life product that will not break, even after years of use.

Lightness and usability

Our thermal rice containers were designed with usability in mind. With its compact dimensions, and its lightness, it can be handled easily, even by women.

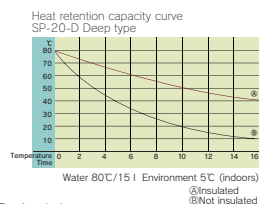
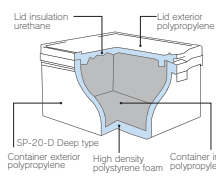

Material : Body / PP + insulation Lid / PP + insulation



7 Thermal Rice Container SP-20D
エスレンコンテナ SP-20-D深型

● 31-0036-0701

Size (mm) : OD W483×D373×H256 ID W372×D305×H180
Weight : 2.9 kg
Capacity : 9ℓ / 5 sho



8 Plastic Rice Container Tray
エスレンコンテナ SPトレイ

● 31-0036-0801

Size (mm) : OD W370×D300×H31 ID W367×D294×H28
・SP-20-D Depth creates space for 5



1 Soba Strainer(Horizontal Bamboo Handle)

ステンレス 竹柄 そば揚 厚網ヨコ型 (18-8アミ・6.5メッシュ)

OD (mm) Handle (mm)

● 24cm : 240 270 31-0037-0101

- Sturdy design with thickly woven thick wires.
- Simple and durable.

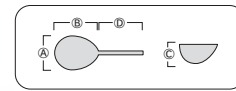

2 Noodle Strainer(Wooden Handle)

ステンレス 木柄 プロすいのう (18-8アミ・6.5メッシュ)

Size (mm)

● XL : A250×B280×C77×D370 31-0037-0201
● L : A220×B255×C77×D370 31-0037-0202

- Sturdy design with thickly woven thick wires.
- Simple and durable.

3 Noodle Strainer(Stainless Pipe Handle)

ステンレス パイプ柄 プロすいのう (18-8アミ・6.5メッシュ)

Size (mm)

● XL : A250×B280×C77×D345 31-0037-0301
● L : A220×B255×C77×D345 31-0037-0302

Unbelievably light!! Greatly reduces effort



This product uses a polyester mesh, with incredible lightness and straining capability. It is quick to dry and hygienic.

4 Sanuki Udon Landing Net(SANUKI TAMO)

木柄 讃岐たも

OD×H (mm) Handle (mm)

● L : 360×500 380 31-0037-0401
● M : 300×450 380 31-0037-0402

Material : Frame and winding wires / 18-8 stainless steel
Wooden Handle / natural wood
Mesh / polyester

- We have achieved excellent lightness and drainage by using a polyester mesh.
- Drying is fast and hygienic.
- The mesh is attached with fasteners, so it is easy to remove and attach.



5 Soba Colander

ステンレス そばすくい網 (18-8アミ・10メッシュ)

OD×H (mm) Handle (mm)

● 36cm : 360×125 230 31-0037-0501
● 39cm : 390×130 230 31-0037-0502

- Thick and durable metal mesh.
- Easy to carry oval pipe.

Withstands vigorous shaking
Unbelievable durability



■ Comparison of wire thickness
Power strainer Conventional strainers



● We made the neck, which is the weakest point of straining baskets, thicker (5mm).

This part is strong!



6 Noodle Power Strainer (Zelkova Handle)

ステンレス ラーメン専用パワーては丸底 (18-8アミ・8メッシュ)

● 31-0037-0601

Size (mm) : 140×H150
Handle Size : 220 mm



Board edge height = 17 mm.
Prevents boiling over

7 Noodle Strainer (Wooden Handle)

ステンレス 丸木柄 うどんては (18-8アミ・8メッシュ)

● 31-0037-0701

Size (mm) : 140×H160
Handle Size : 185 mm



Board edge height = 24 mm.
Prevents boiling over

8 Noodle Strainer Deep Type (Wooden Handle)

18-8 ローす柄 深型うどんては (8メッシュ)

● 31-0037-0801

Size (mm) : 140×H180
Handle Size : 215 mm



9 Spaghetti Strainer (Wooden Handle)

ステンレス 木柄スパゲティ揚 (18-8アミ・16メッシュ)

OD×H (mm) Handle (mm)

● L : 150×230 190 31-0037-0901
● S : 130×190 190 31-0037-0902



10 Flat Bottom Noodle Strainer (Wire Handle)

ステンレス 共柄平底 ては (18-8アミ)

OD×H (mm) Handle (mm)

● L : 190×145 175 31-0037-1001
● S : 150×130 145 31-0037-1002

- Large : 10 mesh Small : 8 mesh
- Sturdy frame construction
- Freestanding type that can be placed in the bottom of the pan.

Use as a bowl for kneading udon, soba, and bread dough



1 ABS Konebachi Kneading Bowl

尺2 ABS こね鉢 外黒内朱天黒

● 31-0038-0101

Size (mm) : φ360×H95
Material : ABS resin

2 Melamine Konebachi Kneading Bowl

尺5 厚口こね鉢 内朱天黒

● 31-0038-0201

Size (mm) : φ452×H105
Material : Melamine resin

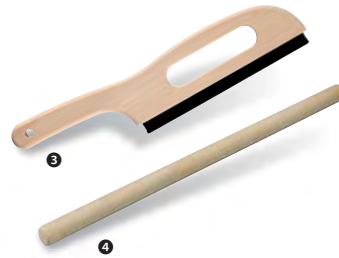

3 Soba Buckwheat Flour Brush

そば・粉用はけ

● 31-0038-0301

Size (mm) : 350
Pristles : 35 mm
Material : Handle / beech
Bristles / black azlon (66 nylon)



4 Oak Making Noodle Stick

檜めん棒

L (mm)

- No.20 : 600 31-0038-0401
- No.25 : 750 31-0038-0402
- No.30 : 900 31-0038-0403
- No.40 : 1,200 31-0038-0404



Simply cut the dough to your desired width and thickness.
"The roller" has 4 thickness settings (1~2.5 mm).
There are 3 types of "noodle cutters" (2,3,4 mm).

Easy to Wash Stainless

Dismantling is possible
The cutter is easy to dismantle, which allows you to hygienically wash it in water.

Rust-proof
The main body is made from stainless steel and resin and the cutter is made from resin, so it will not rust, even if you wash it.

Compact
Light enough to hold in one hand.
Outstanding storability



5 Washable Noodle-making Machine MCS203

洗える製麺機

● 31-0038-0501

Size (mm) : 170×140×H220 Weight : 2.0 kg
Attached cutter : 2 mm , 3 mm , 4 mm
Accessories : Handle, clamp

・ Cut the dough to the desired width and thickness with 2 cutters.



- The body is cast iron, which provides good stability and allows you to simply and enjoyably create professional quality noodles.
- The blade rollers and the rolling pins are made from stainless steel, so they have outstanding durability, cleanliness, and rust resistance.
- Can be used for udon, soba, ramen, and pasta.
- The standard blade roller cuts the noodles to 2 mm. (Noodles expand slightly when boiled.)
- The main body comes with an adjuster to allow for easy set-up.

Roll the dough

Cut the dough



6 Noodle-making Machine

製麺機

● 31-0038-0601

・ Size (mm) : 300×290×H280 Weight : 11 kg
Attached Cutter : 2 mm
Cutter Width : 112 mm

・ Material Blade roller, rolling pin : Stainless steel Frame, handle : Cast iron
・ Guide : Natural wood Handle : ABS resin

TEMPURA POT

Before the advent of the gas and electric fryers, these pots offered an efficient and economical way to produce perfect TEMPURA. The large surface area maximizes the use of a given amount of oil and leaves more than ample room for properly frying multiple pieces at a time.



1 KYS Iron Tempura Pot
KYS 鉄 揚鍋

	H (mm)	(ℓ)	(kg)	
●39cm :	92	10.9	4.80	31-0039-0101
●42cm :	103	13.2	5.70	31-0039-0102
●45cm :	120	16.7	6.29	31-0039-0103

Thickness : 3.2 mm

Heavy, durable pots that offer an economical choice for frying on electric or gas stove tops.

- The base is extremely thick at 3.2 mm in order to prevent sudden drops in oil temperature.
- Create crisp and delicious fried food with exceptional heat retention.



2 Copper Tempura Pot
銅 揚鍋

	H (mm)	(ℓ)	(kg)	
●36cm :	85	8.0	2.95	31-0039-0201
●39cm :	95	9.0	3.50	31-0039-0202
●42cm :	105	11.5	4.05	31-0039-0203
●45cm :	115	14.5	5.20	31-0039-0204

Beautifully designed pots using the most heat conductive metal to ensure the best control over oil temperature.



3 Tempura(Deep-fry)Thermometer
揚げもの用温度計

● 31-0039-0301

Size (mm) : φ43×H145
Display range : 20 ~ 220 °C
Minimum increment : 5 °C

※Do not wash with water under any circumstances.



4 Stainless Tempura Vat
18-0 角天台

● L : 31-0039-0401

Size (mm) : W458×D307×H73



5 Stainless Wooden Handle Cooking Chopsticks (Manabashi)

ステンレス マナ箸 (水牛柄) (盛箸)

L (mm)	
●120 :	265 31-0039-0501
●150 :	290 31-0039-0502
●165 :	310 31-0039-0503
●180 :	320 31-0039-0504



6 Bamboo Cooking Chopsticks (Saibashi)

竹製 菜箸

●33cm : 31-0039-0601

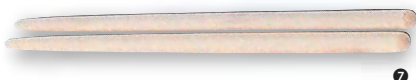

7 Tempura Flour Mixing Chopsticks (Hanabashi)

花箸

●37cm : 31-0039-0701



8 Red Cooking Chopsticks

カブキ箸

●33cm : 31-0039-0801



9 Cooking Chopsticks 3piece Set

菜箸 3本組

● 31-0039-0901

Size : 27cm · 30cm · 33cm



1 Stainless Kakiage Deep-Frying Ring
18-8 パンチングかき揚げリング

- 31-0040-0101
- Size (mm) : $\phi 100 \times H50$
- Handle : 270 mm
- Hole diameter : $\phi 4.8$ mm



2 Non-stick Kakiage Deep-Frying Ladle
フッ素加工 2連式かき揚げレードル

- 31-0040-0201
- Size (mm) : $W250 \times D120 \times H342$
- Material : Interior surface / fluoric resin coated aluminium
- Exterior / anodized aluminium
- $\phi 120$ mm each

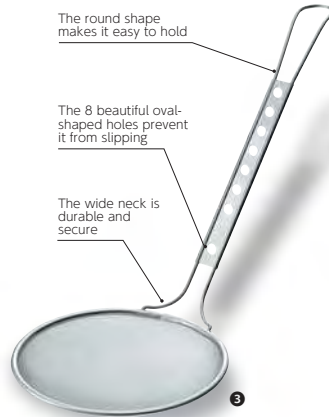

3 Round Kasuage Mesh Skimmer
ステンレス 丸カス撮

- OD×H (mm)
- 15cm : 150×260 31-0040-0301
 - 18cm : 180×265 31-0040-0302
- Material : Stainless steel mesh fine 40 mesh



4 Square Kasuage Mesh Skimmer
ステンレス プレス角カス撮

- W×D (mm) handle(mm)
- L : 160×168 270 31-0040-0401
 - M : 142×180 250 31-0040-0402
 - S : 125×128 225 31-0040-0403
- Fine 40 mesh



5 Stainless Oil Filter
18-0 強力油こし

- OD×H (mm)
- No.4 : 235×75 31-0040-0501
 - No.5 : 275×87 31-0040-0502



6 Stainless Oil Pot
18-8 オイルポット

- OD×H (mm)
- 2 ϕ : 140×140 31-0040-0601
 - 3 ϕ : 160×160 31-0040-0602
- Mesh : 2 ϕ ・3 ϕ (40 mesh)



7 Stainless Tempura Lees Pot
18-8 天ぷらカス入

- OD×H (mm)
- L : 220×230 31-0040-0701
 - M : 190×180 31-0040-0702



1 Stainless Square Steamer(Kakumushi) 3levels

18-8 業務用 角蒸器

	W×D×H (mm)	cup / 1level (chawan)	Quantity of rice	
● 30cm :	300×300×125	9	3.6 ㍓ (2.0 sho)	31-0041-0101
● 33cm :	330×330×125	10	4.3 ㍓ (2.4 sho)	31-0041-0102
● 36cm :	360×360×125	11	5.0 ㍓ (2.8 sho)	31-0041-0103
● 39cm :	390×390×125	16	5.8 ㍓ (3.2 sho)	31-0041-0104

Top of the line Professional steamer for use over gas, with removable base in each tier for easy cleaning.



2 Aluminium Square Steamer(Kakumushi) 2levels

アルミ 角蒸 (大型)

Quantity

● 30cm : 10.8 ㍓ (2.5 sho) 31-0041-0201

・ A thickness of 1.1 mm prevents warping, which can cause steam to leak.



4 Stainless Egg Tofu Mold

18-8 業務用 玉子豆腐器 関東型

W×D×H (mm)

- 15cm : 150×150×40 31-0041-0401
- 18cm : 180×180×40 31-0041-0402
- 21cm : 210×210×40 31-0041-0403
- 24cm : 240×240×44 31-0041-0404



3 Steaming Cloth

ふかし布

W×L (mm)

- M : 700×700 for 3.6~5.4 ㍓ (2~3 sho) 31-0041-0301
- L : 900×900 for 7.2~9.0 ㍓ (4~5 sho) 31-0041-0302

Material : 100% Cotton

・ Using a steaming cloth prevents food from sticking to the tray or basket, and allows you to easily remove the food without it losing its shape.



5 Cedar Steamer

杉製 中華セイロ 身

ID×H (mm)

- φ13cm : 112×38 31-0041-0501
- φ15cm : 132×43 31-0041-0502
- φ18cm : 164×42 31-0041-0503
- φ21cm : 192×41 31-0041-0504
- φ24cm : 217×49 31-0041-0505
- φ27cm : 258×45 31-0041-0506
- φ30cm : 280×55 31-0041-0507

6 Lid for Cedar Steamer

杉製 中華セイロ 蓋

ID×H (mm)

- φ13cm : 123×23 31-0041-0601
- φ15cm : 141×30 31-0041-0602
- φ18cm : 172×30 31-0041-0603
- φ21cm : 202×31 31-0041-0604
- φ24cm : 230×32 31-0041-0605
- φ27cm : 258×45 31-0041-0606
- φ30cm : 288×45 31-0041-0607



7 Separate Paper (500 Sheets/Pack)

旭化成 クックパーセパレート紙(500枚入)

ID×H (mm)

- M-11 : 110 31-0041-0701
- M-14 : 140 31-0041-0702
- M-18 : 180 31-0041-0703

・ Ensures food to be presented cleanly, without sticking together.



8 Separate Paper Panching Type (500 Sheets/Pack)

旭化成 クックパー穴明きセパレート紙(500枚入)

OD (mm)

- AM-13 : 130 31-0041-0801
- AM-15 : 150 31-0041-0802

・ Allows steam to pass through it, while ensuring food is presented cleanly, without sticking together.



9 Wooden Basket Steamer

木製 角セイロ 関東型 (サワラ材)

OD (mm) ID (mm) Capacity

- 39cm : 530×530 395×395 6.3 ㍓ (3.5 sho) 31-0041-0901
- 45cm : 590×590 455×455 9 ㍓ (5.0 sho) 31-0041-0902

Height : 120 mm Depth : 100 mm



10 Bamboo Mat for Basket Steamer

角セイロ用 竹スダレ

- 39cm : 31-0041-1001
- 45cm : 31-0041-1002

* Baskets are sold separately.

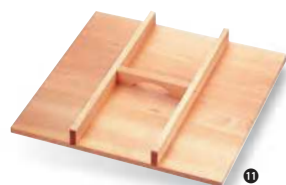

11 Wooden Lid for Steamer

木製 角セイロ用 手付蓋 (サワラ材)

L×W (mm)

- 39cm : 480×480 31-0041-1101
- 45cm : 540×540 31-0041-1102

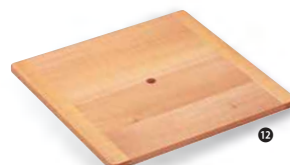

12 Bottom Board for Basket Steamer

木製 角セイロ用 台す (サワラ材)

L×W (mm)

- 39cm : 480×480 31-0041-1201
- 45cm : 540×540 31-0041-1202

Hole diameter : Approximately 20 mm

The clip-on frame makes it easy to change the mesh, enabling multiple applications.



1 Refillable Strainer

18-8 ワンタッチうらごし枠(本体)

H (mm)

- 31cm : 105 31-0042-0101

Mesh is sold separately

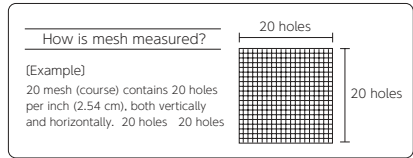

2 Refill Mesh for Strainer

18-8 替アミ (31cm用)

Mesh Size (mm)

- 7 mesh (for breadcrumbs) : 3.05 31-0042-0201
- 12 mesh (for sugar) : 1.72 31-0042-0202
- 20 mesh (course) : 0.89 31-0042-0203
- 30 mesh (medium) : 0.56 31-0042-0204
- 50 mesh (fine) : 0.28 31-0042-0205
- 65 mesh (silken tofu) : 0.21 31-0042-0206



3 Stainless Ladle with Hole Wooden Handle

木柄レードル 穴明

- 31-0042-0301

Size (mm) : φ113×330



5 Stainless Ladle

18-8 スープレードル

φ (mm) Handle(mm)

- 30cc : 53 230 31-0042-0501
- 90cc : 73 250 31-0042-0502
- 150cc : 89 280 31-0042-0503
- 180cc : 93 280 31-0042-0504



6 Stainless Ladle (Side Pouring Type)

18-8 横口レードル

L×W (mm) Handle(mm)

- 50cc : 97×67 250 31-0042-0601
- 70cc : 103×71 250 31-0042-0602
- 90cc : 112×75 250 31-0042-0603



7 Stainless Ladle

18-8 カンロレードル

(mm) Handle(mm)

- 18cc : 35 205 31-0042-0701
- 27cc : 40 205 31-0042-0702

4 Stainless Ladle with No Hole Wooden Handle

木柄レードル 穴無

- 31-0042-0401

Size (mm) : φ113×330



Features of "Clever Tongs"

- The tips are thin, which makes it easy to pick up items such as layers of sliced ham.
- The tips do not touch the table, which makes them hygienic, and perfect for barbecuing.

8 Stainless Clever Tongs

18-0 クレーバートングエコノミータイプ

- 31-0042-0801

Size (mm) : 240
Satin finish
・ Light type.

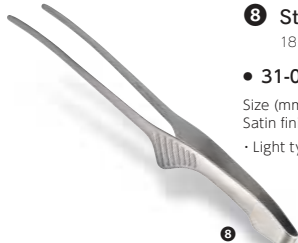

Made in TSUBAME

9 Stainless Safety Tongs

18-0 セーフティリーフトング

L (mm)

- 20cm : 200 31-0042-0901
- 24cm : 240 31-0042-0902

10 Stainless Safety Salad Tongs

18-0 セーフティサラダトング

L (mm)

- 20cm : 200 31-0042-1001
- 24cm : 240 31-0042-1002



11 Stainless Spaghetti Tongs

18-0 スパゲティトング

- 31-0042-1101

Size (mm) : 200

Features of the Safety Tongs Series

- By using a special process to make the metal thinner, we have created tongs that can be gripped lightly and softly.
- Hygienic and easy to wash due to the single part construction.





1 Bamboo Tongs
竹トング

- 31-0043-0101
- Size (mm) : 180



2 Tempura Tongs
18-0 天ぷらトング

- 31-0043-0201
- Size (mm) : 230
- ・ Ideal as barbeque tongs.

3 Lemon Tongs
18-0 レモントング

- 31-0043-0301
- Size (mm) : 95
- ・ Ideal as Gari (Ginger Pickles in Vinegar) tongs

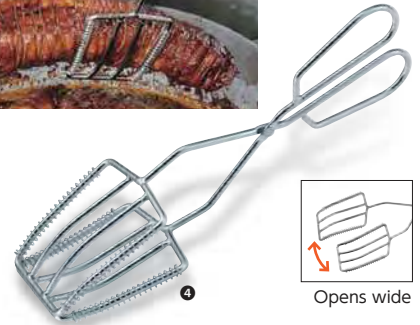

4 Chashao(Roast Pork) Tongs
ステンレスチャーシュートング

- 31-0043-0401
- Size (mm) : 300
- Grasping ends : 70×100 mm
- ・ Grip chashao(roast pork) without it losing its shape.

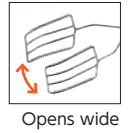

5 Dispenser
ティスベンサー(白)

- D×H (mm)
- 270cc(240cc) : 50×185 31-0043-0501
 - 360cc(330cc) : 55×205 31-0043-0502
 - 400cc(380cc) : 58×210 31-0043-0503

Material : Polyethylene
The capacity shown in brackets is the actual capacity.



6 Dispenser 720cc
ティスベンサー 720cc(白)(目盛付)

- 31-0043-0601
- Size (mm) : 70×H253
- Material : Polyethylene

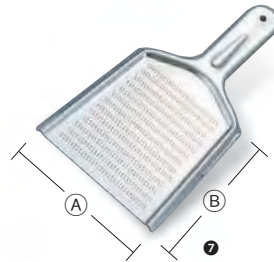

7 Stainless Grater
ステンレス オロシ金

- Size (mm)
- No.1 : (A)168×(B)152 31-0043-0701
 - No.2 : (A)165×(B)132 31-0043-0702
 - No.3 : (A)130×(B)142 31-0043-0703
 - No.4 : (A)128×(B)127 31-0043-0704
 - No.5 : (A)105×(B)120 31-0043-0705

No. 1, 2, 3 and 4 are bi-directional, whereas No. 5 is mono-directional.



10 Shark Skin Grater
サメ皮オロシ

- L×W (mm)
- L : 85×80 31-0043-1001
 - M : 68×62 31-0043-1002
 - S : 53×52 31-0043-1003

・ Grate wasabi smoothly.

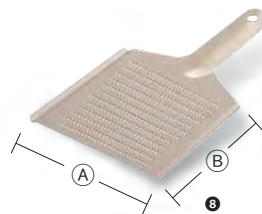

8 Aluminium Grater
板オロシ金(硬質アルミ)

- Size (mm) Thickness
- XL : (A)170×(B)155 2.2 31-0043-0801

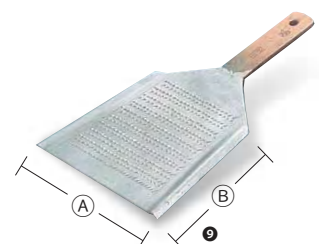

9 Copper Grater
銅 オロシ金

- Size (mm)
- No.6 : (A)100×(B)105 31-0043-0901
 - No.20 : (A)200×(B)170 31-0043-0902

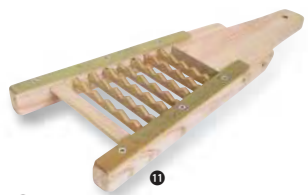

11 Wooden Oroshi Grater
木製 鬼おろし(平)

- L×W (mm)
- L : 330×130 31-0043-1101

・ Create coarsely grated daikon with texture.



1 SURIBACHI Grinding Bowl

スリ鉢

D (mm)

- No.6 : 190 31-0044-0101
- No.7 : 220 31-0044-0102
- No.10 : 310 31-0044-0103
- No.15 : 460 31-0044-0104

2 Wooden Grinding Stick

進木(すりこぎ棒)

L (mm)

- No.6 : 180 31-0044-0201
- No.8 : 240 31-0044-0202
- No.12 : 360 31-0044-0203
- No.15 : 450 31-0044-0204
- No.18 : 540 31-0044-0205
- No.20 : 600 31-0044-0206



3 Ginkgo Nut Splitter

鉄ギンナン割(スタンダード)

- 31-0044-0301

Size (mm) : 175



4 Stainless Roast Net

ステンレス 炒り網(18-8アミ・24メッシュ)

D×H (mm) Handle(mm)

- 13cm : 130×H40 170 31-0044-0401
- 16cm : 160×H52 170 31-0044-0402

・ Use for roasting green coffee beans, ginkgo nuts, and sesame seeds.



5 KYOCERA Ceramic Vegetable Peeler

京セラ セラミック 斜めピーラー-CP-NA09

- 31-0044-0501

Size (mm) : W84×L155

- ・ The fine ceramic blade means the edge stays sharp with minimal abrasion.
- ・ Stays clean and won't rust.
- ・ The fine ceramic blade does not produce a metallic taste (metallic ions), keeping your fruit and vegetables free from metallic aftertaste.
- ・ The angle of the diagonal blade is sharp, ensuring an exceptional cutting edge



6 Anti bacterial Grips Scissors

抗菌柄 キッチンバサミ

- 31-0044-0601

Size (mm) : 200

・ Easy to disassemble and wash.



7 Kitchen Scissors

キッチンバサミ

- 31-0044-0701

Size (mm) : 204



8 Crab Scissors

カニ専用バサミ

- 31-0044-0801

Size (mm) : 210

- ・ Use these scissors for cutting crab.
- ・ Use the base of the handle to break the shell.
- ・ Use the tips of the scissors to extract the meat, making this an all-in-one tool for eating crab.
- ・ The handle is made from a soft resin, which will not place strain on your hands, even when cutting hard shells or legs.



VEGETABLE CUTTERS



9 UME(3pcs) (Apricot Blossom)

梅 3pcs

- 31-0044-0901



11 MOMIJI(3pcs) (Maple)

紅葉 3pcs

- 31-0044-1101



10 SAKURA(3pcs) (Cherry Blossom)

桜 3pcs

- 31-0044-1001



12 KIKU(3pcs) (Chrysanthemum)

菊の花 3pcs

- 31-0044-1201



13 4pcs Assorted 18-8 野菜抜型 4pcs

D (mm)

- L : φ35 31-0044-1301
- S : φ25 31-0044-1302

RICE MOLDS

When making sushi or onigiri, rice ball, it is ideal if they are shaped by a skilled chef, however by using these molds, you can create large quantities of sushi and onigiri with a uniform shape, without relying on an expert. You can even use freshly cooked rice hygienically and without burning yourself.

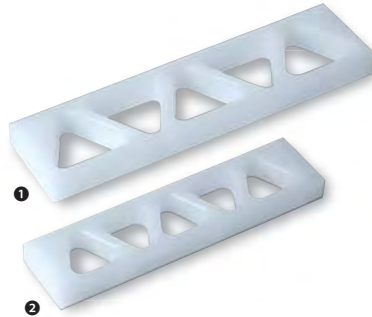

1 Heavy-Duty Plastic ONIGIRI Mold

おにぎり型 A(関西型)

- | | Rice weight (g) | finished Size (mm) | |
|---------------|-----------------|--------------------|--------------|
| ● L Makes 5 : | 90 | 83×75×H30 | 31-0045-0101 |
| ● S Makes 5 : | 70 | 70×60×H30 | 31-0045-0102 |

The large size has a 5 mm taper.

2 Heavy-Duty Plastic MINI ONIGIRI Mold

プチおにぎり型

- | | Rice weight (g) | finished Size (mm) | |
|-------------|-----------------|--------------------|--------------|
| ● Makes 5 : | 40 | 50×50×H25 | 31-0045-0201 |

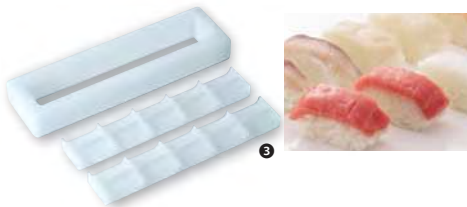

3 Heavy-Duty Plastic NIGIRI SUSHI Mold

にぎり寿司

- | | Rice weight (g) | finished Size (mm) | |
|----------------|-----------------|--------------------|--------------|
| ● L Makes 10 : | 25 | 55×23×H20 | 31-0045-0301 |
| ● M Makes 10 : | 23 | 50×23×H20 | 31-0045-0302 |
| ● S Makes 10 : | 20 | 45×23×H20 | 31-0045-0303 |

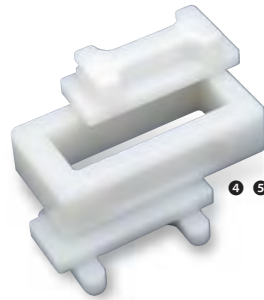

Because the mold is made from a single piece it has no gaps and is easy to clean and disinfect. The upper mold, the frame, and the lower mold have each been milled from a single piece, so they are sturdy long lasting.

4 Heavy-Duty Plastic BATTERA Mold

一体型ハツテラ型

- | | Rice weight (g) | finished Size (mm) | |
|----------------|-----------------|--------------------|--------------|
| ● Kanto syle : | 210 | 145×54×H50 | 31-0045-0401 |

5 Heavy-Duty Plastic SUZUME Mold

一体型すずめ

- 31-0045-0501
- Rice weight : 250 g
finished Size (mm) : 180×55×H50



6 Heavy-Duty Plastic TEMARI Sushi Mold

てまり寿司

- | | Rice weight (g) | finished Size (mm) | |
|----------------|-----------------|--------------------|--------------|
| ● L Makes 10 : | 25 | φ37 | 31-0045-0601 |
| ● S Makes 10 : | 13 | φ30 | 31-0045-0602 |



The lower mold is concave.

7 Heavy-Duty Plastic MATSUMAE Mold

松前型

- 31-0045-0701
- Rice weight : 250 g
finished Size (mm) : 180×55×H50



8 Plastic ONIGIRI Mold

PP おにぎり押型

- Makes 2 : 31-0045-0801
- finished Size (mm) : 60×60×H30



9 Stainless Rice Mold

18-8 物相型

- | | finished Size (mm) | |
|--------------------------|--------------------|--------------|
| ● UME(Apricot Blossom) | : 83×80×H50 | 31-0045-0901 |
| ● SUEHIRO | : 107×55×H50 | 31-0045-0902 |
| ● HYOTAN(Gourd) | : 105×60×H50 | 31-0045-0903 |
| ● GINNAN(Ginkgo Nut) | : 94×50×H50 | 31-0045-0904 |
| ● SAKURA(Cherry Blossom) | : 82×79×H50 | 31-0045-0905 |
| ● MOMIJI(Maple) | : 82×60×H50 | 31-0045-0906 |

SUSHI CUTTER & UTENSILS

Sushi is a combination of vinegared rice and usually seafood that is well known around the world. Types of sushi include the well-known nigirizushi (edomae), as well as makizushi, inarizushi, chirashizushi, oshizushi and many other variations. In addition, new styles of sushi such as the globally popular sushi trains and California rolls have also become staples.



Easily cut small, medium, and large sushi rolls, and even uramaki!

- Non Electric
- Easy to Operate and Clean
- please choose from the following cutting units
4, 6, or 8 piece vertical rolls, or 10 piece horizontal rolls

Even more efficient!



Improve productivity by cutting 2 medium rolls or 3 small rolls simultaneously!
Cut 1 roll per 5 seconds, or 700 rolls per hour.

A single flexible unit!



Simply change the cassettes to alter the cutting width.

Cassette storage system



Hygienic, safe, and convenient cassette storage. Use your kitchen more efficiently whether you are using the 6 piece cassette or the 8 piece cassette.

1 Non-Electric Makisushi Cutter

手動卓上巻ずしカッター

- 31-0046-0101

Size (mm) : W360×D410×H580
Weight : Body 13 kg Cassettes 3 kg



2 SUSHI OKE (Wooden Rice Mixing Tub)

飯台(すし桶) さわら材(銅タガ)

	ID×H (mm)	Capacity	
● 39cm	365×80	1.8 ㍓(1 sho)	31-0046-0201
● 45cm	425×90	3.6 ㍓(2 sho)	31-0046-0202
● 54cm	510×120	5.4 ㍓(3 sho)	31-0046-0203
● 60cm	560×120	7.2 ㍓(4 sho)	31-0046-0204
● 66cm	615×120	9.0 ㍓(5 sho)	31-0046-0205
● 72cm	680×140	10.8 ㍓(6 sho)	31-0046-0206

※ As this item is handmade, dimensions may differ slightly from the description.

Sushi Oke is a wooden bowl, traditionally used during the sushi rice making process. The wooden material absorbs excess moisture, while rice is being seasoned. Our SUSHI OKE are made with high quality Japanese Sawara Cypress wood, copper bands secured to add extra strength to hold the SUSHI OKE together, and an additional bamboo support that circles the bottom of the SUSHI OKE.



3 EDO-BITSU (Wooden Rice Jar)

江戸びつ(かぶせびつ) さわら材

- 21cm : 31-0046-0301

Size (mm) : φ182×H120
Capacity : 0.9 ㍓(0.5 sho)

※ As this item is handmade, dimensions may differ slightly from the description.



4 Polyethylene NUKI-ITA

抗菌 木芯入り 抜き板 C型(ポリエチレン製)

- L : 31-0046-0401

Size (mm) : W420×D210×H60



5 Polyethylene NUKI-ITA with Legs

抗菌 木芯入り 抜き板 足付き(ポリエチレン製)

- L : 31-0046-0501

Size (mm) : W420×D300×H60

Magic Rice Spatula Series

- We added fluoroc resin to polypropylene to create products with exceptional non-stick capabilities.
- Compliant with the Food Sanitation Act Examination



6 Magic Rice Spatula

抗菌 しゃもじ業務用(溝付)

	W×L (mm)	
● 23cm	85×230	31-0046-0601
● 43cm	135×430	31-0046-0602

Material : Polypropylene, antibacterial fluoroc resin (inorganic system)

Heat resistant up to : 120°C



7 Magic Rice Spatula

抗菌 しゃもじ(溝付)

- L : 31-0046-0701

Size (mm) : W67×L205
Material : Polypropylene, antibacterial fluoroc resin (inorganic system)

Heat resistant up to : 120°C



1 Copper Egg Pan

銅玉子焼 関東型

WxDxH (mm)

- 18cm : 180×180×33 31-0047-0101
- 21cm : 210×210×36 31-0047-0102
- 24cm : 240×240×39 31-0047-0103

It is difficult to make tamagoyaki (Japanese rolled eggs) in a round frypan, and a special square pan is usually used. Furthermore, in order to achieve exquisitely cooked eggs, restaurants use copper pans for their good heat conductivity.



2 Wooden Lid for Egg Pan

玉子焼用木蓋

LxW (mm)

- 18cm : 180×180 31-0047-0201
- 21cm : 210×210 31-0047-0202
- 24cm : 240×240 31-0047-0203



3 Aluminium Egg Pan

アルミ 玉子焼(大)

- 31-0047-0301

Size (mm) : W200×D210×H35
Thickness 4.0mm
Interior - fluoride resin coating
Material : Cast Aluminium

· The convenient shape and fluoride coating make it easy create Japanese style tamagoyaki at home.

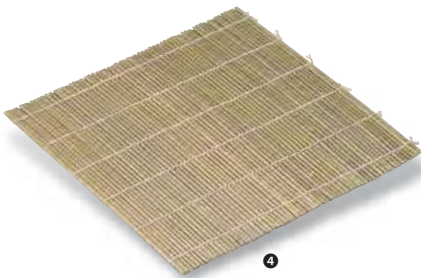

4 Makisu Bamboo Sushi Mat

巻寿司

LxW (mm)

- 24cm : 240×240 31-0047-0401
- 27cm : 270×270 31-0047-0402

Classic sushi mats for rolling up makizushi



5 Makisu Polypropylene Sushi Mat

PP巻寿司

LxW (mm)

- L : 305×250 31-0047-0501
- M : 240×250 31-0047-0502

- The threads are made from PET monofilaments. As there are no knots, this product dries quickly, and can be used immediately after disinfecting with hot water.
- Embossing on one side prevents rice from sticking.
- Unlike solid plastic sushi mats, highly rigid thin strips that mimic bamboo have been individually crafted, creating a supple yet sturdy feel when rolling foods such as sushi rolls and dashimaki tamago.



Anti Bacterial



6 Electric Seaweed Nori Drier

のり乾燥器 電気式

- 31-0047-0601

Size (mm) : W235×D145×H140
Electricity consumption : 100 V 14 W
type : Small base 110 V 15 W
Cord length : 1.9 m with in-line switch

Nori gradually turns purple, and loses crispness, fragrance, and flavor when exposed to humidity. By using this dehumidifier, you can limit the amount of humidity that your nori is exposed to.



7 Stainless Seaweed Nori Box

18-0 のり缶

WxDxH (mm)

- XL(20 Sheets Type) : 227×227×186 31-0047-0701
- L (10 Sheets Type) : 227×137×102 31-0047-0702



1 Stainless Boiled Egg Cutter
18-0 ピアノ線玉子切
● 31-0048-0101
Size (mm) : L135×W84
Easily slice boiled eggs for use in salads etc.



2 Boiled Egg Cutter
PC ピアノ線玉子切
● 31-0048-0201
Size (mm) : L113×W83
Easily slice boiled eggs for use in salads etc.



3 Quail Egg Cutter
ウスラカットブッチ
● 31-0048-0301
Size (mm) : 135



4 Stainless Yolk Separator
18-0 黄味取り器
● 31-0048-0401
Size (mm) : φ94×136



5 Plastic Scaler
ウロコトレーラー
● 31-0048-0501
Size (mm) : W90×D50×H50
Equipped with a handle to allow you to scale fish from directly above and prevent scales from scattering.



6 Brass Scaler
真鍮 ウロコ取
L (mm)
● XL : 210 31-0048-0601
● L : 180 31-0048-0602
Brass Scaler to remove small scales from delicate fish without damaging the flesh.



7 Round Fish Bone Tweezer
ステン骨抜 東型(丸)
● 31-0048-0701
Size (mm) : 120
Our round-tipped tweezers are popular among chefs and home cooks alike. Comfortable in the hand, and made of high quality stainless steel for removing all types of fish bones.



8 Square Fish Bone Tweezer
ステン骨抜 西型(角)
● 31-0048-0801
Size (mm) : 120
Large square fish bone tweezers with a broad tip are perfect for extracting stubborn or deep fish bones.

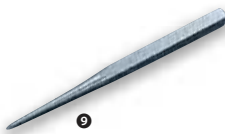

9 Stainless Spike for Eel
18-8 目打ち
● 31-0048-0901
Size (mm) : 145
Use these picks to pin eels to the chopping board by the head when filleting them.

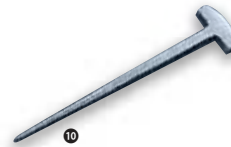

10 Stainless Spike for Eel T shape
18-8 T型 目打ち
● 31-0048-1001
Size (mm) : 145

Use these shuckers to remove or break the shells of bivalves. There are specialist shuckers for oysters, clams, and goducks etc.



11 Stainless Oyster Knife
ステン オイスターナイフ
L (mm)
● L : 210 31-0048-1101
● S : 150 31-0048-1102



12 Stainless Convenient Clam Knife
18-0 便利貝ムキ
● 31-0048-1201
Size (mm) : 130



13 Stainless Clam Knife
ステン ハマムキ
● 31-0048-1301
Size (mm) : 190



14 Stainless Mirugai (trough shell) Clam Knife
ステン ミル貝ムキ
● 31-0048-1401
Size (mm) : 220

SLICER

Our cooking equipment consists of small appliances that quickly and conveniently prepare food, such as by slicing, julienning, and grating vegetables etc. When cooking large quantities at a busy restaurant, even part-time employees can cut food evenly, and reduce costs. Both electric and manual models are available.



Easy to operate and exchange discs



SS-250C
Insertion slot

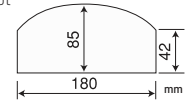

1 Mini Slicer SS-250C

ミニスライサー SS-250C

• 31-0049-0101

Size (mm) : W320×D270×H505
Weight : 7.5 kg
Power source : 220 V
Rated power consumption : 70 / 80 W
Slicing disc : (2 blades, 0.8 mm thick)
equipped as standard
Rated time : Continuous
Processing capacity : Approximately 1.5 kg of
cabbage per minute (0.8 mm thickness)

By exchanging the optional discs, you can slice, julienne, and grate food with this versatile appliance. As well as slicing cabbage, carrots, cucumbers, and lemons for salads, you can also grate daikon radish etc.



Light and compact



2 Julienne Disk

SS-250C用 千切り円盤

• SS-C3B : 31-0049-0201

Slice thickness (mm) : 2.0×4.0
Julienne carrots, daikon and cucumbers etc. for salads.



3 Radish Grate Disk

SS-250C用 おろし円盤

• SS-D1B : 31-0049-0301

Grate daikon radish and carrots etc.

Soft strips of cabbage served at breaded pork cutlet restaurants are made in just about no time!



planetary motion system of round blade

4 Multi Slicer DX-100

マルチスライサー DX-100

• 31-0049-0401

Size (mm) : W340×D430×H510
Weight : 10 kg
Power source : 220 V
Insertion slot : $\phi 70$, $\phi 200$ (Deformed semicircular)
Rated power consumption : 180 / 220 W
Operating time : 30 minutes
Processing capacity : Cutting four cabbages into thin strips : 3 minutes and 20 seconds (1 mm in width)
Adjustment of thickness : 0.3 to 5.0 mm
(Stepless adjustment by the three screws of the turntable)

- By the ultra-high speed planetary motion of round (PAT.) blades (2150 rpm), amazingly speedy processing is achieved
- Even soft spring cabbages and lettuces are easily cut
- Easy cleaning and maintenance by the simple structure.



Simply cut the cabbage in half and charge! Thin strips of cabbage are made automatically.



planetary motion system of round blade

5 CABEROBO DX-150

キャベロボ DX-150

• 31-0049-0501

Size (mm) : W393×D408×H486
Weight : 15 kg
Power source : 220V
Insertion slot : $\phi 280$ H170
Rated power consumption : 180 / 220 W
Operating time : 30 minutes
Processing capacity : Cutting four cabbages into thin strips : 5 minutes (1 mm in width)
Adjustment of thickness : 0.3 to 4.0 mm (Stepless)

- From the planetary motion system of round blades, (PAT.) cabbages can be sliced cleanly and evenly with no difficulty.
- Soft strips of cabbages with a nice texture are made in just about no time.



6 Non-Electric Cabbage Slicer CABBAGE-KUN

キャベツくん(手動)

• 31-0049-0601

Size (mm) : W240×D220×H300
Weight : 1.8 kg
Thickness : Adjustable from 0 to 2.5mm
Processing capacity : Whole cabbage / 2 minutes.

(Method of Operation)

Slightly cut the cabbage heads with a knife, insert the center shaft into the core of the cabbage, set it into the machine, and turn the handle while lightly pressing on the top to cut the cabbage.



This strips of cabbages

Example: Cutting cabbages into thin strips
Work efficiency
In manual terms:
Around 12 times

This machine is completely suited to cutting leeks into round slices!



planetary motion system of round blade



1 Multi Slicer Mini DX-50
マルチスライサー ミニ DX-50

● 31-0050-0101

Size (mm) : W220×D340×H370
Weight : 5 kg
Power source : 220 V
Insertion slot : 95×38
Rated power consumption : 100 / 110 W
Adjustment of thickness : 0.3 to 5.0 mm
Operating time : 20 minutes
Processing capacity : Cutting 15 long green onions(around 3kg) into round slices : about 1 minute

- By the ultra-high speed planetary motion of round blade(6000 rpm), amazingly speedy processing is achieved.
- Easy cleaning and maintenance from the compact design.



Leeks

Ideal for slicing whole green onions

Includes conveyor belt



2 Non-Electric Negi(Green Onion) Slicer NEGI-MARU 120

手動ネギ丸 120

● 31-0050-0201

Size (mm) : W380×D240×H360
Weight : 4 kg
Insertion slot : 40 × 60
Available thicknesses : 1 mm, 2 mm, 3 mm
Blade type : Circular blade

- Includes circular blade sharpener
- The high rotating roundblade catches the green onions so it can cut it without crushing it. It also works well for chives, and leeks, as well as large green onions. Since it is a manual machine you can wash the whole machine.
- You can use the feeding mechanism to select the thickness.
- You can cut diagonally (substitution for shredded spring onion), which is excellent for spring onion ramen, by removing the front cover and exchanging the blade.

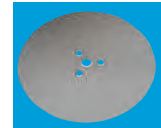

[Core type] 3mm How to make shredded green onion



3 Non-Electric Negi(Green Onion) Cutter SHIRAGA 2000

手動 SHIRAGA2000(芯ありタイプ)

● 31-0050-0301
Size (mm) : W195×D240×H285
Weight : 2.0 kg
Process ability : 3 kg / 10 minutes
Insertion slot : φ30
Size of the green onion : 3 mm

This product is a manual green onion cutter that can make shredded onion similar to that achieved by hand cutting. You can easily shred large green onions just by inserting the green onion, pushing it in with an attached push stick and spinning the handle. It is very easy to clean! It is much smaller and lighter than other models, so daily cleaning is much easier.



5 Vegetable Julienne Machine DX-80

マルチ千切り DX-80

● 31-0050-0501
Size (mm) : W380×D230×H380
Weight : 7.8 kg
Power source : 220 V
Power consumption : 100 W
Insertion slot : 80×80×H70
Operating time : 30 minutes
Processing capacity : 10 minutes / 10 kg
Accessories : Julienne disk (3.0 mm×3.0 mm), perfect sized cutting board
Cutting into thin strips and rectangles and slicing.



4 Radish and Tororo (Yam) GRATER M-2D

トロロ・オロシー M-2D

● 31-0050-0401

Size (mm) : W160×D260×H300
Insertion slot (mm) : φ100
Weight : 4 kg
Power source : 100V 50 / 60 Hz
Rated power consumption : 150 / 170 W
Operating time : 15 minutes
Process ability : 1 kg / minutes

- Uses a specially designed grater. Perfect for making tororo (grated mountain potato).
- Grates mountain potatoes, daikon, and carrots as though grated by hand.





"Peel S" has a great reputation for cutting "Katsuramuki". When you rotate the handle, the blade will slide left and right, which makes it shining like if you used a knife.



1 Radish Turning Katsuramuki PEEL-S
かつらむきピールS

● 31-0051-0101

Unit Size (mm) : W300×D240×H165
Weight : 1.7 kg
Maximum diameter : 100mm
Maximum width : 120mm
Thickness of Katsuramuki : about 0.5 mm (without thickness adjustment sheet.)
Thickness of adjustment sheet : 0.3 mm (you can use up to 2sheets.)
Garnish size : about 0.8 mm

2 Tsumakiri(Sherredding) Garnish Cutting Adaptor Set for PEEL-S

ピールS用ツマ切アダプターセット(クシ刃0.8mm)

● 31-0051-0201

・ Used for making shredded daikon (tsuma).

*You cannot cut garnish with katsuramuki machine.
If you want to cut garnish, you have to purchase garnish cutting adaptor set and exchange the parts.

Even though it is smaller than "Peel S" the unique blade sliding mechanism similar to Peel S will provide the sharpness close to the hand cutting. Also, the standard machine can cut katsuramuki and garnish. The blade parts are easily changeable.



3 Radish Turning Katsuramuki & Garnish Cutter NII TSUMASAN
新つまさん(かつらむき&つまきり)

● 31-0051-0301

Unit Size (mm) : W260×D240×H165
Weight : 1.0 kg
Maximum diameter : 100mm
Maximum width : 80mm
Garnish size : 0.8 mm

Thickness of the rotary peel :
① 0.8 mm . ② 1.0 mm . ③ 1.2 mm . ④ 1.4 mm

By changing the space from the flat blade by adjusting the top lid of the rotary peel bench left and right, you can adjust the thickness in 4 levels. (You can use up to 2 thickness adjustment sheets.)

Uses a special stainless steel blade

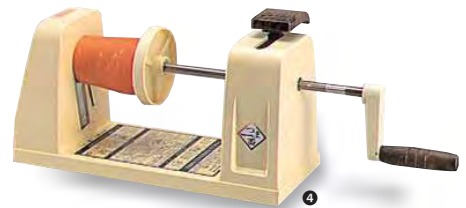

4 Radish Garnish Cutter TSUMA-ICHIBAN HS-313

プラスチックつま一番 HS-313

● 31-0051-0401

Size (mm) : W410×D130×H180
Equipped comb blade : 1.0mm

・ This device is fed by a screw, so there is no need to feed in the vegetables. All you need to do is turn the handle.

Easy to handle, so that even part-time employees can use it in many stores. Its compact size means that it does not take up storage space, and cleaning up is easy after use.

As well as "Katsuramuki" and garnish cutting, it can also cut web cutting(2 types; nageami and odoriامي). When you rotate the handle, the blade will slide left and right, which makes the beautiful shine just like peeling with a knife. it will make your food presentation beautiful.

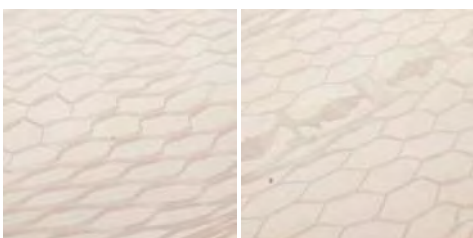

(Nageami)

(Odoriامي)



5 Radish Turning Katsuramuki & Garnish Cutter & Web Cutter TSUMA-TARO

つま太郎

● 31-0051-0501

Unit Size (mm) : W300×D250×H170
Weight : 1.9 kg
Maximum diameter : 100mm
Maximum width : 120mm

Thickness of the rotary peel : about 0.5 mm (without thickness adjustment sheet.)
Garnish size : about 0.8 mm
Thickness of adjustment sheet : 0.3 mm (you can use up to 2sheets.)

BENRINER

Benriners are one of the most popular Japanese slicers. These hand-operated machines make vegetable preparation a snap. Useful in both Japanese and Western kitchens. No kitchen should be without this affordable and easy to use tool. This product features an adjustable blade for slices of varying thickness. Replacement blades are available

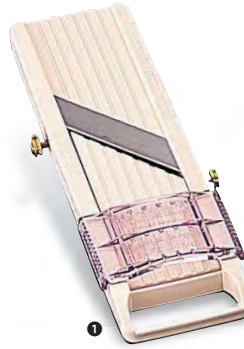

1 Vegetable Garnish Cutter & Slicer BENRINER

ベンリナー

● 31-0052-0101

Size (mm) : D320×W100×H24

・ Adjustable thickness (0.3~5 mm).

・ Comes with flat blade and comb blades (fine, medium, and rough).

・ Comes with a safety device to protect your fingertips.

・ Use this one tool for all vegetable preparation.



2 Vegetable Slicer JAMBO BENRINER

ジャンボベンリナー(スライス専用)

● 31-0052-0201

Size (mm) : D305×W144×H24

・ Adjustable thickness (0.5~8 mm).

※ Comb blades cannot be attached.

・ Slice large vegetables with ease



3 Comb blades for BENRINER

ベンリナー クシ刃

(mm)

● Fine : 1.5 31-0052-0301

● Medium : 3.0 31-0052-0302

● Rough : 11 31-0052-0303

※ This Comb blades cannot be fitted with JAMBO BENRINER.



4 Vegetable Garnish Cutter & Slicer SENGIRI-SLICE-KUN

せんぎりスライスくん(業務用)

● 31-0052-0401

Size (mm) : D350×W145×H28

Material : Body - ABS resin (heat resistant to 80°C)

Maximum slice width : 118mm

Julienne width : Fine comb blade (1 mm), medium (2.5 mm), Rough (8 mm)

・ Slice and julienne vegetables with a single tool .

・ Slice thickness is easily adjustable with the turn of a dial.(0.5~3.5 mm)

・ Comes with protective holder



・ Remove the pineapple from the slicer and then lower the wedger to cut bite-sized portions.



・ The handle is removable with the touch of a button, which is convenient for removing pineapple slices or washing the slicer.

5 Pineapple Slicer & Wedger

パキュバン パイナップルスライサー&ウェッジャー

● 31-0052-0501

Size (mm) : φ130×H225

Material : ABS resin

・ Comes with a wedger to cut into bite-sized portions.

・ Remove the handle with the press of a button.



6 Vegetable Slicer SLICE-KUN

手動スライサー「スライスくん」

● 31-0052-0601

Size (mm) : W415×D170×H170

Weight : 1.6 kg

Insertion slot : 90 × 90 (adjustable through the separator)

Adjustable thickness : Slicing thickness - 0.5~10 mm, julienne width : 3 mm

・ Exceptional cutting edge produced by the use of a unique V-cutter.

・ By using the attached julienne blade (approximately 3 mm), you can produce slices and strips as desired.



7 Apple Peeler

ナイフン(PC)

● 31-0052-0701

Size (mm) : W210×D125×H150

・ A peeler for round fruits of about φ55~φ115mm such as apples and nashi-pears.



1 Non-Electric Mincer No.5(β)

ミンサーNo.5(β型) (ねじ止め式)

● 31-0053-0101

Size (mm) : W180×D70×H270
 Weight : 2.5 kg
 Capacity : 12 kg / h
 Input aperture size : 73×72
 Output diameter : φ53
 Standard equipment : 3.2 mm plate

This device can be used for diverse applications, ranging from mincing meat, fish, shellfish, shrimp, and squid, to grinding beans for miso. Grind meat or miso with ease. There are many plate sizes available, so choose the correct size for your needs.

■ Plate holes and applications

Hole sizes	1.6mm	3.2mm	4.8mm	6.4mm
Minced meat		◎	○	
Minced fish		◎	○	
Fish paste	◎			
Fish food			○	○
Croquets/potatoes		○	○	◎
Miso beans		◎	○	○
Squid/octopus		◎	○	
Red bean paste	◎			

2 Plate for Mincer No.5(β)

ミンサー用プレート

- φ1.6 mm : 31-0053-0201
- φ3.2 mm : 31-0053-0202
- φ4.8 mm : 31-0053-0203
- φ6.4 mm : 31-0053-0204

Smoke Wood Sticks are an easy way to impart smoky flavors to your favorite ingredients. Cut off as much as you need, then light one end for it to burn for up to 4 to 5 hours.

● Cherry

This is the most common and fragrant wood, and it is best suited for strongly flavored meats such as mutton and lamb.

● Walnut

This wood does not have a strong scent, and is suited for a broad range of meat and fish.

● Apple

This wood has a delicate fragrance, and is best suited for milder ingredients such as chicken and white-fleshed fish.

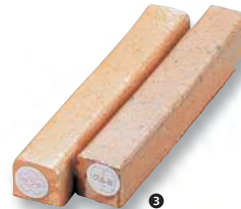

3 Smoke wood Stick

スモーク用ウッド ロング

D×H×W (mm)

- Cherry : 50×50×300 31-0053-0301
- Walnut : 50×50×300 31-0053-0302
- Apple : 50×50×300 31-0053-0303

Smoking time : Approximately 4~5 hours

This product is frequently used by stores in Japan that produce yakitori, kabayaki, or yakiniku, and prefer cooking over charcoal.



4 Charcoal Starter Pan with Handle

木柄 鉄ジャンボ火起し(鉄目皿付)

(mm) L (mm)

- L : φ240 460 31-0053-0401

・ This tool is designed for lighting charcoal.



5 Charcoal Starter Stove

火種コンロ

● 31-0053-0501

Size (mm) : OD φ320×H400 ID φ220×H165

※ Do not use a blower to send air through the air intake.

- ・ Store charcoal so that it can be used straight away.
- ・ Control the coals by adjusting the lid and the air intake.
- ・ You can easily light new charcoal by adding it on top of existing coals.
- ・ With excellent moisture retention, you can extend usage times.



6 Fire Extinguish Pot

大型火消しつぼ

● 31-0053-0601

Size (mm) : OD φ320×H360 ID φ210×H220
 Weight : 11 kg

- ・ Extinguish flame without using water. Extinguished charcoal is reusable, making this extremely economical.
- ・ Fire resistant, with excellent insulation.



7 Cast-Iron Fire Extinguish Pot

鉄鑄物 火消し壺

ID×H (mm)

- XL : φ260×205 31-0053-0701

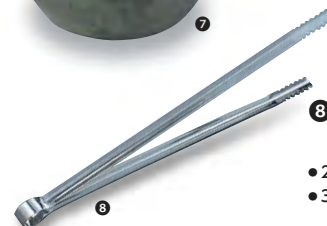

8 Charcoal Tongs

18-0 炭バサミ(板厚0.7mm)

- 24cm : 31-0053-0801
- 30cm : 31-0053-0802

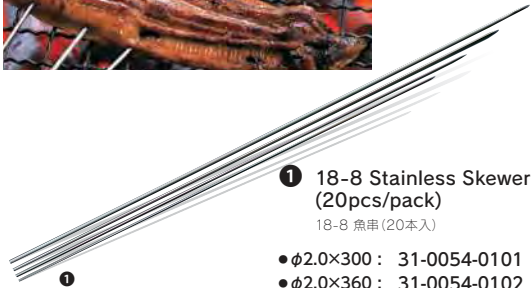
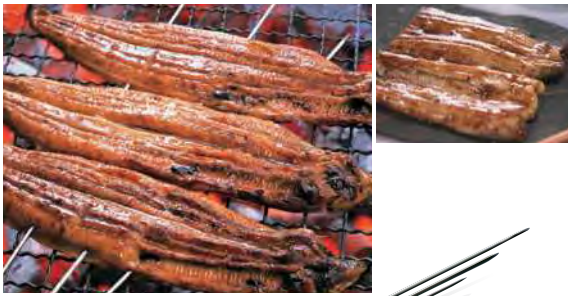

1 18-8 Stainless Skewer (20pcs/pack)
18-8 魚串 (20本入)

- $\phi 2.0 \times 300$: 31-0054-0101
- $\phi 2.0 \times 360$: 31-0054-0102
- $\phi 2.0 \times 390$: 31-0054-0103
- $\phi 2.0 \times 420$: 31-0054-0104
- $\phi 2.0 \times 480$: 31-0054-0105



2 Commercial Sauce Pourer for Eel Dishes
うなぎタレ掛 本職用

- 31-0054-0201

Size (mm) : 250

It can be used to pour the tare sauce on the broiled eel.



3 Earthen Pot
陶器製 半網かめ (蓋付)

- No.3 : 31-0054-0301

Size (mm) : $\phi 225 \times H255$

Capacity : 5.40ℓ

This is an old-style tokoname-yaki jar. It will not corrode due to salinity, so it can be used for many purposes, from making pickles, such as umeboshi, to making miso, or even holding sauces.



5 Chromium-plated Iron Net with Handle
合せアミ (鉄・クロームメッキ) シングル取手35号

- 31-0054-0501

Size (mm) : D350×W300

Handle length : 200 mm

Material : Iron · Chromium plating

· $\phi 1.5$ crimp, 18.5 mm holes



4 Chromium-plated Iron Net
業務用焼網・ストロング (鉄・クロームメッキ)

- D×W (mm)
- # 27 : 270×240 31-0054-0401
 - # 36 : 360×330 31-0054-0402
 - # 60 : 600×400 31-0054-0403

Material : Iron · Chromium plating

· $\phi 2.5$ crimp, 13 mm holes

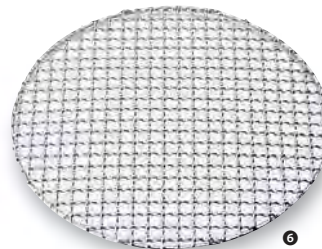

6 18-8 Stainless Round Net TAFUMARU

18-8 クリンプ目丸焼網・タフマル

- 24cm : 31-0054-0601

Size (mm) : $\phi 240$

· $\phi 2.5$ crimp, 10 mm holes



Properties of TAFUMARU

- This product is created by applying wave-like bends to the wires, so that they interlock, and are therefore extremely durable, and maintain their shape.
- The joints between the outer frame and the inner wires are rounded in the interest of safety.



7 Ceramic Fish Grill Pan with Handle
セラミック魚焼 (大)

- 31-0054-0701

Size (mm) : D205×W250×H40 · (L381)

Weight : 500 g

- The upper mesh can be easily unclipped and removed.
- The lower mesh includes ceramic to impart an authentic charcoal flavor. It can also be washed in water.



1 Electric Thermal Rice Container 1575XB

電子保温コンテナ 1575XB

● 31-0055-0101

Size (mm) : 483×373×H256
 Material : Polypropylene Weight : Approximately 3.4 kg
 Capacity : 20ℓ (9ℓ (5 sho), or
 300 formed logs (sharidama) of sushi rice)
 Selectable temperatures : 15 ~ 74 °C (dial type)

- Detachable cord. The connector plug comes with a cap to protect against water.
- Whether storing rice for sushi, or keeping it warm, or storing lunch boxes, stew or soup, you can maintain the desired temperature simply by turning the dial.
- Thoroughly washable with a water resistant design.
- Made from hygienic polypropylene



2 Electric Thermal Sushi Rice Jar EVER-HOT NS-21E

エバーホット匠NS-21E(江戸蓋タイプ)

● 31-0055-0201

Size (mm) : φ240×H162
 Material : Body - cypress / hoop - copper
 Weight : Approximately 1.7 kg
 Capacity : 900 ml (5 go)
 Power supply : Single phase 100 V 50 / 60 Hz
 Power consumption : 50 W
 Temperature : Approximately 36 ~ 42 °C
 Maximum duration of use : Approximately 60 minutes

- Expressing the preferences of sushi chefs through the combination of Kiso's traditional craftsmanship with electronics.
- Ideal for use in places that are visible from where guests are seated.



3 Stainless Thermal Jar KJ-600

18-8 ステンレスジャー

● 31-0055-0301

Size (mm) : 455×365×H290
 Insulated container : 6ℓ (3 sho)
 Temperature : 77 °C and above
 Maximum duration of use : Approximately 6 hours

- Join free construction means the whole item can be washed.
- Thermal insulation makes this product ideal for maintaining either hot or cold temperatures. An extremely absorbent condensation collector is installed under the lid, which prevents rice from becoming sticky.
- Stackable



4 Plastic Thermal Rice Pot DF-R1

プラスチック保温食缶 ごはん用

● 31-0055-0401

Size (mm) : 380×324×H312
 4.5ℓ (2.5 sho)
 Thermal insulation capacity : 5 hours, approximately 68 °C / 10 hours, approximately 53 °C (at room temperature of 24 °C, containing 5.2ℓ at a starting temperature of 95 °C)
 Material : Body/lid - polypropylene, absorbent sheet - cellulose

- Do not use in dry storage unit.

SUSHI RICE WARMERS

The Ever Hot Sushi rice warmers are top of the line, reliable, high quality rice warmers that are great for any sushi restaurant. It is crucial to keep sushi rice at body temperature. The Ever Hot rice warmer comes with a rice net and a wooden frame that holds the rice as it bathes in water to keep it at the perfect temperature.

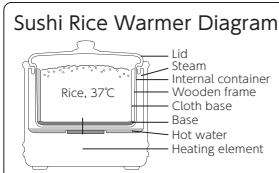

5 Electric Thermal Sushi Rice Jar EVER-HOT NV-35P

エバーホット湯煎式電気びつ NV-35P(すし用)

● 31-0055-0501

Size (mm) : φ415×H401
 Insulated container: Approximately 6.3ℓ (3.5 sho)
 Power consumption : 100 V 50 W Temperature : 37 °C (for sushi)
 Internal pot : Stainless steel



6 Electric Thermal Sushi Rice Jar EVER HOT NV-25

エバーホット湯煎式電気びつ(木目)NV-25(すし用)

● 31-0055-0601

Size (mm) : φ385×H410
 Insulated container : Approximately 4.5ℓ (2.5 sho)
 Power consumption : 100 V 47 W Temperature : 37 °C (for sushi)
 Internal pot : Aluminum



1 KYS Rice Cooking Net (Bag Type)

KYS 業務用 炊飯用袋ネット

Diameter×H (mm)

- L 9ℓ (5 sho) : Base diameter 420 (top diameter 470) × 400 31-0056-0101

Material : Polyester
Heat resistant to : 240°C

· This net can be used for the whole rice cooking process, from washing to completion.

KYS Rice Cooking Net (Bag Type)

Use this net when washing rice to remove impurities, broken grains, and stunted grains, before transferring the net to the rice cooker and taking it out when the rice is cooked. This is an economical and logical way to cook delicious rice, easily and without fuss.

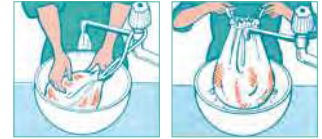

1. Wash the rice



2. Drain the water



3. Cook the rice as it is



4. Transfer it to the rice warmer

★ Please wash the pot and the net after each use.

· (Caution) do not expose directly to flame.



2 KYS Rice Cooking Net

KYS 炊飯平ネット

W×D (cm)

- L : 100×100 9ℓ (5 sho) 31-0056-0201

Material : Polypropylene 100%
Heat resistant to : 200°C

The rice cooking net is a reusable net that prevents rice from sticking to the bottom of the rice cooker.

Prevents burning and boiling over, and "can be used anywhere"

When keeping soups warm, the most important element to consider is changes in flavor due to burning and boiling over. For this reason, the soft heat imparted by hot water or steam is preferable to the hard heat from a gas flame. By using this soft heat, we prevent boiling over and burning, while maintaining the flavor of the soup. The Soup Warmer Everhot gently warms soup using soft heat.



Soup Warmer Diagram

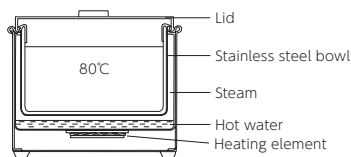

3 Electric Soup Warmer EVER-HOT NL-16P

エバーホット湯煎式スープウォーマー (80°C固定)

- 31-0056-0301

Size (mm) : φ415×H359
Weight : 9.5 kg
Capacity : 16ℓ
Power source : Single phase 100 V 50 / 60 Hz
Power Consumption : 230 W
Temperature setting : Fixed at approximately 80°C
Body : Steel sheet
Material : Internal pot / external pot - stainless steel



4 Plastic Thermal Miso Soup Pot DF-M1

プラスチック保温食缶 みそ汁用

- 31-0056-0401

Size(mm) : 386×324×H312
Capacity : 13ℓ
Color : Dark brown
Thermal insulation capacity : 5 hours, approximately 68°C
10 hours, approximately 53°C



5 Electric Oden Warmer CVS-6S

電気おでん鍋 CVS-6S

Size (mm) : 370×470×H279 Pot 275×369×H125
Power supply (Single phase 100 V) : 0.75 kW
Weight : 12 kg



Oden is a type of Japanese stew, which uses a broth of dashi and other seasonings such as soy sauce to flavour various ingredients, such as daikon, chikuwa (fish cake), konnyaku and boiled eggs. Flavorings vary from region to region. Oden is often found in convenience stores as fast food, which is rare for a stew. It is also sold in Taiwan, where it is given the Osaka name of "kanto-ni".



1 Sake Warmer Dispenser Ti-1

タイジ 卓上型全自動酒燗器Ti-1

● 31-0057-0101

Size (mm) : W160×D345×H483.5
 Weight : 5.8 kg Water tank capacity : 2.3ℓ
 Power source : 220~240 V
 Temperature adjustment : Adjustable thermostat
 Heating method : Indirect heating
 Sake capacity : 1 x 1.8ℓ (1 sho) bottle
 Sake outputs : 1 Safety mechanisms : In-line fuse
 Sake dispensing method : Auto-stop method (liquid level sensor)
 Accessories : Copper × 1, Sake bottle stand × 1, Water funnel × 1,
 Anti-tip mechanisms fitted



2 Sake Warmer Dispenser Ti-2

タイジ 卓上型全自動酒燗器Ti-2

● 31-0057-0201

Size (mm) : W160×D345×H625
 Weight : 6.7 kg Water tank capacity : 2.3ℓ
 Power source : 220~240 V
 Temperature adjustment : Adjustable thermostat
 Heating method : Indirect heating
 Sake capacity : 3.6ℓ
 Sake outputs : 1 Safety mechanisms : In-line fuse
 Sake dispensing method : Auto-stop method (liquid level sensor)
 Accessories : Air supply pipe cleaning brush × 1,
 Filter (spare) × 1, Sake bottle stand × 1, Water funnel × 1
 Anti-tip mechanisms fitted



(Comes with lid)
 ・ Sake bottle capacity
 Approximately 12 180 ml (1 go) bottles or 8 360 ml (2 go) bottles

3 Kan Doko Sake Warmer HS-8N

タイジ 燗どうこ HS-8N

● 31-0057-0301

Size (mm) : W251×D196×H253 ID 249×194×H170
 Weight : 3 kg
 Power source : 220~240 V
 Temperature adjustment : Adjustable thermostat (30°C ~ 90°C)
 Accessories : Drain board × 1, bottle cap × 1, lid × 1,
 warmed sake meter × 1



4 Aluminium Sake Warming Pot

アルミ 燗タンポ

- | | φ×H (mm) | (cc) | |
|-----------|----------|------|--------------|
| ● No. 1 : | φ68×118 | 290 | 31-0057-0401 |
| ● No. 2 : | φ82×142 | 520 | 31-0057-0402 |

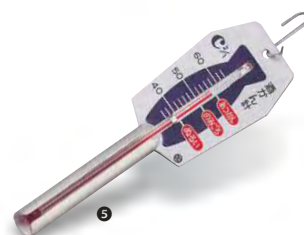

5 Okankei Sake Thermometer

お燗計

● 31-0057-0501

Size (mm) : 155
 Measurement range : 36 ~ 64°C
 Minimum scale value : 2°C



Sushi case

Sample of the OH Sushi case machinery cover colors and patterns

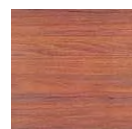

Wood



Black



Please allow space for air intake and exhaust.

※ Travels along the bottom of the case, eliminating condensation and expelling warm air.

Electric Sushi Case (Round Type)



Machinery Room:Left

① Electric Sushi Case(Round Type)

ネタケース OH丸型-Sa(スタンダードタイプ)

	Total width (mm)	Case width (mm)	Depth (mm)	Height (mm)	Compressor output (W)	Power consumption 50/60Hz (W)	Weight (kg)	Machinery Room Left	Machinery Room Right
OH Circular-Sa-1200	1,200	750	300	275	100	131/148	28	31-0058-0101	31-0058-0102
OH Circular-Sa-1500	1,500	1,050				134/151	32	31-0058-0103	31-0058-0104
OH Circular-Sa-1800	1,800	1,350				145/159	37	31-0058-0105	31-0058-0106
OH Circular-Sa-2100	2,100	1,650			125	158/183	41	31-0058-0107	31-0058-0108

Power source : Single phase 100 V 50 / 60 Hz Internal temperature : 5°C±3 Coolant : R-134a
 · Designed with safety in mind, with a short circuit prevention plug to prevent accidents and incidents.

※ Specify whether you would like the machinery to be housed on the left (L) or right (R) of the unit when viewed from the front.

※ Specify your preferred color and pattern of machinery cover when ordering (wood / black).

- Internal humidifier prevents fish from drying out. There is no need to wrap in plastic
- Balanced cooling, with no visible pipes to prevent ice build up
- Designed for long term dependability
- Durable energy-efficient construction, very quiet, and very low vibration

Electric Sushi Case (Square Type)

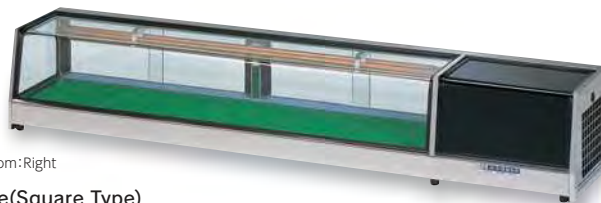

Machinery Room:Right

② Electric Sushi Case(Square Type)

ネタケース OH角型-Sa(スタンダードタイプ)

	Total width (mm)	Case width (mm)	Depth (mm)	Height (mm)	Compressor output (W)	Power consumption 50/60Hz (W)	Weight (kg)	Machinery Room Left	Machinery Room Right
OH Square-Sa-1200	1,200	750	300	275	100	131/148	28	31-0058-0201	31-0058-0202
OH Square-Sa-1500	1,500	1,050				134/151	32	31-0058-0203	31-0058-0204
OH Square-Sa-1800	1,800	1,350				145/159	37	31-0058-0205	31-0058-0206
OH Square-Sa-2100	2,100	1,650			125	158/183	41	31-0058-0207	31-0058-0208

Power source : Single phase 100 V 50 / 60 Hz Internal temperature : 5°C±3 Coolant : R-134a
 · Designed with safety in mind, with a short circuit prevention plug to prevent accidents and incidents.

※ Specify whether you would like the machinery to be housed on the left (L) or right (R) of the unit when viewed from the front.

※ Specify your preferred color and pattern of machinery cover when ordering (wood / black).

- Internal humidifier prevents fish from drying out. There is no need to wrap in plastic
- Balanced cooling, with no visible pipes to prevent ice build up
- Designed for long term dependability
- Durable energy-efficient construction, very quiet, and very low vibration

Hatsuyuki BLOCK ICE SHAVER

Enjoy 90%+ profit margin from only a small amount of space. Not only is each unit compact (size), but easily installed and very simple to operate.

Hatsuyuki's unique blade adjustment control gives you a choice in the ice texture. From coarse and grainy to light as fresh fallen snow. If you're looking for a cool item for hot profits, look at Hatsuyuki.

Ice lasts longer!!
Includes lift-up feature



What is the lift up feature?

Note
When ice is left sitting without shaving it, the lift-up feature helps it to last longer without melting

The photograph shows ice left for 4 hours at an indoor temperature of 24.5°C



Without the lift-up feature With the lift-up feature

Block ice shaver operating procedure

① Open the sliding cover and position the ice.

② Close the sliding cover, and select the appropriate coarseness.

③ Insert the container and turn on the switch.



The Hatsuyuki block ice shaver is fitted with a cover for your safety. Do not turn the machine on when the cover is open.

① Electric Block Ice Shaver HB-320A

初雪 電動式ブロックアイススライサー HB-320A

● 31-0059-0101

Size (mm) : 355×402×H565 (+195)

Weight : 20 kg Coarseness adjustment : Stepless

Power source : 230V 50 / 60 Hz

Standard rating capacity : 1.8 ~ 2.2 (kg / min)

Effective disc diameter : φ approximately 200 mm (Max height, 160 mm)

· The base disc and ice clamp are removable for easy cleaning.

· The energy efficient design saves power.

Block Ice Shaver (manual)
Perpetually best-selling manual device



Creates shaved ice that is soft like powder snow



② Non-Electric Block Ice Shaver HA-110S

初雪 手動式ブロックアイススライサーHA-110S

● 31-0059-0201

Size (mm) : 399×273×H612

Weight : 14.5 kg

Coarseness adjustment : Stepless

Standard rating capacity : 0.7 (kg / min)

Effective disc diameter : φ approximately 200 mm



Hatsuyuki CUBE ICE SHAVER

This ice shaver uses ice cubes of approximately 3 cm.
Easily put genuine shaved ice on your regular menu



① Electric Cube Ice Shaver HC-77A
初雪 電動式キューブアイススライサー HC-77A

- 31-0060-0101
- Size (mm) : 290×360×H499
- Weight : 17.5 kg
- Power source : 220 V 50 / 60 Hz
- Standard rating capacity : 2.5 / 3.0 (kg / min)
- Capacity : Approximately 70 ~ 77 ice cubes (3cm blocks)

Hatsuyuki CUBE ICE CRUSHER

Ice Crusher (manual)
Our most popular and convenient manual ice crusher.



② Non-Electric Ice Crusher HA-1700
初雪 手動式アイスクラッシャー HA-1700

- 31-0060-0201
- Size (mm) : 316×260×H317
- Weight : 5kg Coarseness : Approximately 12mm chunks
- Standard rating capacity : 0.6 (kg / min)

Hatsuyuki CUBE ICE CRUSHER & SHAVER

The crush and shaver combines
the features of an ice crusher and
shaved ice machine in a single unit.



③ Electric Ice Crusher & Shaver CS-S32A
初雪 電動式クラッシュ&スライサーCS-S32A

- 31-0060-0301
- Size (mm) : 306×421×H429
- Weight : 16 kg
- Power source : 220 V 50 / 60 Hz
- Standard rating capacity : Shaving 1.4 / 1.7 (kg / min)
- Crushing : 8.5 / 10.0(kg / min)
- (Crushing coarseness approximately 18mm chunks)
- Capacity : Approximately 35 ice cubes (3 cm blocks)

Ice cube shaver operating procedure

- ① Insert the ice and close the lid.
- ② After selecting the coarseness, insert the container and turn on the switch.



* Please use ice blocks of approximately 3 cm.

Dismantle to wash



The spinning blade is removal. Dismantling the device makes maintenance easy!!

Use a single lever to select between shaved ice and crushed ice



SHAVER

CRUSHER

Do not use the Hatsuyuki ice shaver or crusher with an electrical generator.

SHAVER



CRUSHER



The standard "Ice Flag" in Japan.



1 Ice Flag
氷旗

W×H (mm)
 ● M : 510×700 31-0061-0101
 ● S : 350×400 31-0061-0102
 Material : Cotton



2 Stainless Ice Scoop
18-8 アイススコップ

Size (mm)
 ● XL : A245×B160×C345 31-0061-0201
 ● L : A220×B135×C320 31-0061-0202

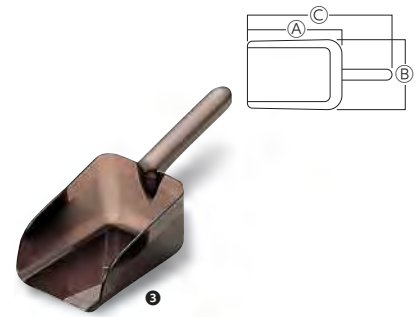

3 Polycarbonate Ice Scoop
ポリカーボネイトアイススコップ

Size (mm)
 ● M : A170×B126×C310 31-0061-0301



4 Stainless Ice Picker with Wooden Handle
アイスピック(大)

● L : 31-0061-0401
 Size (mm) : 230



5 Stainless Icecream Dish
18-8 デッシャー

φ (mm) (cc)
 ● #14 : 59 60 31-0061-0501
 ● #16 : 55 50 31-0061-0502
 ● #18 : 50 35 31-0061-0503



6 Stainless Grapefruit Squeezer
18-8 両口グレープフルーツ絞り

● 31-0061-0601
 Size (mm) : φ135×155×H60



7 Stainless Lemon Squeezer
18-8 両口レモン絞り

● 31-0061-0701
 Size (mm) : φ105×125×H43

This towel steamer warms moist hand towels to 70°C~80°C. Maintenance is easy, making this ideal for wiping hands and faces, or cleaning. Please use a heat resistant polyethylene bag for rolled towels to avoid discoloration and drying.



Stylish and Compact!
 May also be stood upright.

8 Towel Warmer HC-6
タイジ ミニキャビ HC-6(前開き)

● White : 31-0061-0801
 Power source 220~240 W
 Power consumption 120 W
 Temperature adjustment Bi-metallic thermostat
 Internal temperature Standard temperature 70~80°C
 Safety features Temperature fuse
 External dimensions 300×307×H230
 Internal dimensions 220×220×H135
 Capacity : 6ℓ (approximately 32 towels)
 Weight : 4 kg
 Accessories Rack × 1 Drainage tray × 1

High-class traditional Japanese ceramic finish



9 Stainless Vacuum Handy Jug [KOKUTOH]
卓上用ステンレスポット 黒陶

W×D×H (mm)
 ● THQ-1001(1.0ℓ) : 185×135×190 31-0061-0901
 ● THQ-1501(1.5ℓ) : 185×135×230 31-0061-0902

・ Wide 5.5 cm input aperture takes large ice pieces
 ・ Holds a coffee dripper.
 (Some drippers may not fit, depending on their shape.)



10 Stainless Tea Strainer with Wooden Handle
18-8 木柄深型茶こしダブル(16+40メッシュ)

● 31-0061-1001
 Size (mm) : φ80



11 Stainless Teapot Strainer
18-8 茶こしアミ 急須用(40メッシュ)

● 70 type : 31-0061-1101
 Adaptation diameter Size (mm) : 62~69

THE JAPANESE
TABLEWARE





1 Oval Caster
 ノブル トレー (楕円)
 ●Brown : 31-0063-0101
 Size (mm) : 270×110×H20



2 Worcester Sauce Pot
 ノブル ソースさし
 ●Brown : 31-0063-0201
 Size (mm) : φ65×H129 Capacity : 220cc

3 Soy Sauce Pot
 ノブル しょう油さし
 ●Brown : 31-0063-0301
 Size (mm) : φ61×H113 Capacity : 150cc



4 Salt and Pepper Pot
 ノブル 塩・胡椒入れ
 ●Brown : 31-0063-0401
 Size (mm) : φ52×H96 Capacity : 90cc

5 Toothpick Pot
 ノブル 楊枝入れ
 ●Brown : 31-0063-0501
 Size (mm) : φ52×H88 Capacity : 40cc



6 Sesame Grinder
 ノブル ごますり器
 ●Brown : 31-0063-0601
 Size (mm) : φ60×H138 Capacity : 150cc

7 Tonkatsu(cutlet)Pot
 ノブル とんかつソース入れ
 ●Brown : 31-0063-0701
 Size (mm) : 106×75×H137 Capacity : 320cc



8 Napkin Stand (Charred Cedar)
 木製ナフキン立 黒焼杉
 ●31-0063-0801
 Size (mm) : W103×D75×H120



9 Menu Book Stand (Charred Cedar)
 メニュー立て 黒焼杉
 ●31-0063-0901
 Size (mm) : W103×D75×H120
 Groove width : 25 mm

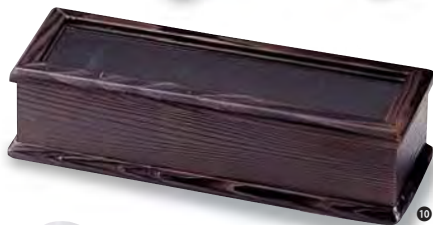

10 Chopsticks Case (Charred Cedar)
 箸箱 黒焼杉
 ●31-0063-1001
 Size (mm) : 290×100×H75



11 Chopsticks Stand (Charred Cedar)
 箸立て(角) 黒焼杉
 ●31-0063-1101
 Size (mm) : 90×90×H135



12 Caster Tray(L) (Charred Cedar)
 カスター-盆(大) 浅 黒焼杉
 ●31-0063-1201
 Size (mm) : 260×140×H25
 ※ Container not included.



13 Caster Tray(S) (Charred Cedar)
 カスター-盆(小) 浅 黒焼杉
 ●31-0063-1301
 Size (mm) : 210×120×H25



1 Wooden Toothpick Pot (Dark Brown)
ようじ立て(丸)ダークブラウン

● 31-0064-0101
Size (mm) : $\phi 53 \times H60$



2 Wooden Red Cayenne Pepper Pot
木製七味入れ

● Gourd-shaped Type : 31-0064-0201
Size (mm) : $\phi 58 \times H110$

3 Wooden Red Cayenne Pepper Pot
木製七味入れ

● Barrel Type : 31-0064-0301
Size (mm) : $\phi 55 \times H80$



4 Plastic Chopsticks Case with Cater
ABS 箸箱・カスター

● Black : 31-0064-0401
● Red : 31-0064-0402

Size (mm) : $W250 \times D105 \times H65$
・ Holds chopsticks up to 23 cm long.



5 Menu Stand (with Caster)
メニュー立(カスター付)

● 31-0064-0501
Size (mm) : $W269 \times D150 \times H130$
Groove width : 10 mm

Set example



6 Gari(Ginger Pickles in Vinegar)Pot
元禄ガリ入(小) 黒淵朱

● 31-0064-0601
Size (mm) : $W100 \times D100 \times H100$
Material : ABS resin



7 Nonslip Black Tray with Rim
清流長手木目盆 黒天朱SL(ノンスリップ加工)

W×D×H (mm)
● Shaku 3 : $394 \times 284 \times 15$ 31-0064-0701
● Shaku 5 : $456 \times 328 \times 15$ 31-0064-0702
Material : ABS resin



8 ABS Dark Wood-grain Tray
ABS製 長角盆 濃木目

● Rectangular tray : 31-0064-0801
Size (mm) : $W360 \times D250 \times H20$
Material : ABS resin



9 PP Nonslip Brown Tray
PP製 長角盆 ブラウン ノンスリップ

● Rectangular tray Brown NS : 31-0064-0901
Size (mm) : $W360 \times D250 \times H20$
Material : polypropylene

・ Non-slip products have a resin sheet, which prevents items placed on it from slipping.
Additionally, its single component casting gives it exceptional shock resistance.



10 PP Nonslip Square Brown Tray
PP製 正角盆 ブラウン ノンスリップ

● Square tray Brown NS : 31-0064-1001
Size (mm) : $W330 \times D330 \times H20$
Material : polypropylene

・ Non-slip products have a resin sheet, which prevents items placed on it from slipping.
Additionally, its single component casting gives it exceptional shock resistance.



11 Half Moon 2-sided Tray
One Side Red The Other Green
新半月両面盆 朱乾漆/グリーン乾漆

● Shaku 2 : 31-0064-1101
Size (mm) : $W363 \times D318 \times H18$
Material : ABS resin

Back

The modern chequerboard pattern is beautiful, and appropriate for both Japanese and western decors.
Made from flame and mold resistant materials

1 Menu Book LS-111
メニューブック LS-111

W×L (mm)
●Brown : 230×320 31-0065-0101
●Black : 230×320 31-0065-0102

Suitable for A-4 (4P)
Vinyl inserts : Vinyl - 55
Paper inserts : Western - 19
Inserts held in with menu pin

2 Menu Book LS-112
メニューブック LS-112

W×L (mm)
●Brown : 200×270 31-0065-0201
●Black : 200×270 31-0065-0202

suitable for B-5 (4P)
Vinyl inserts : Vinyl - 56
Paper inserts : Western - 20
Inserts held in with menu pin

3 Menu Book LS-113
メニューブック LS-113

W×L (mm)
●Brown : 278×205 31-0065-0301
●Black : 278×205 31-0065-0302

suitable for B-5 (4P)
Vinyl inserts : Vinyl - 65
Paper inserts : Western - 20
Inserts held in with menu pin

Casual Japanese-style menu book,
using Japanese unryu paper.

4 Menu Book #800-2
メニューブック #800-2

W×L (mm)
●Green : 225×310 31-0065-0401
●Red : 225×310 31-0065-0402
●Brown : 225×310 31-0065-0403

Suitable for A-4 (4P)
Vinyl inserts : Vinyl - 55
Paper inserts : Western - 19 front cover 22
Strap 36-L

5 Menu Book WA-101
メニューブック 和-101

W×L (mm)
●Red : 225×310 31-0065-0501
●Brown : 225×310 31-0065-0502

Suitable for A-4 (4P)
Vinyl inserts : Vinyl - 55
Paper inserts : Western - 19 front cover 22
Strap 36-L

6 Menu Book WA-104
メニューブック 和-104

W×L (mm)
●Red : 197×270 31-0065-0601
●Brown : 197×270 31-0065-0602

Suitable for B-5 (4P)
Vinyl inserts : Vinyl - 56
Paper inserts : Western - 20 front cover 2
Strap 36-M



1 Glass Ice Pail
アイスペール

- 31-0066-0101
- Size (mm) : ϕ 122×H130
- Accessories : Stainless steel tongs, drainage plate (stainless steel)



2 Polystyrene Ice Pail
アイスペール ハンドル付

- 31-0066-0201
- Size (mm) : ϕ 128×H139
- Capacity : 1.2ℓ



3 18-8 Stainless Ice Pail
18-8 アイスペール

- 31-0066-0301
- Size (mm) : ϕ 150×H145
- Capacity : 1.7ℓ



4 Polypropylene Insulated Ice Pail
二重アイスペール BK(黒)

- 31-0066-0401
- Size (mm) : W170×D160×H155
- Capacity : 1.3ℓ
- Material : body,Polypropylene hadle,stainless
- Accessories : Ice tongs



5 Bamboo Ice Pail
竹製 ロクロ片手桶 アイスペール(白)

- 31-0066-0501
- Size (mm) : ϕ 140×H230

6 Bamboo Ice Tongs
白竹 アイストング

- 31-0066-0601
- Size (mm) : 180



7 18-8 Stainless Water Pitcher (P Type)
18-8 ウォーターピッチャー

- 31-0066-0701
- Size (mm) : ϕ 93×H153
- Capacity : 0.7ℓ

From wine coolers, ice pails, and vases,
to hand-made style mats!



8 Ice Pail Mat #3000-1
アイスペールマット

- Black: 31-0066-0801
- Size (mm) : D150×W150
- Material : PVC leather



9 Stainless Bar Spoon
18-0 バースプーン

- L (mm)
- L: 315 31-0066-0901



10 Clear Acrylic Muddler
透明アクリルマドラー (角型) (5本入)

- 31-0066-1001
- Size (mm) : 200



11 18-8 Stainless Jigger
18-8 メジャーカップ

- B: 31-0066-1101
- Size (mm) : ϕ 43×H106
- Capacity : 43 / 27 cc



12 Bottle keeper BM-26 (10pcs/Pack)
ボトルキーパー (10枚入)

- Black: 50×38 31-0066-1201

The warmth of wood, and the solidity of crockery. These receptacles bring out the best in your food arrangement. These unique receptacles allow your cooking to shine through original presentation.



1 Wooden Shiraki Sushi Boat
白木 料理舟

WxD (mm)
●Shaku 2 : 650×250 31-0067-0101
●Shaku 3 : 910×310 31-0067-0102
Material : Spruce

2 Wooden Shiraki KAWASEBUNE Sushi Boat
白木 川舟

WxD (mm)
●H-77 : 770×220 31-0067-0201
●H-50 : 500×150 31-0067-0202



3 Wooden Sushi Geta
舟型盛台

WxDxH (mm)
●UH-600 : 635×370×100 31-0067-0301
●M : 370×265×70 31-0067-0302



4 Wooden Sushi Geta IKI
創作盛台 粋

WxDxH (mm)
●S : 210×120×23 31-0067-0401
●L : 240×150×24 31-0067-0402
●Long-S : 300×90 ×24 31-0067-0403
●Long-L : 450×90 ×30 31-0067-0404



5 Wooden Shiraki Sushi Geta
白木盛台

WxDxH (mm)
●58 : 240×150×55 31-0067-0501
●106 : 300×180×55 31-0067-0502



6 Wooden Hinoki Flat Sushi Geta
ひのき Hi美林盛皿

WxDxH (mm)
●M : 240×150×30 31-0067-0601
●L : 300×180×30 31-0067-0602



7 Wooden Hinoki Sushi Geta
(like Annual ring pattern)
檜・紅節はつり盛台

●S : 31-0067-0701
Size (mm) : W210×D120×H30



1 Wooden Sushi Tub

強化バンド摺り漆桶(目皿付)

φ×H (mm)

- 7-sun : 210×75 31-0068-0101
- 8-sun : 240×75 31-0068-0102
- 9-sun : 270×75 31-0068-0103

・ These tubs are held together with resin bands, so there is no need to worry about the bands slipping.



2 Wooden Decoration Vat

ひのき京彩敷

W×D×H (mm)

- 7-sun : 210×210×45 31-0068-0201
- 8-sun : 240×240×51 31-0068-0202



3 Wooden Footed Decoration Vat

ひのき高台京彩敷 8寸

- 31-0068-0301

Size (mm) : W240×D240×H80



5 Wooden Shiraki and Red Decoration Vat

白木 デリカバット 両面内朱

W×D×H (mm)

- M : 365×272×55 31-0068-0501

・ Both sides are usable (A-side, depth 53 mm, B-side, depth 15 mm)

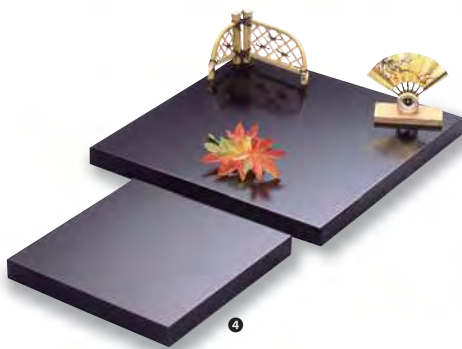

4 Urethane Black Decoration Tray

黒塗飾り台(ウレタン仕上)

W×D×H (mm)

- L : 300×300×20 31-0068-0401
- M : 200×200×20 31-0068-0402

These ice bowls are perfect for a glacial look.



6 Aluminium Ice Mold-Boat

舟型製氷器

- 31-0068-0601

finished Size (mm) : 245×135×H50

7 Aluminium Ice Mold-Mt.Fuji(Crash Ice Type)

富士山型製氷器(クラッシュヤータイプ)

- 31-0068-0701

finished Size (mm) : 200×150×H120

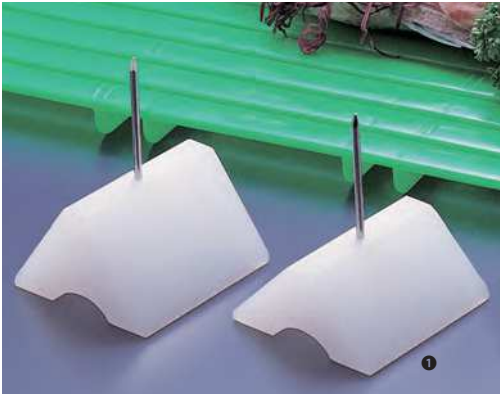

1 Plastic Pillow for Sashimi(raw fish)
(1set 2pcs)

PC 透造り用マクラ (2ヶ1組)

W×D×H (mm)

- L : 70×65×40(55) 31-0069-0101
- M : 70×65×30(50) 31-0069-0102

The figure displayed in the brackets is the length of the stainless steel spike.



2 Wooden HAGI SUDARE
萩すだれ

W×D×H (mm)

- M : 130×240 31-0069-0201
- S : 95 ×150 31-0069-0202

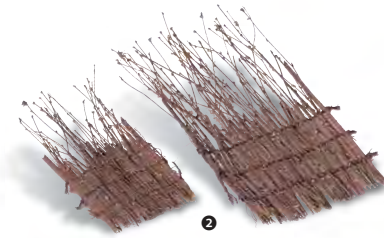

3 Regular Tempura Paper
(500 Sheets/Pack)

天ぷら敷紙(500枚入) 並

- 31-0069-0301

Size (mm) : 197×218

※ This product is not oil resistant.



4 Oil Resistant Tempura Thick Paper
(500 Sheets/Pack)

天ぷら敷紙(500枚入) 耐油 厚口

- 31-0069-0401

Size (mm) : 197×218



The tempura on the left was placed on regular tempura paper. The tempura on the right was placed on oil resistant tempura paper. The oil resistant type absorbs hardly any oil, even after a long time has passed. Ideal for wedding receptions and parties.

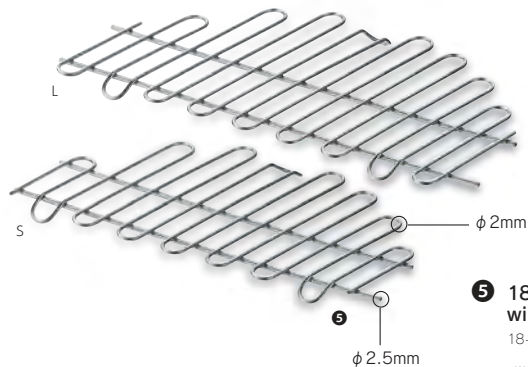

5 18-8 Stainless Tonkatsu(cutlet) wire net

18-8 ワイヤー半月型 盛付網

W×D×H (mm)

- L : 190×98×8 31-0069-0501
- S : 170×88×8 31-0069-0502

・ This is not metal mesh!! It uses wires, so it is safe, hygienic and easy to clean.



1 Wooden Serving Spoon
田舎杓子

- φ×L (mm)
 ● L : 82×295 31-0070-0101
 ● S : 65×197 31-0070-0102

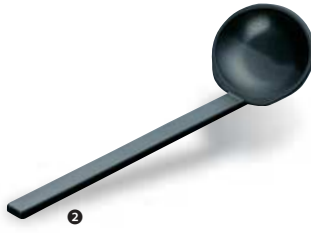

2 Plastic Serving Spoon
SPS 田舎杓子

- Black : 31-0070-0201
 Size (mm) : W70×L60
 Handle length : 175 mm

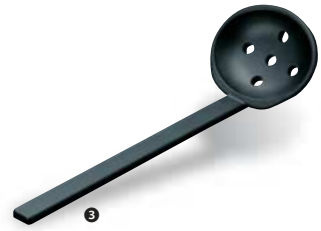

3 Plastic Serving Slotted Spoon
SPS 田舎杓子 (穴あき)

- Black : 31-0070-0301
 Size (mm) : W70×L60
 Handle length : 175 mm



4 Wooden Handle Spoon
ローズ柄 卓上お玉

- φ×L (mm)
 ● Not slotted : 70×175 31-0070-0401
 ● Slotted : 70×175 31-0070-0402



5 Plastic Mini Spoon
PC柄 豆お玉

- φ×L (mm)
 ● Not slotted : 59×142 31-0070-0501
 ● Slotted : 59×142 31-0070-0502



6 Bamboo Handle Mesh Skimmer
竹柄 アク取り

- 31-0070-0601
 Size (mm) : φ73×230
 · It can be used to remove lye.



7 Stainless Serving Spoon Stand
ステンレス お玉杓子スタンド

- 31-0070-0701
 Size (mm) : W98×D125×H30
 · Can be used for ladles of up to φ 85 mm.
 ※Serving Spoon Sold Separately.



8 Crab and Shrimp Fork T
エビカニフォーク T

- 31-0070-0801
 Size (mm) : 200



9 Crab and Shrimp Fork
新型カニフォーク

- 31-0070-0901
 Size (mm) : 210



10 Lobster Cracker
ロブスタークラッカー

- 31-0070-1001
 Size (mm) : 142
 · Extremely useful for splitting lobster shells.



11 Stainless Bones Pot with Hammered Texture
ステンレス ガラ入れ (槌目入り)

- φ×H (mm) (ℓ)
 ● M : 112×120 1.2 31-0070-1101
 ● S : 93 ×105 0.65 31-0070-1102



12 Stainless Bones Pot (Stacking Type)
18-0 スタッキング ガラ入れ

- S : 31-0070-1201
 Size (mm) : φ120×H125
 Capacity : 1.0ℓ



13 Plastic Squer Dish for Meat (Stacking Type)
ABS正角肉皿 黒

- W×D×H (mm)
 ● 16 cm (for 1 person) : 165×165×33 31-0070-1301
 ● 27 cm (for 5 people) : 270×270×33 31-0070-1302
 Material : Heat resistant ABS resin





1 Cast Iron Shabu-Shabu Pot ARARE

鉄しゃぶしゃぶ鍋 あられ

OD (mm)

- 21cm : φ206×H108 31-0071-0101
- 27.5cm : φ275×H100 31-0071-0102

・ The interior is black enamel



2 Cast Iron Yakishabu Pot

鉄焼きしゃぶ鍋 27cm

- 31-0071-0201
- Size (mm) : φ265×H67
- Grill pan : φ155



3 Aluminium Pot SHIROGANE

白銀鍋

OD (mm) ID (mm)

- 18cm : φ180×H85 φ150×H40 31-0071-0301
- 28cm : φ280×H130 φ235×H65 31-0071-0302

Material : Aluminium alloy

These pots can be used on either IH or gas cooktops. They can also be used as serving bowls, and even for cold dishes. Triple layered construction, with aluminum sandwiched between two types of stainless steel.



4 Stainless Clad Pot ARARE NABE

ステンレス あられ鍋

- 24cm Middle : 31-0071-0401

OD Size (mm) : φ240×H63
ID Size (mm) : φ205×H60



5 Stainless Clad Pot YUKI NABE

ステンレス ゆき鍋

- 25cm Middle : 31-0071-0501

Size (mm) : φ250×H63
ID Size (mm) : φ240×H60



6 Aluminium UDONSUKI Pot

打出うどんすき鍋

- 24cm : 31-0071-0601

ID Size (mm) : φ245×H62
Capacity : 1.2ℓ
Thickness : 3.3 mm
Material : Anodized Aluminium



7 Paper Pot KAMISUKI NABE (300 Sheets/Pack)

紙すき鍋 奉書 (300枚入)

- 24cm : 31-0071-0701

Bottom (mm) : φ110

・ We have added a triple-layered special water resistant coating to natural Japanese paper, and made this product even more difficult to burn.

※ Mesh basket sold separately.

Precautions when using the paper sukiyaki pan

- Set the paper sukiyaki pan so that the bottom lies parallel to the mesh receptacle.
- Ensure that the paper sukiyaki pan does not get stuck to the mesh receptacle. Flames from solid fuel will heat up the wires of the mesh, and if the paper sukiyaki pan touches the hot wires, it may burn, and holes may develop.
- After placing your ingredients in the paper sukiyaki pan, do not leave sitting for long periods.
- Paper sukiyaki pan - If ingredients dry out, they may stick to the bottom and burn the paper.
- Do not allow the outside of the paper sukiyaki pot or aluminum sukiyaki pot to become wet. Also, drain all water from the mesh receptacle and ensure that the paper sukiyaki pot does not overflow.

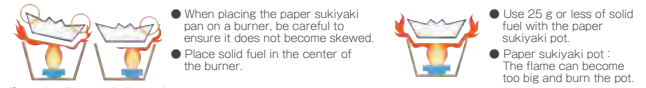

If you place it as per the image above, the flame will be diverted to the side, and the circled portions may burn.



8 Stainless net

ステンレス製 受網

- 14.5cm : 31-0071-0801

ID Size (mm) : φ135×H35
Bottom (mm) : φ110



1 KATOREYA Aluminium Konro Set

カトレヤ アルミコンロ 3点セット (M)

● 31-0072-0101

Size (mm) : φ130×H105
<Set contents> Aluminium burner, fire pan, wooden base



2 KATOREYA Aluminium Pot DANRAN

カトレヤ アルミ だんらん鍋

● 15cm : 31-0072-0201

ID Size (mm) : φ135×H45
Capacity : 0.4ℓ



3 Stainless Pot ARARE NABE

18-0 あられ鍋

● L : 31-0072-0301

ID Size (mm) : φ190×H47
Capacity : 0.9ℓ



4 Aluminium Pot AKANE

アルミ合金 水炊き鍋 蓋 16cm

● 31-0072-0401

OD Size (mm) : φ170×H85
ID Size (mm) : φ134×H55
Capacity : 0.4ℓ



5 Aluminium Shallow Pot UGUISU

アルミ 丸陶板 うぐいす

● 31-0072-0501

Size (mm) : φ195×H70
Pot : Triple fluoride coating



6 Aluminium Shallow Pot BLACK

アルミ 丸陶板 黒

● 31-0072-0601

Size (mm) : φ195×H70
Pot : Triple fluoride coating



7 Aluminium Rectangle Grill Plate SAZANAMI

アルミ 焼物プレート さざ波(角)小 M10-549

● 31-0072-0701

Size (mm) : W220×D150×H25
Aluminium alloy / triple fluoride coating
※ Burner and fire pan sold separately.



8 Elegant Konro KIWAMI

雅こんろ きわみ

● 31-0072-0801

Size (mm) : W150×D150×H90
Aluminium alloy
※ Fire pan sold separately.



9 Article Konro KIWAMI

民芸風こんろ きわみ

● 31-0072-0901

Size (mm) : W165×D145×H80
Aluminium alloy
※ Fire pan sold separately.



- An old fashioned texture has been recreated with aluminum alloy.
- It is extremely hygienic as it can be cleaned using a dishwasher.
- Due to its aluminum construction, it will not break.
- The charcoal's combustion efficiency is good, and the unique design and construction provides exceptional airflow.



1 Aluminium IROHA KONRO Square White
いろはこんろ(アルミ合金製) 大

2 Aluminium IROHA KONRO Rectangle White
いろはこんろ(アルミ合金製) 長角

●L: 31-0073-0101

Size (mm) : W152×D152×H130

※ If you will use charcoal, make sure you select the charcoal Pot.

※ The pictured mesh, charcoal pan and wooden base (with rim and legs) are sold separately.

● 31-0073-0201

Size (mm) : W240×D130×H110

※ If you will use charcoal, make sure you select the charcoal Pot.

※ The pictured mesh, charcoal pan and wooden base (with rim and legs) are sold separately.

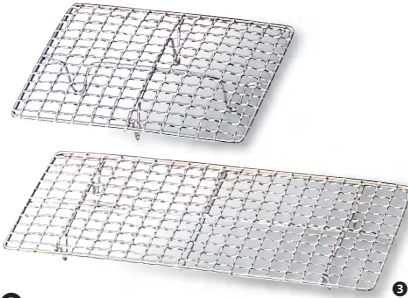

3 Stainless Cooking Net
ステンレス網

W×L (mm)

● Square-L : 150×150 31-0073-0301

● Rectangle : 240×135 31-0073-0302



4 Stainless Charcoal Pot for IROHA KONRO Square
ステンレス炭入れ (炭火仕様)

●L: 31-0073-0401

Size (mm) : φ80×H60

Material : Stainless



5 Stainless Charcoal Pot for IROHA KONRO Rectangle
いろはこんろ長角用 炭入れ (炭火仕様)

● 31-0073-0501

Size (mm) : W200×D90×H65

Material : Aluminium



6 Wooden Base for IROHA KONRO Square
敷板 (縁付脚付・炭火仕様)

●L: 31-0073-0601

ID Size (mm) : 130×130



7 Wooden Base for IROHA KONRO Rectangle
いろはこんろ長角用 敷板 (圓形燃料・炭兼用)

● 31-0073-0701

Size (mm) : W270×D160×H35

Sukiyaki pot



8 Cast Iron Sukiyaki Pot
鉄 すきやき鍋 ツル付(黒ぬり)

●20cm: 31-0073-0801

Size (mm) : φ200×H46



9 Wooden Steamer
せいろ蒸しセット

●M: 31-0073-0901

OD Size (mm) : 180×180×H90
ID Size (mm) : 120×120×H35



10 Wooden Shiraki Steamer
せいろ蒸しセット 白木

●M: 31-0073-1001

OD Size (mm) : 180×180×H80
ID Size (mm) : 120×120×H35



11 Aluminium Water Pot for Steamer
アルミ せいろ蒸し用水受け

●M: 31-0073-1101

OD Size (mm) : 155×155×H35
ID Size (mm) : 145×145



1 Aluminium Water Konro KAPPOU SUMIBITEI
 割烹 水こんろ 炭火亭(アルミ製)

● 31-0074-0101

Size (mm) : φ260×H160

- Comes with wooden base and mesh
- This burner has a water basin at the base, which prevents the base from becoming hot and ensures the charcoal will last. It uses far infrared rays for delicious cooking.

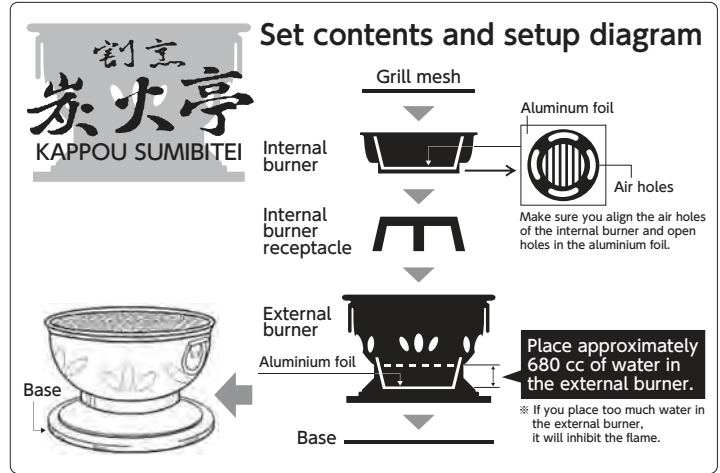

Setup procedure and precautions

1 When using this product, ensure that the base is laid in a flat location.
Place the external burner on top of the base, and line it with aluminum foil, and pour in the designated amount (refer to the setup diagram on the cover) of water. If you add too much water, it will inhibit the flame, and if you add too little, the effects of the water burner may not be apparent.

Do not insert anything other than water.
 Water inhibits heat conduction through the base of the external burner, and the steam produced softens the ingredients to their core, and draws out their natural flavors. When using this product for long periods, periodically top up the water using the air holes. Also, the aluminium foil prevents damage to internal base of the external burner.

2 Insert the internal burner.
When doing this, align the air holes on the base of the internal burner, and lay aluminium foil with holes in the relevant places. This prevents the external burner from becoming too hot, and improves charcoal combustion. It also makes it easier to clean up afterwards.

The aluminium foil prevents heat from being conducted to the external burner and improves charcoal combustion.

- 3** Place fire starters in the internal burner, and set charcoal as per the diagram on the lower right. As a guide, try to completely fill the internal burner (without the mesh being lifted up).
- 4** Check that there is nothing flammable in the vicinity before lighting the flame.
- 5** After creating a good flame, position the mesh and cook your favorite ingredients, such as meat, fish, and vegetables.
 ※ Depending on the type of charcoal used, it can take some time to achieve a good flame. Please check carefully before using.

6 Request to restaurant owners Start the fire beforehand (particularly when using binchotan charcoal), and place it directly in the internal burner (the same applies when using at home). When starting the fire indoors, we recommend placing this product not more than 60 cm below a duct, in order to aid combustion and reduce smoke.



- Items to prepare before use...**
- Charcoal
 - Fire starters
 - Fire tongs
 - Pot holder
 - Domestic aluminium foil
 - Water to put in the burner
 - Water to extinguish fires

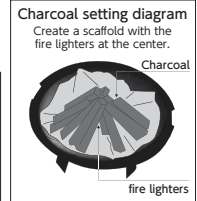

Do not use fuels such as gasoline, kerosene, gas, or alcohol to start the fire.



Charcoal burners

Charcoal burners help to transmit the Japanese spirit to the modern world. This high quality collection is for those seeking the genuine article.

These charcoal burners, increase combustion efficiency and maintain their heat for long periods. The mikawa-Konro creates a relaxed atmosphere, and is very popular. Please enjoy the flavor of old fashioned Japanese charcoal burners.



2 Ceramic MIKAWA KONRO Large Brown
 大型 三河こんろ (茶)

● 31-0074-0201

Size (mm) : φ270×H165

Accessories : Planking , Grid

3 Ceramic MIKAWA KONRO Brown
 三河こんろ (茶)

● 31-0074-0301

Size (mm) : φ220×H165

Accessories : Planking , Grid



1 Cast Iron Steak Plate with Wooden Base KOBAN

鉄 ステーキ皿 小判

●S 24cm : 31-0075-0101

Size (mm) : W240×D146×H23

<Special handles sold separately>



2 Cast Iron Steak Plate with Wooden Base ROUND

鉄 ステーキ皿 丸型

●L 22cm : 31-0075-0201

Size (mm) : W220×H23

<Special handles sold separately>



3 Cast Iron Steak Plate with Wooden Base DEEP ROUND

鉄 ステーキ皿 深型丸

●L 20cm : 31-0075-0301

Size (mm) : φ200×240×H36



4 Cast Iron Steak Plate with Wooden Base ETSUKI

鉄 ステーキ皿 柄付

●S 17cm : 31-0075-0401

Size (mm) : φ176×276×H46



5 Cast Iron Casserole

ココット鍋

●10cm : 31-0075-0501

Size (mm) : φ100×H46

Capacity : 200 cc

Weight : 0.8 kg

・ Due to this pot's cast iron construction, it has excellent heat retention.

・ Can be taken straight from the oven and placed on the table instead of crockery, without then need to transfer the food to a plate.



6 Handle for Steak Plate

ステーキ皿用 ハンドル

● 31-0075-0601

PETIT PAN SERIES

These commercial sized pans have been beautifully reproduced in this genuine petit pan series. This line-up will make your table trendy by allowing you to bring your food to the table in the pan. These pans have countless uses, from holding dressings and sauces at a buffet, to holding toppings.



7 Copper Petit Sauce Pan

銅 プチパン

ID×H (mm)	(cc)	
●8cm : φ 80×42	200	31-0075-0701
●9cm : φ 90×46	280	31-0075-0702
●10cm : φ100×52	380	31-0075-0703
●12cm : φ120×52	500	31-0075-0704



8 18-8 Stainless Petit Sauce Pan

18-8 プチパン

ID×H (mm)	(cc)	
●8cm : φ 80×40	200	31-0075-0801
●9cm : φ 90×45	280	31-0075-0802
●10cm : φ100×50	380	31-0075-0803
●12cm : φ120×50	500	31-0075-0804



9 18-8 Stainless Gravy Boat(M-Type)

18-8 M型 ソースポット

●L : 31-0075-0901

Size (mm) : W160×D90×H110
Capacity : 300 cc



10 18-8 Stainless DAIANA Sauce Ladle

18-8 ダイアナ(オールミラー仕上)

● 31-0075-1001

Size (mm) : 160



PETIT PAN CHINESE STYLE

Mini versions of the Chinese implements that you are familiar with are provided in this petit series. These implements have multiple uses, from serving dishes such as dim sum or dessert, to holding seasonings and sauces. They are the ideal size for holding amuse bouche at a Chinese buffet. The gold plating is anti-bacterial, corrosion resistant and durable.



1 18-8 PETIT Wok Pan

18-8 プチ中華鍋

ID×H (mm) (ℓ) (g)
●10cm : 102×28 0.12 63 31-0076-0101

2 Gold Plated 18-8 PETIT Wok Pan

18-8 プチ中華鍋 金メッキ付

ID×H (mm) (ℓ) (g)
●10cm : 102×28 0.12 63 31-0076-0201



3 18-8 PETIT Peking Wok Pan

18-8 プチ北京鍋

ID×H (mm) (ℓ) (g)
●10cm : 102×138×30 0.12 74 31-0076-0301

4 Gold Plated 18-8 Peking Wok Pan

18-8 プチ中華鍋 金メッキ付

ID×H (mm) (ℓ) (g)
●10cm : 102×138×30 0.12 74 31-0076-0401



5 18-8 PETIT Wok Stand

18-8 プチ中華受け台

● 31-0076-0501

Size (mm) : φ85×H18

・ Stand for petit wok, and petit Peking wok
Stabilizes unsteady woks.

6 Gold Plated 18-8 PETIT Wok Stand

18-8 プチ中華受け台 金メッキ付

● 31-0076-0601

Size (mm) : φ85×H18

・ Stand for petit wok, and petit Peking wok
Stabilizes unsteady woks.



7 18-8 Lid for PETIT Steamer

18-8 プチセイロ 蓋

ID×H (mm)
●9cm : 90×30 31-0076-0701

8 Gold Plated 18-8 Lid for PETIT Steamer

18-8 プチセイロ 蓋 金メッキ付

ID×H (mm)
●9cm : 90×30 31-0076-0801



9 18-8 PETIT Steamer

18-8 プチセイロ 身

ID×H (mm)
●9cm : 87×40 31-0076-0901

10 Gold Plated 18-8 PETIT Steamer

18-8 プチセイロ 身 金メッキ付

ID×H (mm)
●9cm : 87×40 31-0076-1001



11 18-8 PETIT Water Pan

18-8 プチセイロ鍋

● 31-0076-1101

Size (mm) : φ97×54

Capacity : 0.18 ℓ

Weight : 110 g

12 Gold Plated 18-8 PETIT Water Pan

18-8 プチセイロ鍋 金メッキ付

● 31-0076-1201

Size (mm) : φ97×54

Capacity : 0.18 ℓ

Weight : 110 g

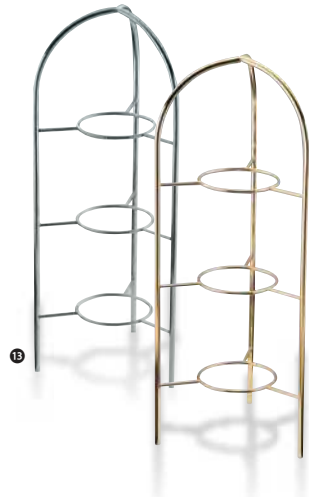

13 18-8 PETIT PAN 3Tiers Stand

18-8 プチ中華シリーズ用3段スタンド

● 31-0076-1301

Size (mm) : W106×D122×H315

・ Allows you to display petit woks and petit Peking woks.

14 Gold Plated 18-8 PETIT PAN 3Tiers Stand

18-8 プチ中華シリーズ用3段スタンド 金メッキ付

● 31-0076-1401

Size (mm) : W106×D122×H315

・ Allows you to display petit woks and petit Peking woks.



1 18-8 Stainless Pick Forks SPIRAL(6pcs/Pack)
18-8 スパイラル ピック(6本入)

● 31-0077-0101

2 Gold Plated 18-8 Pick Forks SPIRAL(6pcs/Pack)
18-8 スパイラル ピック金メッキ(6本入)

● 31-0077-0201

Size (mm) : 90
· A bite-size meal is directed lovelily.

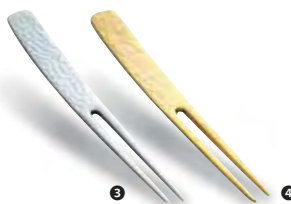

3 18-8 Stainless Hammered Pick Forks KANZASHI(6pcs/Pack)
18-8 かんざしピックフォーク極目(6本入)

● 31-0077-0301

4 Gold Plated 18-8 Hammered Pick Forks KANZASHI(6pcs/Pack)
18-8 かんざしピックフォーク極目金メッキ(6本入)

● 31-0077-0401

Size (mm) : 90
· This Japanese pick fork is ideal for fruit and Japanese sweets.

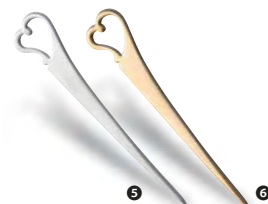

5 18-8 Stainless Picks HEART(6pcs/Pack)
18-8 ハート ピック(6本入)

● 31-0077-0501

6 Gold Plated 18-8 Picks HEART(6pcs/Pack)
18-8 ハート ピック金メッキ(6本入)

● 31-0077-0601

Size (mm) : 90
· The grip is shaped like a heart, making this item highly fashionable.



7 Acrylic Ramen Spoon
アクリル 平型ラーメン レンゲ

L×W (mm)

● Vermillion : 175×44 31-0077-0701

· This comfortable and easy to use design is ideal for noodles such as ramen, and other dishes such as fried rice.



8 Melamine Ramen Spoon
メラミン レンゲ

L×W (mm)

● Vermillion : 175×40 31-0077-0801

● Celadon green : 175×40 31-0077-0802



9 Melamine Ramen Spoon Rest
メラミン レンゲ置き

W×D (mm)

● Vermillion : 56×92×25 31-0077-0901

● Celadon green : 56×92×25 31-0077-0902

These highly durable chopsticks will not absorb water, therefore the grain will not pull up, and they will not discolour. These items may be washed and dried in hot dishwashers. Perfect for commercial use.



10 Wooden Chopsticks SHIZUKU
(10 Pairs/Pack)
木製 しずく箸(10膳入)

L (mm)

● Black (SUMIAJI) : 230 31-0077-1001

● Vermillion (AKAMO) : 230 31-0077-1002

Material : Birch



11 Wooden Thin Chopsticks
(10 Pairs/Pack)
木製 極細箸(10膳入)

L (mm)

● Black (SUMIAJI) : 235 31-0077-1101

● Vermillion (AKAMO) : 235 31-0077-1102

Material : Birch



12 18-8 Stainless Chopsticks
Checked Pattern
18-8 ステンレス箸 格子模様入

● 31-0077-1201

Size (mm) : 223

· The internal (hollow) structure creates lightness.



Checked pattern



13 Aluminium Chopsticks Rest
Square
アルミ 箸置き 角

● 31-0077-1301

Size (mm) : W60×D15×H13



14 ABS Chopsticks Rest (10 pcs/Pack)
ABS箸置き 六角用(10個入)

● Vermillion : 31-0077-1401

Size (mm) : W19×D54×H14

· This item doubles as a chopstick holder by inserting chopsticks into the hole.

· You can choose the position at which the chopsticks are held by changing the end you



1 Wooden Demitasse Spoon
木製 デミ Spoon

- Dark brown : 31-0078-0101
- Natural : 31-0078-0102

Size (mm) : 22×125

2 Wooden Dessert Spoon
木製 デザート Spoon

- Dark brown : 31-0078-0201
- Natural : 31-0078-0202

Size (mm) : 26×125



3 Wooden Spoon(S)
木製 Spoon(小)

- Dark brown : 31-0078-0301
- Natural : 31-0078-0302

Size (mm) : 30×140

4 Wooden Ramen Spoon
木製 レンゲ Spoon

- Dark brown : 31-0078-0401
- Natural : 31-0078-0402

Size (mm) : 40×165



5 Wooden Spoon(M)
木製 Spoon(中)

- Dark brown : 31-0078-0501
- Natural : 31-0078-0502

Size (mm) : 36×170

6 Wooden Spoon(L)
木製 Spoon(大)

- Dark brown : 31-0078-0601
- Natural : 31-0078-0602

Size (mm) : 45×200

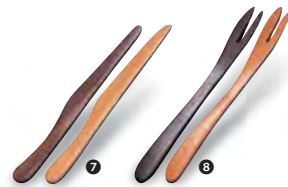

7 Wooden Pastry Knife
木製 菓子ナイフ

- Dark brown : 31-0078-0701
- Natural : 31-0078-0702

Size (mm) : 125

8 Wooden Pastry Fork
木製 菓子フォーク

- Dark brown : 31-0078-0801
- Natural : 31-0078-0802

Size (mm) : 130



9 Wooden Butter Knife
木製 バターナイフ

- Dark brown : 31-0078-0901
- Natural : 31-0078-0902

Size (mm) : 150

10 Wooden Fork(S)
木製 フォーク(小)

- Dark brown : 31-0078-1001
- Natural : 31-0078-1002

Size (mm) : 23×150



11 Wooden Fork(M)
木製 フォーク(中)

- Dark brown : 31-0078-1101
- Natural : 31-0078-1102

Size (mm) : 25×175

12 Wooden Fork(L)
木製 フォーク(大)

- Dark brown : 31-0078-1201
- Natural : 31-0078-1202

Size (mm) : 28×210



13 ABS Chawan-mushi Spoon Red
茶碗蒸し Spoon 朱塗

- 31-0078-1301

Size (mm) : 132×27
Material : ABS resin
Heat resistant up to : 60°C

14 ABS Chawan-mushi Spoon TAME
茶碗蒸し Spoon 溜塗

- 31-0078-1401

Size (mm) : 132×27
Material : ABS resin
Heat resistant up to : 60°C

15 ABS Chawan-mushi Spoon Dark Brown
茶碗蒸し Spoon 古代漆刻塗

- 31-0078-1501

Size (mm) : 132×27
Material : ABS resin
Heat resistant up to : 60°C



16 Acrylic Chawan-mushi Spoon
Brown Straight Type
えびす平 Spoon 茶

- 31-0078-1601

Size (mm) : 132×26
Material : Acrylic resin

17 Acrylic Chawan-mushi Spoon
Brown Angle Type
えびす鶴首 Spoon 茶

- 31-0078-1701

Size (mm) : 131×26
Material : Acrylic resin



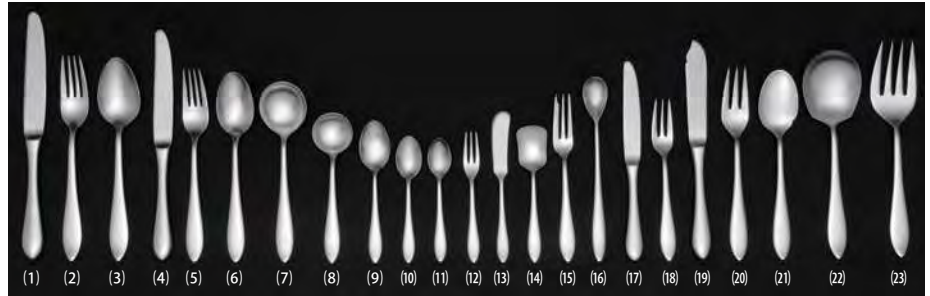

① 18-8 Stainless KYS LATINA

KYS18-8 ラティナーナ(ミラー仕上)

		L (mm)			L (mm)
● Table Knife (H.H)	: 250	31-0079-0101	● Butter Spreader	: 151	31-0079-0113
● Table Fork	: 200	31-0079-0102	● Icecream Spoon	: 133	31-0079-0114
● Table Spoon	: 200	31-0079-0103	● Cake Fork	: 164	31-0079-0115
● Dessert Knife (H.H)	: 232	31-0079-0104	● Soda Spoon	: 181	31-0079-0116
● Dessert Fork	: 188	31-0079-0105	● Fruit Knife (H.H)	: 200	31-0079-0117
● Dessert Spoon	: 186	31-0079-0106	● Fruit Fork	: 160	31-0079-0118
● Dessert Soup Spoon	: 176	31-0079-0107	● Fish Knife (H.H)	: 221	31-0079-0119
● Bouillon Spoon	: 147	31-0079-0108	● Fish Fork	: 188	31-0079-0120
● Tea Spoon	: 138	31-0079-0109	● Fish Souce Spoon	: 187	31-0079-0121
● Coffee Spoon	: 124	31-0079-0110	● Serving Spoon	: 203	31-0079-0122
● Demitasse Spoon	: 121	31-0079-0111	● Serving Fork	: 214	31-0079-0123
● Cocktail Fork	: 127	31-0079-0112			

※ Items marked with (H.H) have a hollow handle.



② 18-8 Stainless TAKUMI

18-8 匠(オールサテン仕上)

		L (mm)			L (mm)
● Dessert Knife	: 207	31-0079-0201	● Serving Spoon	: 208	31-0079-0213
● Dessert Fork	: 182	31-0079-0202	● Serving Fork	: 208	31-0079-0214
● Dessert Spoon	: 180	31-0079-0203	● Serving Spatula	: 207	31-0079-0215
● Tea Spoon	: 134	31-0079-0204	● Serving Spatula with Hole	: 207	31-0079-0216
● Coffee Spoon	: 121	31-0079-0205	● Serving Spatula Long Type	: 324	31-0079-0217
● Cocktail Fork	: 125	31-0079-0206	● Serving Spatula with Hole Long Type	: 324	31-0079-0218
● Butter Knife	: 149	31-0079-0207	● Mini Renge	: 97	31-0079-0219
● Icecream Spoon	: 130	31-0079-0208	● Fruit Fork	: 154	31-0079-0220
● Cake Fork	: 145	31-0079-0209	● Cake Spoon	: 150	31-0079-0221
● Melon Spoon	: 150	31-0079-0210	● Soda Spoon	: 193	31-0079-0222
● Large Tea Spoon	: 151	31-0079-0211	● Muddler	: 184	31-0079-0223
● Bouillon Spoon	: 150	31-0079-0212			



Choose the right softness and size for your needs.



1 KISOKOMA Wooden Handle White Sauce Brush

木曾駒印 白ハケ(山羊)

● 31-0080-0101

Size (mm) : 221
Brush Size (mm) : W30×L34

2 KISOKOMA Wooden Handle Horse Hair Sauce Brush

木曾駒印 タレハケ(馬・鬃毛・茶色)

● 31-0080-0201

Size (mm) : 228
Brush Size (mm) : W30×L17



3 Silicone Sauce Brush

シリコン塗りばけ

● 31-0080-0301

Size (mm) : W42×L190 Brush : 30 mm
Heat resistance : Bristles / 200°C Handle / 180°C

4 Bamboo Handle Sushi Brush

竹柄 寿司はけ

● 31-0080-0401

Size (mm) : W10×L150 Brush : 13 mm
・ Useful for applying sauce to sushi ingredients.

1 White Sauce Brush

This brush is generally used for cooking. It uses white goat wool, which provides good adherence when brushing on ingredients. This product is useful for a broad range of food preparation, including Japanese food, western food, confectionary, and baking.

2 Horse Hair Sauce Brush

This brush uses the soft body hair of horses, which allows you to brush directly onto your ingredients without damaging them. This product is suitable for sushi and Japanese food.

3 Silicone Sauce Brush

This brush is highly heat resistant, and the bristles will not come out. Cleaning is easy, and it is very hygienic. Use this brush for ingredients such as sauces, egg yolks, melted butter, and jam.

This product is corrosion resistant, which makes it ideal for holding okonomiyaki sauce, or eel sauce.

Can be used for many purposes, such as okonomiyaki and yakisoba.



5 Stainless Turner with Wooden Handle

木柄 起し金

- S : W63 ×L177 31-0080-0501
- L : W75 ×L191 31-0080-0502
- 3.5-sun : W105×L247 31-0080-0503
- 4-sun : W120×L271 31-0080-0504



6 Oiling Brush Set with Spring

18-0 ハネ付油引きセット

- S : 31-0080-0601

Size (mm) : φ77×H120



7 Molybdenum Steel Sauce Pot

モリブデン角タレ入れ

- 31-0080-0701

Size (mm) : W90×D90×H85

Safer and less abrasive alternative to steel wool, requiring very little detergent. Use these items on any surface or scrub vegetables to retain important minerals.



8 Professional KITCHEN CLEAN Scrubber

KYS 業務用布たわしキッチンクリーン

- 31-0080-0801

Size (mm) : 100×900
Material : Cotton, artificial stone (abrasive)

- ・ Perfect for scrubbing stubborn grime on cooking and food preparation devices.
- ・ Unlike metal scourers, this product is safe in that it will not rust or tear off and cause injury!!

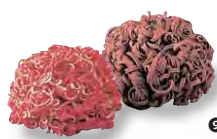

9 SAND CLEAN Scrubber(10pcs/Pack)

業務用布たわしサンドクリーン(10個入)

- Medium(S) Red : 31-0080-0901
- Rough Brown : 31-0080-0902

- ・ This product is ideal for cleaning rust and burnt on grease from stoves and cooking surfaces. It is also useful for cleaning tiles etc.

Sand clean is made from cloth, so it is gentle to your hands, will not cause cuts, and will not rust.

※ Moisten before use.



10 Palm Scrubber

パームたわし

- (g)
- L : 75 31-0080-1001
- M : 49 31-0080-1002

All natural, multi-purpose traditional Japanese brush. Perfect for cleaning hangiri wooden bowls.

Highly absorbent type
〈 Use for defrosting frozen ingredients or for freezing 〉



11 Pichitto Dehydrating Sheets

業務用ピチット 32R(32枚ロール)

- 31-0080-1101

Size (mm) : 250×350
※ Perforated

- ・ Just wrap food in this absorbent cooking sheet to absorb any excess moisture. Apart from preventing sogginess and bringing out the flavor of food, it also suppresses odors caused by excess moisture, as well as the progress of spoilage.



12 RED KEEPER Tuna Paper

業務用レッド キーパー

- Size (mm)
- L(20 Sheets) : 500×350 31-0080-1201

- ・ The absorbency and humidity regulation provided by this sheet eliminates excess moisture. It will not sweat or dry out in the refrigerator. This sheet helps chilled ingredients, such as meat and shellfish to maintain their freshness in the refrigerator.
- ・ The Red keeper originally gained its name from its ability to keep the redness of time sensitive proteins such as tuna.



13 Extra-Absorbent REED PAPER Food Service Towels(12rolls/case)

業務用リードペーパー(12ロール入)

- ID×H (mm)
- L : 385×240 31-0080-1301

Sheets : 75 sheets × 1 roll
12 rolls per case

- ・ Reed Paper is an all-natural and extra adsorbent food service towel, popular among Japanese professionals. For even the most, it's soft texture makes it usable

BENTO BOXES

Shokado bento were invented during the Edo period. they use lidded boxes with a cross shaped central divider and a high rim. The divider allows you to include various foods such as sashimi, grilled items, and rice, without the flavors mingling, creating an informal kaiseki-style meal. This compactness and convenience is an ideal match for modern cuisine, and we have many original varieties.



1

1 Shaku-3 Black SHOKADO Bento Box with Red Edge (without Partition)

尺3 千筋舟淵松花堂 黒淵朱 仕切別

● 31-0081-0101

Size (mm) : W378×D260×H63
Material : ABS resin



2

2 Shaku-3 Black SHOKADO Bento Box with Red Line (without Partition)

尺3 木目松花堂 黒天朱 仕切別

● 31-0081-0201

Size (mm) : W376×D260×H63
Material : ABS resin



3

3 Shaku-3 Brown SHOKADO Bento Box (without Partition)

尺3 布目松花堂 溜 仕切別

● 31-0081-0301

Size (mm) : W382×D264×H65
Material : ABS resin



4

4 Shaku-3 Black SHOKADO Bento Box (without Partition)

尺3 DX松花堂 黒源氏香 仕切別

● 31-0081-0401

Size (mm) : W378×D260×H63
Material : ABS resin



Set example

5

5 Shaku-3 Hyotan (Gourd) Partition for SHOKADO Bento Box

尺3 松花堂用 ひょうたん 仕切 朱天黒

● 31-0081-0501

Size (mm) : W353×D235×H39
Material : ABS resin



Set example

6

6 Shaku-3 N-Type Partition for SHOKADO Bento Box

尺3 松花堂用 N仕切 黒内朱

● 31-0081-0601

Size (mm) : W353×D236×H40
Material : ABS resin



Set example

7

7 Shaku-3 A-Type Partition for SHOKADO Bento Box

尺3 松花堂用 A仕切

● 31-0081-0701

Size (mm) : W352×D235×H40
Material : ABS resin



Set example

8

8 Shaku-3 B-Type Partition for SHOKADO Bento Box

尺3 松花堂用 B仕切

● 31-0081-0801

Size (mm) : W352×D235×H40
Material : ABS resin



① ABS Black and Red Bowl for Bento Box

4寸 丸鉢(段付)黒内朱

● 31-0082-0101

Size (mm) : φ115×H42
Material : ABS resin



② ABS Black Bowl for Bento Box

4寸 丸鉢(段付)黒天朱

● 31-0082-0201

Size (mm) : φ115×H42
Material : ABS resin



③ ABS Bowl BOKASHI for Bento Box

四ツ山小鉢 ピンクほかし

● 31-0082-0301

Size (mm) : W118×D118×H42
Material : ABS resin



④ ABS Bowl ORIBE for Bento Box

四ツ山小鉢 灰釉織部

● 31-0082-0401

Size (mm) : W118×D118×H42
Material : ABS resin



⑤ ABS Bowl KIKU for Bento Box

ABS 菊鉢(大)黄色

● 31-0082-0501

Size (mm) : φ114×H36
Material : ABS resin



⑥ ABS Bowl SHINTAME for Bento Box

3.5丸すかし鉢 新瀧

● 31-0082-0601

Size (mm) : φ114×H39
Material : ABS resin



⑦ ABS Black Square Bowl with Red Edge for Bento Box

角鉢 黒天朱

● 31-0082-0701

Size (mm) : W114×D114×H38
Material : ABS resin



⑧ ABS Red Square Bowl for Bento Box

角鉢 朱天黒

● 31-0082-0801

Size (mm) : W114×D114×H38
Material : ABS resin



⑨ ABS Square Bowl BOKASHI for Bento Box

満月角鉢 ピンクほかし

● 31-0082-0901

Size (mm) : W110×D110×H33
Material : ABS resin

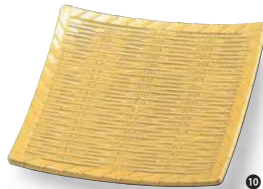

⑩ ABS Square Bamboo Plate for Bento Box

ABS 竹角皿

● 31-0082-1001

Size (mm) : W112×D112×H14
Material : ABS resin



⑪ ABS Bamboo Basket for Bento Box

新丸籠 染瀧

● 31-0082-1101

Size (mm) : φ112×H37
Material : ABS resin

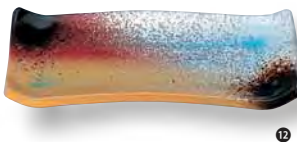

⑫ ABS Rectangle Plate SHIGARAKI for Bento Box

7.5寸 長角四方皿 信楽タタキ

● 31-0082-1201

Size (mm) : W230×D112×H25
Material : ABS resin



⑬ ABS Black and Red Rectangle Bowl for Bento Box

長手鉢 朱天黒

● 31-0082-1301

Size (mm) : W236×D116×H38
Material : ABS resin



⑭ ABS Rectangle Sashimi Bowl for Bento Box

長手刺身鉢 朱天黒

● 31-0082-1401

Size (mm) : W230×D110×H38
Material : ABS resin



⑮ Bamboo Rectangle Plate for Bento Box

長手竹皿

● 31-0082-1501

Size (mm) : W230×D110×H20
Material : Bamboo



1 8.5 Sun Black SHOKADO Bento Box with Red Edge
8.5寸 木目松花堂 黒淵朱(内塗無)(仕切別)

● 31-0083-0101
Size (mm) : W260×D260×H65
Material : ABS resin



2 8.5 Sun MAKUNOUCHI Partition for SHOKADO Bento Box
8.5寸 松花堂用 DX箱の内仕切 朱天黒

● 31-0083-0201
Size (mm) : W235×D235×H40
Material : ABS resin



3 8.5 Sun KUNOICHI Partition for SHOKADO Bento Box
8.5寸 松花堂用 くの一仕切 朱

● 31-0083-0301
Size (mm) : W235×D235×H35
Material : ABS resin



4 8.5 Sun Cross-shaped Partition for SHOKADO Bento Box
8.5寸 松花堂用 十字仕切

● 31-0083-0401
Size (mm) : W234×D234×H40
Material : ABS resin



5 8.5 Sun T-shaped Partition for SHOKADO Bento Box
(福)8.5寸 松花堂用 T字仕切 (一体物)

● 31-0083-0501
Size (mm) : W234×D120×H40
Material : ABS resin



6 Black Daiju Bento Box
大寿弁当 黒淵朱

W×D×H (mm)
● Lid : 375×135×H20 31-0083-0601
● Latticed Pattern Rectangular Lid : 375×135×H20 31-0083-0602
● Box with Triple Divider - : 362×126×H57 31-0083-0603
● Box with Divider for Sauce - : 362×126×H57 31-0083-0604
Material : ABS resin



7 Rectangle Soba Seiro
D.X角盛そばセイロ 竹

W×D×H (mm)
● Box : 207×146×H47 31-0083-0701
● Bamboo Mat : 180×120 31-0083-0702
Material : ABS resin



8 Square Soba Seiro
新D.X角ザルそばセイロ 黒天朱

W×D×H (mm)
● Box : 212×212×55 31-0083-0801
● Bamboo Mat : 170×170 31-0083-0802
Material : ABS resin

Stackable and will not take up space.



9 Soba Tsuyu Bowl
竹型つゆ入れ 根菜

● 31-0083-0901
Size (mm) : φ80×H60
Material : Melamine resin



10 Yakumi Dish
ヤクミ皿 黒天朱

● 31-0083-1001
Size (mm) : φ81×H10
Material : Melamine resin

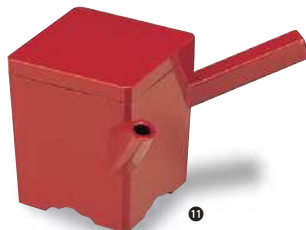

11 Sobayu Pitcher
角ゆとう(大) 朱

● 31-0083-1101
Size (mm) : W108×D108×H128
Capacity : 620 cc
Material : ABS resin

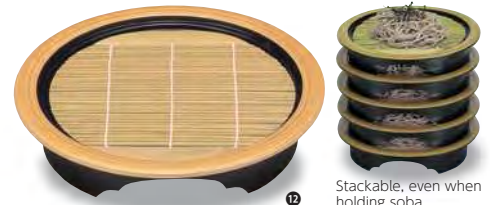

12 Round Soba Seiro
高台型丸ザルそばセイロ 白木(底板付)

φ×H (mm)
● Box : 247×48 31-0083-1201
● Bamboo Mat : 195 31-0083-1202
Material : ABS resin

Stackable, even when holding soba.

ABS resin is exceptionally shock resistant. It is resistant to breakage, even after hard impacts. The colouring also has good adherence and is resistant to peeling. It cannot be washed up in dishwasher. (Heat resistance:60C~70C)



1 Cold Sake Glass
(6 pcs/Pack)

杯 (6ヶ入)

● 31-0084-0101

Size (mm) : $\phi 68 \times H78$
Capacity : 125 cc



2 Cold Sake Glass
(6 pcs/Pack)

杯 (6ヶ入)

● 31-0084-0201

Size (mm) : $\phi 66 \times H66$
Capacity : 110 cc



3 Tall Cold Sake Glass
(6 pcs/Pack)

杯 (6ヶ入)

● 31-0084-0301

Size (mm) : $\phi 64 \times H100$
Capacity : 110 cc



4 Tall Cold Sake Glass
(6 pcs/Pack)

高杯 (6ヶ入)

● 31-0084-0401

Size (mm) : $\phi 58 \times H90$
Capacity : 65 cc



5 GUINOMI Cold Sake Glass
(6 pcs/Pack)

杯 ぐいのみ (6ヶ入)

● 31-0084-0501

Size (mm) : $\phi 58 \times H47$
Capacity : 65 cc



6 Sake Glass
(6 pcs/Pack)

酒杯 杯 (6ヶ入)

● 31-0084-0601

Size (mm) : $\phi 68 \times H37$
Capacity : 40 cc

DELICIOUS GUINOMI SERIES



7 Tin plated Copper GUINOMI Sake Cup

おいしいぐい呑み

$\phi \times H$ (mm)

● 60ml : 53×45 31-0084-0701

● 90ml : 60×52 31-0084-0702

Material : Copper / tin plating



8 Tin plated Copper Sake Tumbler

おいしいタンブラー

● 150ml : 31-0084-0801

Size (mm) : $\phi 61 \times H88$

Material : Copper / tin plating



These cups are made from tin plated copper, so the coolness of the drink is conducted well, allowing you to experience the mellow flavor of the alcohol.



Please enquire about engraving.

TOKKURI



9 Glass Sake Carafe
(6 pcs/Pack)

徳利 (6ヶ入)

● 31-0084-0901

Size (mm) : $\phi 58 \times H134$
Capacity : 180 cc



10 Glass Sake Carafe
(6 pcs/Pack)

徳利 (6ヶ入)

● 31-0084-1001

Size (mm) : $\phi 72 \times H122$
Capacity : 175 cc



11 Glass Sake Carafe
(6 pcs/Pack)

徳利 (6ヶ入)

● 31-0084-1101

Size (mm) : $\phi 70 \times H130$
Capacity : 180 cc

・ Can be used for warm drinks.

※ Do not place in the microwave or the oven,
and do not apply direct fire.



12 Glass Sake Carafe
with Ice Reservoir

冷酒カラフェ (小) (氷ポケット付)

● 31-0084-1201

Size (mm) : $\phi 96 \times H165$
Capacity : 370 cc

In Japan, cushions are placed on the tatami or on the chairs at restaurants etc. in order to convey respect for the customer.
Perfect for conveying the feel of a Japanese style pub.



① Floor Cushion IROASOBI EXE7050

色あそび 座布団 E×E7050

	W×D×H (mm)	Cover Size (mm)	
● Deep Red	: 460×460×80	500×500	31-0085-0101
● Dark Blue	: 460×460×80	500×500	31-0085-0102
● Dull Orange-Brown	: 460×460×80	500×500	31-0085-0103

Cloth material : Cotton (butcher) 100%
Stuffing : Wadding 0.6 kg (cotton 90% / polyester 10%), Urethane core 20 mm

Japanese / English / Chinese / Korean Plate



② Multilingual Plate TGP1025-1
多国語プレート TGP1025-1

- 31-0085-0201

Size (mm) : W250×H100
Thickness : 3 mm
「Sorry, we cannot exchange currencies」
Material : Acrylic resin



③ Multilingual Plate TGP1025-3
多国語プレート TGP1025-3

- 31-0085-0301

Size (mm) : W250×H100
Thickness : 3 mm
「We have Chinese-speaking staff」
Material : Acrylic resin



④ Multilingual Plate TGP1025-4
多国語プレート TGP1025-4

- 31-0085-0401

Size (mm) : W250×H100
Thickness : 3 mm
「We have English-speaking staff」
Material : Acrylic resin



⑤ Multilingual Plate TGP1025-5
多国語プレート TGP1025-5

- 31-0085-0501

Size (mm) : W250×H100
Thickness : 3 mm
「We have Korean-speaking staff」
Material : Acrylic resin

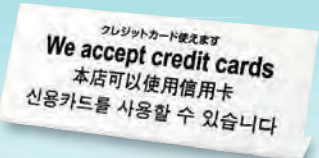

⑥ Multilingual Plate TGP1025-9
多国語プレート TGP1025-9

- 31-0085-0601

Size (mm) : W250×H100
Thickness : 3 mm
「We accept credit cards」
Material : Acrylic resin

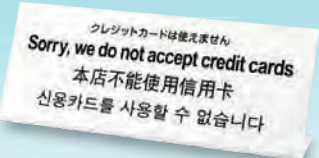

⑦ Multilingual Plate TGP1025-10
多国語プレート TGP1025-10

- 31-0085-0701

Size (mm) : W250×H100
Thickness : 3 mm
「Sorry, we do not accept credit cards」
Material : Acrylic resin



⑧ Multilingual Plate TGP1025-12
多国語プレート TGP1025-12

- 31-0085-0801

Size (mm) : W250×H100
Thickness : 3 mm
「CASHIER」
Material : Acrylic resin



⑨ Multilingual Plate TGP1025-13
多国語プレート TGP1025-13

- 31-0085-0901

Size (mm) : W250×H100
Thickness : 3 mm
「INFORMATION」
Material : Acrylic resin



⑩ Multilingual Plate TGP1025-14
多国語プレート TGP1025-14

- 31-0085-1001

Size (mm) : W250×H100
Thickness : 3 mm
「We are currently full. Please wait a moment」
Material : Acrylic resin



⑪ Multilingual Plate TGP1025-17
多国語プレート TGP1025-17

- 31-0085-1101

Size (mm) : W250×H100
Thickness : 3 mm
「Please wait for the host to take you to your table」
Material : Acrylic resin

Chochin



① KUNAGA-Chochin(Lantern)

九長提灯

- No.4204 Yakitori : 31-0086-0101
- No.4205 Ramen : 31-0086-0102
- No.4210 Izakaya (Japanese Style Pub) : 31-0086-0103
- No.4302 Sake : 31-0086-0104
- No.4304 Kushiyaki : 31-0086-0105

Size (mm) : φ240×H520
Both Sided Print



② Design Chochin(Lantern)

九長デザイン提灯

- No.9000 Ramen : 31-0086-0201
- No.9010 Sushi : 31-0086-0202

Size (mm) : φ230×H560



Red / White

③ Two-tone color's Festival Chochin

2色張分け ビニール提灯 尺丸

- Red / White : 31-0086-0301

Size (mm) : φ260×H300

Noren



④ 5 Haba Noren

5巾のれん

- No.1801 Navy : 31-0086-0401
- No.1803 Dark Red : 31-0086-0402

Size (mm) : 1,750×500
Material : KATSURAGI (Cotton)



⑤ Hangen Noren

半間のれん

- No.1809 Navy : 31-0086-0501
- No.1811 Dark Red : 31-0086-0502

Size (mm) : 850×1,200
Material : KATSURAGI (Cotton)

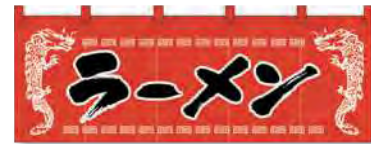

No.1120
Ramen



No.1136
Izakaya



No.1137
Izakaya

⑥ Noren

のれん

- No.1120 Ramen : 31-0086-0601
- No.1136 Izakaya(Japanese Style Pub) : 31-0086-0602
- No.1137 Izakaya(Japanese Style Pub) : 31-0086-0603

Size (mm) : 1,700×600
Material : TENJIKUMOMEN (Cotton)



KYS