

METIS-112 | PROFESSIONAL TWO-WAY FULL RANGE LOUDSPEAKER

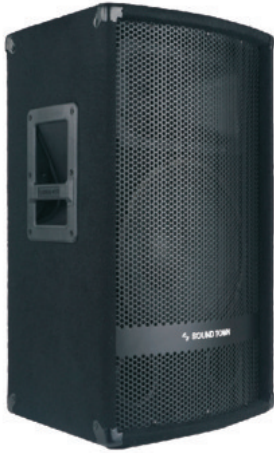

The METIS Series were designed to provide stellar professional sound but still in competitive prices. It will be your best choice combines performance and value to get the Sound Town METIS series, which stacks up with high efficient loudspeakers, titanium compression drivers and impressive power handling.

METIS family consists of full range single 12", 15", dual 12", dual 15"; 10", 12", 15" floor monitor and 15", 18" high power subwoofer are available in both passive and self-powered version. There is also a 21" super subwoofer can provided roof overturned bass.

Thanks to Sound Town NIX series premium amplifier, there are also several METIS package on choice which can help users to set up their PA system conveniently and deliver professional quality sound.

SPECIFICATIONS

SYSTEM DATA:

FREQUENCY RESPONSE: 55 Hz - 20kHz
 SENSITIVITY: 96 db (Passive)
 SPL MAX: 122 db
 DISPERSION: 105° x 60° (H x V)

LOUDSPEAKER DATA:

CONFIGURATION: 12" 2-way full range loudspeaker
 TRANSDUCER: LF: 1 x 12", HF: 1 x 1" compression driver
 IMPEDANCE: 8Ω Nominal
 POWER HANDLING: 300 / 600W
 CONNECTORS: 2 x 4 Pin Speakon®, 2 x 1/4" Jack

PHYSICAL:

CABINET CONSTRUCTION: Particle board
 MOUNTING: Stand mount on bottom
 FINISH: Carpeting

GRILL AND RIGGING COMPONENTS: Steel with anti-corrosion coat

DIMENSIONS (MM / INCH): 390 W - 350 D - 626 H / 15.3 W - 13.8 D - 24.7 H
 WEIGHT: 17.5 kg / 38.6 lb

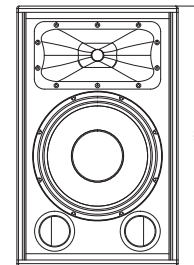

FRONT

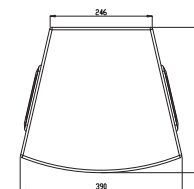

TOP

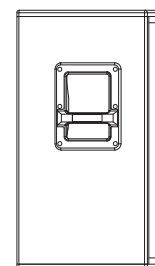

SIDE

SPL / IMPEDANCE VS FREQ.

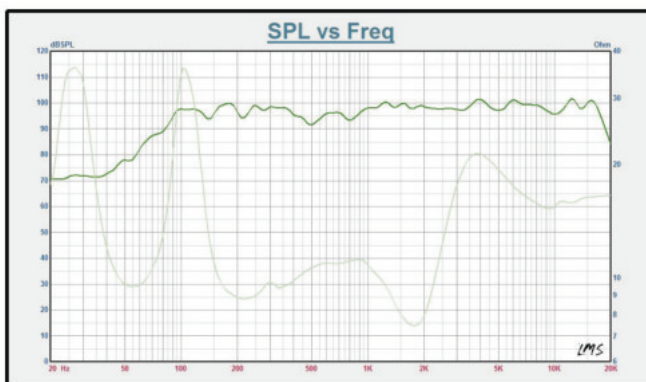

METIS-115

PROFESSIONAL TWO-WAY
FULL RANGE LOUDSPEAKER



The METIS Series were designed to provide stellar professional sound but still in competitive prices. It will be your best choice combines performance and value to get the Sound Town METIS series, which stacks up with high efficient loudspeakers, titanium compression drivers and impressive power handling.

METIS family consists of full range single 12", 15", dual 12", dual 15"; 10", 12", 15" floor monitor and 15", 18" high power subwoofer are available in both passive and self-powered version. There is also a 21" super subwoofer can provided roof overturned bass.

Thanks to Sound Town NIX series premium amplifier, there are also several METIS package on choice which can help users to set up their PA system conveniently and deliver professional quality sound.

SPECIFICATIONS

SYSTEM DATA:

FREQUENCY RESPONSE: 50 Hz - 20kHz

SENSITIVITY: 97 db (Passive)

SPL MAX: 123 db

DISPERSION: 105° x 90° (H x V)

LOUDSPEAKER DATA:

CONFIGURATION: 15" 2-way full range loudspeaker

TRANSDUCER: LF: 1 x 15", HF: 1 x 1" compression driver

IMPEDANCE: 8Ω Nominal

POWER HANDLING: 350 / 700W

CONNECTORS: 2 x 4 Pin Speakon®, 2 x 1/4" Jack

PHYSICAL:

CABINET CONSTRUCTION: Particle board

MOUNTING: Stand mount on bottom

FINISH: Carpeting

GRILL AND RIGGING COMPONENTS: Steel with anti-corrosion coat

DIMENSIONS (MM / INCH): 460 W - 381 D - 823 H / 18.1 W - 15 D - 32.4 H

WEIGHT: 19.5 kg / 43 lb

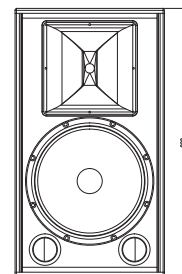

FRONT

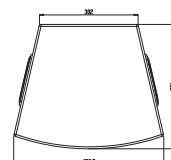

TOP

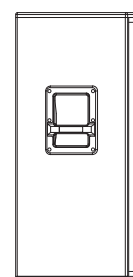

SIDE

SPL / IMPEDANCE VS FREQ.

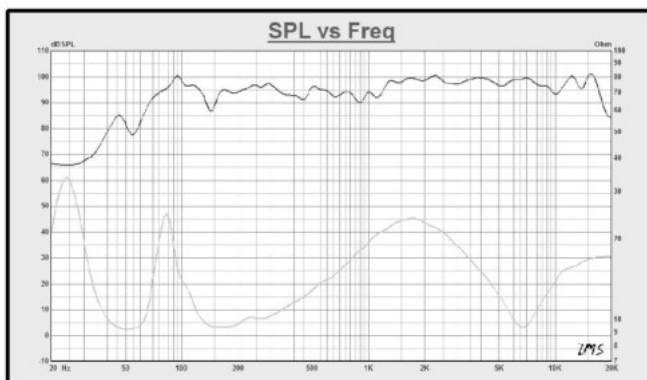

METIS-212

PROFESSIONAL TWO-WAY
FULL RANGE LOUDSPEAKER



The METIS Series were designed to provide stellar professional sound but still in competitive prices. It will be your best choice combines performance and value to get the Sound Town METIS series, which stacks up with high efficient loudspeakers, titanium compression drivers and impressive power handling.

METIS family consists of full range single 12", 15", dual 12", dual 15"; 10", 12", 15" floor monitor and 15", 18" high power subwoofer are available in both passive and self-powered version. There is also a 21" super subwoofer can provided roof overturned bass.

Thanks to Sound Town NIX series premium amplifier, there are also several METIS package on choice which can help users to set up their PA system conveniently and deliver professional quality sound.

SPECIFICATIONS

SYSTEM DATA:

FREQUENCY RESPONSE: 55 Hz - 20kHz

SENSITIVITY: 98 db (Passive)

SPL MAX: 125 db

DISPERSION: 105° x 60° (H x V)

LOUDSPEAKER DATA:

CONFIGURATION: Dual 12" 2-way full range loudspeaker

TRANSDUCER: LF: 2 x 12", HF: 1 x 1.4" compression driver

IMPEDANCE: 4Ω Nominal

POWER HANDLING: 600 / 1200W

CONNECTORS: 2 x 4 Pin Speakon®, 2 x 1/4" Jack

PHYSICAL:

CABINET CONSTRUCTION: Particle board

MOUNTING:

FINISH: Carpeting

GRILL AND RIGGING COMPONENTS: Steel with anti-corrosion coat

DIMENSIONS (MM / INCH): 390 W - 350 D - 915 H / 15.3 W - 13.8 D - 36 H

WEIGHT: 21.5 kg / 47.4 lb

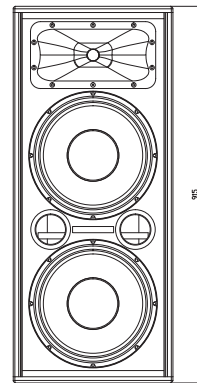

FRONT

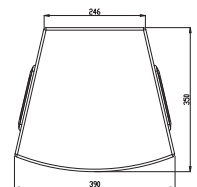

TOP

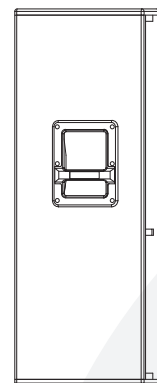

SIDE

SPL / IMPEDANCE VS FREQ.

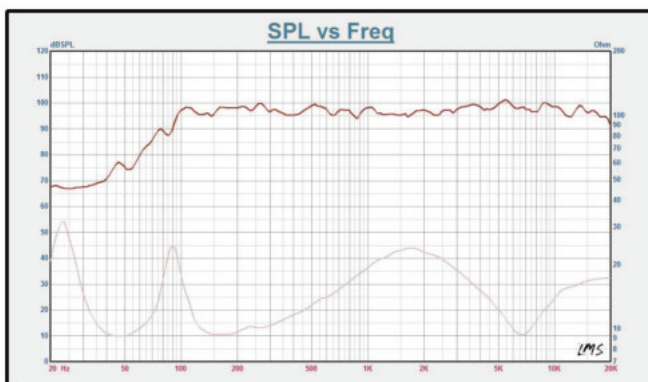

METIS-215

PROFESSIONAL TWO-WAY
FULL RANGE LOUDSPEAKER



The METIS Series were designed to provide stellar professional sound but still in competitive prices. It will be your best choice combines performance and value to get the Sound Town METIS series, which stacks up with high efficient loudspeakers, titanium compression drivers and impressive power handling.

METIS family consists of full range single 12", 15", dual 12", dual 15"; 10", 12", 15" floor monitor and 15", 18" high power subwoofer are available in both passive and self-powered version. There is also a 21" super subwoofer can provided roof overturned bass.

Thanks to Sound Town NIX series premium amplifier, there are also several METIS package on choice which can help users to set up their PA system conveniently and deliver professional quality sound.

SPECIFICATIONS

SYSTEM DATA:

FREQUENCY RESPONSE: 50 Hz - 20kHz

SENSITIVITY: 99 db (Passive)

SPL MAX: 126 db

DISPERSION: 105° x 90° (H x V)

LOUDSPEAKER DATA:

CONFIGURATION: Dual 15" 2-way full range loudspeaker

TRANSDUCER: LF: 2 x 15", HF: 1 x 1.4" compression driver

IMPEDANCE: 4Ω Nominal

POWER HANDLING: 700 / 1400W

CONNECTORS: 2 x 4 Pin Speakon®, 2 x 1/4" Jack

PHYSICAL:

CABINET CONSTRUCTION: Particle board

MOUNTING:

FINISH: Carpeting

GRILL AND RIGGING COMPONENTS: Steel with anti-corrosion coat

DIMENSIONS (MM / INCH): 460 W - 381 D - 1216 H / 18.1 W - 15 D - 47.9 H

WEIGHT: 28.5 kg / 62.8 lb

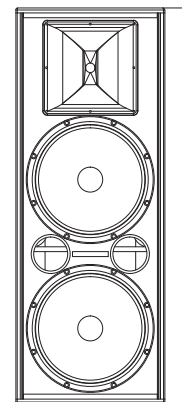

FRONT

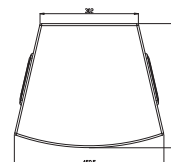

TOP

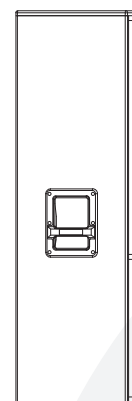

SIDE

SPL / IMPEDANCE VS FREQ.

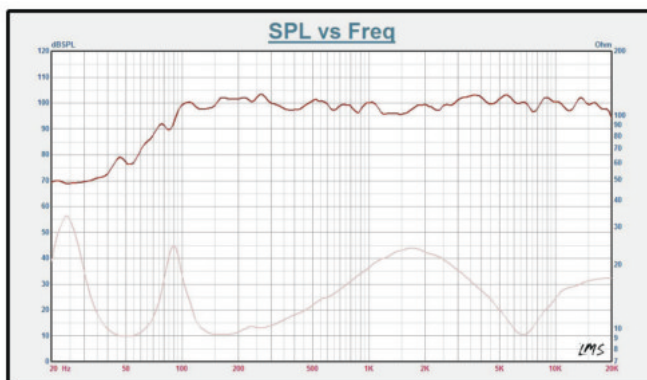

METIS-15S

HIGH POWER PASSIVE
SUBWOOFER SYSTEM



The METIS Series were designed to provide stellar professional sound but still in competitive prices. It will be your best choice combines performance and value to get the Sound Town METIS series, which stacks up with high efficient loudspeakers, titanium compression drivers and impressive power handling.

METIS family consists of full range single 12", 15", dual 12", dual 15"; 10", 12", 15" floor monitor and 15", 18" high power subwoofer are available in both passive and self-powered version. There is also a 21" super subwoofer can provided roof overturned bass.

Thanks to Sound Town NIX series premium amplifier, there are also several METIS package on choice which can help users to set up their PA system conveniently and deliver professional quality sound.

SPECIFICATIONS

SYSTEM DATA:

FREQUENCY RESPONSE: 40 Hz - 350Hz
 SENSITIVITY: 96 db (Passive)
 SPL MAX: 123 db

DISPERSION:

LOUDSPEAKER DATA:

CONFIGURATION: 15" Passive subwoofer system
 TRANSDUCER: LF: 1 x 15" (w/ 4" voice coil)
 IMPEDANCE: 8Ω Nominal
 POWER HANDLING: 400 / 800W
 CONNECTORS: 2 x 4 Pin Speakon®, 2 x 1/4" Jack

PHYSICAL:

CABINET CONSTRUCTION: Particle board, plywood reinforced
 MOUNTING: Stand mount on top
 FINISH: Carpeting
 GRILL AND RIGGING COMPONENTS: Steel with anti-corrosion coat
 DIMENSIONS (MM / INCH): 480 W - 530 D - 560 H / 18.9 W - 20.9 D - 22.1 H
 WEIGHT: 22.5 kg / 49.6 lb

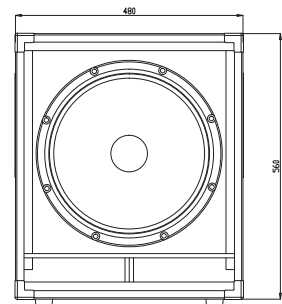

FRONT

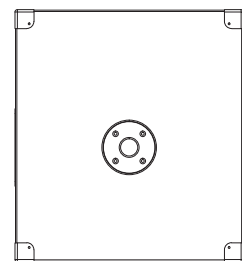

TOP

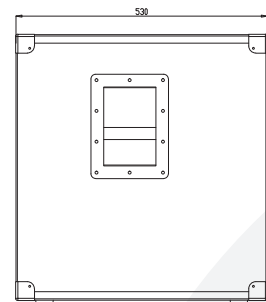

SIDE

SPL / IMPEDANCE VS FREQ.

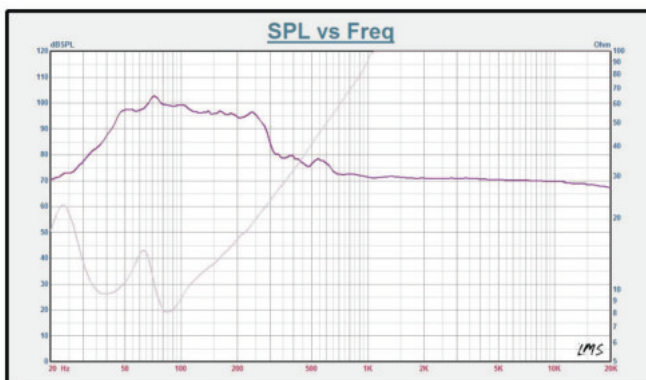

METIS-15SPW

HIGH POWER ACTIVE
SUBWOOFER SYSTEM



The METIS Series were designed to provide stellar professional sound but still in competitive prices. It will be your best choice combines performance and value to get the Sound Town METIS series, which stacks up with high efficient loudspeakers, titanium compression drivers and impressive power handling.

METIS family consists of full range single 12", 15", dual 12", dual 15"; 10", 12", 15" floor monitor and 15", 18" high power subwoofer are available in both passive and self-powered version. There is also a 21" super subwoofer can provided roof overturned bass.

Thanks to Sound Town NIX series premium amplifier, there are also several METIS package on choice which can help users to set up their PA system conveniently and deliver professional quality sound.

SPECIFICATIONS

SYSTEM DATA:

FREQUENCY RESPONSE: 40 Hz - 350Hz
 SENSITIVITY: 96 db (Passive)
 SPL MAX: 123 db
 DISPERSION: N/A

LOUDSPEAKER DATA:

CONFIGURATION: 15" High power active subwoofer
 TRANSDUCER: 1 x 15" (w/ 4" voice coil)
 IMPEDANCE: 8Ω Nominal
 POWER HANDLING: 400 / 800W

PHYSICAL:

CABINET CONSTRUCTION: Particle board, plywood reinforced
 MOUNTING: Stand mount on top
 FINISH: Carpeting
 GRILL AND RIGGING COMPONENTS: Steel with anti-corrosion coat
 DIMENSIONS (MM / INCH): 480 W - 530 D - 560 H / 18.9 W - 20.9 D - 22.1 H
 WEIGHT: 30.5 kg / 67.2 lb

AMPLIFIER:

TYPE: Class AB
 T.H.D: 0.5% (1kHz -9db)
 LOAD CAPACITY: 8Ω / 4Ω
 INPUT IMPEDANCE: 1.2V / 20KΩ
 CONNECTOR: 2 x XLR female & 1/4" combo with 2 x XLR male loop out, RCA
 CONTROL: Master volume, LF extension, LPF, Polarity, LED on / off
 VOLTAGE SELECTION: 100-240V AC, 50 / 60Hz

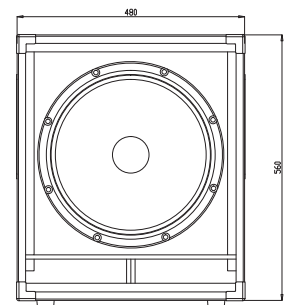

FRONT

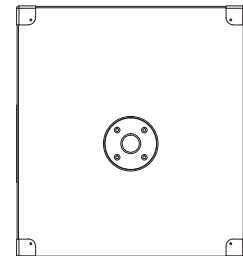

TOP

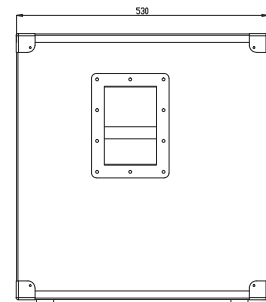

SIDE

SPL / IMPEDANCE VS FREQ.

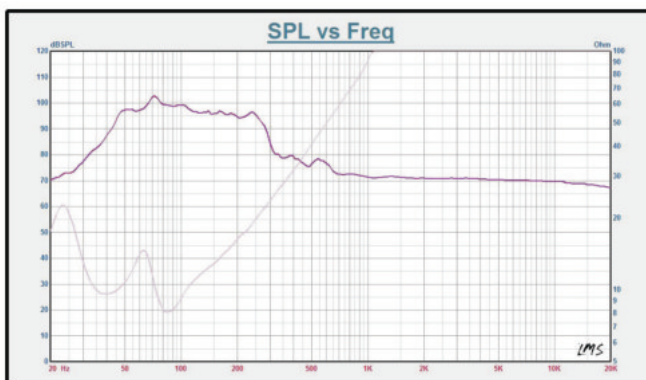

METIS-18S | HIGH POWER PASSIVE SUBWOOFER SYSTEM



The METIS Series were designed to provide stellar professional sound but still in competitive prices. It will be your best choice combines performance and value to get the Sound Town METIS series, which stacks up with high efficient loudspeakers, titanium compression drivers and impressive power handling.

METIS family consists of full range single 12", 15", dual 12", dual 15"; 10", 12", 15" floor monitor and 15", 18" high power subwoofer are available in both passive and self-powered version. There is also a 21" super subwoofer can provided roof overturned bass.

Thanks to Sound Town NIX series premium amplifier, there are also several METIS package on choice which can help users to set up their PA system conveniently and deliver professional quality sound.

SPECIFICATIONS

SYSTEM DATA:

FREQUENCY RESPONSE: 38 Hz - 350Hz
 SENSITIVITY: 97 db (Passive)
 SPL MAX: 124 db

DISPERSION:

LOUDSPEAKER DATA:

CONFIGURATION: 18" Passive subwoofer system
 TRANSDUCER: LF: 1 x 18" (w/ 4" voice coil)
 IMPEDANCE: 8Ω Nominal
 POWER HANDLING: 500 / 1000W
 CONNECTORS: 2 x 4 Pin Speakon®, 2 x 1/4" Jack

PHYSICAL:

CABINET CONSTRUCTION: Particle board, plywood reinforced
 MOUNTING: Stand mount on top
 FINISH: Carpeting

GRILL AND RIGGING COMPONENTS: Steel with anti-corrosion coat

DIMENSIONS (MM / INCH): 560 W - 605 D - 635 H / 22 W - 23.8 D - 25 H
 WEIGHT: 27.5 kg / 60.6 lb

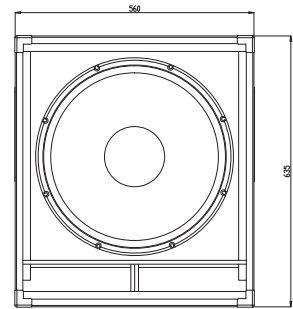

FRONT

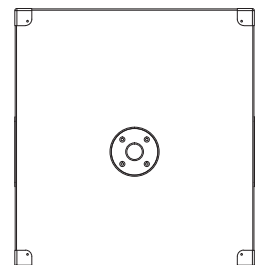

TOP

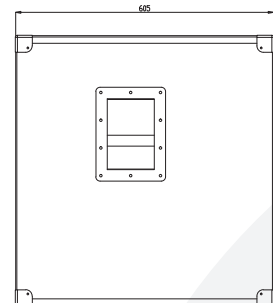

SIDE

SPL / IMPEDANCE VS FREQ.

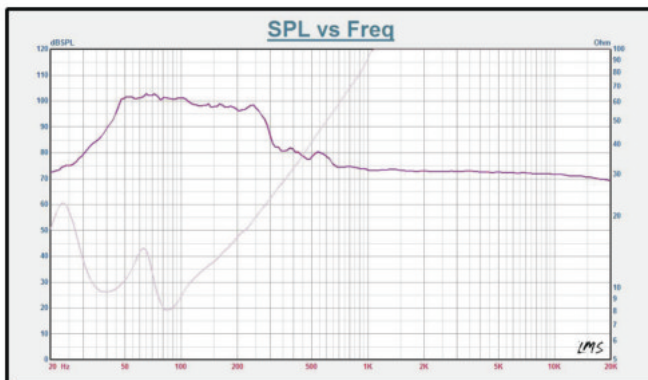

METIS-18SPW

HIGH POWER ACTIVE
SUBWOOFER SYSTEM



The METIS Series were designed to provide stellar professional sound but still in competitive prices. It will be your best choice combines performance and value to get the Sound Town METIS series, which stacks up with high efficient loudspeakers, titanium compression drivers and impressive power handling.

METIS family consists of full range single 12", 15", dual 12", dual 15"; 10", 12", 15" floor monitor and 15", 18" high power subwoofer are available in both passive and self-powered version. There is also a 21" super subwoofer can provided roof overturned bass.

Thanks to Sound Town NIX series premium amplifier, there are also several METIS package on choice which can help users to set up their PA system conveniently and deliver professional quality sound.

SPECIFICATIONS

SYSTEM DATA:

FREQUENCY RESPONSE: 38 Hz - 350Hz
 SENSITIVITY: 97 db (Passive)
 SPL MAX: 124 db
 DISPERSION: N/A

LOUDSPEAKER DATA:

CONFIGURATION: 18" High power active subwoofer
 TRANSDUCER: 1 x 18" (w/ 4" voice coil)
 IMPEDANCE: 8Ω Nominal
 POWER HANDLING: 500 / 1000W

PHYSICAL:

CABINET CONSTRUCTION: Particle board, plywood reinforced
 MOUNTING: Stand mount on top
 FINISH: Carpeting
 GRILL AND RIGGING COMPONENTS: Steel with anti-corrosion coat
 DIMENSIONS (MM / INCH): 560 W - 605 D - 635 H / 22 W - 23.8 D - 25 H
 WEIGHT: 35.5 kg / 78.3 lb

AMPLIFIER:

TYPE: Class AB
 T.H.D: 0.5% (1kHz -9db)
 LOAD CAPACITY: 8Ω / 4Ω
 INPUT IMPEDANCE: 1.2V / 20KΩ
 CONNECTOR: 2 x XLR female & 1/4" combo with 2 x XLR male loop out, RCA
 CONTROL: Master volume, LF extension, LPF, Polarity, LED on / off
 VOLTAGE SELECTION: 100-240V AC, 50 / 60Hz

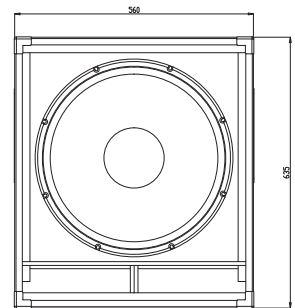

FRONT

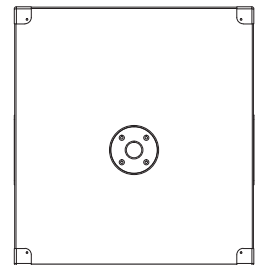

TOP

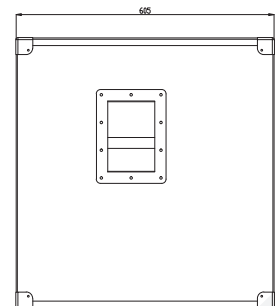

SIDE

SPL / IMPEDANCE VS FREQ.

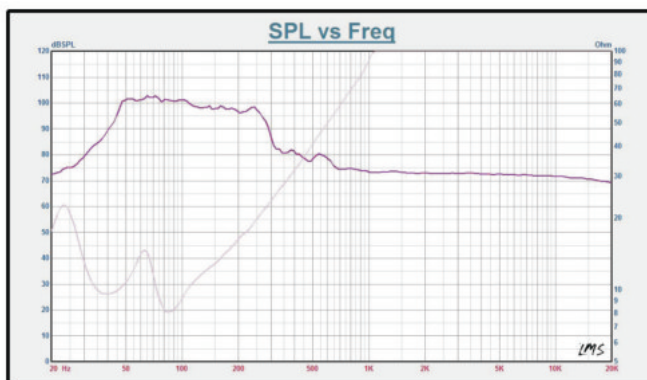

METIS-21S | HIGH POWER PASSIVE SUBWOOFER SYSTEM



The METIS Series were designed to provide stellar professional sound but still in competitive prices. It will be your best choice combines performance and value to get the Sound Town METIS series, which stacks up with high efficient loudspeakers, titanium compression drivers and impressive power handling.

METIS family consists of full range single 12", 15", dual 12", dual 15"; 10", 12", 15" floor monitor and 15", 18" high power subwoofer are available in both passive and self-powered version. There is also a 21" super subwoofer can provided roof overturned bass.

Thanks to Sound Town NIX series premium amplifier, there are also several METIS package on choice which can help users to set up their PA system conveniently and deliver professional quality sound.

SPECIFICATIONS

SYSTEM DATA:

FREQUENCY RESPONSE: 35 Hz - 350Hz
 SENSITIVITY: 99 db (Passive)
 SPL MAX: 128 db

DISPERSION:

LOUDSPEAKER DATA:

CONFIGURATION: 21" Passive subwoofer system
 TRANSDUCER: LF: 1 x 21" (w/ 4" voice coil)
 IMPEDANCE: 8Ω Nominal
 POWER HANDLING: 800 / 1600W
 CONNECTORS: 2 x 4 Pin Speakon®, 2 x 1/4" Jack

PHYSICAL:

CABINET CONSTRUCTION: Plywood
 MOUNTING: Stand mount on top & side
 FINISH: Carpeting
 GRILL AND RIGGING COMPONENTS: Steel with anti-corrosion coat
 DIMENSIONS (MM / INCH): 812 W - 609 D - 609 H / 32 W - 24 D - 24 H
 WEIGHT: 52 kg / 115 lb

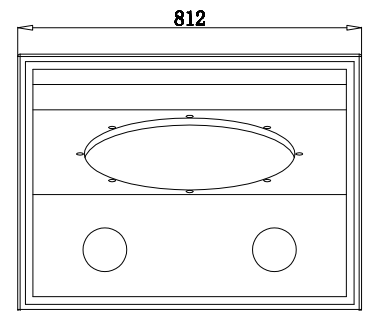

FRONT

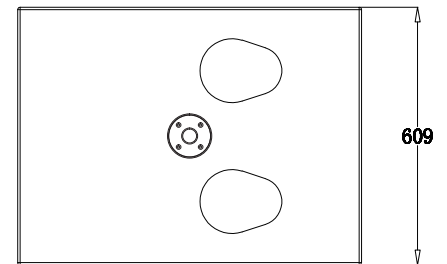

TOP

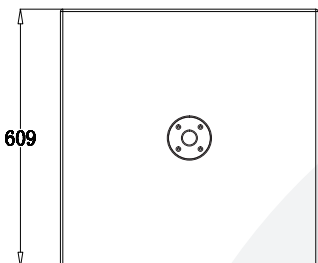

SIDE

SPL / IMPEDANCE VS FREQ.

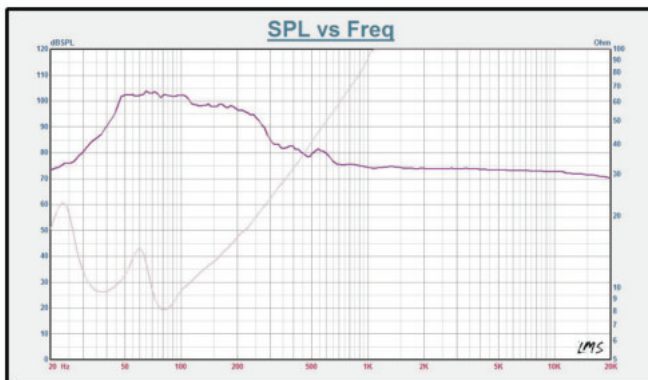

METIS-10M | PROFESSIONAL TWO-WAY FLOOR MONITOR



The METIS Series were designed to provide stellar professional sound but still in competitive prices. It will be your best choice combines performance and value to get the Sound Town METIS series, which stacks up with high efficient loudspeakers, titanium compression drivers and impressive power handling.

METIS family consists of full range single 12", 15", dual 12", dual 15"; 10", 12", 15" floor monitor and 15", 18" high power subwoofer are available in both passive and self-powered version. There is also a 21" super subwoofer can provided roof overturned bass.

Thanks to Sound Town NIX series premium amplifier, there are also several METIS package on choice which can help users to set up their PA system conveniently and deliver professional quality sound.

SPECIFICATIONS

SYSTEM DATA:

FREQUENCY RESPONSE: 60 Hz - 20kHz

SENSITIVITY: 95 db (Passive)

SPL MAX: 121 db

DISPERSION: 105° x 60° (H x V)

LOUDSPEAKER DATA:

CONFIGURATION: 10" 2-way floor monitor

TRANSDUCER: LF: 1 x 10", HF: 1 x 1" compression driver

IMPEDANCE: 8Ω Nominal

POWER HANDLING: 150 / 300W

CONNECTORS: 1 x 4 Pin Speakon®, 2 x 1/4" Jack

PHYSICAL:

CABINET CONSTRUCTION: Particle board

MOUNTING:

FINISH: Carpeting

GRILL AND RIGGING COMPONENTS: Steel with anti-corrosion coat

DIMENSIONS (MM / INCH): 485 W - 320 D - 273 H / 19.1 W - 12.6 D - 10.7 H

WEIGHT: 11 kg / 24.3 lb

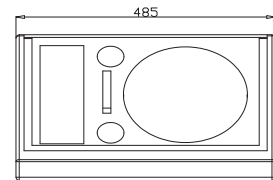

FRONT

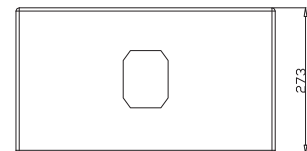

BACK

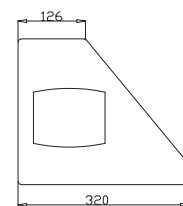

SIDE

SPL / IMPEDANCE VS FREQ.

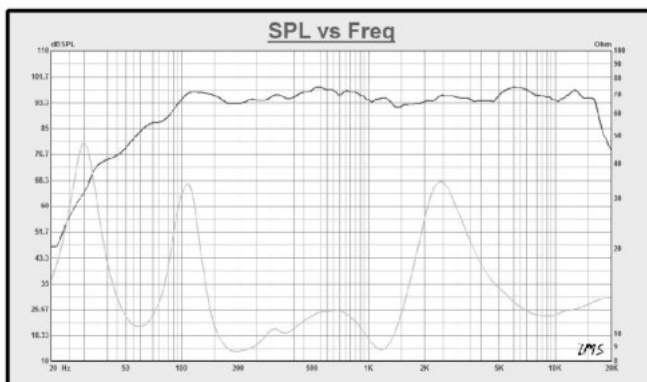

METIS-10MPW

PROFESSIONAL TWO-WAY
ACTIVE FLOOR MONITOR



The METIS Series were designed to provide stellar professional sound but still in competitive prices. It will be your best choice combines performance and value to get the Sound Town METIS series, which stacks up with high efficient loudspeakers, titanium compression drivers and impressive power handling.

METIS family consists of full range single 12", 15", dual 12", dual 15"; 10", 12", 15" floor monitor and 15", 18" high power subwoofer are available in both passive and self-powered version. There is also a 21" super subwoofer can provided roof overturned bass.

Thanks to Sound Town NIX series premium amplifier, there are also several METIS package on choice which can help users to set up their PA system conveniently and deliver professional quality sound.

SPECIFICATIONS

SYSTEM DATA:

FREQUENCY RESPONSE: 60 Hz - 20kHz
 SENSITIVITY: 95 db (Passive)
 SPL MAX: 121 db
 DISPERSION: 105° x 60° (H x V)

LOUDSPEAKER DATA:

CONFIGURATION: 10" Active 2-way floor monitor
 TRANSDUCER: LF: 1 x 10", HF: 1 x 1" compression driver
 IMPEDANCE: 8Ω Nominal
 POWER HANDLING: 150 / 300W

PHYSICAL:

CABINET CONSTRUCTION: Particle board
 MOUNTING:
 FINISH: Carpeting

GRILL AND RIGGING COMPONENTS: Steel with anti-corrosion coat

DIMENSIONS (MM / INCH): 485 W - 320 D - 273 H / 19,1 W - 12,6 D - 10,7 H
 WEIGHT: 22 kg / 48,5 lb

AMPLIFIER:

TYPE: Class AB
 T.H.D: 0.5% (1kHz -9db)
 LOAD CAPACITY: 8Ω / 4Ω
 INPUT IMPEDANCE: 1.2V / 20KΩ
 CONNECTOR: XLR female & 1/4" combo with XLR male loop out, RCA, 1/8" mp3
 CONTROL: Master volume
 VOLTAGE SELECTION: 100-240V AC, 50 / 60Hz

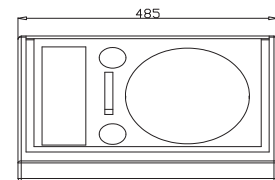

FRONT

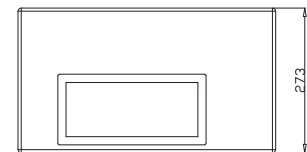

BACK

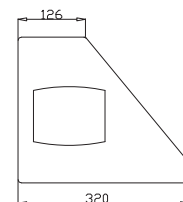

SIDE

SPL / IMPEDANCE VS FREQ.

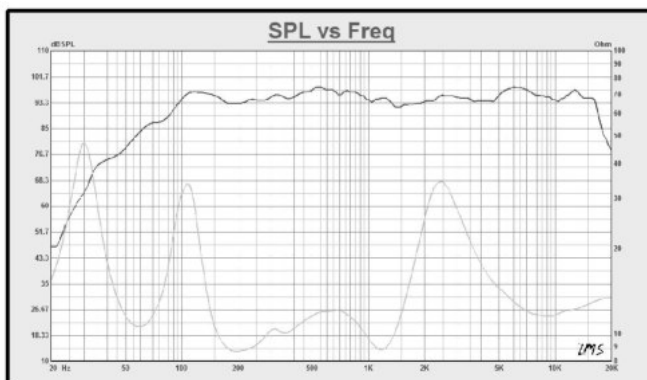

METIS-12M

PROFESSIONAL TWO-WAY FLOOR MONITOR



The METIS Series were designed to provide stellar professional sound but still in competitive prices. It will be your best choice combines performance and value to get the Sound Town METIS series, which stacks up with high efficient loudspeakers, titanium compression drivers and impressive power handling.

METIS family consists of full range single 12", 15", dual 12", dual 15"; 10", 12", 15" floor monitor and 15", 18" high power subwoofer are available in both passive and self-powered version. There is also a 21" super subwoofer can provided roof overturned bass.

Thanks to Sound Town NIX series premium amplifier, there are also several METIS package on choice which can help users to set up their PA system conveniently and deliver professional quality sound.

SPECIFICATIONS

SYSTEM DATA:

FREQUENCY RESPONSE: 55 Hz - 20kHz

SENSITIVITY: 96 db (Passive)

SPL MAX: 122 db

DISPERSION: 105° x 60° (H x V)

LOUDSPEAKER DATA:

CONFIGURATION: 12" 2-way floor monitor

TRANSDUCER: LF: 1 x 12", HF: 1 x 1" compression driver

IMPEDANCE: 8Ω Nominal

POWER HANDLING: 250 / 500W

CONNECTORS: 1 x 4 Pin Speakon®, 2 x 1/4" Jack

PHYSICAL:

CABINET CONSTRUCTION: Particle board

MOUNTING:

FINISH: Carpeting

GRILL AND RIGGING COMPONENTS: Steel with anti-corrosion coat

DIMENSIONS (MM / INCH): 525 W - 380 D - 315 H / 20.7 W - 15 D - 12.4 H

WEIGHT: 12 kg / 26.5 lb

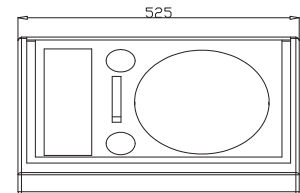

FRONT

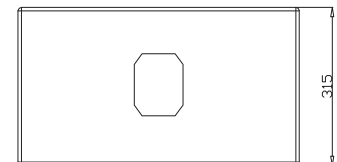

BACK

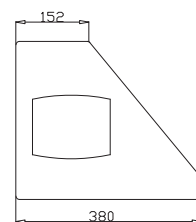

SIDE

SPL / IMPEDANCE VS FREQ.

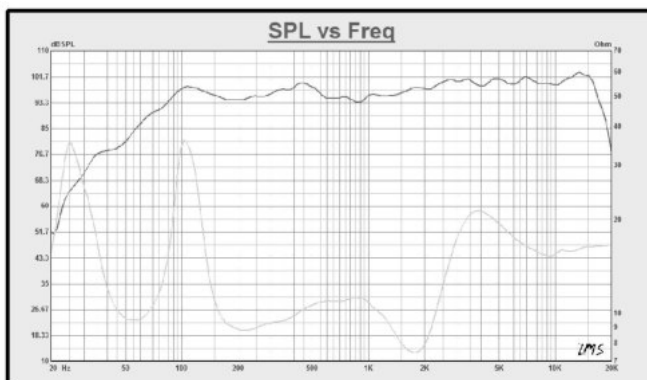

METIS-1 2MPW

PROFESSIONAL TWO-WAY
ACTIVE FLOOR MONITOR



The METIS Series were designed to provide stellar professional sound but still in competitive prices. It will be your best choice combines performance and value to get the Sound Town METIS series, which stacks up with high efficient loudspeakers, titanium compression drivers and impressive power handling.

METIS family consists of full range single 12", 15", dual 12", dual 15"; 10", 12", 15" floor monitor and 15", 18" high power subwoofer are available in both passive and self-powered version. There is also a 21" super subwoofer can provided roof overturned bass.

Thanks to Sound Town NIX series premium amplifier, there are also several METIS package on choice which can help users to set up their PA system conveniently and deliver professional quality sound.

SPECIFICATIONS

SYSTEM DATA:

FREQUENCY RESPONSE: 55 Hz - 20kHz
 SENSITIVITY: 96 db (Passive)
 SPL MAX: 122 db
 DISPERSION: 105° x 60° (H x V)

LOUDSPEAKER DATA:

CONFIGURATION: 12" Active 2-way floor monitor
 TRANSDUCER: LF: 1 x 12", HF: 1 x 1" compression driver
 IMPEDANCE: 8Ω Nominal
 POWER HANDLING: 250 / 500W

PHYSICAL:

CABINET CONSTRUCTION: Particle board
 MOUNTING:
 FINISH: Carpeting

GRILL AND RIGGING COMPONENTS: Steel with anti-corrosion coat

DIMENSIONS (MM / INCH): 525 W - 380 D - 315 H / 20.7 W - 15 D - 12.4 H
 WEIGHT: 24 kg / 52.9 lb

AMPLIFIER:

TYPE: Class AB
 T.H.D: 0.5% (1kHz -9db)
 LOAD CAPACITY: 8Ω / 4Ω
 INPUT IMPEDANCE: 1.2V / 20KΩ
 CONNECTOR: XLR female & 1/4" combo with XLR male loop out, RCA, 1/8" mp3
 CONTROL: Master volume
 VOLTAGE SELECTION: 100-240V AC, 50 / 60Hz

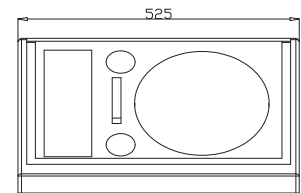

FRONT

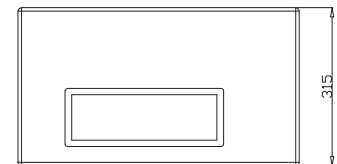

BACK

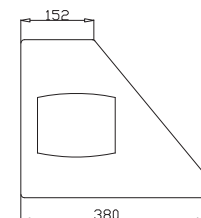

SIDE

SPL / IMPEDANCE VS FREQ.

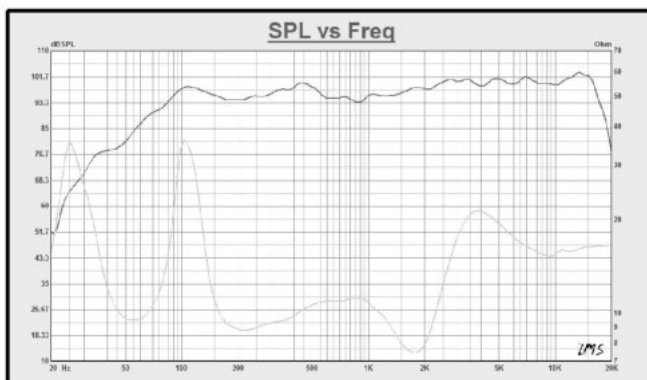

METIS-15M

PROFESSIONAL TWO-WAY
FLOOR MONITOR



The METIS Series were designed to provide stellar professional sound but still in competitive prices. It will be your best choice combines performance and value to get the Sound Town METIS series, which stacks up with high efficient loudspeakers, titanium compression drivers and impressive power handling.

METIS family consists of full range single 12", 15", dual 12", dual 15"; 10", 12", 15" floor monitor and 15", 18" high power subwoofer are available in both passive and self-powered version. There is also a 21" super subwoofer can provided roof overturned bass.

Thanks to Sound Town NIX series premium amplifier, there are also several METIS package on choice which can help users to set up their PA system conveniently and deliver professional quality sound.

SPECIFICATIONS

SYSTEM DATA:

FREQUENCY RESPONSE: 50 Hz - 20kHz

SENSITIVITY: 97 db (Passive)

SPL MAX: 124 db

DISPERSION: 105° x 60° (H x V)

LOUDSPEAKER DATA:

CONFIGURATION: 15" 2-way floor monitor

TRANSDUCER: LF: 1 x 15", HF: 1 x 1" compression driver

IMPEDANCE: 8Ω Nominal

POWER HANDLING: 300 / 600W

CONNECTORS: 1 x 4 Pin Speakon®, 2 x 1/4" Jack

PHYSICAL:

CABINET CONSTRUCTION: Particle board

MOUNTING:

FINISH: Carpeting

GRILL AND RIGGING COMPONENTS: Steel with anti-corrosion coat

DIMENSIONS (MM / INCH): 628 W - 475 D - 395 H / 24.7 W - 18.7 D - 15.6 H

WEIGHT: 17.1 kg / 37.8 lb

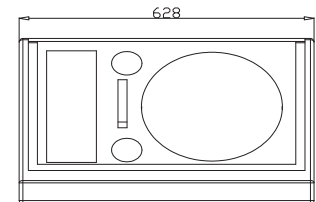

FRONT

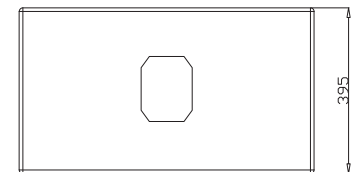

BACK

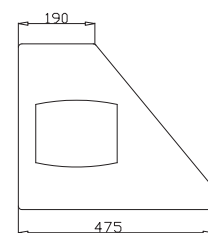

SIDE

SPL / IMPEDANCE VS FREQ.

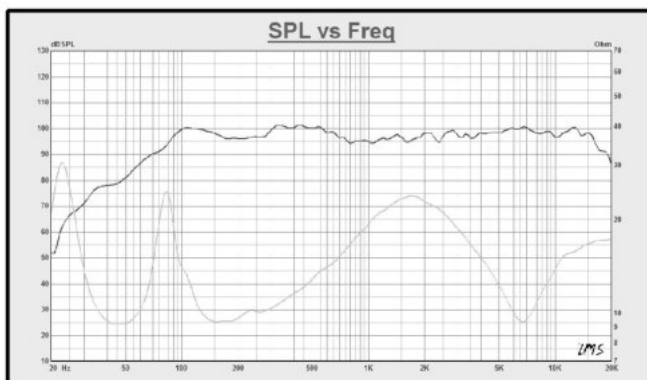

METIS-15MPW

PROFESSIONAL TWO-WAY
ACTIVE FLOOR MONITOR



The METIS Series were designed to provide stellar professional sound but still in competitive prices. It will be your best choice combines performance and value to get the Sound Town METIS series, which stacks up with high efficient loudspeakers, titanium compression drivers and impressive power handling.

METIS family consists of full range single 12", 15", dual 12", dual 15"; 10", 12", 15" floor monitor and 15", 18" high power subwoofer are available in both passive and self-powered version. There is also a 21" super subwoofer can provided roof overturned bass.

Thanks to Sound Town NIX series premium amplifier, there are also several METIS package on choice which can help users to set up their PA system conveniently and deliver professional quality sound.

SPECIFICATIONS

SYSTEM DATA:

FREQUENCY RESPONSE: 50 Hz - 20kHz
 SENSITIVITY: 97 db (Passive)
 SPL MAX: 124 db
 DISPERSION: 105° x 60° (H x V)

LOUDSPEAKER DATA:

CONFIGURATION: 15" Active 2-way floor monitor
 TRANSDUCER: LF: 1 x 15", HF: 1 x 1" compression driver
 IMPEDANCE: 8Ω Nominal
 POWER HANDLING: 300 / 600W

PHYSICAL:

CABINET CONSTRUCTION: Particle board
 MOUNTING:
 FINISH: Carpeting

GRILL AND RIGGING COMPONENTS: Steel with anti-corrosion coat

DIMENSIONS (MM / INCH): 628 W - 475 D - 395 H / 24.7 W - 18.7 D - 15.6 H
 WEIGHT: 27 kg / 59.5 lb

AMPLIFIER:

TYPE: Class AB
 T.H.D: 0.5% (1kHz -9db)
 LOAD CAPACITY: 8Ω / 4Ω
 INPUT IMPEDANCE: 1.2V / 20KΩ
 CONNECTOR: XLR female & 1/4" combo with XLR male loop out, RCA, 1/8" mp3
 CONTROL: Master volume
 VOLTAGE SELECTION: 100-240V AC, 50 / 60Hz

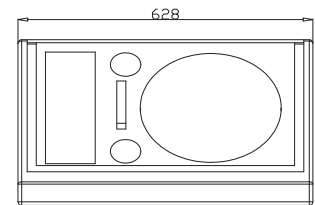

FRONT

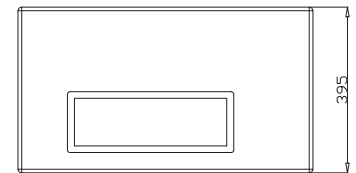

BACK

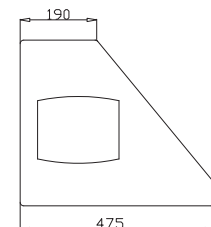

SIDE

SPL / IMPEDANCE VS FREQ.

