

FORTWY

Products & Projects



FORTVNY®

An extraordinary cultural project reviving the elegance of early 20th century tastes in the design of lamps.

From silk to glass, the collection express multiple aesthetic and functional needs, adapting to both modern and classic interiors.

Sophistication, refined techniques, a high quality finish and attention to detail are the distinctive features of each original lamp bearing the FORTVNY® trademark.

FORTUNY® SILK LAMPS

SCHEHERAZADE

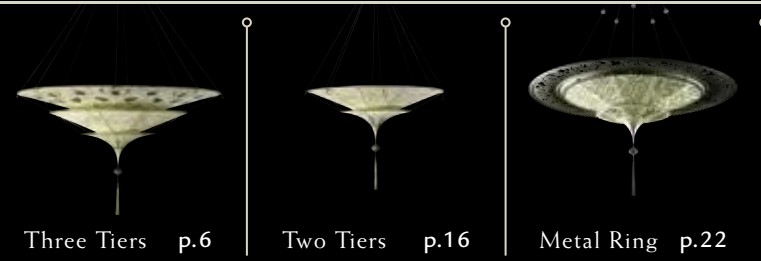

SCUDO SARACENO



SAMARKANDA



CESENDELLO

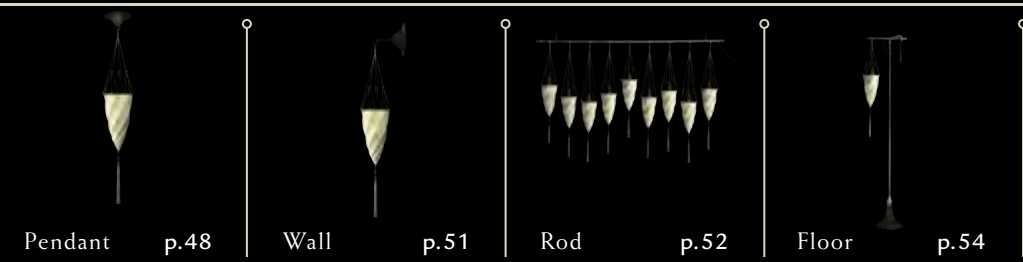

CONCUBINE



FORTUNY® GLASS LAMPS

SCHEHERAZADE



SCUDO SARACENO

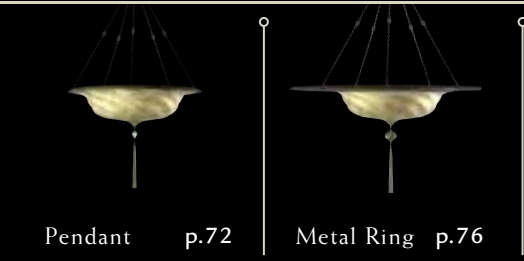

SAMARKANDA



CESENDELLO

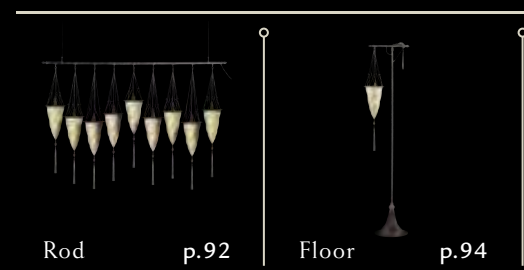
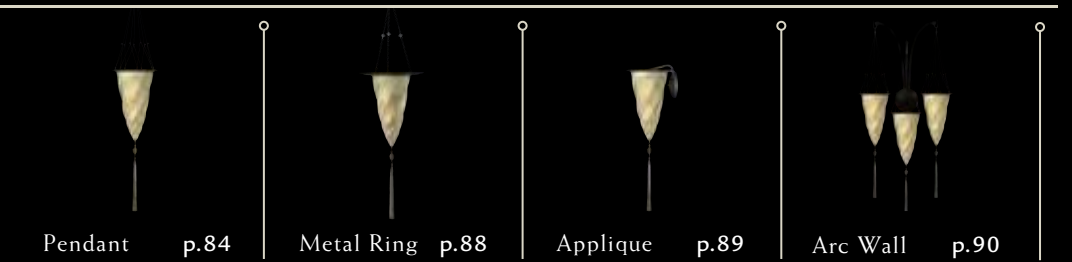

COMPOSITIONS

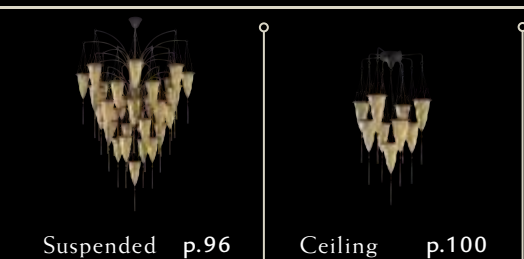



SILK LAMPS

The lightness of the opaline silk, the refined decoration and the balance of the silhouettes merge together, creating true sculptures of light.

Perpetuating the tradition, Fortuny continues to produce these wonderful lamps.

Evoking almost fairytale places and times, FORTUNY® lamps are the result of research into lighting, design and ways of filtering light.

Thanks to the particular structure and various models proposed, they fit in with any style of décor, completely satisfying the needs of good illumination and giving the space a soft, evocative and timeless atmosphere.



Photo: Julie Soefer . Interior Design: Slovack-Bass

SCHEHERAZADE

This lamp's name reflects the atmosphere it creates: a mixture of excitement and magnificence, along with intelligence and romance.

It combines Mariano Fortuny's love for Venetian and the Oriental cultures.

The elegant 3-tier structure has the form of an upside-down pagoda and is suspended by a delicate net of cords decorated with Murano glass beads.

The lower tier culminates with a fine engraved drop.





Photo: Phillip Ennis . Interior Design: Slovack-Bass



Photo: Julie Soefer . Interior Design: Slovack-Bass



Photo: Ken Seet . Project: Four Seasons Resort Dubai at Jumeirach Beach



Photo: Casey Dunn . Interior Design: Risinger & Co.



Interior Design: Abby Smith Design



Art. 126 SH

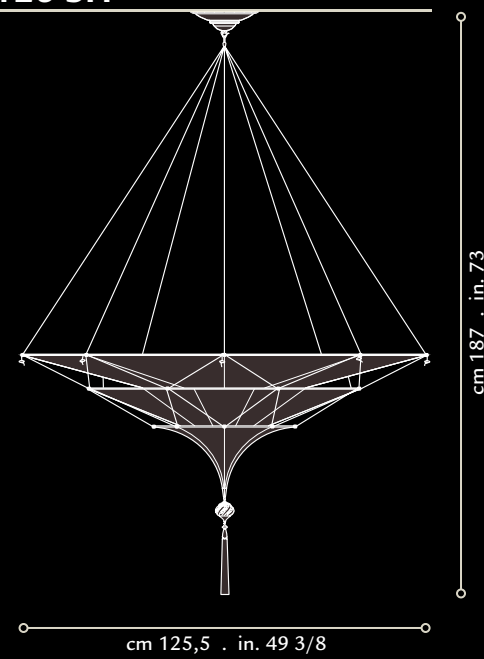

Structure: brass
 Shade: pure silk fabric, murano glass beads
 Weight: kg 4,4 . lb.9 oz.11
 Wattage: suspended version 4 x max100W
 flush mounted version 1 x max100W
 Voltage: E26 socket 110V . E27 socket 220/240V
 also suitable for LED light bulbs



Geometric



Floral



Herbarium



Plain





SCHEHERAZADE 2 TIERS

A lamp with an evocative name conjuring up the magnificence of the Orient.

In the two tiers Scheherazade, Oriental style elements combine with Venetian-Saracen decorative motifs.

The lower tier culminates with a fine engraved drop.



Photo: Durston Saylor . Interior Design: David Scott Parker Architects

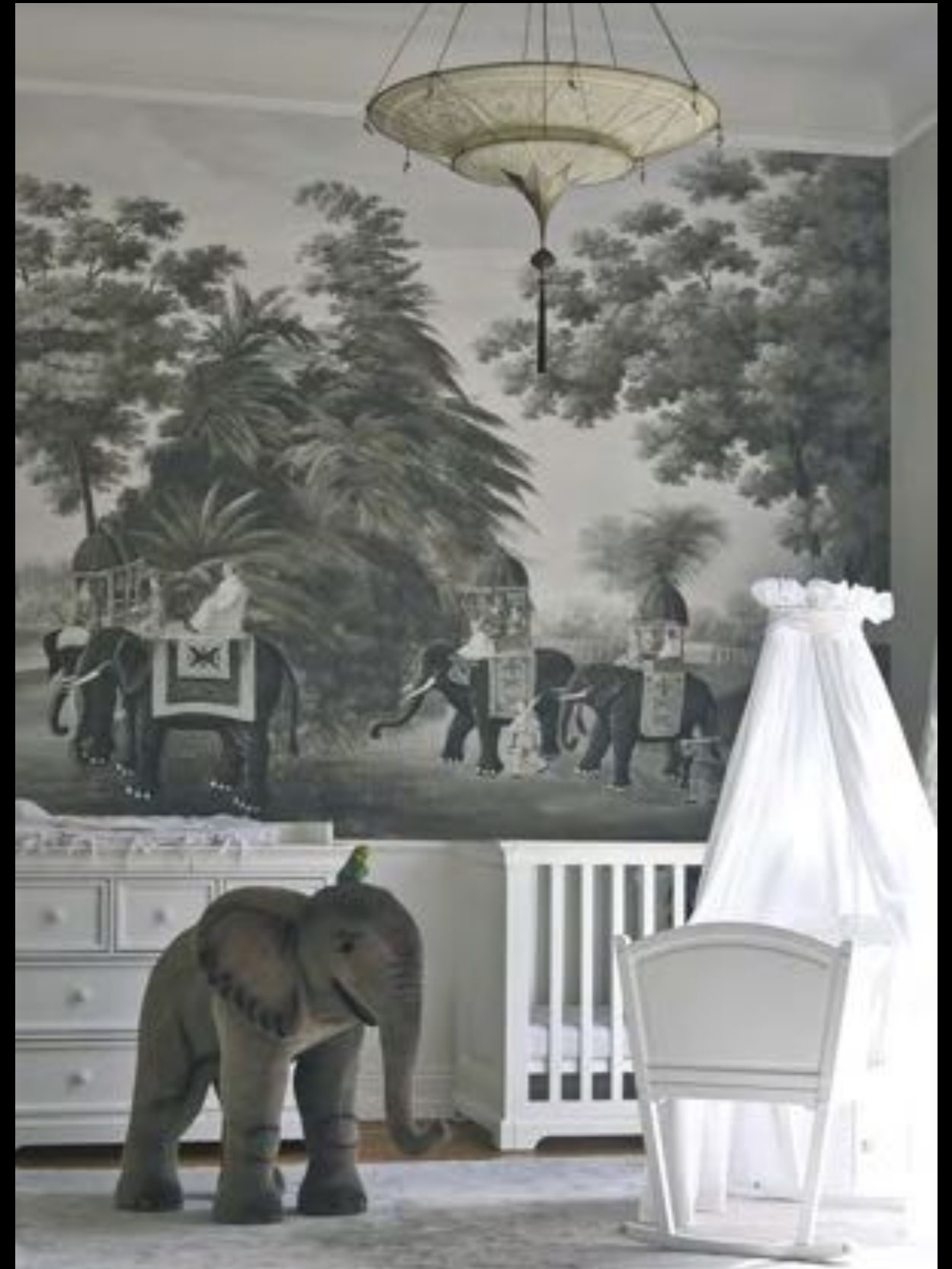

Interior Design: Julia Rafflenbeul



Art. 086 SH

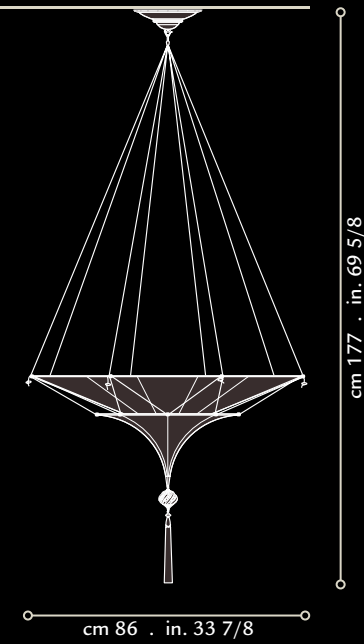

Structure: brass
 Shade: pure silk fabric, murano glass beads
 Weight: kg 2,2 . lb.4 oz.14
 Wattage: suspended version 1 x max100W
 flush mounted version 1 x max100W
 Voltage: 1xE26 socket 110V . 1xE27 socket 220/240V
 also suitable for LED light bulbs



Geometric



Floral



Herbarium



Plain





SCHEHERAZADE 2 TIERS
with metal ring

In the two tiers Scheherazade, Oriental style elements combine with Venetian-Saracen decorative motifs.

The lamp is ideal for large, sophisticated interiors. The light filters through the silk and penetrates the inlay of the decorative ring to create an evocative atmosphere.

The lower tier culminates with a fine engraved drop, and the Fortuny® trademark is engraved on the patterned metal ring.



**SCHEHERAZADE 2 TIERS
with metal ring**

Art. 125 SHC

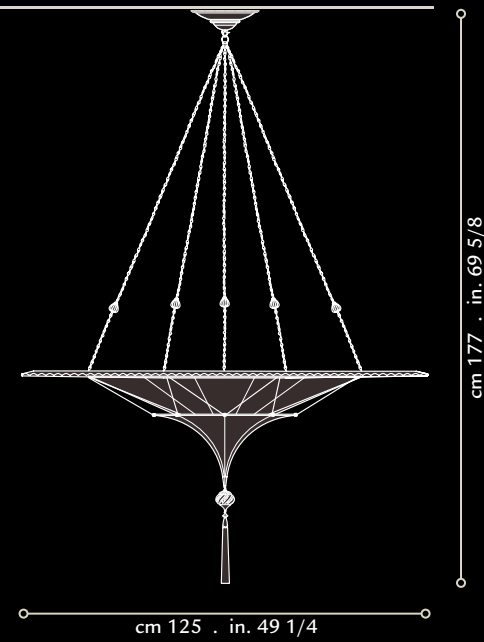

Structure: brass, burnished metal
 Shade: pure silk fabric, murano glass beads
 Weight: kg 9 . lb. 19 oz. 13
 Wattage: 3 x max 100W
 Voltage: 3xE26 socket 110V . 3xE27 socket 220/240V
 also suitable for LED light bulbs

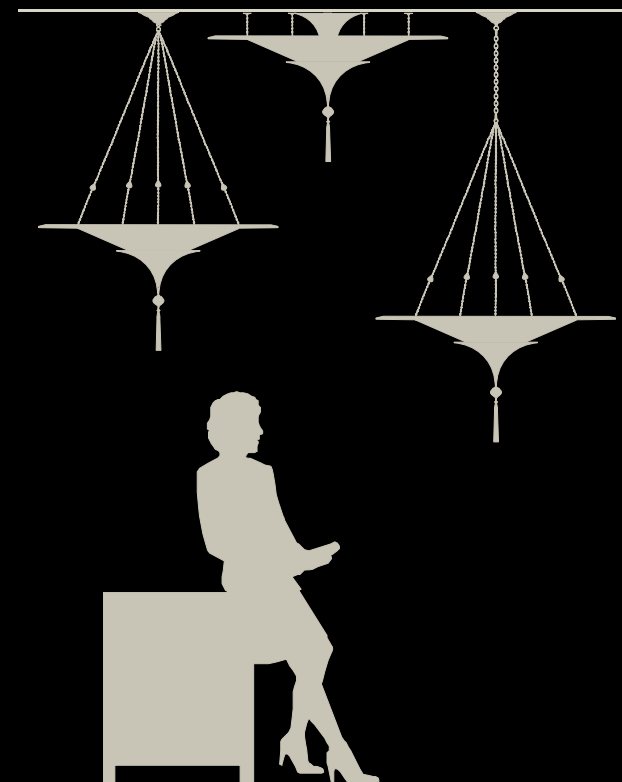

Geometric



Floral



Herbarium



Plain





Photo: Karen Melvin

SCUDO SARACENO

Scudo Saraceno translates to Saracen Shield. Saracen was a term used in medieval Europe to describe Muslims.

This exotic design reflects Mariano Fortuny's interest in Saracen artistic themes.

The shield-like shape, decorated with Ottoman motifs and the configuration of its sections starting out from the centre, create a wonderful "sun-like" effect.





Photo: Andreas Von Einsiedel



Project: Le Touessrok



Courtesy of Dark Lighting Instabul . Arch.: Atolye2A Alos Cavdar . Photo: Suat Ozcan



Photo: Giorgio Baroni . Interior Design: Alberto Pinto



Art. 050SA



Art. 062 SA

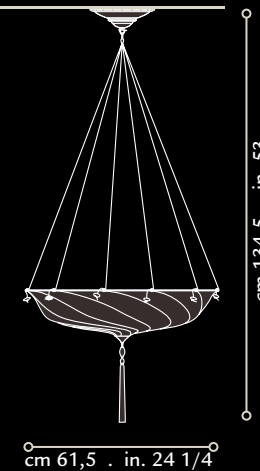

Art. 079 SA

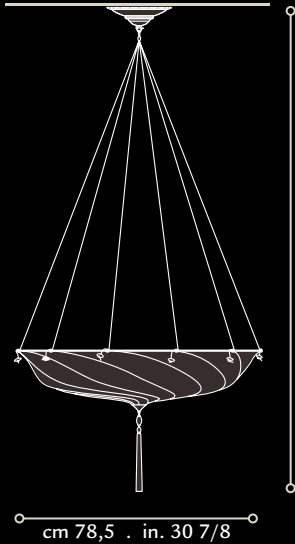

Structure: brass
 Shade: pure silk fabric, murano glass beads
 Weight: Ø50: kg 1,2 . lb.2 oz.10 Ø62: kg 1,5 . lb.3 oz.5
 Ø79: kg 2 . lb.4 oz.7
 Wattage: Ø50: 1 x max60W . Ø62: 1 x max75W
 Ø79: 1 x max75W
 Voltage: 1xE26 socket 110V . 1xE27 socket 220/240V
 also suitable for LED light bulbs



Ivory Classic



Ivory Serpentine



Ivory Plain



SCUDO SARACENO
with metal ring

Art. 084 SAC

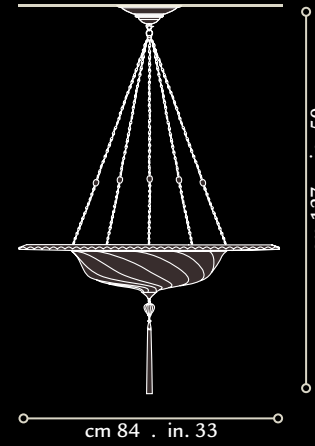

Art. 096 SAC

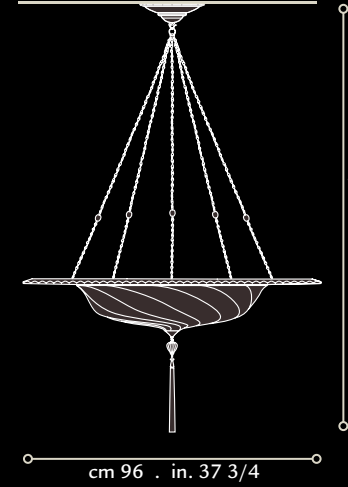

Structure: brass, burnished metal
 Shade: pure silk fabric, murano glass beads
 Weight: Ø84: kg 4,2 . lb.9 oz.4 Ø96: kg 6 . lb.13 oz.4
 Wattage: Ø84: 1 x max60W . Ø96: 1 x max75W
 Voltage: 1xE26 socket 110V . 1xE27 socket 220/240V
 also suitable for LED light bulbs

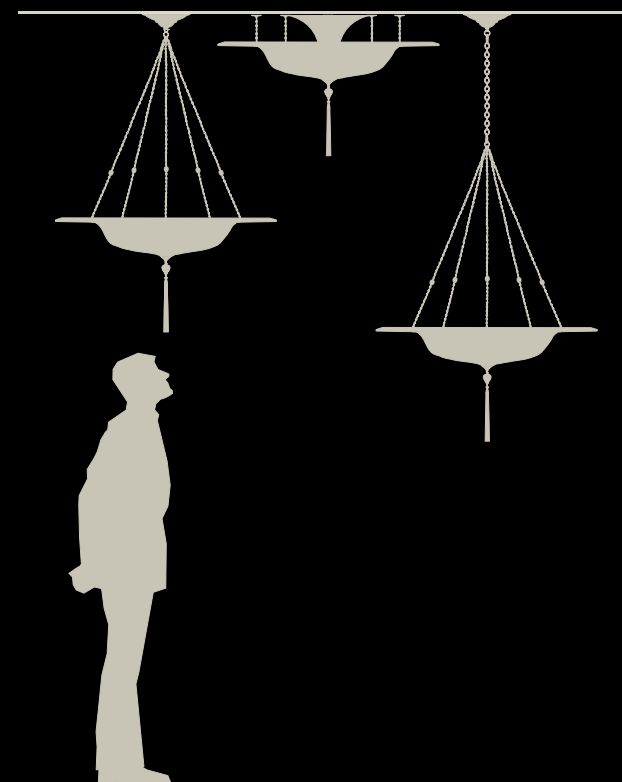

Ivory Classic



Ivory Serpentine



Ivory Plain





SAMARKANDA

Samarkand is a city in present day Uzbekistan, and lies on the famous Silk Road trade route linking Venice and China.

This lamp's unique shape and quintessential Fortuny pattern evoke the mystique of those ancient trade journeys, and the cultural fusion they sparked.

The metal ring adds an interesting contrast of delicacy and strength.



Serpentine

Art. 037 SK

Decò

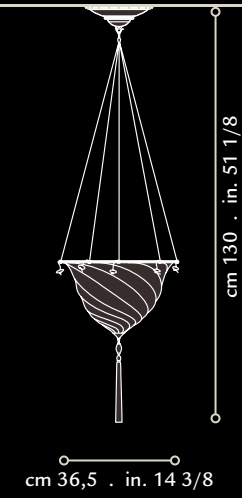

Structure: brass
 Shade: pure silk fabric, murano glass beads
 Weight: kg 1 . lb.2 oz.3
 Wattage: 1 x max60W
 Voltage: 1xE26 socket 110V
 1xE27 socket 220/240V
 also suitable for LED light bulbs



Plain





Serpentine

SAMARKANDA
with metal ring

Art. 069 SKC

Decò

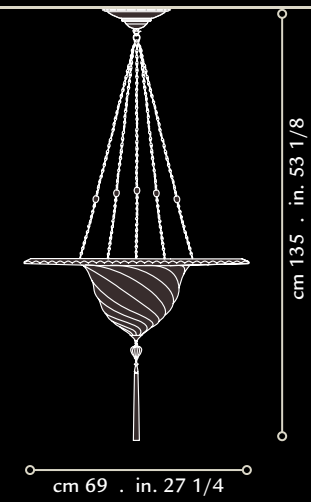

Structure: brass, burnished metal
 Shade: pure silk fabric, murano glass beads
 Weight: kg 2,9 . lb.6 oz.6
 Wattage: 1 x max60W
 Voltage: 1xE26 socket 110V
 1xE27 socket 220/240V
 also suitable for LED light bulbs

Plain

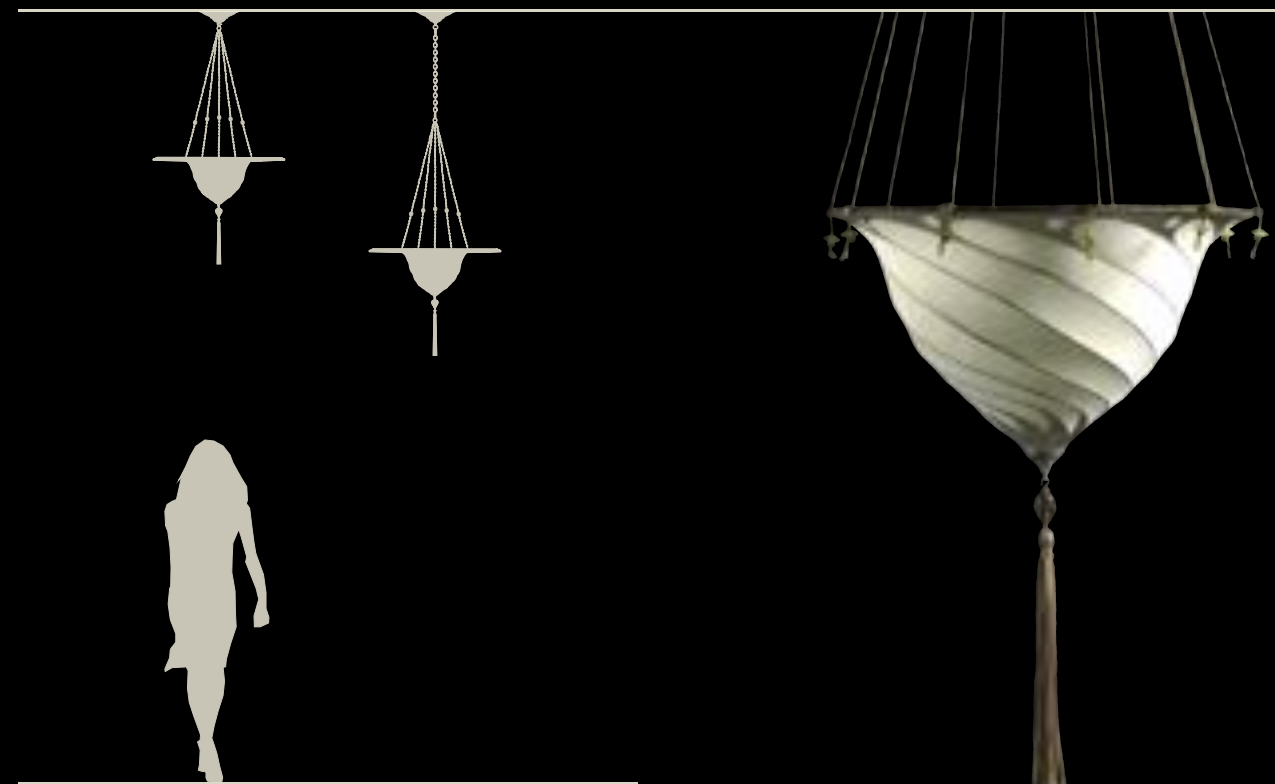



**SAMARKANDA
with disk**

It has a helmet-like structure, with spirals topped by an ornamental disc.

The disc is decorated with patterns suggesting a rose window in a Gothic cathedral.



SAMARKANDA
with disk

Art. 124 SD

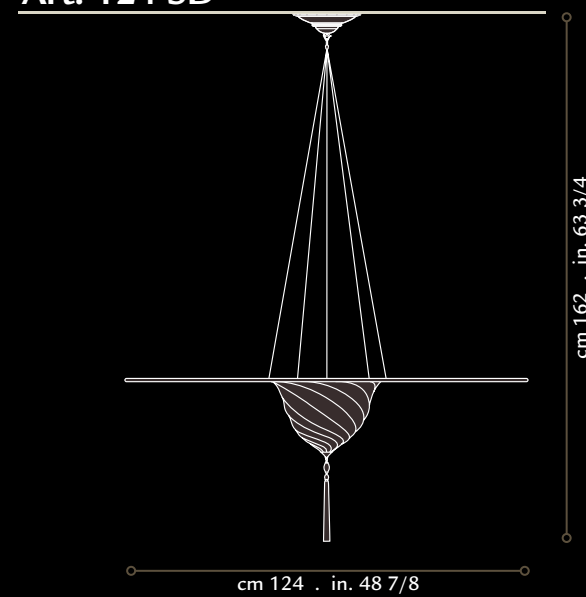

Structure: brass
 Shade: pure silk fabric, murano glass beads
 Weight: kg 2,5 . lb.5 oz.8
 Wattage: 1 x max75W
 Voltage: 1xE26 socket 110V
 1xE27 socket 220/240V
 also suitable for LED light bulbs

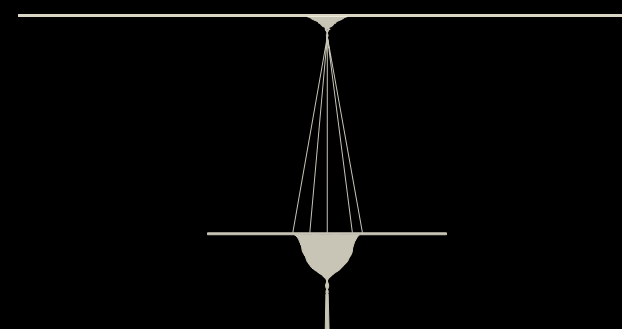

Decò



Plain



CESENDELLO

A cesendello, or sanctuary lamp, has its roots in Rome and Byzantium, and later became popular in Venice and the Muslim world.

The profile of this elegant spiral structure recalls the twist of a turban.

The refined silhouette represents the synthesis of the Oriental and Renaissance themes present in Venice as early as the 15th century.

Cesendello floor lamp design of Mariano Fortuny's was probably the first electric floor lamp.

The elegant Cesendello silhouette is enhanced by the fabric-covered stand, which has delightful inlays.



Art. 017 CE-1

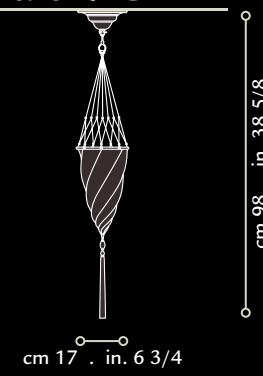

Art. 017 CE-2

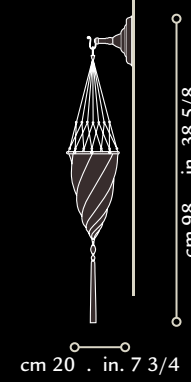

Structure: brass
Shade: pure silk fabric, murano glass beads
Weight: kg 0,7 . lb.1 oz.9
Wattage: 1 x max25W
Voltage: 1xE12 socket 110V
1xE14 socket 220/240V
also suitable for LED light bulbs

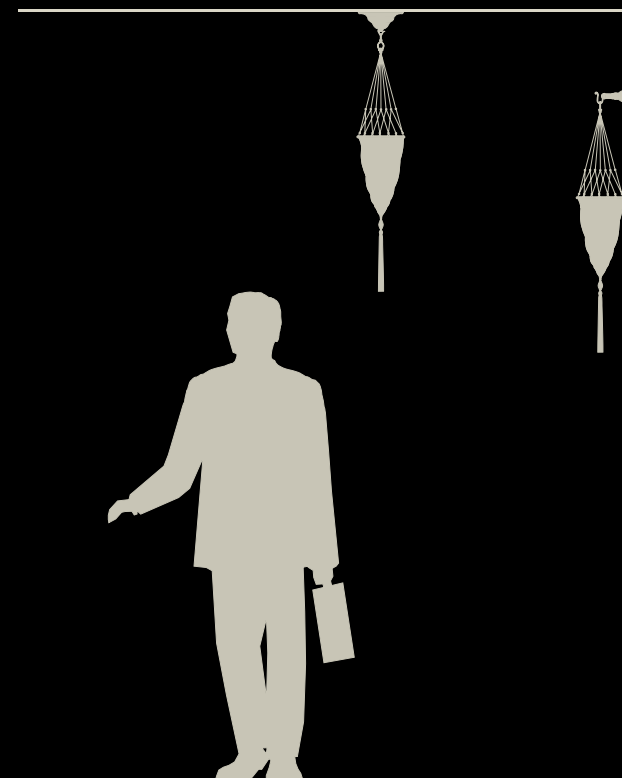

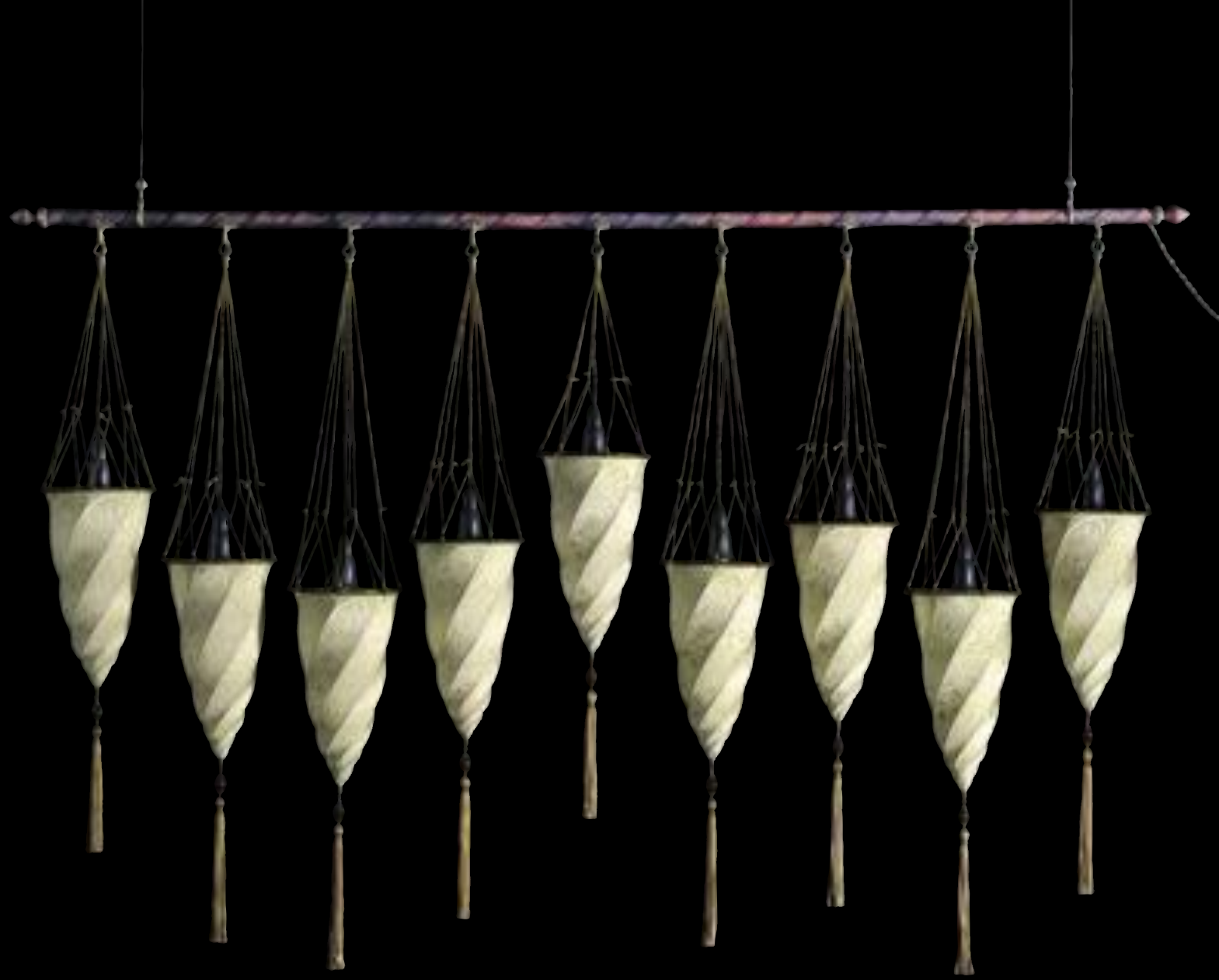

Art. AF 017-3

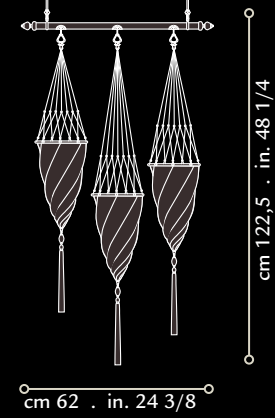

Art. AF 017-4

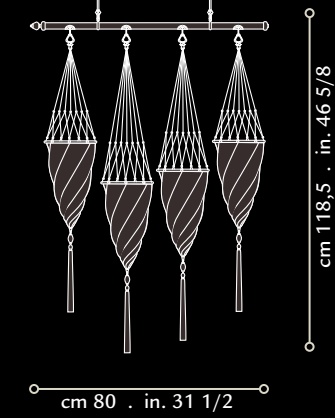

Art. AF 017-5

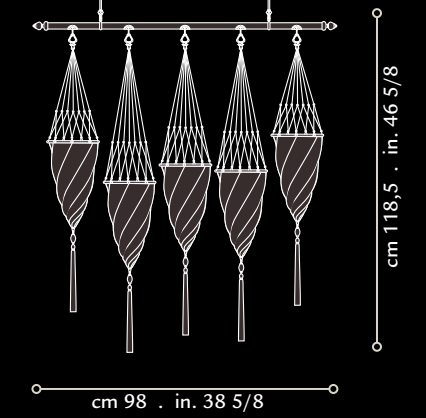

Art. AF 017-6

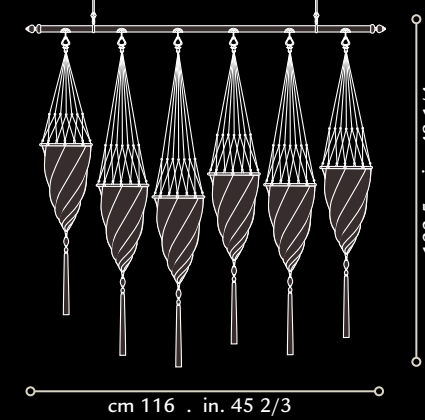

Art. AF 017-7

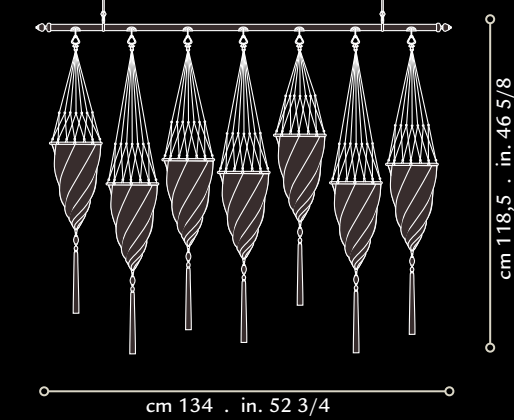

Art. AF 017-8

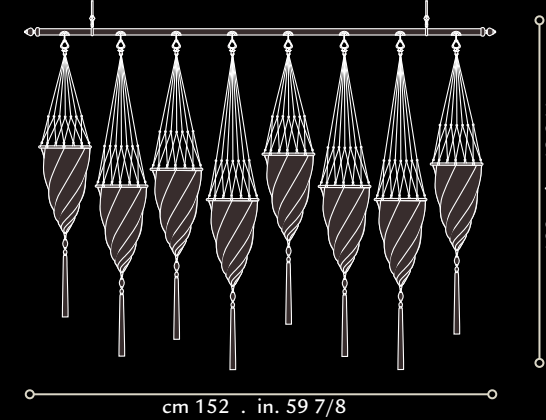

Art. AF 017-9

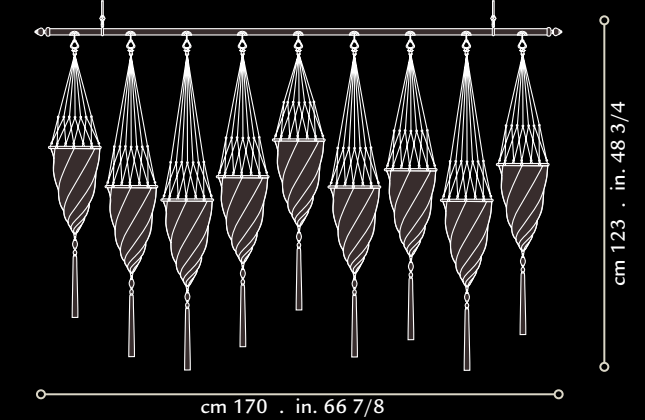

CESENDELLO
on a rod

Structure: brass
Shade: pure silk fabric, murano glass beads,
rod covered with fabric

Weight: kg 0,5 . lb.1 oz.2 (per shade)
Wattage: 1 x max25W(per shade)
Voltage: 1xE12 socket 110V . 1xE14 socket 220/240V
also suitable for LED light bulbs



red stand



green stand

CESENDELLO
floor lamp

Art. 174 ST

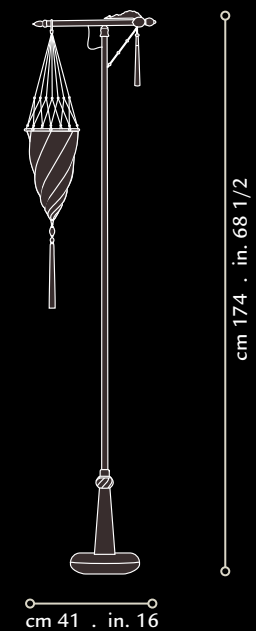

Structure: brass
Shade: pure silk fabric, murano glass beads,
stand covered with fabric
Base: cast iron
Base cover: velvet
Weight: kg 6,5 . lb. 14 oz. 5
Wattage: 1 x max 25W
Voltage: 1xE12 socket 110V
1xE14 socket 220/240V
also suitable for LED light bulbs

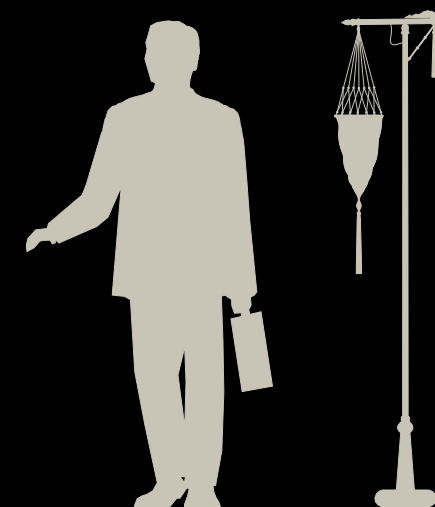



CESENDELLO LIBRA
floor lamp

Art. 200 ST

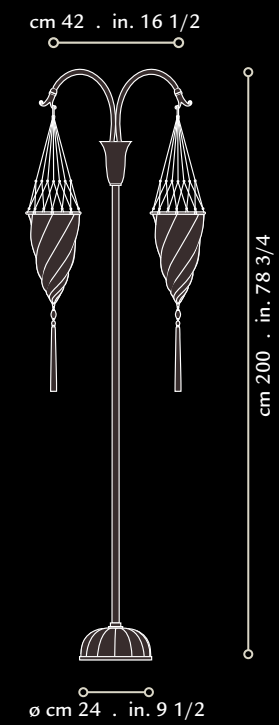

Structure: brass
Shade: pure silk fabric, murano glass beads,
stand covered with fabric
Base: brass
Weight: kg 12 . lb.26 oz.7
Wattage: 2 x max25W
Voltage: 2xE12 socket 110V
2xE14 socket 220/240V
also suitable for LED light bulbs

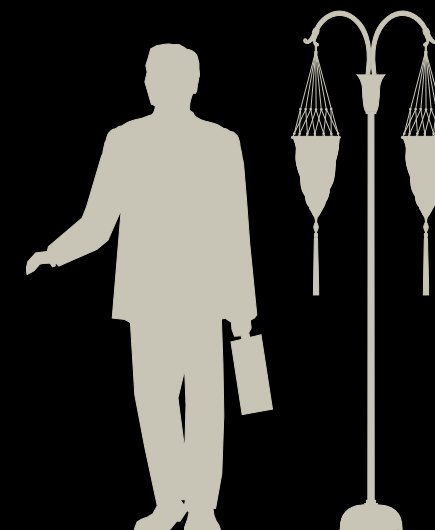



Photo: Jeff Herr

CONCUBINE

Concubina, evokes the allure of Oriental culture, which enthralled Mariano Fortuny.

The simple wood structure protects the silk and enhances its silvery patterns

Hang this lamp individually or in a composition to achieve soft lighting that adds refinement to any décor.





IMPERIALE

Art. 09 IMP

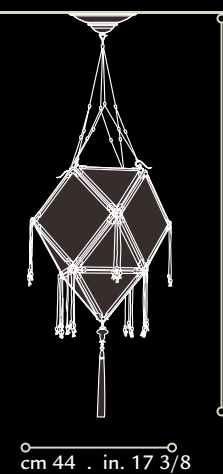

IMPERIALE



Structure: wood, brass, burnished metal
 Shade: pure silk fabric, murano glass beads
 Weight: kg 1,1 . lb.2 oz.7
 Wattage: 1 x max 75W
 Voltage: 1xE26 socket 110V
 1xE27 socket 220/240V
 also suitable for LED light bulbs

Art. 09 PRO



PROIBITA



Structure: wood, brass, burnished metal
 Shade: pure silk fabric, murano glass beads
 Weight: kg 1,5 . lb.3 oz.5
 Wattage: 1 x max 75W
 Voltage: 1xE26 socket 110V
 1xE27 socket 220/240V
 also suitable for LED light bulbs

Art. 09 FAV

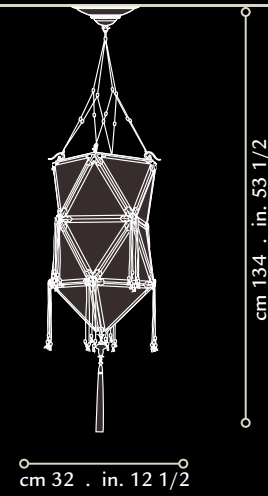

FAVORITA



Structure: wood, brass, burnished metal
 Shade: pure silk fabric, murano glass beads
 Weight: kg 1,2 . lb.2 oz.10
 Wattage: 1 x max 60W
 Voltage: 1xE12 socket 110V
 1xE14 socket 220/240V
 also suitable for LED light bulbs

Art. 09 TEM

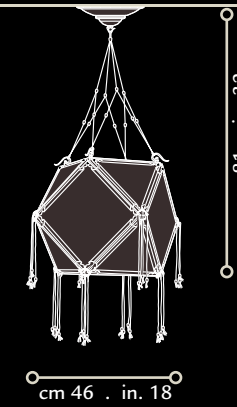

TEMPIO



Structure: wood, brass, burnished metal
 Shade: pure silk fabric, murano glass beads
 Weight: kg 0,9 . lb.1 oz.16
 Wattage: 1 x max 75W
 Voltage: 1xE26 socket 110V
 1xE27 socket 220/240V
 also suitable for LED light bulbs

Art. 09 PEO

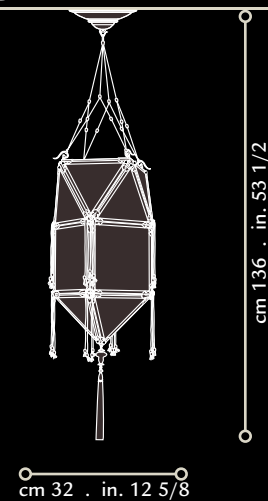

PEONIA



Structure: wood, brass, burnished metal
 Shade: pure silk fabric, murano glass beads
 Weight: kg 1,1 . lb.2 oz.7
 Wattage: 1 x max 60W
 Voltage: 1xE12 socket 110V
 1xE14 socket 220/240V
 also suitable for LED light bulbs

Art. 09 LOT

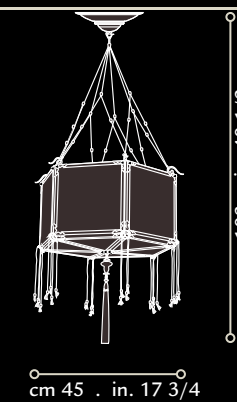

LOTO



Structure: wood, brass, burnished metal
 Shade: pure silk fabric, murano glass beads
 Weight: kg 0,9 . lb.1 oz.16
 Wattage: 1 x max 75W
 Voltage: 1xE26 socket 110V
 1xE27 socket 220/240V
 also suitable for LED light bulbs



GLASS LAMPS

In the glass range Fortuny continues the centuries-old tradition of the Venetian master glass blowers, while retaining the elegance and originality of the shapes found in the silk version.

The brilliance and transparency of the glass enhance the delicate gold decoration, made even more precious by the burnished metal of the decorative metal ring.

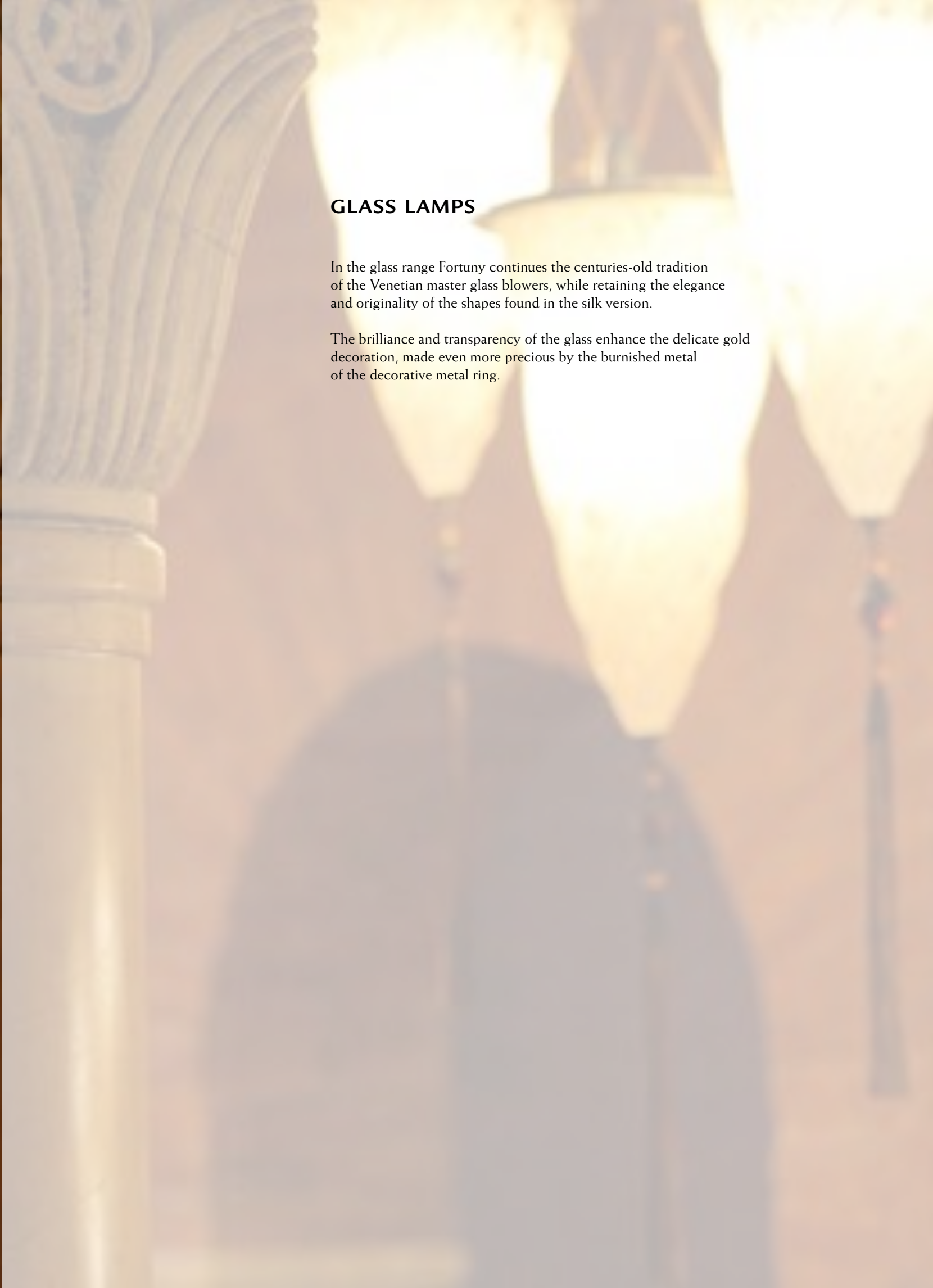



SCHEHERAZADE GLASS

This lamp's name reflects the atmosphere it creates: a mixture of excitement and magnificence, along with intelligence and romance. It combines Mariano Fortuny's love for Venetian and the Oriental cultures.

The elegant 3-tier structure has the form of an upside-down pagoda. The lower tier culminates with a fine engraved metal sphere and tassel.



Beige Geometric

Art. G 120 SH

Beige Geometric

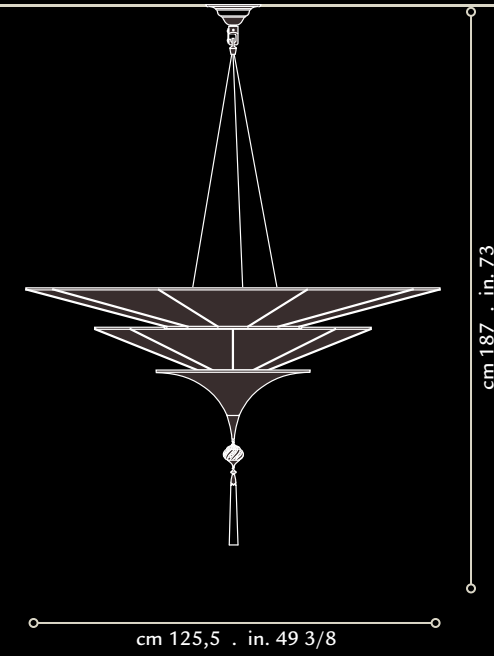

Structure: glass, brass, burnished metal,
murano glass beads
Weight: kg 32 . lb.70 oz.9
Wattage: 7 x max 15W LED
Voltage: 1xE26 socket 110V
1xE27 socket 220/240V



Red Floral



SCHEHERAZADE



Red Floral

Art. G 80 SH

Red Floral

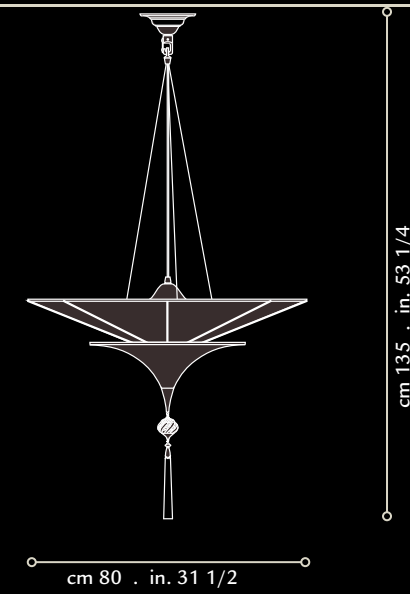

Structure: glass, brass, burnished metal,
 murano glass beads
 Weight: kg 20 . lb.44 oz.1
 Wattage: 6 x max15W LED + 1 x GU10 max 5W
 Voltage: 1xE26 socket 110V
 1xE27 socket 220/240V



Beige Geometric

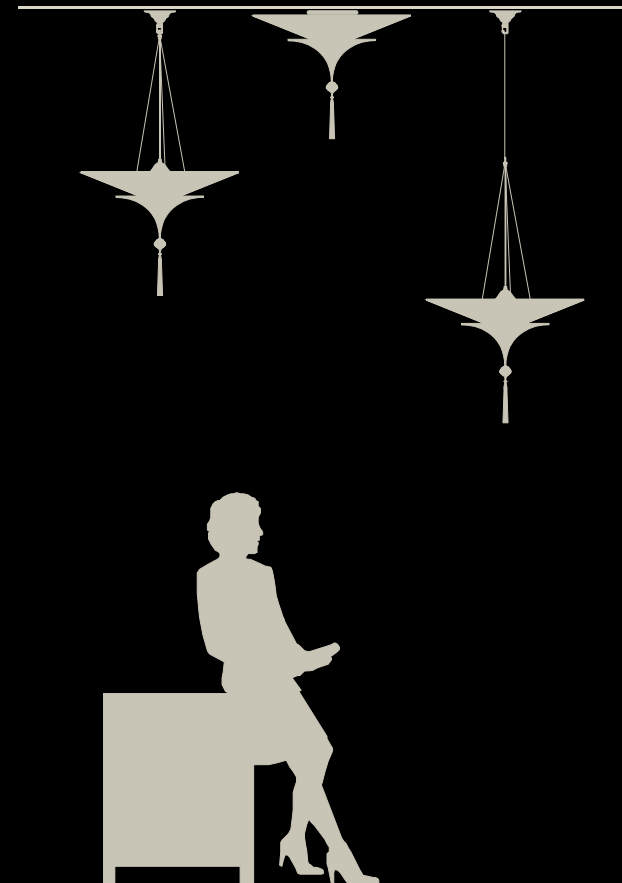

SCHEHERAZADE 2 TIERS



SCUDO SARACENO GLASS

Scudo Saraceno translates to Saracen Shield.
Saracen was a term used in medieval Europe to describe Muslims.

This exotic design reflects Mariano Fortuny's interest in Saracen artistic themes.

This lamp is ideal for large, sophisticated interiors.

Customise this lamp to suit your aesthetic, with choice of colour and pattern.



Gold Classic

Art. G055 SA

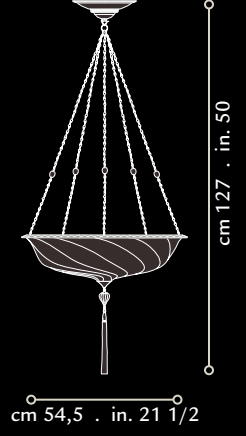

Art. G065 SA

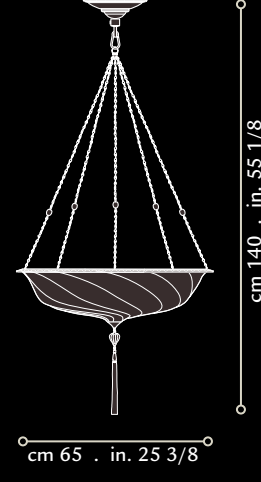

Art. G102 SA

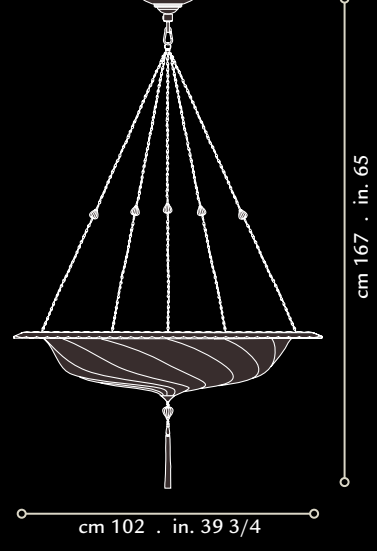

Structure: glass, brass, burnished metal, murano glass beads
 Weight: Ø55: kg 6 . lb.13 oz.4 Ø65: kg 9 . lb.19 oz.13
 Ø102: kg 18 . lb.39 oz.11
 Wattage: suspended: Ø55/ Ø65: 1 x max100W
 Ø102: 3 x max100W
 flush mounted: Ø55/ Ø65 3 x max40W
 Ø102: 3 x max100W
 Voltage: E26 socket 110V . E27 socket 220/240V
 also suitable for LED light bulbs

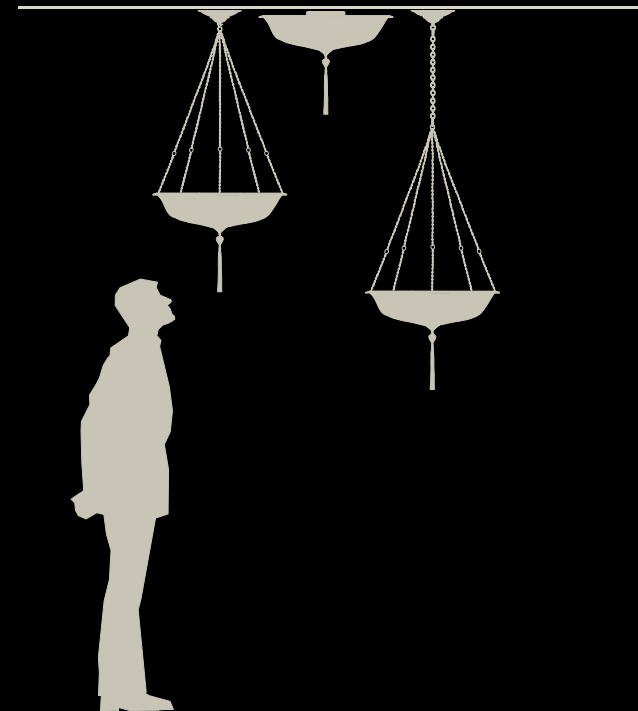

Silver Classic



White Classic



Gold Mosaic



Red Mosaic





Gold Classic

SCUDO SARACENO
with metal ring

Art. G084 SAC

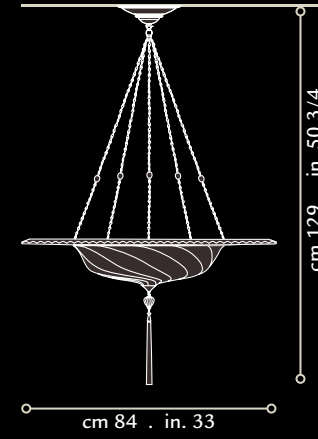

Art. G096 SAC

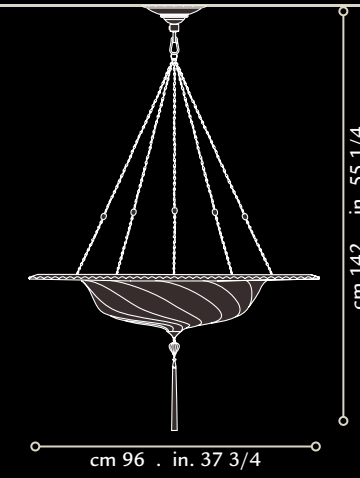

Art. G125 SGC

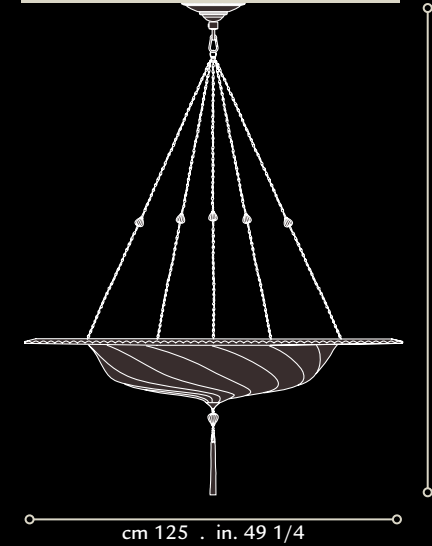

Structure: glass, brass, burnished metal, murano glass beads
 Weight: Ø84: kg 9,5 . lb.20 oz.15 Ø96: kg 11,5 . lb.25 oz.6
 Ø125: kg 22 . lb.48 oz.8
 Wattage: Ø84: 1 x max100W . Ø96: 1 x max100W
 Ø125: 3 x max100W
 Voltage: E26 socket 110V . E27 socket 220/240V
 also suitable for LED light bulbs

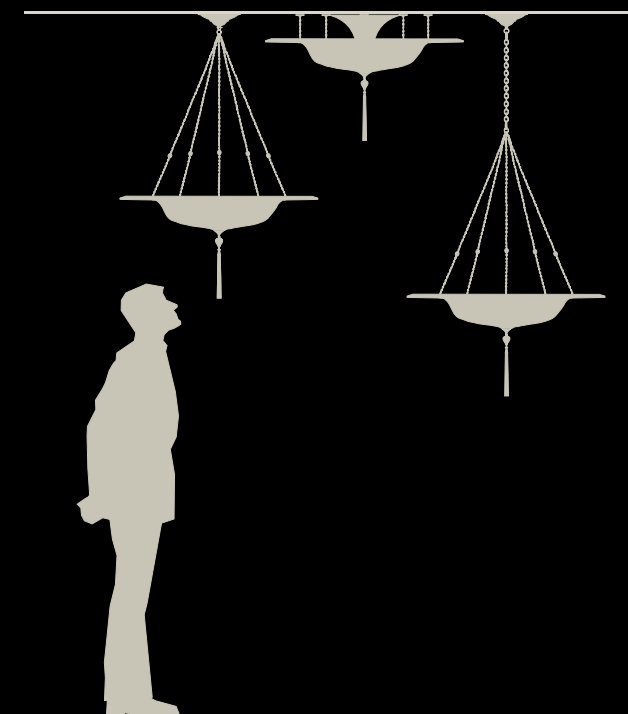

Silver Classic



White Classic



Gold Mosaic



Red Mosaic





SAMARKANDA GLASS

Samarkand is a city in present day Uzbekistan, and lies on the famous Silk Road trade route linking Venice and China.

This lamp's unique shape and quintessential Fortuny pattern evoke the mystique of those ancient trade journeys, and the cultural fusion they sparked.

The light filters through the glass and penetrates the inlay of the decorative ring.



Gold Serpentine

Art. G041 SK

Silver Serpentine

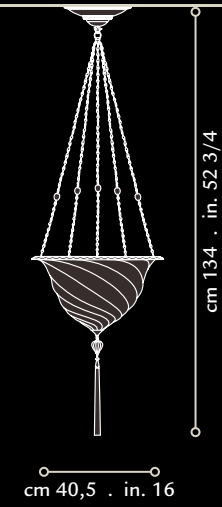

Structure: glass, brass, burnished metal,
murano glass beads
Weight: kg 6 . lb.13 oz.4
Wattage: 1 x max 100W
Voltage: 1xE26 socket 110V
1xE27 socket 220/240V
also suitable for LED light bulbs

Types

White Serpentine

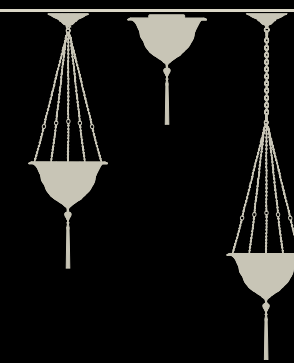



SAMARKANDA
with metal ring

Art. G069 SKC

Samarkanda
with metal ring

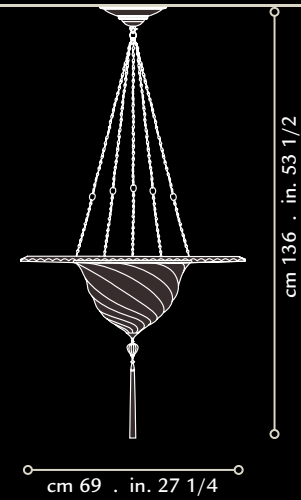

Structure: glass, brass, burnished metal
murano glass beads
Weight: kg 6,5 . lb.14 oz.5
Wattage: 1 x max100W
Voltage: 1xE26 socket 110V
1xE27 socket 220/240V
also suitable for LED light bulbs

Art. G041 AP

Samarkanda
applique

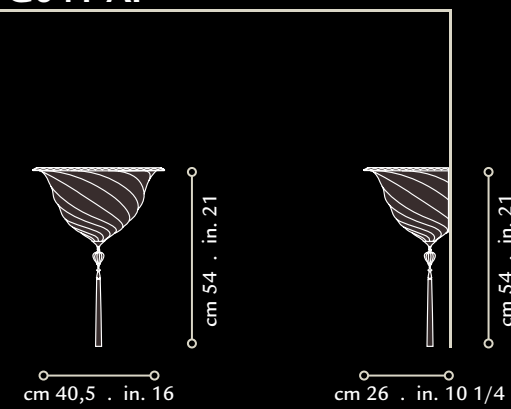

Structure: glass, brass, burnished metal
murano glass beads
Weight: kg 3 . lb.6 oz.10
Wattage: 1 x max75W
Voltage: 1xE26 socket 110V
1xE27 socket 220/240V
also suitable for LED light bulbs





CESENDELLO GLASS

A cesendello, or sanctuary lamp, has its roots in Rome and Byzantium, and later became popular in Venice and the Muslim world.

The profile of this elegant spiral structure recalls the twist of a turban.

The refined silhouette represents the synthesis of the Oriental and Renaissance themes present in Venice as early as the 15th century.

Choose from 5 patterns: gold mosaic, red mosaic, white, gold and silver.

The Cesendello Cascade is available in 33 and 25 shade compositions.



Gold Classic

CESENDELLO

Art. G019 CE-1

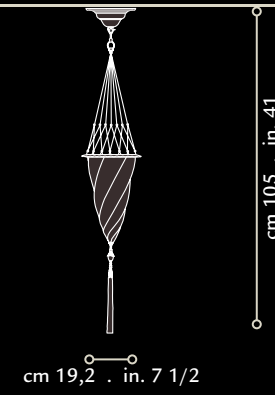

Art. G019 CE-2

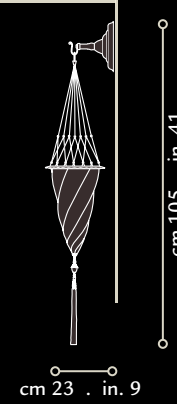

Structure: glass, brass, burnished metal
 murano glass beads
 Weight: kg 2,3 . lb.5 oz.1
 Wattage: 1 x max60W
 Voltage: 1xE12 socket 110V
 1xE14 socket 220/240V
 also suitable for LED light bulbs



Silver Classic

White Classic



Gold Mosaic

Red Mosaic





CESENDELLO
with metal ring

Gold Classic

Art. G029 CEC-1 Art. G029 CEC-1

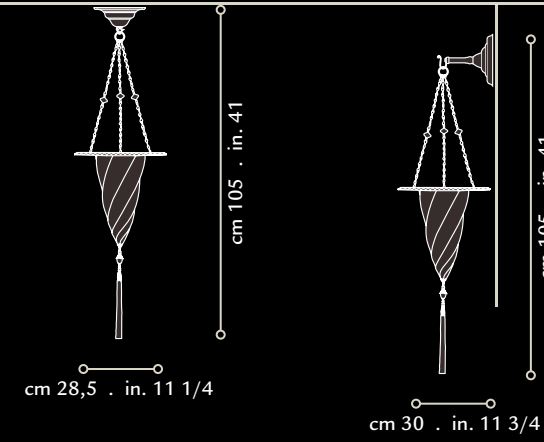

Cesendello
with metal ring



Structure: glass, brass, burnished metal
murano glass beads
Weight: kg 2,6 . lb.5 oz.12
Wattage: 1 x max60W
Voltage: 1xE12 socket 110V
1xE14 socket 220/240V
also suitable for LED light bulbs

Art. G019 AP

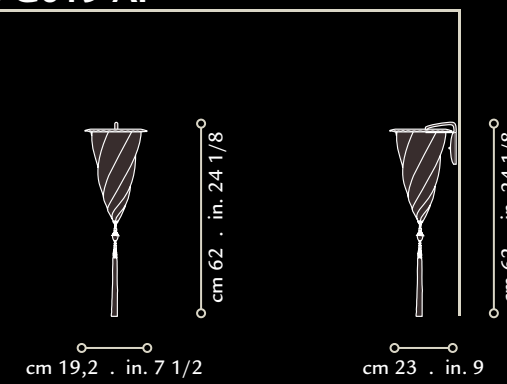

Cesendello
applique



Structure: glass, brass, burnished metal
murano glass beads
Weight: kg 2,3 . lb.5 oz.1
Wattage: 1 x max60W
Voltage: 1xE12 socket 110V
1xE14 socket 220/240V
also suitable for LED light bulbs



CESENDELLO
arc wall triple

Art. GCM 019-3

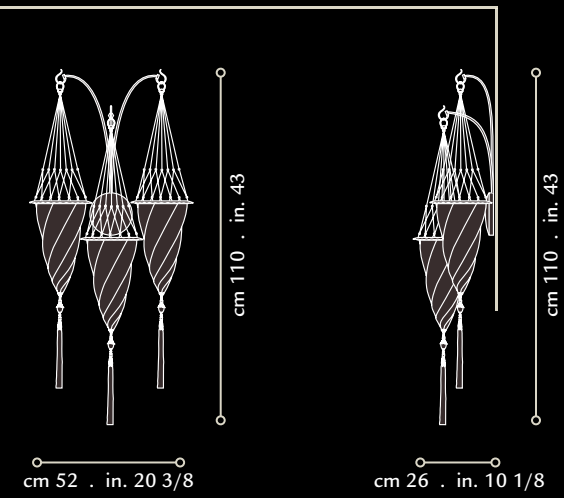

Structure: glass, brass, burnished metal
 murano glass beads
 Weight: kg 7 . lb.15 oz.7
 Wattage: 1 x max60W (per shade)
 Voltage: 1xE12 socket 110V
 1xE14 socket 220/240V
 also suitable for LED light bulbs

Cesendello
arc wall triple



Art. GCM 019-1

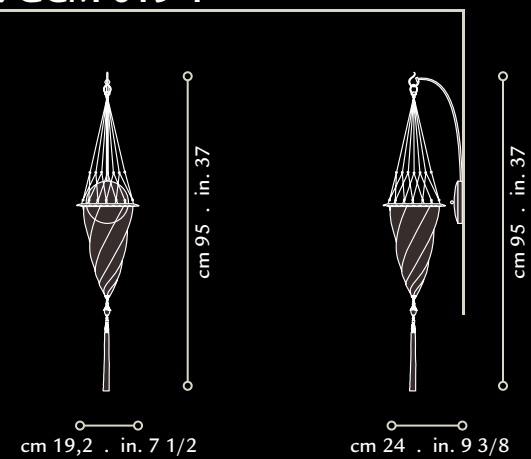

Structure: glass, brass, burnished metal
 murano glass beads
 Weight: kg 3,6 . lb.7 oz.15
 Wattage: 1 x max60W
 Voltage: 1xE12 socket 110V
 1xE14 socket 220/240V
 also suitable for LED light bulbs

Cesendello
arc wall



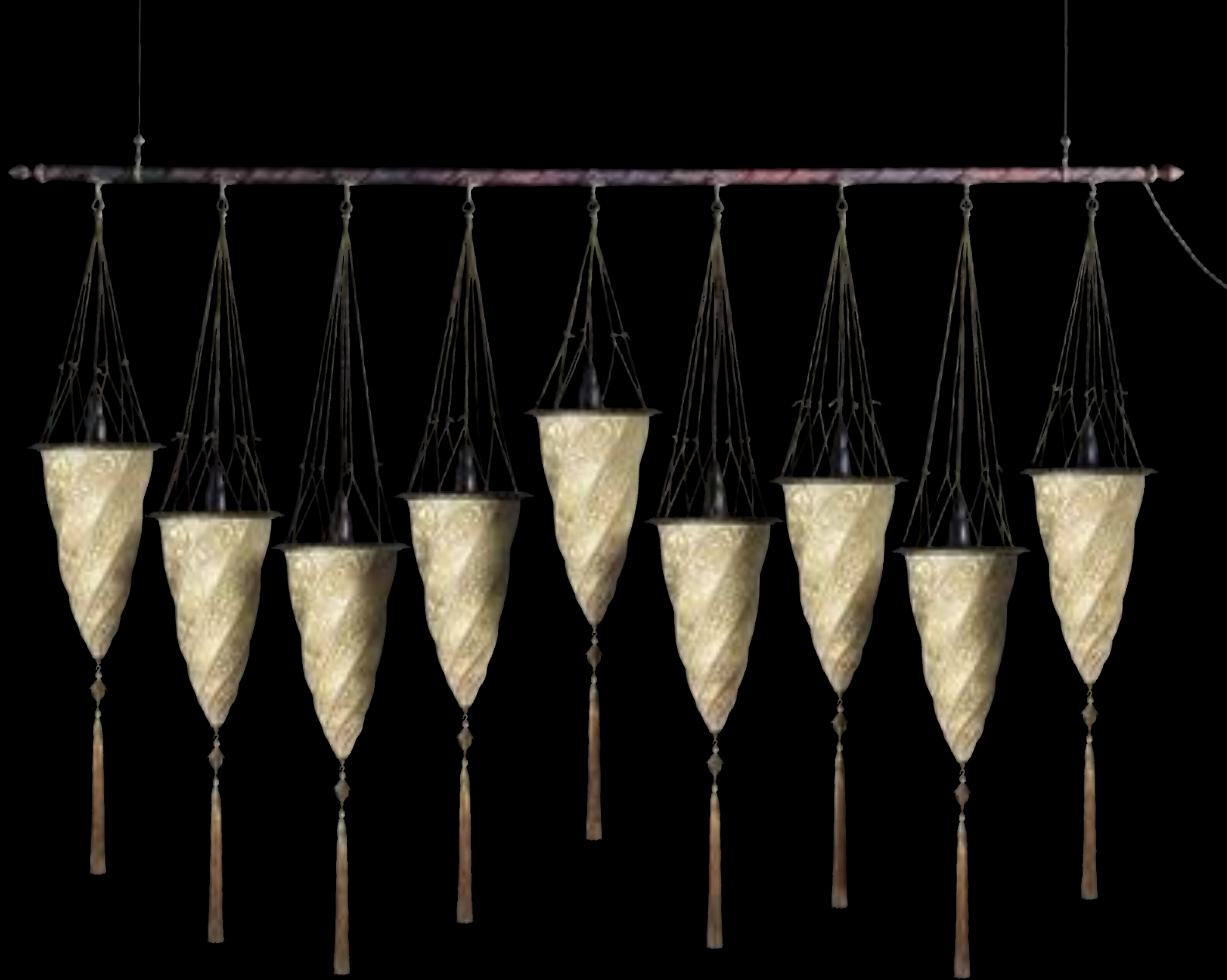

Art. GAF 019-3

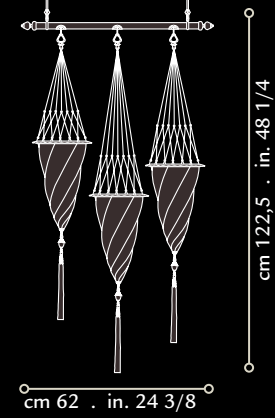

Art. GAF 019-4

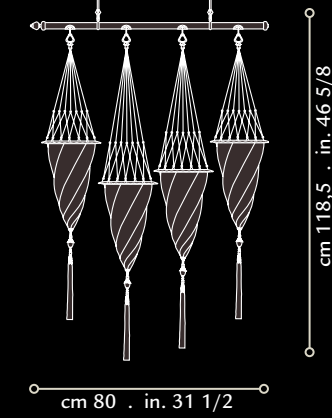

Art. GAF 019-5

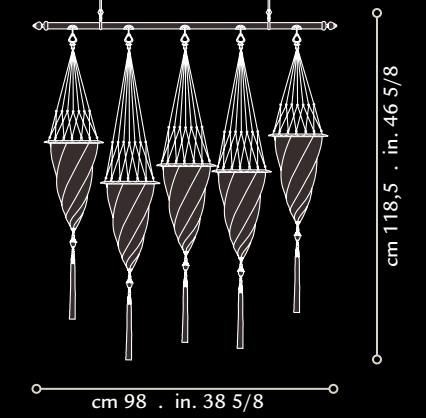

Art. GAF 019-6

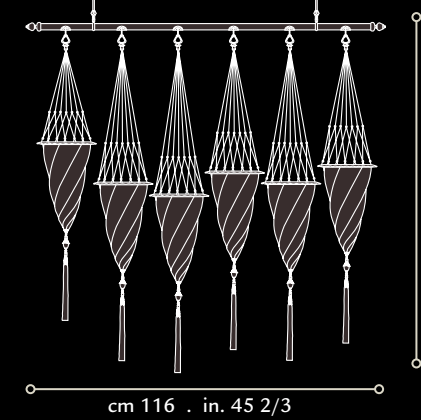

Art. GAF 019-7

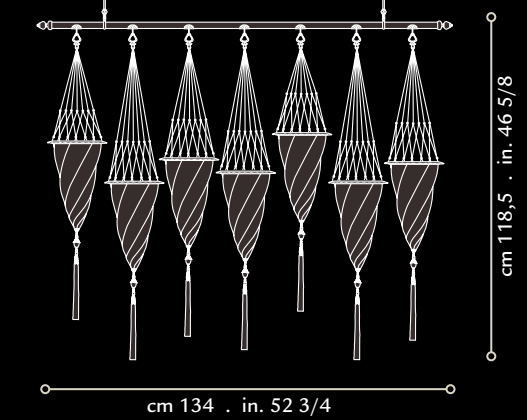

Art. GAF 019-8

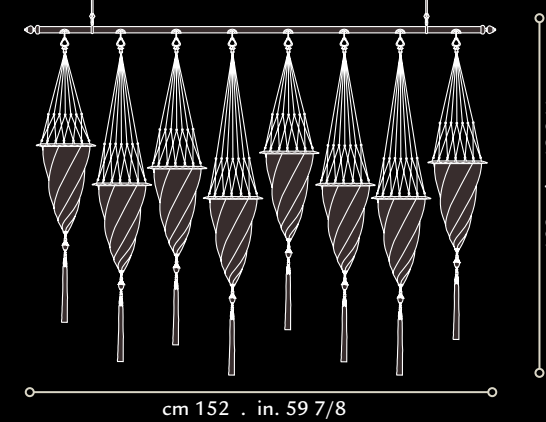

Art. GAF 019-9

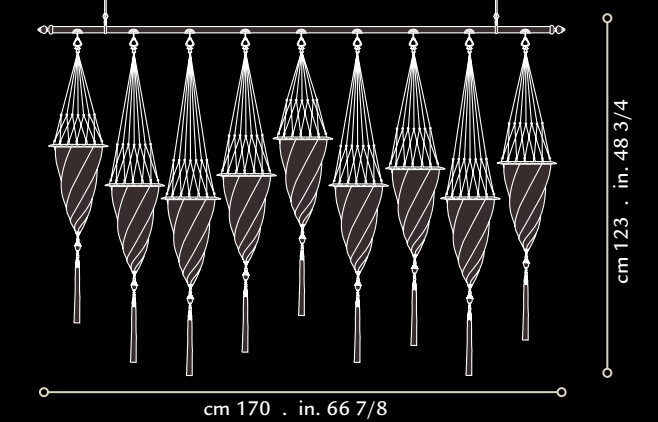

CESENDELLO
on a rod

Structure: glass, brass, burnished metal,
murano glass beads
rod covered with fabric

Weight: kg 1,9 . lb.4 oz.3 (per shade)
Wattage: 1 x max60W (per shade)
Voltage: 1xE12 socket 110V . 1xE14 socket 220/240V
also suitable for LED light bulbs



red stand



green stand

CESNDELLO
floor lamp

Art. G174 ST

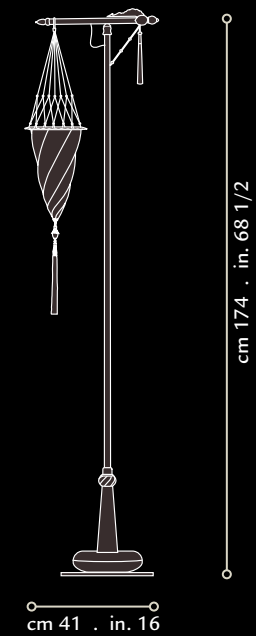

Structure: glass, brass, burnished metal,
murano glass beads,
stand covered with fabric
Base: cast iron
Base cover: velvet
Weight: kg 8 . lb.17 oz.10
Wattage: 1 x max60W
Voltage: 1xE12 socket 110V
1xE14 socket 220/240V
also suitable for LED light bulbs

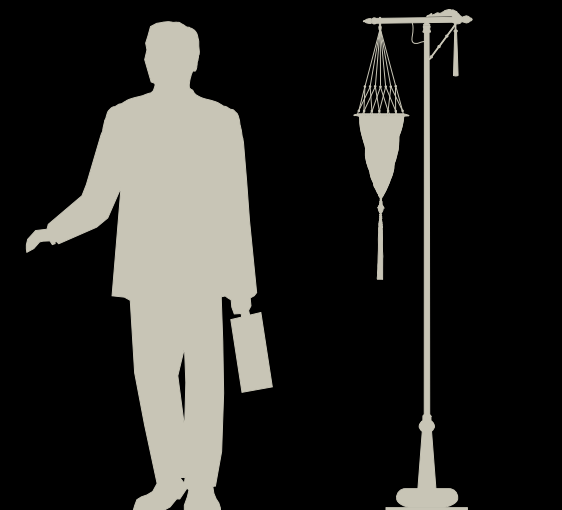



Interior Design: Olivier Chetail





CESENDELLO CASCADE

Art. GCM019-33

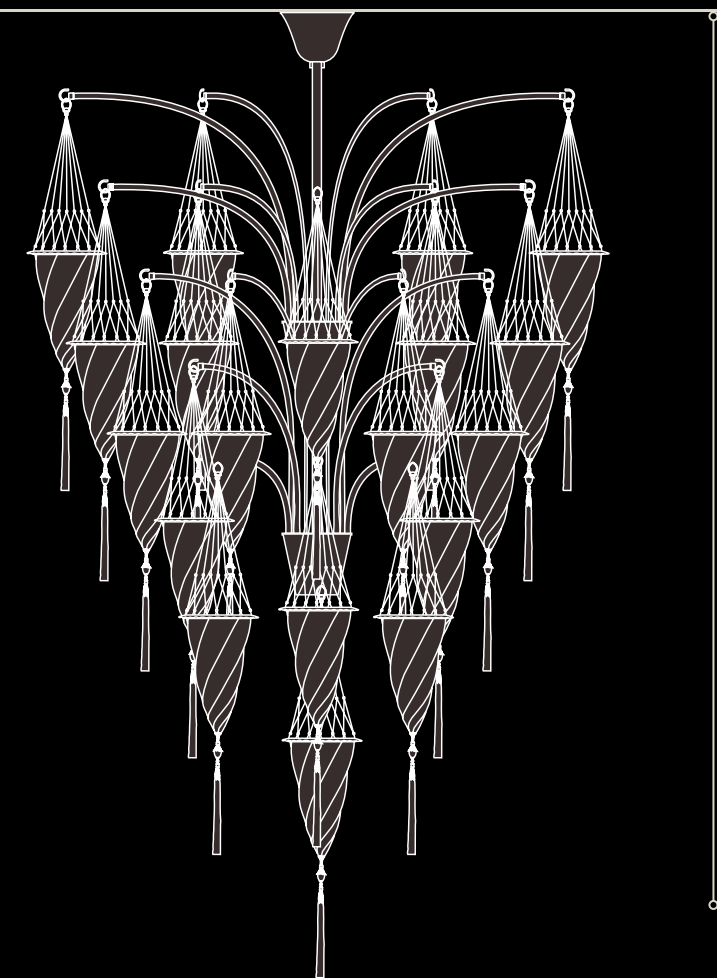

cm 140 - in. 54 5/8

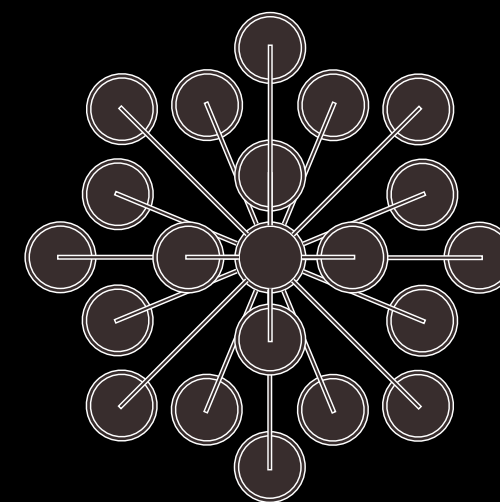

Structure: glass, brass, burnished metal,
murano glass beads

Weight: kg 70 . lb.154 oz.5

Wattage: 33 x max 40W

Voltage: E12 socket 110V . E14 socket 220/240V
also suitable for LED light bulbs



CESENDELLO CHANDELIER

Art. GCM 019-9

Cesendello chandelier
9 cesendello

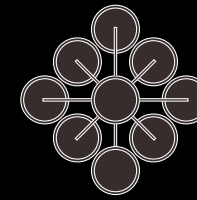
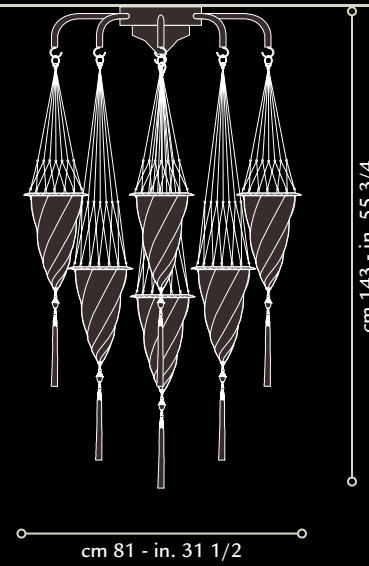

Art. GCM 019-7

Cesendello chandelier
7 cesendello

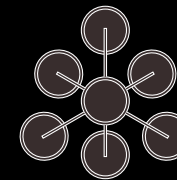
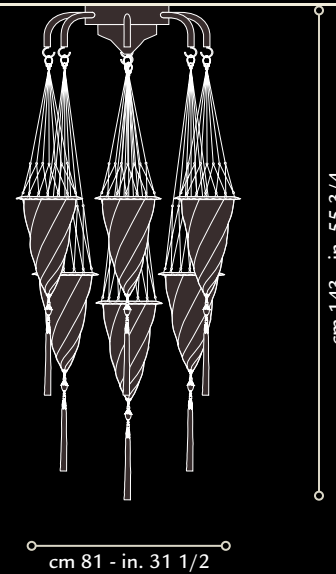

Art. GCM 019-5

Cesendello chandelier
5 cesendello

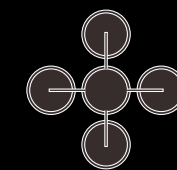
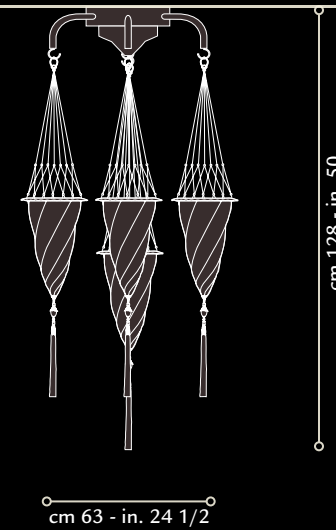

Structure: glass, brass, burnished metal,
murano glass beads

Weight: kg 1,9 . lb.4 oz.3 (per shade)
Wattage: 1 x max 60W (per shade)
Voltage: E12 socket 110V . E14 socket 220/240V
also suitable for LED light bulbs



MARIANO FORTUNY

Artist, photographer, designer... it is hard to single out which aspect of the personality and work of Mariano Fortuny was predominant.

His entire artistic production was based on an extraordinary synthesis of worlds and eras, of styles and techniques that only in Venice, a melting pot of civilizations, could be transformed into the creation of exquisite products.

Through philological experimentation inspired by the noble roots of Western art and the magic of the Orient, Mariano Fortuny became one of the most original interpreters of Venice's "Silver Age".

His constant research into lighting led him to file a number of patents, including a device to control light intensity, used in the world's most prestigious theatres.

Design protected.

On request, all our lamps can be produced for North America according to UL* standards and for Europe according to CE standards.

The company reserves the right to modify its products without warning. Colours and patterns may differ slightly from the ones featured in this catalogue.

No part of this work may be reproduced or transmitted in any form or by any means without prior permission. All rights reserved. Made in Venice - Italy

*with the exception of floorstand and rod.



FORTVNY®

www.fortuny.it
info@fortuny.it

Fortuny S.r.l.
San Marco, 2425 30124 Venezia - Italy
T. +39 (0)41 52 36 953 F. +39 (0)41 52 27 353

Shops:

Italy

Fortuny Venezia sas
Calle XXII Marzo, 2428
San Marco - 30124 Venezia
T. +39 (0)41 52 00 505

Fortuny Venezia sas
Calle del traghetto, 180/A
Dorsoduro - 30123 Venezia
T. +39 (0)41 52 10 187

France

Fortuny sas
17, rue Bonaparte
75006 Paris
T. +33 (0)1 43 29 85 74

Germany

Fortuny GmbH
9, Brienner Str.
80333 München
T. +49 (0)89 76 75 77 82