

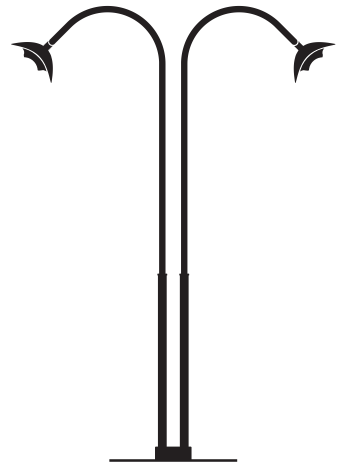

**phormalab**  
Heating solutions

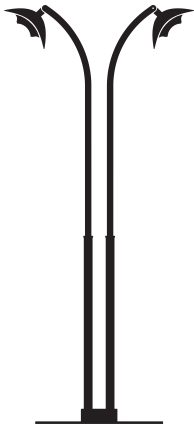
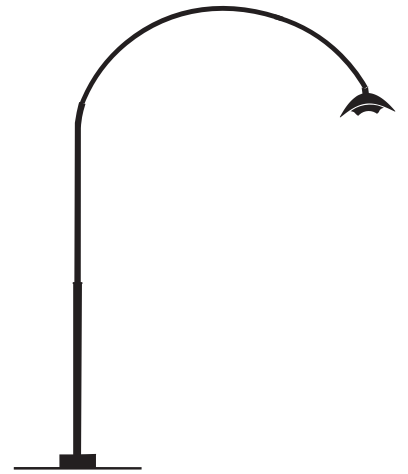
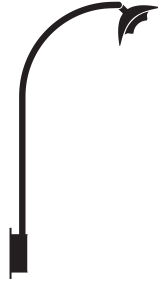

# hotdoor

NEXT GENERATION HEATER

Da una secolare esperienza nella lavorazione dei metalli, nasce il *Progetto Hotdoor*, con il quale la tradizione manifatturiera incontra il design.

Il risultato è un riscaldatore a raggi infrarossi, ideale per l'esterno, solido e funzionale, e, al tempo stesso, dal design raffinato ed elegante.

From a secular experience in metalworking, arises *Hotdoor Project*, where the manufacturing tradition meets design.

The result is an infrared heater, ideal for outdoor use, solid and functional and, at the same time, with a refined and elegant design.

Aus einer Jahrhunderte langen Erfahrung in der Metallverarbeitung, kommt das *Hotdoor Projekt*, wo die Manufakturtradition auf Design trifft.

Das Ergebnis ist ein Infrarotstrahler, ideal für den Außeneinsatz, solide und funktional und zugleich mit einem raffinierten und eleganten Design.

D'une expérience séculaire dans la métallurgie, naît le *Projet Hotdoor*, ou la tradition manufacturière rencontre le design.

Il en résulte une lampe de chauffage à infrarouge, idéale pour l'extérieur, solide, fonctionnelle et avec une conception élégante et raffinée.

Desde una experiencia secular en la metalurgia, nace el *Proyecto Hotdoor*, con el que se reúne la tradición manufacturera y el design.

El resultado es un lámpara infraroja de calefacción, ideal para uso al aire libre, sólida y funcional y, al mismo tiempo, con un design refinado y elegante.

# hotdoor

## NEXT GENERATION HEATER



- Disegnato e prodotto totalmente in Italia
- Corpo e supporti in alluminio pressofuso
- Lampada infrarossi: Philips-Dr. Fischer con tecnologia HeLeN
- Durata della lampadina: 5.000 ore circa
- Grado di protezione: IPX5 (la lampada è utilizzabile anche in spazi esterni e resiste agli spruzzi d'acqua)
- Potenze disponibili: 1500, 2000 W
- Alimentazione: 230 V – 50/60 Hz (disponibile anche 110 V)
- Oltre il 90% dell'energia assorbita viene emessa sotto forma di raggi infrarossi
- Fascio scaldante orientabile alto/basso grazie a uno snodo standard; snodo supplementare per orientamento destra/sinistra
- Gamma: con attacco a parete o a soffitto, con piantana, singola e doppia
- Colori:
  - corpo lampada e accessori: nero o bianco
  - frontale: satinato, cromato, oro, bianco, nero



- Designed and completely manufactured in Italy
- Heater body and accessories in die-casting aluminium
- Infrared bulb: Philips-Dr. Fischer by HeLeN technology
- Bulb life: about 5.000 hours
- Protection level: IPX5 (the lamp can be used outdoors and assures perfect impermeability against sprinkling of water)
- Available powers: 1500, 2000 W
- Power supply: 230 V – 50/60 Hz (available 110 V)
- More than 90% of the absorbed energy is radiated as infrared emission
- The heater can be oriented by an up/down adjustable joint included (supplementary left/right adjustable joint available)
- Range: wall mounting, ceiling mounting, floor stem
- Colors:
  - heater body and accessories: black or white
  - front cover: satinized grey, chrome, gold, white, black



- Italienisches Design und völlig hergestellt in Italien
- Strahlerkörper und Zubehöre aus Pressgussaluminium
- Infrarot Heizelement: HeLeN Technologie von Philips-Dr. Fischer
- Dauer des Heizelements: 5.000 Stunden ungefähr
- Schutzart: IPX5 (Strahler nutzbar in Außerräumen und Spritzwasser- und Regenfest)
- Verfügbare Leistungen: 1500, 2000 W
- Stromzufuhr: 230 V – 50/60 Hz (verfügbar 110 V)
- Über 90% der absorbierten Energie strahlt als Infrarotstrahlung aus
- Die Heizstrahler kann durch eine nach oben/unten verstellbare Gelenkkupplung verstellt werden (zusätzlich links/rechts einstellbare Gelenkkupplung verfügbar)
- Verfügbare Lösungen: Wandhalterung, Deckenhalterung, Fußbodenständer
- Verfügbare Farben:
  - Körper und Befestigungselemente: Schwarz oder Weiß
  - Vorabdeckung: satiniert Grau, Chrom, Gold, Weiß, Schwarz



- Design et production italienne
- Corps de la lampe et accessoires en aluminium moulé sous pression
- Ampoule infrarouge: Philips-Dr. Fischer avec technologie HeLeN
- Durée de l'ampoule : 5.000 heures à peu près
- Protection: IPX5 (la lampe peut être utilisée à l'extérieur et est imperméable aux jets d'eau et à la pluie)
- Puissances disponibles : 1500, 2000 W
- Alimentation : 230 V – 50/60 Hz (disponible aussi 110 V)
- Plus que 90% de l'énergie absorbée vient réémise comme radiation infrarouge
- Lampe orientable haut/bas par une rotule mécanique (disponible aussi rotule supplémentaire droite/gauche)
- Solutions : appliques, plafonniers, lampadaires
- Couleurs disponibles :
  - corps de la lampe et accessoires : blanc ou noir
  - couverture antérieure : gris satiné, chrome brillant, or, blanc, noir



- Diseñada y producida totalmente en Italia
- Cuerpo y accesorios de aluminio vaciado a presión
- Bombillas infrarrojas: Philips-Dr. Fischer - Tecnología HeLeN
- Duración de la bombilla: 5.000 horas aproximadamente
- Grado de protección: IPX5 (la lámpara puede ser utilizada al exterior, resistente a las salpicaduras de agua y a la lluvia)
- Potencias disponibles: 1500, 2000 W
- Alimentación: 230 V - 50/60 Hz (110 V también disponible)
- Más del 90% de la energía absorbida es emitida en forma de radiación infrarroja
- Haz de rayos infrarrojos regulable alto/bajo gracias a una junta articulable (disponible también una junta articulable adicional para la orientación derecha/izquierda)
- Gama: soporte a pared o techo, de pie, individuales y dobles
- Colores:
  - cuerpo de la lámpara y accesorios: negro o blanco
  - cobertura anterior: gris satinado, cromo, oro, blanco, negro







COMPOSIZIONI  
VERSIONS  
KOMPOSITIONEN  
COMPOSITIONS  
COMPOSICIONES

Attacco singolo a parete / Single Wall Mounting / Kurze Einzelwandhalterung  
Applique murale / Soporte a pared



**Attacco singolo a parete / Single Wall Mounting / Kurze Einzelwandhalterung**  
**Applique murale / Soporte a pared**

|   |               |   |               |   |               |  |               |   |               |
|---|---------------|---|---------------|---|---------------|--|---------------|---|---------------|
| Nero + Nero   |               | Nero + Bianco   |               | Nero + Cromo  |               | Nero + Oro   |               | Nero + Grigio satinato  |               |
| Black + Black   |               | Black + White   |               | Black + Chrome  |               | Black + Gold   |               | Black + Satin Gray  |               |
| Schwarz + Schwarz   |               | Schwarz + Weiß  |               | Schwarz + Chrom   |               | Schwarz + Gold   |               | Schwarz + Satiniert Grau  |               |
| Noir + Noir   |               | Noir + Blanc  |               | Noir + Chrome   |               | Noir + Or  |               | Noir + Gris satiné  |               |
| Negro + Negro   |               | Negro + Blanco  |               | Negro + Cromo   |               | Negro + Dorado   |               | Negro + Gris Satinado   |               |
|  |               |  |               |  |               |  |               |  |               |
| 1500 W  | HAA0101010015 | 1500 W  | HAA0101020015 | 1500 W  | HAA0101030015 | 1500 W   | HAA0101040015 | 1500 W  | HAA0101050015 |
| 2000 W  | HAA0101010020 | 2000 W  | HAA0101020020 | 2000 W  | HAA0101030020 | 2000 W   | HAA0101040020 | 2000 W  | HAA0101050020 |

|   |               |   |               |   |               |  |               |   |               |
|---|---------------|---|---------------|---|---------------|--|---------------|---|---------------|
| Bianco + Nero   |               | Bianco + Bianco   |               | Bianco + Cromo  |               | Bianco + Oro   |               | Bianco + Grigio satinato  |               |
| White + Black   |               | White + White   |               | White + Chrome  |               | White + Gold   |               | White + Satin Gray  |               |
| Weiß + Schwarz  |               | Weiß + Weiß   |               | Weiß + Chrom  |               | Weiß + Gold  |               | Weiß + Satiniert Grau   |               |
| Blanc + Noir  |               | Blanc + Blanc   |               | Blanc + Chrome  |               | Blanc + Or   |               | Blanc + Gris satiné   |               |
| Blanco + Negro  |               | Blanco + Blanco   |               | Blanco + Cromo  |               | Blanco + Dorado  |               | Blanco + Gris Satinado  |               |
|  |               |  |               |  |               |  |               |  |               |
| 1500 W  | HAA0102010015 | 1500 W  | HAA0102020015 | 1500 W  | HAA0102030015 | 1500 W   | HAA0102040015 | 1500 W  | HAA0102050015 |
| 2000 W  | HAA0102010020 | 2000 W  | HAA0102020020 | 2000 W  | HAA0102030020 | 2000 W   | HAA0102040020 | 2000 W  | HAA0102050020 |

Dimensioni / Dimensions /  
 Abmessungen / Dimensions  
 Dimensiones / mm

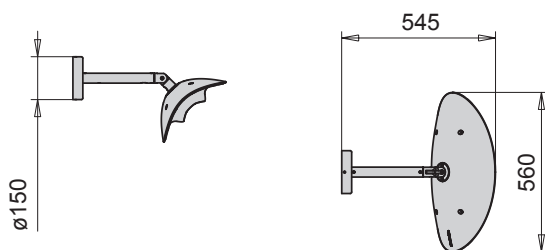

Imballo / Packaging /  
 Verpackung / Emballage  
 Embalaje / mm

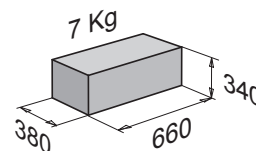

Attacco a parete con stelo / Wall stem with arc / Einzelwandhalterung mit Bogen  
Applique murale avec tige arc / Soporte a pared con arco





|   |               |   |               |   |               |  |               |   |               |
|---|---------------|---|---------------|---|---------------|--|---------------|---|---------------|
| Nero + Nero   |               | Nero + Bianco   |               | Nero + Cromo  |               | Nero + Oro   |               | Nero + Grigio satinato  |               |
| Black + Black   |               | Black + White   |               | Black + Chrome  |               | Black + Gold   |               | Black + Satin Gray  |               |
| Schwarz + Schwarz   |               | Schwarz + Weiß  |               | Schwarz + Chrom   |               | Schwarz + Gold   |               | Schwarz + Satiniert Grau  |               |
| Noir + Noir   |               | Noir + Blanc  |               | Noir + Chrome   |               | Noir + Or  |               | Noir + Gris satiné  |               |
| Negro + Negro   |               | Negro + Blanco  |               | Negro + Cromo   |               | Negro + Dorado   |               | Negro + Gris Satinado   |               |
|  |               |  |               |  |               |  |               |  |               |
| 1500 W  | HAA1101010015 | 1500 W  | HAA1101020015 | 1500 W  | HAA1101030015 | 1500 W   | HAA1101040015 | 1500 W  | HAA1101050015 |
| 2000 W  | HAA1101010020 | 2000 W  | HAA1101020020 | 2000 W  | HAA1101030020 | 2000 W   | HAA1101040020 | 2000 W  | HAA1101050020 |

|   |               |   |               |   |               |  |               |   |               |
|---|---------------|---|---------------|---|---------------|--|---------------|---|---------------|
| Bianco + Nero   |               | Bianco + Bianco   |               | Bianco + Cromo  |               | Bianco + Oro   |               | Bianco + Grigio satinato  |               |
| White + Black   |               | White + White   |               | White + Chrome  |               | White + Gold   |               | White + Satin Gray  |               |
| Weiß + Schwarz  |               | Weiß + Weiß   |               | Weiß + Chrom  |               | Weiß + Gold  |               | Weiß + Satiniert Grau   |               |
| Blanc + Noir  |               | Blanc + Blanc   |               | Blanc + Chrome  |               | Blanc + Or   |               | Blanc + Gris satiné   |               |
| Blanco + Negro  |               | Blanco + Blanco   |               | Blanco + Cromo  |               | Blanco + Dorado  |               | Blanco + Gris Satinado  |               |
|  |               |  |               |  |               |  |               |  |               |
| 1500 W  | HAA1102010015 | 1500 W  | HAA1102020015 | 1500 W  | HAA1102030015 | 1500 W   | HAA1102040015 | 1500 W  | HAA1102050015 |
| 2000 W  | HAA1102010020 | 2000 W  | HAA1102020020 | 2000 W  | HAA1102030020 | 2000 W   | HAA1102040020 | 2000 W  | HAA1102050020 |

Dimensioni / Dimensions /  
Abmessungen / Dimensions  
Dimensiones / mm

Imballo / Packaging /  
Verpackung / Emballage  
Embalaje / mm

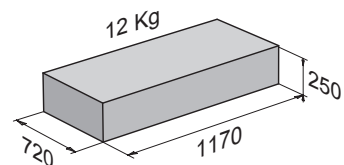
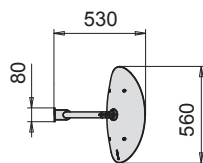
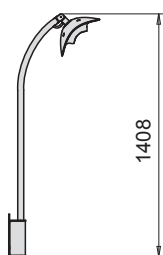

|  |               |   |               |   |               |  |               |   |               |
|--|---------------|---|---------------|---|---------------|--|---------------|---|---------------|
| Nero + Nero  |               | Nero + Bianco   |               | Nero + Cromo  |               | Nero + Oro   |               | Nero + Grigio satinato  |               |
| Black + Black  |               | Black + White   |               | Black + Chrome  |               | Black + Gold   |               | Black + Satin Gray  |               |
| Schwarz + Schwarz  |               | Schwarz + Weiß  |               | Schwarz + Chrom   |               | Schwarz + Gold   |               | Schwarz + Satiniert Grau  |               |
| Noir + Noir  |               | Noir + Blanc  |               | Noir + Chrome   |               | Noir + Or  |               | Noir + Gris satiné  |               |
| Negro + Negro  |               | Negro + Blanco  |               | Negro + Cromo   |               | Negro + Dorado   |               | Negro + Gris Satinado   |               |
|  |               |  |               |  |               |  |               |  |               |
| 1500 W   | HAA1201010015 | 1500 W  | HAA1201020015 | 1500 W  | HAA1201030015 | 1500 W   | HAA1201040015 | 1500 W  | HAA1201050015 |
| 2000 W   | HAA1201010020 | 2000 W  | HAA1201020020 | 2000 W  | HAA1201030020 | 2000 W   | HAA1201040020 | 2000 W  | HAA1201050020 |

|  |               |   |               |   |               |  |               |   |               |
|--|---------------|---|---------------|---|---------------|--|---------------|---|---------------|
| Bianco + Nero  |               | Bianco + Bianco   |               | Bianco + Cromo  |               | Bianco + Oro   |               | Bianco + Grigio satinato  |               |
| White + Black  |               | White + White   |               | White + Chrome  |               | White + Gold   |               | White + Satin Gray  |               |
| Weiß + Schwarz   |               | Weiß + Weiß   |               | Weiß + Chrom  |               | Weiß + Gold  |               | Weiß + Satiniert Grau   |               |
| Blanc + Noir   |               | Blanc + Blanc   |               | Blanc + Chrome  |               | Blanc + Or   |               | Blanc + Gris satiné   |               |
| Blanco + Negro   |               | Blanco + Blanco   |               | Blanco + Cromo  |               | Blanco + Dorado  |               | Blanco + Gris Satinado  |               |
|  |               |  |               |  |               |  |               |  |               |
| 1500 W   | HAA1202010015 | 1500 W  | HAA1202020015 | 1500 W  | HAA1202030015 | 1500 W   | HAA1202040015 | 1500 W  | HAA1202050015 |
| 2000 W   | HAA1202010020 | 2000 W  | HAA1202020020 | 2000 W  | HAA1202030020 | 2000 W   | HAA1202040020 | 2000 W  | HAA1202050020 |

Dimensioni / Dimensions /  
Abmessungen / Dimensions  
Dimensiones / mm

Imballo / Packaging /  
Verpackung / Emballage  
Embalaje / mm

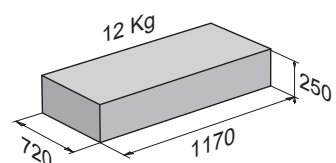
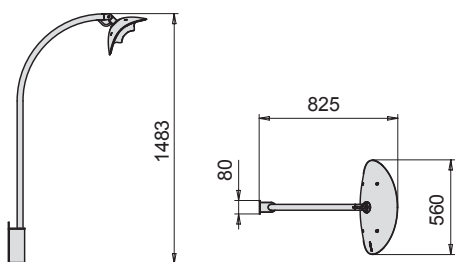

|   |               |   |               |   |               |  |               |   |               |
|---|---------------|---|---------------|---|---------------|--|---------------|---|---------------|
| Nero + Nero   |               | Nero + Bianco   |               | Nero + Cromo  |               | Nero + Oro   |               | Nero + Grigio satinato  |               |
| Black + Black   |               | Black + White   |               | Black + Chrome  |               | Black + Gold   |               | Black + Satin Gray  |               |
| Schwarz + Schwarz   |               | Schwarz + Weiß  |               | Schwarz + Chrom   |               | Schwarz + Gold   |               | Schwarz + Satiniert Grau  |               |
| Noir + Noir   |               | Noir + Blanc  |               | Noir + Chrome   |               | Noir + Or  |               | Noir + Gris satiné  |               |
| Negro + Negro   |               | Negro + Blanco  |               | Negro + Cromo   |               | Negro + Dorado   |               | Negro + Gris Satinado   |               |
|  |               |  |               |  |               |  |               |  |               |
| 1500 W  | HAA1301010015 | 1500 W  | HAA1301020015 | 1500 W  | HAA1301030015 | 1500 W   | HAA1301040015 | 1500 W  | HAA1301050015 |
| 2000 W  | HAA1301010020 | 2000 W  | HAA1301020020 | 2000 W  | HAA1301030020 | 2000 W   | HAA1301040020 | 2000 W  | HAA1301050020 |





|   |               |   |               |   |               |  |               |   |               |
|---|---------------|---|---------------|---|---------------|--|---------------|---|---------------|
| Bianco + Nero   |               | Bianco + Bianco   |               | Bianco + Cromo  |               | Bianco + Oro   |               | Bianco + Grigio satinato  |               |
| White + Black   |               | White + White   |               | White + Chrome  |               | White + Gold   |               | White + Satin Gray  |               |
| Weiß + Schwarz  |               | Weiß + Weiß   |               | Weiß + Chrom  |               | Weiß + Gold  |               | Weiß + Satiniert Grau   |               |
| Blanc + Noir  |               | Blanc + Blanc   |               | Blanc + Chrome  |               | Blanc + Or   |               | Blanc + Gris satiné   |               |
| Blanco + Negro  |               | Blanco + Blanco   |               | Blanco + Cromo  |               | Blanco + Dorado  |               | Blanco + Gris Satinado  |               |
|  |               |  |               |  |               |  |               |  |               |
| 1500 W  | HAA1302010015 | 1500 W  | HAA1302020015 | 1500 W  | HAA1302030015 | 1500 W   | HAA1302040015 | 1500 W  | HAA1302050015 |
| 2000 W  | HAA1302010020 | 2000 W  | HAA1302020020 | 2000 W  | HAA1302030020 | 2000 W   | HAA1302040020 | 2000 W  | HAA1302050020 |





Dimensioni / Dimensions /  
Abmessungen / Dimensions  
Dimensiones / mm

Imballo / Packaging /  
Verpackung / Emballage  
Embalaje / mm

Piantana singola / Floor single stem Lamp / Einzelfußbodenständer / Lampadaire single  
Lampara de pie individual



|   |               |   |               |   |               |  |               |   |               |
|---|---------------|---|---------------|---|---------------|--|---------------|---|---------------|
| Nero + Nero   |               | Nero + Bianco   |               | Nero + Cromo  |               | Nero + Oro   |               | Nero + Grigio satinato  |               |
| Black + Black   |               | Black + White   |               | Black + Chrome  |               | Black + Gold   |               | Black + Satin Gray  |               |
| Schwarz + Schwarz   |               | Schwarz + Weiß  |               | Schwarz + Chrom   |               | Schwarz + Gold   |               | Schwarz + Satiniert Grau  |               |
| Noir + Noir   |               | Noir + Blanc  |               | Noir + Chrome   |               | Noir + Or  |               | Noir + Gris satiné  |               |
| Negro + Negro   |               | Negro + Blanco  |               | Negro + Cromo   |               | Negro + Dorado   |               | Negro + Gris Satinado   |               |
|  |               |  |               |  |               |  |               |  |               |
| 1500 W  | HCA0101010015 | 1500 W  | HCA0101020015 | 1500 W  | HCA0101030015 | 1500 W   | HCA0101040015 | 1500 W  | HCA0101050015 |
| 2000 W  | HCA0101010020 | 2000 W  | HCA0101020020 | 2000 W  | HCA0101030020 | 2000 W   | HCA0101040020 | 2000 W  | HCA0101050020 |



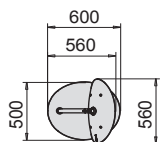
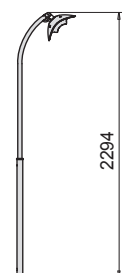

|   |               |   |               |   |               |  |               |   |               |
|---|---------------|---|---------------|---|---------------|--|---------------|---|---------------|
| Bianco + Nero   |               | Bianco + Bianco   |               | Bianco + Cromo  |               | Bianco + Oro   |               | Bianco + Grigio satinato  |               |
| White + Black   |               | White + White   |               | White + Chrome  |               | White + Gold   |               | White + Satin Gray  |               |
| Weiß + Schwarz  |               | Weiß + Weiß   |               | Weiß + Chrom  |               | Weiß + Gold  |               | Weiß + Satiniert Grau   |               |
| Blanc + Noir  |               | Blanc + Blanc   |               | Blanc + Chrome  |               | Blanc + Or   |               | Blanc + Gris satiné   |               |
| Blanco + Negro  |               | Blanco + Blanco   |               | Blanco + Cromo  |               | Blanco + Dorado  |               | Blanco + Gris Satinado  |               |
|  |               |  |               |  |               |  |               |  |               |
| 1500 W  | HCA0102010015 | 1500 W  | HCA0102020015 | 1500 W  | HCA0102030015 | 1500 W   | HCA0102040015 | 1500 W  | HCA0102050015 |
| 2000 W  | HCA0102010020 | 2000 W  | HCA0102020020 | 2000 W  | HCA0102030020 | 2000 W   | HCA0102040020 | 2000 W  | HCA0102050020 |

Dimensioni / Dimensions /  
Abmessungen / Dimensions  
Dimensiones / mm

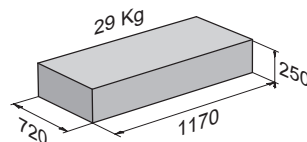

Imballo / Packaging /  
Verpackung / Emballage  
Embalaje / mm

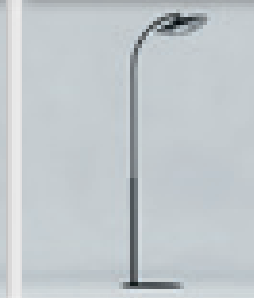

|  |   |   |  |   |
|--|---|---|--|---|
| Nero + Nero  | Nero + Bianco   | Nero + Cromo  | Nero + Oro   | Nero + Grigio satinato  |
| Black + Black  | Black + White   | Black + Chrome  | Black + Gold   | Black + Satin Gray  |
| Schwarz + Schwarz  | Schwarz + Weiß  | Schwarz + Chrom   | Schwarz + Gold   | Schwarz + Satiniert Grau  |
| Noir + Noir  | Noir + Blanc  | Noir + Chrome   | Noir + Or  | Noir + Gris satiné  |
| Negro + Negro  | Negro + Blanco  | Negro + Cromo   | Negro + Dorado   | Negro + Gris Satinado   |
|  |  |  |  |  |
| 1500 W HCA0201010015   | 1500 W HCA0201020015  | 1500 W HCA0201030015  | 1500 W HCA0201040015   | 1500 W HCA0201050015  |
| 2000 W HCA0201010020   | 2000 W HCA0201020020  | 2000 W HCA0201030020  | 2000 W HCA0201040020   | 2000 W HCA0201050020  |

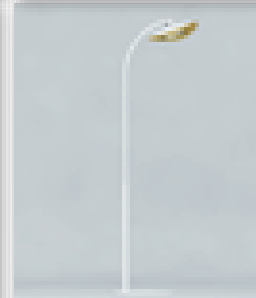
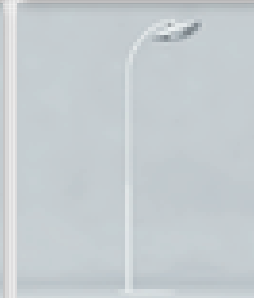
|  |   |   |  |   |
|--|---|---|--|---|
| Bianco + Nero  | Bianco + Bianco   | Bianco + Cromo  | Bianco + Oro   | Bianco + Grigio satinato  |
| White + Black  | White + White   | White + Chrome  | White + Gold   | White + Satin Gray  |
| Weiß + Schwarz   | Weiß + Weiß   | Weiß + Chrom  | Weiß + Gold  | Weiß + Satiniert Grau   |
| Blanc + Noir   | Blanc + Blanc   | Blanc + Chrome  | Blanc + Or   | Blanc + Gris satiné   |
| Blanco + Negro   | Blanco + Blanco   | Blanco + Cromo  | Blanco + Dorado  | Blanco + Gris Satinado  |
|  |  |  |  |  |
| 1500 W HCA0202010015   | 1500 W HCA0202020015  | 1500 W HCA0202030015  | 1500 W HCA0202040015   | 1500 W HCA0202050015  |
| 2000 W HCA0202010020   | 2000 W HCA0202020020  | 2000 W HCA0202030020  | 2000 W HCA0202040020   | 2000 W HCA0202050020  |

Dimensioni / Dimensions /  
Abmessungen / Dimensions  
Dimensiones / mm

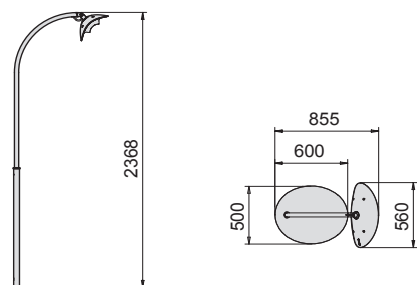

Imballo / Packaging /  
Verpackung / Emballage  
Embalaje / mm

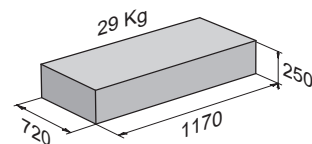

|   |               |   |               |   |               |  |               |   |               |
|---|---------------|---|---------------|---|---------------|--|---------------|---|---------------|
| Nero + Nero   |               | Nero + Bianco   |               | Nero + Cromo  |               | Nero + Oro   |               | Nero + Grigio satinato  |               |
| Black + Black   |               | Black + White   |               | Black + Chrome  |               | Black + Gold   |               | Black + Satin Gray  |               |
| Schwarz + Schwarz   |               | Schwarz + Weiß  |               | Schwarz + Chrom   |               | Schwarz + Gold   |               | Schwarz + Satiniert Grau  |               |
| Noir + Noir   |               | Noir + Blanc  |               | Noir + Chrome   |               | Noir + Or  |               | Noir + Gris satiné  |               |
| Negro + Negro   |               | Negro + Blanco  |               | Negro + Cromo   |               | Negro + Dorado   |               | Negro + Gris Satinado   |               |
|  |               |  |               |  |               |  |               |  |               |
| 1500 W  | HCA0301010015 | 1500 W  | HCA0301020015 | 1500 W  | HCA0301030015 | 1500 W   | HCA0301040015 | 1500 W  | HCA0301050015 |
| 2000 W  | HCA0301010020 | 2000 W  | HCA0301020020 | 2000 W  | HCA0301030020 | 2000 W   | HCA0301040020 | 2000 W  | HCA0301050020 |

|   |               |   |               |   |               |  |               |   |               |
|---|---------------|---|---------------|---|---------------|--|---------------|---|---------------|
| Bianco + Nero   |               | Bianco + Bianco   |               | Bianco + Cromo  |               | Bianco + Oro   |               | Bianco + Grigio satinato  |               |
| White + Black   |               | White + White   |               | White + Chrome  |               | White + Gold   |               | White + Satin Gray  |               |
| Weiß + Schwarz  |               | Weiß + Weiß   |               | Weiß + Chrom  |               | Weiß + Gold  |               | Weiß + Satiniert Grau   |               |
| Blanc + Noir  |               | Blanc + Blanc   |               | Blanc + Chrome  |               | Blanc + Or   |               | Blanc + Gris satiné   |               |
| Blanco + Negro  |               | Blanco + Blanco   |               | Blanco + Cromo  |               | Blanco + Dorado  |               | Blanco + Gris Satinado  |               |
|  |               |  |               |  |               |  |               |  |               |
| 1500 W  | HCA0302010015 | 1500 W  | HCA0302020015 | 1500 W  | HCA0302030015 | 1500 W   | HCA0302040015 | 1500 W  | HCA0302050015 |
| 2000 W  | HCA0302010020 | 2000 W  | HCA0302020020 | 2000 W  | HCA0302030020 | 2000 W   | HCA0302040020 | 2000 W  | HCA0302050020 |

Dimensioni / Dimensions /  
Abmessungen / Dimensions  
Dimensiones / mm

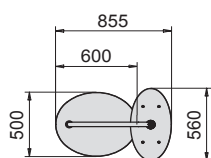
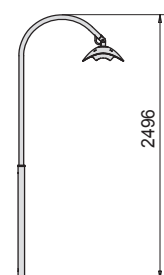

Imballo / Packaging /  
Verpackung / Emballage  
Embalaje / mm

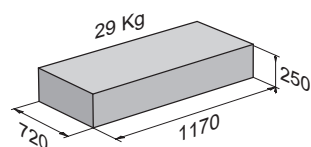

Piantana Singola da tavolo / Floor single stem table lamp / Einzelfußbodenständer für Tisch  
Lampadaire single pour le table / Lámpara de pie para la mesa





Piantana Singola da tavolo / Floor single stem table lamp / Einzelfußbodenständer für Tisch  
Lampadaire single pour le table / Lámpara de pie para la mesa

|   |               |   |               |   |               |  |               |   |               |
|---|---------------|---|---------------|---|---------------|--|---------------|---|---------------|
| Nero + Nero   |               | Nero + Bianco   |               | Nero + Cromo  |               | Nero + Oro   |               | Nero + Grigio satinato  |               |
| Black + Black   |               | Black + White   |               | Black + Chrome  |               | Black + Gold   |               | Black + Satin Gray  |               |
| Schwarz + Schwarz   |               | Schwarz + Weiß  |               | Schwarz + Chrom   |               | Schwarz + Gold   |               | Schwarz + Satiniert Grau  |               |
| Noir + Noir   |               | Noir + Blanc  |               | Noir + Chrome   |               | Noir + Or  |               | Noir + Gris satiné  |               |
| Negro + Negro   |               | Negro + Blanco  |               | Negro + Cromo   |               | Negro + Dorado   |               | Negro + Gris Satinado   |               |
|  |               |  |               |  |               |  |               |  |               |
| 1500 W  | HCB0101010015 | 1500 W  | HCB0101020015 | 1500 W  | HCB0101030015 | 1500 W   | HCB0101040015 | 1500 W  | HCB0101050015 |
| 2000 W  | HCB0101010020 | 2000 W  | HCB0101020020 | 2000 W  | HCB0101030020 | 2000 W   | HCB0101040020 | 2000 W  | HCB0101050020 |

|   |               |   |               |   |               |  |               |   |               |
|---|---------------|---|---------------|---|---------------|--|---------------|---|---------------|
| Bianco + Nero   |               | Bianco + Bianco   |               | Bianco + Cromo  |               | Bianco + Oro   |               | Bianco + Grigio satinato  |               |
| White + Black   |               | White + White   |               | White + Chrome  |               | White + Gold   |               | White + Satin Gray  |               |
| Weiß + Schwarz  |               | Weiß + Weiß   |               | Weiß + Chrom  |               | Weiß + Gold  |               | Weiß + Satiniert Grau   |               |
| Blanc + Noir  |               | Blanc + Blanc   |               | Blanc + Chrome  |               | Blanc + Or   |               | Blanc + Gris satiné   |               |
| Blanco + Negro  |               | Blanco + Blanco   |               | Blanco + Cromo  |               | Blanco + Dorado  |               | Blanco + Gris Satinado  |               |
|  |               |  |               |  |               |  |               |  |               |
| 1500 W  | HCB0102010015 | 1500 W  | HCB0102020015 | 1500 W  | HCB0102030015 | 1500 W   | HCB0102040015 | 1500 W  | HCB0102050015 |
| 2000 W  | HCB0102010020 | 2000 W  | HCB0102020020 | 2000 W  | HCB0102030020 | 2000 W   | HCB0102040020 | 2000 W  | HCB0102050020 |

Dimensioni / Dimensions /  
Abmessungen / Dimensions  
Dimensiones / mm

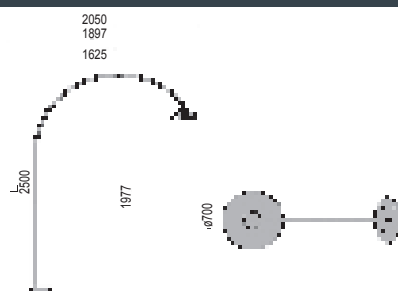



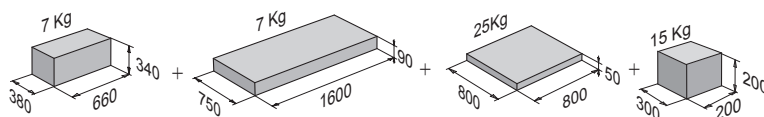

Imballo / Packaging /  
Verpackung / Emballage  
Embalaje / mm



Piantana doppia / Floor double Stem lamp / Doppelfußbodenständer / Lampadaire double  
Lampara de pié doble



|   |               |   |               |   |               |  |               |   |               |
|---|---------------|---|---------------|---|---------------|--|---------------|---|---------------|
| Nero + Nero   |               | Nero + Bianco   |               | Nero + Cromo  |               | Nero + Oro   |               | Nero + Grigio satinato  |               |
| Black + Black   |               | Black + White   |               | Black + Chrome  |               | Black + Gold   |               | Black + Satin Gray  |               |
| Schwarz + Schwarz   |               | Schwarz + Weiß  |               | Schwarz + Chrom   |               | Schwarz + Gold   |               | Schwarz + Satiniert Grau  |               |
| Noir + Noir   |               | Noir + Blanc  |               | Noir + Chrome   |               | Noir + Or  |               | Noir + Gris satiné  |               |
| Negro + Negro   |               | Negro + Blanco  |               | Negro + Cromo   |               | Negro + Dorado   |               | Negro + Gris Satinado   |               |
|  |               |  |               |  |               |  |               |  |               |
| 2x1500 W  | HCA2101010015 | 2x1500 W  | HCA2101020015 | 2x1500 W  | HCA2101030015 | 2x1500 W   | HCA2101040015 | 2x1500 W  | HCA2101050015 |
| 2x2000 W  | HCA2101010020 | 2x2000 W  | HCA2101020020 | 2x2000 W  | HCA2101030020 | 2x2000 W   | HCA2101040020 | 2x2000 W  | HCA2101050020 |

|   |               |   |               |   |               |  |               |   |               |
|---|---------------|---|---------------|---|---------------|--|---------------|---|---------------|
| Bianco + Nero   |               | Bianco + Bianco   |               | Bianco + Cromo  |               | Bianco + Oro   |               | Bianco + Grigio satinato  |               |
| White + Black   |               | White + White   |               | White + Chrome  |               | White + Gold   |               | White + Satin Gray  |               |
| Weiß + Schwarz  |               | Weiß + Weiß   |               | Weiß + Chrom  |               | Weiß + Gold  |               | Weiß + Satiniert Grau   |               |
| Blanc + Noir  |               | Blanc + Blanc   |               | Blanc + Chrome  |               | Blanc + Or   |               | Blanc + Gris satiné   |               |
| Blanco + Negro  |               | Blanco + Blanco   |               | Blanco + Cromo  |               | Blanco + Dorado  |               | Blanco + Gris Satinado  |               |
|  |               |  |               |  |               |  |               |  |               |
| 2x1500 W  | HCA2102010015 | 2x1500 W  | HCA2102020015 | 2x1500 W  | HCA2102030015 | 2x1500 W   | HCA2102040015 | 2x1500 W  | HCA2102050015 |
| 2x2000 W  | HCA2102010020 | 2x2000 W  | HCA2102020020 | 2x2000 W  | HCA2102030020 | 2x2000 W   | HCA2102040020 | 2x2000 W  | HCA2102050020 |

Dimensioni / Dimensions /  
Abmessungen / Dimensions  
Dimensiones / mm

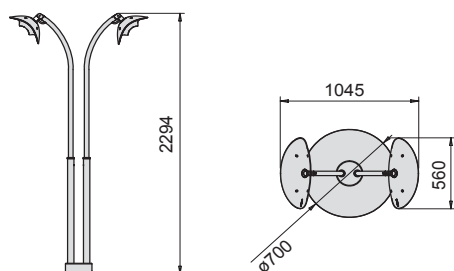



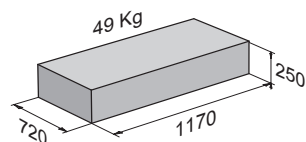

www.phormalab.it

Imballo / Packaging /  
Verpackung / Emballage  
Embalaje / mm

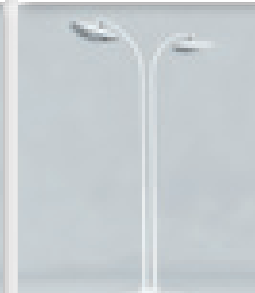

|  |   |   |  |   |
|--|---|---|--|---|
| Nero + Nero  | Nero + Bianco   | Nero + Cromo  | Nero + Oro   | Nero + Grigio satinato  |
| Black + Black  | Black + White   | Black + Chrome  | Black + Gold   | Black + Satin Gray  |
| Schwarz + Schwarz  | Schwarz + Weiß  | Schwarz + Chrom   | Schwarz + Gold   | Schwarz + Satiniert Grau  |
| Noir + Noir  | Noir + Blanc  | Noir + Chrome   | Noir + Or  | Noir + Gris satiné  |
| Negro + Negro  | Negro + Blanco  | Negro + Cromo   | Negro + Dorado   | Negro + Gris Satinado   |
|  |  |  |  |  |
| 2x1500 W HCA2201010015   | 2x1500 W HCA2201020015  | 2x1500 W HCA2201030015  | 2x1500 W HCA2201040015   | 2x1500 W HCA2201050015  |
| 2x2000 W HCA2201010020   | 2x2000 W HCA2201020020  | 2x2000 W HCA2201030020  | 2x2000 W HCA2201040020   | 2x2000 W HCA2201050020  |



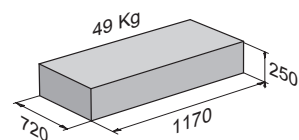
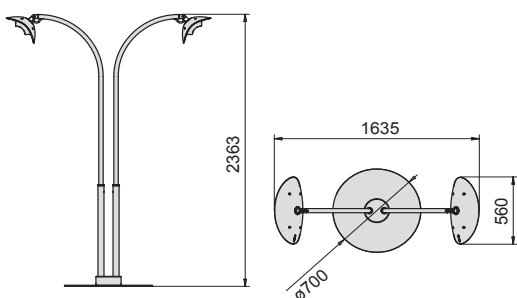

|  |   |   |  |   |
|--|---|---|--|---|
| Bianco + Nero  | Bianco + Bianco   | Bianco + Cromo  | Bianco + Oro   | Bianco + Grigio satinato  |
| White + Black  | White + White   | White + Chrome  | White + Gold   | White + Satin Gray  |
| Weiß + Schwarz   | Weiß + Weiß   | Weiß + Chrom  | Weiß + Gold  | Weiß + Satiniert Grau   |
| Blanc + Noir   | Blanc + Blanc   | Blanc + Chrome  | Blanc + Or   | Blanc + Gris satiné   |
| Blanco + Negro   | Blanco + Blanco   | Blanco + Cromo  | Blanco + Dorado  | Blanco + Gris Satinado  |
|  |  |  |  |  |
| 2x1500 W HCA2202010015   | 2x1500 W HCA2202020015  | 2x1500 W HCA2202030015  | 2x1500 W HCA2202040015   | 2x1500 W HCA2202050015  |
| 2x2000 W HCA2202010020   | 2x2000 W HCA2202020020  | 2x2000 W HCA2202030020  | 2x2000 W HCA2202040020   | 2x2000 W HCA2202050020  |

Dimensioni / Dimensions /  
Abmessungen / Dimensions  
Dimensiones / mm

Imballo / Packaging /  
Verpackung / Emballage  
Embalaje / mm

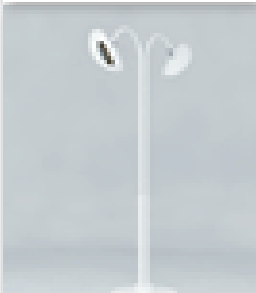

|   |               |   |               |   |               |  |               |   |               |
|---|---------------|---|---------------|---|---------------|--|---------------|---|---------------|
| Nero + Nero   |               | Nero + Bianco   |               | Nero + Cromo  |               | Nero + Oro   |               | Nero + Grigio satinato  |               |
| Black + Black   |               | Black + White   |               | Black + Chrome  |               | Black + Gold   |               | Black + Satin Gray  |               |
| Schwarz + Schwarz   |               | Schwarz + Weiß  |               | Schwarz + Chrom   |               | Schwarz + Gold   |               | Schwarz + Satiniert Grau  |               |
| Noir + Noir   |               | Noir + Blanc  |               | Noir + Chrome   |               | Noir + Or  |               | Noir + Gris satiné  |               |
| Negro + Negro   |               | Negro + Blanco  |               | Negro + Cromo   |               | Negro + Dorado   |               | Negro + Gris Satinado   |               |
|  |               |  |               |  |               |  |               |  |               |
| 2x1500 W  | HCA2301010015 | 2x1500 W  | HCA2301020015 | 2x1500 W  | HCA2301030015 | 2x1500 W   | HCA2301040015 | 2x1500 W  | HCA2301050015 |
| 2x2000 W  | HCA2301010020 | 2x2000 W  | HCA2301020020 | 2x2000 W  | HCA2301030020 | 2x2000 W   | HCA2301040020 | 2x2000 W  | HCA2301050020 |

|   |               |   |               |   |               |  |               |   |               |
|---|---------------|---|---------------|---|---------------|--|---------------|---|---------------|
| Bianco + Nero   |               | Bianco + Bianco   |               | Bianco + Cromo  |               | Bianco + Oro   |               | Bianco + Grigio satinato  |               |
| White + Black   |               | White + White   |               | White + Chrome  |               | White + Gold   |               | White + Satin Gray  |               |
| Weiß + Schwarz  |               | Weiß + Weiß   |               | Weiß + Chrom  |               | Weiß + Gold  |               | Weiß + Satiniert Grau   |               |
| Blanc + Noir  |               | Blanc + Blanc   |               | Blanc + Chrome  |               | Blanc + Or   |               | Blanc + Gris satiné   |               |
| Blanco + Negro  |               | Blanco + Blanco   |               | Blanco + Cromo  |               | Blanco + Dorado  |               | Blanco + Gris Satinado  |               |
|  |               |  |               |  |               |  |               |  |               |
| 2x1500 W  | HCA2302010015 | 2x1500 W  | HCA2302020015 | 2x1500 W  | HCA2302030015 | 2x1500 W   | HCA2302040015 | 2x1500 W  | HCA2302050015 |
| 2x2000 W  | HCA2302010020 | 2x2000 W  | HCA2302020020 | 2x2000 W  | HCA2302030020 | 2x2000 W   | HCA2302040020 | 2x2000 W  | HCA2302050020 |

Dimensioni / Dimensions /  
Abmessungen / Dimensions  
Dimensiones / mm

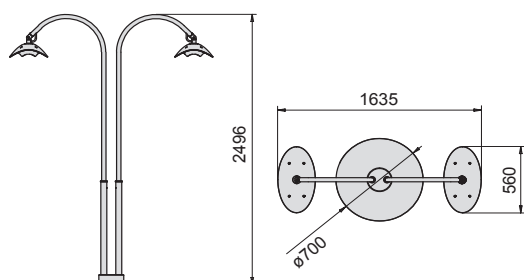



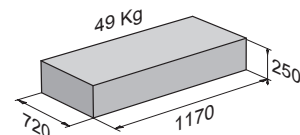

Imballo / Packaging /  
Verpackung / Emballage  
Embalaje / mm





|   |               |   |               |   |               |  |               |   |               |
|---|---------------|---|---------------|---|---------------|--|---------------|---|---------------|
| Nero + Nero   |               | Nero + Bianco   |               | Nero + Cromo  |               | Nero + Oro   |               | Nero + Grigio satinato  |               |
| Black + Black   |               | Black + White   |               | Black + Chrome  |               | Black + Gold   |               | Black + Satin Gray  |               |
| Schwarz + Schwarz   |               | Schwarz + Weiß  |               | Schwarz + Chrom   |               | Schwarz + Gold   |               | Schwarz + Satiniert Grau  |               |
| Noir + Noir   |               | Noir + Blanc  |               | Noir + Chrome   |               | Noir + Or  |               | Noir + Gris satiné  |               |
| Negro + Negro   |               | Negro + Blanco  |               | Negro + Cromo   |               | Negro + Dorado   |               | Negro + Gris Satinado   |               |
|  |               |  |               |  |               |  |               |  |               |
| 1500 W  | HBA0101010015 | 1500 W  | HBA0101020015 | 1500 W  | HBA0101030015 | 1500 W   | HBA0101040015 | 1500 W  | HBA0101050015 |
| 2000 W  | HBA0101010020 | 2000 W  | HBA0101020020 | 2000 W  | HBA0101030020 | 2000 W   | HBA0101040020 | 2000 W  | HBA0101050020 |

|   |               |   |               |   |               |  |               |   |               |
|---|---------------|---|---------------|---|---------------|--|---------------|---|---------------|
| Bianco + Nero   |               | Bianco + Bianco   |               | Bianco + Cromo  |               | Bianco + Oro   |               | Bianco + Grigio satinato  |               |
| White + Black   |               | White + White   |               | White + Chrome  |               | White + Gold   |               | White + Satin Gray  |               |
| Weiß + Schwarz  |               | Weiß + Weiß   |               | Weiß + Chrom  |               | Weiß + Gold  |               | Weiß + Satiniert Grau   |               |
| Blanc + Noir  |               | Blanc + Blanc   |               | Blanc + Chrome  |               | Blanc + Or   |               | Blanc + Gris satiné   |               |
| Blanco + Negro  |               | Blanco + Blanco   |               | Blanco + Cromo  |               | Blanco + Dorado  |               | Blanco + Gris Satinado  |               |
|  |               |  |               |  |               |  |               |  |               |
| 1500 W  | HBA0102010015 | 1500 W  | HBA0102020015 | 1500 W  | HBA0102030015 | 1500 W   | HBA0102040015 | 1500 W  | HBA0102050015 |
| 2000 W  | HBA0102010020 | 2000 W  | HBA0102020020 | 2000 W  | HBA0102030020 | 2000 W   | HBA0102040020 | 2000 W  | HBA0102050020 |



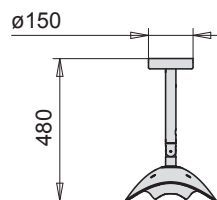
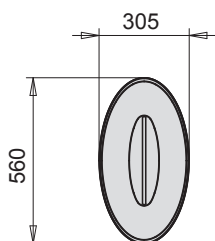

Dimensioni / Dimensions /  
Abmessungen / Dimensions  
Dimensiones / mm

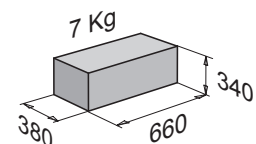

Imballo / Packaging /  
Verpackung / Emballage  
Embalaje / mm



**Attacco doppio / Double mounting / Doppeldeckenhalterung / Plafonnier double**  
**Soporte doble**

|  |               |   |               |   |               |  |               |   |               |
|--|---------------|---|---------------|---|---------------|--|---------------|---|---------------|
| Nero + Nero  |               | Nero + Bianco   |               | Nero + Cromo  |               | Nero + Oro   |               | Nero + Grigio satinato  |               |
| Black + Black  |               | Black + White   |               | Black + Chrome  |               | Black + Gold   |               | Black + Satin Gray  |               |
| Schwarz + Schwarz  |               | Schwarz + Weiß  |               | Schwarz + Chrom   |               | Schwarz + Gold   |               | Schwarz + Satiniert Grau  |               |
| Noir + Noir  |               | Noir + Blanc  |               | Noir + Chrome   |               | Noir + Or  |               | Noir + Gris satiné  |               |
| Negro + Negro  |               | Negro + Blanco  |               | Negro + Cromo   |               | Negro + Dorado   |               | Negro + Gris Satinado   |               |
|  |               |  |               |  |               |  |               |  |               |
| 2x1500 W   | HBA2101010015 | 2x1500 W  | HBA2101020015 | 2x1500 W  | HBA2101030015 | 2x1500 W   | HBA2101040015 | 2x1500 W  | HBA2101050015 |
| 2x2000 W   | HBA2101010020 | 2x2000 W  | HBA2101020020 | 2x2000 W  | HBA2101030020 | 2x2000 W   | HBA2101040020 | 2x2000 W  | HBA2101050020 |

|  |               |   |               |   |               |  |               |   |               |
|--|---------------|---|---------------|---|---------------|--|---------------|---|---------------|
| Bianco + Nero  |               | Bianco + Bianco   |               | Bianco + Cromo  |               | Bianco + Oro   |               | Bianco + Grigio satinato  |               |
| White + Black  |               | White + White   |               | White + Chrome  |               | White + Gold   |               | White + Satin Gray  |               |
| Weiß + Schwarz   |               | Weiß + Weiß   |               | Weiß + Chrom  |               | Weiß + Gold  |               | Weiß + Satiniert Grau   |               |
| Blanc + Noir   |               | Blanc + Blanc   |               | Blanc + Chrome  |               | Blanc + Or   |               | Blanc + Gris satiné   |               |
| Blanco + Negro   |               | Blanco + Blanco   |               | Blanco + Cromo  |               | Blanco + Dorado  |               | Blanco + Gris Satinado  |               |
|  |               |  |               |  |               |  |               |  |               |
| 2x1500 W   | HBA2102010015 | 2x1500 W  | HBA2102020015 | 2x1500 W  | HBA2102030015 | 2x1500 W   | HBA2102040015 | 2x1500 W  | HBA2102050015 |
| 2x2000 W   | HBA2102010020 | 2x2000 W  | HBA2102020020 | 2x2000 W  | HBA2102030020 | 2x2000 W   | HBA2102040020 | 2x2000 W  | HBA2102050020 |

Dimensioni / Dimensions /  
 Abmessungen / Dimensions  
 Dimensiones / mm

Imballo / Packaging /  
 Verpackung / Emballage  
 Embalaje / mm

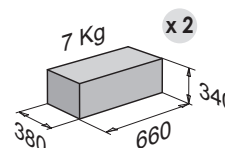
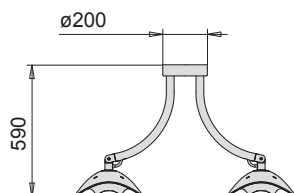
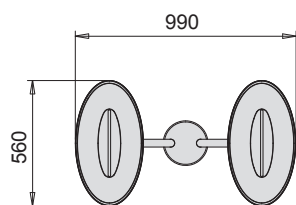





ACCESSORI E RICAMBI

ACCESSORIES AND SPARE PARTS

ZUBEHÖRE UND ERSATZTEILE

ACCESSOIRES ET PIÈCES DE RECHANGE

ACCESORIOS Y PIEZAS DE RECAMBIO

|   |
|---|
| Ricevitore wireless per riscaldatori infrarossi fino a 2000W                      |
| Wireless receiver for infrared heaters up to 2000W                                |
| Wireless Empfänger für Infrarot-Strahler bis 2000W                                |
| Récepteur sans fil pour rechauffeurs infrarouge jusqu'à 2000W                     |
| Receptor sin hilo por calefactor infrarrojos hasta 2000W                          |
|  |
| DIM01   |

|   |
|---|
| Ricevitore wireless per riscaldatori infrarossi fino a 6500W                      |
| Wireless receiver for infrared heaters up to 6500W                                |
| Wireless Empfänger für Infrarot-Strahler bis 6500W                                |
| Récepteur sans fil pour rechauffeurs infrarouge jusqu'à 6500W                     |
| Receptor sin hilo por calefactor infrarrojos hasta 6500W                          |
|  |
| DIM02   |

|  |   |   |
|--|---|---|
| Alimentazione<br>Power supply<br>Stromzufuhr<br>Alimentation<br>Alimentación                                   | DIM01<br><b>230V</b>  | DIM02<br><b>230V</b>  |
| Livelli di funzione<br>Operating levels<br>Laufstufen<br>Niveaux de fonction<br>Niveles de función             | <b>off</b><br><b>50%</b><br><b>66%</b><br><b>100%</b>         | <b>off</b><br><b>50%</b><br><b>66%</b><br><b>100%</b>         |
| Temperatura min/max<br>Temperature min/max<br>Temperatur min/max<br>Temperature min/max<br>Temperatura min/max | <b>-20° C</b><br><b>+50° C</b>                                | <b>-20° C</b><br><b>+50° C</b>                                |
| Grado di protezione<br>Degree of protection<br>Schutzstufe<br>Degré de protection<br>Grado de protección       | <b>IP54</b>   | <b>IP54</b>   |
| Dimensioni mm<br>Sizes mm<br>Maße mm<br>Dimensions mm<br>Dimensiones mm  | <b>145</b><br><b>x</b><br><b>115</b><br><b>x</b><br><b>55</b> | <b>195</b><br><b>x</b><br><b>200</b><br><b>x</b><br><b>75</b> |

Collegamento del dimmer al cavo di alimentazione  
Connection of dimmer to power supply cable  
Anschluß des Dimmers an dem Stromkabel  
Connexion du dimmer au cable d'alimentation  
Conexión del dimmer al cable de alimentación

|       |                                      |  |                                      |  |
|-------|--------------------------------------|--|--------------------------------------|--|
|       | un - one - ein<br>un - un<br>1 DIM01 | 2 o più - 2 or more<br>2 oder mehr<br>2 ou plus<br>DIM01 | un - one - ein<br>un - un<br>1 DIM02 | 2 o più - 2 or more<br>2 oder mehr<br>2 ou plus<br>DIM02 |
| TEL01 | □                                    | ●  | ●                                    | ●  |
| TEL03 | □                                    | ●  | ●                                    | ●  |
| TEL04 | ×                                    | ★  | ★                                    | ★  |
| WIF01 | □                                    | ▲  | ▲                                    | ▲  |



□ OFF - 50% - 66% - 100%  
Regolazione della potenza  
Power Dimmer - Leistungsstufen  
Réglage de la puissance  
Regulación de potencia

● OFF - 50% - 66% - 100%  
Regolazione della potenza identica per tutti gli apparecchi - No separate control of the heaters - Gleiche Einstellung für alle Geräte - Même réglage pour tous les appareils - Misma regulación para todos los dispositivos

★ OFF - 50% - 66% - 100% - Regolazione separata per ogni apparecchio (fino a 7) - Separate control of the heaters (up to 7) - Getrennte Einstellung für jedes - Geräte (bis 7)  
Réglage séparé pour chaque dispositif (jusqu'a 7) - Control separado para cada dispositivo (hasta 7)

▲ OFF - 50% - 66% - 100% - Regolazione separata per ogni apparecchio (fino a 24) - Separate control of the heaters (up to 24) - Getrennte Einstellung für jedes Geräte (bis 24)  
Réglage séparé pour chaque dispositif (jusqu'a 7) - Control separado para cada dispositivo (hasta 24)

× Non disponibile - Not available - Unverfügbar - Indisponible

|  |  |   |  |
|--|--|---|--|
| Telecomando<br>Remote control switch<br>Fernbedienung<br>Télécommande<br>Mando a distancia | Telecomando a parete<br>Wall remote control switch<br>Wand-Fernbedienung<br>Télécommande mural<br>Telecomando de pared | Telecomando multiplo<br>Multiple remote control<br>Mehrere Fernbedienung<br>Télécommande multiple<br>Mando a distancia múltiple | Sistema di controllo WI-FI per PC e Smartphone<br>WI-Fi Control System for PC and smartphone<br>Steuerungslösung WI-FI für PC oder Smartphone<br>Système de contrôle WI-Fi par PC et Smartphone<br>Sistema de control WI-Fi para PC y Smartphone |
|         |                                     |   |   |
| TEL01  | TEL 03   | TEL 04  | WIF01  |

**Corpo lampada - Scocche Anteriori / Heater Body and Covers / Strahler Körper -  
Vorabdeckungen / Corps lampe - Couvercle antérieur / Cuerpo lámpara - Tapas anteriores**

|   |  |
|---|--|
| Presa ON/OFF con telecomando per prese fino a 3500W                               |  |
| Plug ON/OFF with remote control switch for plug up to 3500W                       |  |
| Stecker ON/OFF mit fernbedienung für Stecker bis 3500W                            |  |
| Prise ON/OFF avec Télécommande pour prise jusqu'à 3500W                           |  |
| Enchufe ON/OFF con Mando a distancia ON/OFF para enchufe hasta 3500W              |  |
|  |  |
| INTO1 + TEL02   |  |

|  |  |
|--|--|
| Carrello spostamento lampada a piantana  |  |
| Trolley for stem-foot heaters move   |  |
| Laufwagen für Fußbodenständer  |  |
| Chariot de déplacements pour lampadaires   |  |
| Carro de desplazamiento para lámparas de pie                                       |  |
|  |  |
| CAR01  |  |

|   |          |
|---|----------|
| Snodo - Joint Gelenk - Joint - Junta  |          |
| Nero  | Bianco   |
| Black   | White    |
| Schwarz   | Weiß     |
| Noir  | Blanc    |
| Negro   | Blanco   |
|  |          |
| PUR3699N  | PUR3699B |

|   |               |
|---|---------------|
| Nero  | Bianco        |
| Black   | White         |
| Schwarz   | Weiß          |
| Noir  | Blan          |
| Negro   | Blanco        |
|  |               |
| HXX0001000000   | HXX0002000000 |

|  |          |
|--|----------|
| Nero   | Bianco   |
| Black  | White    |
| Schwarz  | Weiß     |
| Noir   | Blan     |
| Negro  | Blanco   |
|  |          |
| PUR0299N   | PUR0299B |

|   |  |
|---|--|
| Cromo - Oro Grigio satinato   |  |
| Chrome - Gold Satin Gray  |  |
| Chrom - Gold Satiniert Grau   |  |
| Chrome - Or Gris satiné   |  |
| Cromo - Dorado Gris satinado  |  |
|  |  |
| PUR0299C - PUR0299O - PUR0299S  |  |

|         |        |
|---------|--------|
| Nero    | Bianco |
| Black   | White  |
| Schwarz | Weiß   |
| Noir    | Blanc  |
| Negro   | Blanco |

|         |         |
|---------|---------|
| HAA0101 | HAA0102 |
|---------|---------|

|         |        |
|---------|--------|
| Nero    | Bianco |
| Black   | White  |
| Schwarz | Weiß   |
| Noir    | Blanc  |
| Negro   | Blanco |

|         |         |
|---------|---------|
| HBA0101 | HBA0102 |
|---------|---------|

|         |        |
|---------|--------|
| Nero    | Bianco |
| Black   | White  |
| Schwarz | Weiß   |
| Noir    | Blanc  |
| Negro   | Blanco |

|         |         |
|---------|---------|
| HBA2101 | HBA2102 |
|---------|---------|

|         |        |
|---------|--------|
| Nero    | Bianco |
| Black   | White  |
| Schwarz | Weiß   |
| Noir    | Blanc  |
| Negro   | Blanco |

|         |         |
|---------|---------|
| HAA1101 | HAA1102 |
|---------|---------|

|         |        |
|---------|--------|
| Nero    | Bianco |
| Black   | White  |
| Schwarz | Weiß   |
| Noir    | Blanc  |
| Negro   | Blanco |

|         |         |
|---------|---------|
| HAA1201 | HAA1202 |
|---------|---------|

|         |        |
|---------|--------|
| Nero    | Bianco |
| Black   | White  |
| Schwarz | Weiß   |
| Noir    | Blanc  |
| Negro   | Blanco |

|         |         |
|---------|---------|
| HAA1301 | HAA1302 |
|---------|---------|

Piantane con stelo singolo e doppio / Single and double Floor Stems / Einzel- und Doppelständer  
 Tiges singles et doubles / Soportes de barra de pie individuales y dobles

|         |        |
|---------|--------|
| Nero    | Bianco |
| Black   | White  |
| Schwarz | Weiß   |
| Noir    | Blanc  |
| Negro   | Blanco |

|         |         |
|---------|---------|
| HCA0101 | HCA0102 |
|---------|---------|

|         |        |
|---------|--------|
| Nero    | Bianco |
| Black   | White  |
| Schwarz | Weiß   |
| Noir    | Blanc  |
| Negro   | Blanco |

|         |         |
|---------|---------|
| HCA0201 | HCA0202 |
|---------|---------|

|         |        |
|---------|--------|
| Nero    | Bianco |
| Black   | White  |
| Schwarz | Weiß   |
| Noir    | Blanc  |
| Negro   | Blanco |

|         |         |
|---------|---------|
| HCA0301 | HCA0302 |
|---------|---------|

|         |        |
|---------|--------|
| Nero    | Bianco |
| Black   | White  |
| Schwarz | Weiß   |
| Noir    | Blanc  |
| Negro   | Blanco |

|         |         |
|---------|---------|
| HCB0101 | HCB0102 |
|---------|---------|

|         |        |
|---------|--------|
| Nero    | Bianco |
| Black   | White  |
| Schwarz | Weiß   |
| Noir    | Blanc  |
| Negro   | Blanco |



|         |         |
|---------|---------|
| HCA2101 | HCA2102 |
|---------|---------|



|         |        |
|---------|--------|
| Nero    | Bianco |
| Black   | White  |
| Schwarz | Weiß   |
| Noir    | Blanc  |
| Negro   | Blanco |



|         |         |
|---------|---------|
| HCA2201 | HCA2202 |
|---------|---------|

|         |        |
|---------|--------|
| Nero    | Bianco |
| Black   | White  |
| Schwarz | Weiß   |
| Noir    | Blanc  |
| Negro   | Blanco |

|         |         |
|---------|---------|
| HCA2301 | HCA2302 |
|---------|---------|



|   |   |
|---|---|
| Nero  | Bianco  |
| Black   | White   |
| Schwarz   | Weiß  |
| Noir  | Blanc   |
| Negro   | Blanco  |
|  |  |
| PUR1599N  | PUR1599B  |

|   |   |
|---|---|
| Nero  | Bianco  |
| Black   | White   |
| Schwarz   | Weiß  |
| Noir  | Blanc   |
| Negro   | Blanco  |
|  |  |
| PUR2099N  | PUR2099B  |

|   |   |
|---|---|
| Nero  | Bianco  |
| Black   | White   |
| Schwarz   | Weiß  |
| Noir  | Blanc   |
| Negro   | Blanco  |
|  |  |
| PUR44N  | PUR44B  |





|   |   |
|---|---|
| Nero  | Bianco  |
| Black   | White   |
| Schwarz   | Weiß  |
| Noir  | Blanc   |
| Negro   | Blanco  |
|  |  |
| PUR43N  | PUR43B  |

|   |   |
|---|---|
| Nero  | Bianco  |
| Black   | White   |
| Schwarz   | Weiß  |
| Noir  | Blanc   |
| Negro   | Blanco  |
|  |  |
| PUR45N  | PUR45B  |

|   |   |
|---|---|
| Nero  | Bianco  |
| Black   | White   |
| Schwarz   | Weiß  |
| Noir  | Blanc   |
| Negro   | Blanco  |
|  |  |
| PUR1499N  | PUR1499B  |

**Ricambi elettrici / Electrical Spare Parts / Elektrische Ersatzteile /  
Pièces de rechange électriques / Piezas electricas de recambio**

|   |        |        |   |  |  |   |  |  |
|---|--------|--------|---|--|--|---|--|--|
| Spina Schuko con cavo nero<br>3x1.5mm <sup>2</sup> <b>(3-5-10 mt)</b>             |        |        | Spina UK con cavo nero<br>3x1.5mm <sup>2</sup> <b>(5 mt)</b>                      |  |  | Spina CH con cavo nero<br>3x1.5mm <sup>2</sup> <b>(5 mt)</b>                        |  |  |
| Schuko plug with 3x1.5mm <sup>2</sup><br>black cable <b>(3-5-10 mt)</b>           |        |        | UK plug with 3x1.5mm <sup>2</sup><br>black cable <b>(5 mt)</b>                    |  |  | CH plug with 3x1.5mm <sup>2</sup><br>black cable <b>(5 mt)</b>                      |  |  |
| Schuko Stecker mit 3x1.5mm <sup>2</sup><br>schwarzem Kabel <b>(3-5-10 mt)</b>     |        |        | UK Stecker mit 3x1.5mm <sup>2</sup><br>schwarzem Kabel <b>(5 mt)</b>              |  |  | CH Stecker mit 3x1.5mm <sup>2</sup><br>schwarzem Kabel <b>(5 mt)</b>                |  |  |
| Fiche Schuko avec câble noir<br>3x1.5mm <sup>2</sup> <b>(3-5-10 mt)</b>           |        |        | Fiche UK avec câble noir<br>3x1.5mm <sup>2</sup> <b>(5 mt)</b>                    |  |  | Fiche CH avec câble noir<br>3x1.5mm <sup>2</sup> <b>(5 mt)</b>                      |  |  |
| Cable con enchufe Schuko negro<br>3x1.5mm <sup>2</sup> <b>(3-5-10 mt)</b>         |        |        | Cable con enchufe UK negro<br>3x1.5mm <sup>2</sup> <b>(5 mt)</b>                  |  |  | Cable con enchufe CH negro<br>3x1.5mm <sup>2</sup> <b>(5 mt)</b>                    |  |  |
|  |        |        |  |  |  |  |  |  |
| SC0103  | SC0105 | SC0110 | SC0105  |  |  | SC0110  |  |  |

|   |            |            |   |            |        |  |  |        |   |  |  |
|---|------------|------------|---|------------|--------|--|--|--------|---|--|--|
| Lampadina a raggi infrarossi  |            |            | Lampadina a raggi infrarossi<br>a ridotta emissione luminosa                        |            |        | <b>3 poli IP 68</b>  |  |        | <b>3 poli IP 68</b>   |  |  |
| Infrared Bulb   |            |            | Infrared Low Glare Bulb   |            |        | <b>IP 68 3 poles</b><br>Linear connector   |  |        | <b>IP 68 3 poles</b><br>T-connector   |  |  |
| Infrarot Heizelement  |            |            | Infrarot Heizelement mit<br>reduziertem Lichtausstoß                                |            |        | <b>IP 68 3-polig</b><br>Linearverbinder  |  |        | <b>IP 68 3-polig</b><br>T-Verbinder   |  |  |
| Ampoule à infrarouge  |            |            | Ampoule à infrarouge<br>avec luminosité réduite                                     |            |        | Connecteur linéaire<br>avec <b>3 pôles IP 68</b>                                     |  |        | Connecteur en T<br>avec <b>3 pôles IP 68</b>  |  |  |
| Bombilla Infrarrojos  |            |            | Bombilla de baja<br>luminosidad   |            |        | Conector linear<br><b>3 polos IP 68</b>  |  |        | Conector T<br><b>3 polos IP 68</b>  |  |  |
|  |            |            |  |            |        |  |  |        |  |  |  |
| 1500W-230V  | 2000W-230V | 1500W-110V | 1500W-230V  | 2000W-230V | CL0101 |  |  | CT0101 |   |  |  |
| BUL02   | BUL03      | BUL04      | BUL05   | BUL06      |        |  |  |        |   |  |  |

HAA01  
 HBA01

HAA11  
 HAA12  
 HBA13

HCA01  
 HCA02  
 HCA03



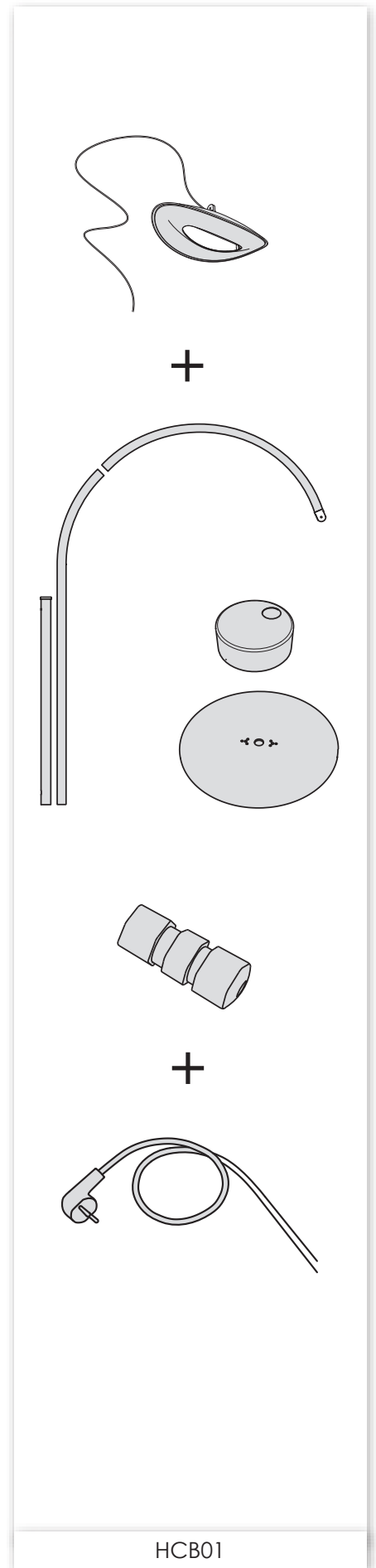
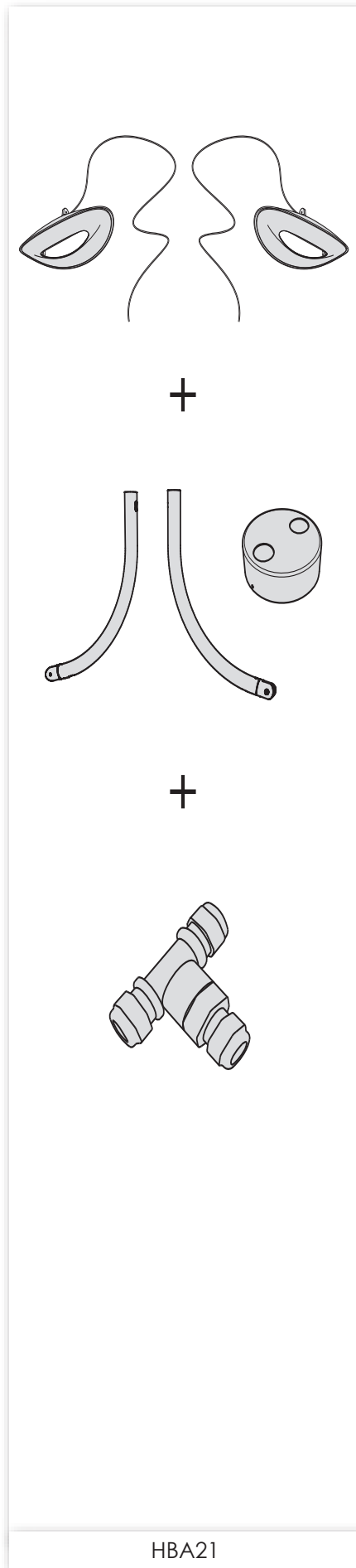
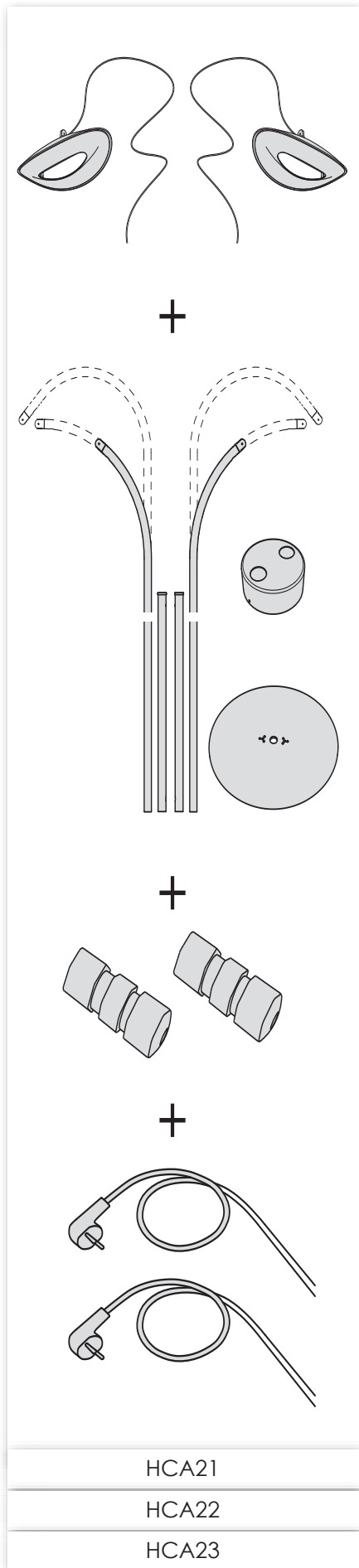

## CONDIZIONI GENERALI DI VENDITA



01. Le presenti condizioni generali di vendita si intendono integralmente accettate dal cliente con il conferimento dell'ordine.
02. Gli ordini o gli impegni assunti dai nostri rappresentanti sono validi unicamente dopo nostra accettazione o conferma scritta.
03. I dati, le misure, gli articoli, i prezzi, le caratteristiche, le prestazioni e tutti gli altri dati riprodotti nei nostri cataloghi, listini, prospetti, circolari ecc. hanno carattere indicativo; essi possono essere variati senza alcun preavviso, e hanno valore vincolante per noi unicamente in caso di espressa indicazione nell'accettazione o nella conferma.
04. Eventuali reclami o contestazioni non daranno in alcun caso diritto al cliente di omettere o ritardare i pagamenti della fornitura. Per essere validi i reclami dovranno pervenirci entro 8 giorni dalla data di ricevimento della merce.
05. Il cliente non potrà restituire per alcuna ragione materiale senza nostra espressa autorizzazione scritta. In caso di forza maggiore, ci riserviamo la facoltà di sospendere le consegne e anche di annullare ordini debitamente accettati senza che ciò possa dare diritto al cliente di chiedere qualsivoglia indennizzo o risarcimento danni.
06. Eventuali ritardi nelle consegne non daranno diritto al cliente ad indennizzi e/o risarcimento danni. Le consegne anche se parziali di merce non possono essere rifiutate dal cliente e non danno diritto all'annullamento dell'ordine.
07. La resa del materiale s'intende effettuata sempre "franco partenza". Ogni nostra responsabilità cessa con la consegna al cliente od al vettore e quindi il materiale viaggia a rischio e pericolo del cliente. Nei casi in cui, per accordi specifici intervenuti con il cliente, il materiale sia venduto "franco destino" non verranno comunque accettate contestazioni per eventuali furti, rotture o manomissioni. Eventuali accordi con spedizionieri, ivi compreso l'ammontare ed il pagamento del prezzo del trasporto, s'intenderanno sempre conclusi in nome e per conto del cliente che sin d'ora accetta e ratifica il nostro operato.
08. Tutti i nostri prodotti vengono accuratamente collaudati in stabilimento; essi sono pertanto coperti da garanzia dai difetti di fabbricazione per un periodo di due anni dalla data di emissione della fattura o della ricevuta fiscale emessa dal rivenditore.
09. La ditta produttrice s'impegna a riparare o sostituire gratuitamente quelle parti che entro il periodo di garanzia, si dimostrassero difettose di fabbricazione. Difetti non chiaramente attribuibili al materiale o alla fabbricazione verranno esaminati presso il nostro centro di assistenza tecnica e addebitati a seconda dell'esito della verifica. Sono comunque esclusi dalla garanzia: i danni accidentali per trasporto, per incuria, per uso ed installazione errati o non conformi alle avvertenze riportate sul libretto di istruzioni. La garanzia decade qualora l'apparecchio sia stato manomesso o riparato da terzi non autorizzati. In questi casi è esclusa la sostituzione dell'apparecchio ed il prolungamento della garanzia a seguito di intervenuto guasto. Le riparazioni vengono eseguite presso il nostro centro di assistenza tecnica autorizzato; la merce da riparare o sostituire in garanzia deve pervenire presso il centro in porto franco, cioè con spese di trasporto a carico del cliente.
10. Decliniamo ogni responsabilità per eventuali danni a persone, animali o cose derivanti dall'utilizzo degli apparecchi senza osservanza delle prescrizioni di sicurezza o comunque non installati correttamente e/o installati senza effettuare i controlli d'uso.
11. I prezzi riportati sul listino si intendono al netto di IVA.
12. Per qualsiasi controversia derivante da nostra vendita, il contratto sarà disciplinato dalla Legge Italiana, e la competenza sarà unicamente del Foro di Brescia.

## GENERAL SALES CONDITIONS



01. These general sales conditions are considered fully accepted by the customer upon confirmation of the order.
02. The orders and commitments undertaken by our representatives are only valid following our written acceptance or confirmation.
03. The data, measurements, articles, prices, features, performance and all other data shown in our catalogues, price lists, prospectuses, circulars etc. are given as an indication only; they may be changed without any warning and are only considered binding for us in the event of their explicit mention in the acceptance or confirmation.
04. Under no circumstances will any complaints or disputes give the customer any right to omit or delay payments for the delivery. In order for them to be valid, complaints must reach us within 8 days of receipt of the goods.
05. The customer cannot return the material for any reason without our explicit

- written authorization. In the event of majeure force, we reserve the right to suspend deliveries and even to cancel duly accepted orders without the customer having any right to ask for any type of compensation or damages.
06. Any delays in deliveries will not give the customer the right to compensation and/or damages. Deliveries of goods, even if partial, cannot be refused by the customer and do not give the customer the right to cancel the order.
  07. The delivery of material is considered ex works. All our responsibility ceases with delivery to the customer or courier and therefore the material is transported at the customer's own risk. In cases in which, due to specific customer interventions, the material is sold delivered to destination, no disputes will be accepted for any thefts, breakages or tampering. Any agreements with forwarding agents, including the amount and payment of the cost of transportation are considered settled in the name of and on behalf of the customer who from this moment onwards accepts and approves our conduct.
  08. All our products are carefully tested in our factory, and they are therefore warranted against manufacturing defects for a period of two years from the date of issue of our invoice or from the receipt (or other sale document) issued by the dealer.
  09. The manufacturer undertakes to repair or replace free of charge any parts that within the warranty period should show manufacturing defects. Defects not clearly imputable to materials or making, will be examined by our customer service and charged to the customer according to the results of the inspection. Accidental damage due to transport, due to neglect or incorrect installation or use, or not in compliance with the instructions or warnings contained in our installation hand-book are excluded from the guarantee: The warranty fails if our product has been tampered with or repaired by unauthorized people, and the replacement of the product and the extension of guarantee after occurred failure is excluded. Repairs are carried out by our authorized customer service. The goods to be repaired or replaced under warranty must be received by our customer service free of charge including transport.
  10. We refuse all responsibility for any damage or injury to persons, animals or things deriving from the use of the appliances without observing the safety provisions or from appliances which are not installed correctly and/or have been installed without performing user checks.
  11. The prices shown in the price list do not include VAT.
  12. For any controversy deriving from our sale, the contract will be regulated by Italian Law and the Court of Brescia will have sole competence.

## ALLGEMEINE VERKAUFSBEDINGUNGEN



01. Die vorliegenden allgemeinen Verkaufsbedingungen werden mit der erbrachten Auftragsabgabe von dem Kunden vollständig akzeptiert.
02. Die durch unsere Vertreter angenommenen Aufträge oder Verpflichtungen sind nur dann gültig, wenn sie von uns schriftlich akzeptiert oder bestätigt wurden.
03. Die Größen, Artikel, Preise, Eigenschaften, Leistungen und alle anderen Auskünfte aus unseren Katalogen, Preislisten, Prospekten, Rundschreiben usw. sind Richtdaten; sie können ohne Vorankündigung geändert werden und sind für uns nur im Falle eines ausdrücklichen Hinweises bei der Annahme oder Bestätigung verbindlich.
04. Eventuelle Reklamationen oder Beanstandungen geben dem Kunden nicht das Recht die Zahlung der Lieferungen zu unterlassen oder zu verzögern. Damit die Reklamationen gültig sind, müssen sie 8 Tage nach Erhalt der Ware bei uns eingehen.
05. Der Kunde kann ohne unsere ausdrückliche schriftliche Zustimmung auf keinen Fall Material zurückgeben. Im Falle von höherer Gewalt behalten wir uns das Recht vor, Lieferungen einzustellen sowie ordnungsgemäß angenommene Aufträge zu stornieren, ohne, dass dies dem Kunden das Recht gibt Entschädigungen oder Schadensersatz zu fordern.
06. Eventuelle Verspätungen der Lieferungen geben dem Kunden nicht das Recht, Entschädigungen und/oder Schadensersatz zu fordern. Die Lieferungen, auch nur Teillieferungen, können vom Kunden nicht verweigert werden und geben kein Recht zur Stornierung des Auftrages.
07. Die Übergabe des Materials ist immer frei ab Werk. Unsere Verantwortung endet mit der Auslieferung an den Kunden oder an das Transportunternehmen, somit gehen Risiko und Gefahr auf den Kunden über. Im Falle, dass aufgrund besonderer Einigungen mit dem Kunden, das Material frei Bestimmungsort als verkauft gilt, werden in keinem Fall Beanstandungen wegen eventuellen Diebstahls, Bruchschäden oder Beschädigungen akzeptiert. Eventuelle Absprachen mit Speditionsunternehmen, darin inbegriffen der Betrag und die Zahlung der Transportkosten, gelten immer als abgeschlossen im Namen und für den Kunden, der unsere Handlungen akzeptiert und bestätigt.

# Condizioni generali di vendita / General sales conditions

## Allgemeine Verkaufsbedingungen / Conditions generales de vente

### Condiciones generales de venta

**08.** Alle unsere Produkte werden im Werk sorgfältig geprüft. Deshalb werden sie gegen Fabrikationsfehler für einen Zeitraum von zwei Jahren ab dem Ausstellungsdatum der Rechnung oder des Steuerbeleges von dem Händler mit einer Garantie gedeckt.

**09.** Der Hersteller verpflichtet sich, die Teile zu reparieren oder zu ersetzen, die innerhalb der Garantiezeit Fabrikationsfehler zeigen. Defekte, die nicht deutlich den Material- oder Verarbeitungsfehlern zugeschrieben werden können, werden bei unserem Kundendienst geprüft und nach dem Ergebnis der Überprüfung berechnet. Von der Garantie sind auch zufällige Schäden ausgeschlossen, die dem Transport, Nachlässigkeit, falscher und nicht entsprechender Installation oder der nicht richtiger Nutzung zugeschrieben werden können. Die Garantie erlischt, falls unerlaubte Dritte das Gerät geöffnet oder repariert haben. In diesem Fall werden das Ersetzen des Gerätes und die Verlängerung der Garantiezeit ausgeschlossen, wenn eventuelle Schäden dazwischen kommen. Reparaturen werden bei unserem autorisierten Kundendienst durchgeführt. Das Gerät, das repariert oder ersetzt werden soll, soll bei unserem Kundendienst frei ankommen, das heißt, auf Kosten des Kunden.

**10.** Wir weisen jegliche Verantwortung für Schäden an Personen, Tieren und Sachen zurück, die aus dem Gebrauch der Geräte hervorgehen, ohne dass die Sicherheitsbestimmungen beachtet wurden bzw. die Geräte nicht ordnungsgemäß installiert wurden und/oder installiert wurden, ohne dass Kontrollen erfolgten.

**11.** Die auf der Preisliste aufgeführten Preise sind nach Abzug der Mehrwertsteuer zu verstehen.

**12.** Für jede Streitigkeit durch unseren Verkauf wird der Vertrag von dem italienischen Gesetz geregelt und der Gerichtsstand ist ausschließlich Brescia.

#### CONDITIONS GENERALES DE VENTE



**01.** Les conditions générales de vente présentes impliquent que le client accepte intégralement ces conditions au moment de l'attribution de la commande.

**02.** Les commandes ou les engagements pris par nos agents ne sont valables qu'après notre acceptation ou confirmation écrites.

**03.** Les données, les mesures, les articles, les prix, les caractéristiques, les prestations et toutes les autres données indiquées sur nos catalogues, listes des prix, publicités, circulaires etc. sont à titre indicatif, sujets à des variations sans aucun préavis et ils prennent effet uniquement en cas d'acceptation ou de commande.

**04.** Réclamations ou contestations éventuelles n'autorisent en aucun cas le client à renoncer ou à retarder les paiements de la fourniture. Pour que les réclamations soient valables, elles doivent nous parvenir sous 8 jours à partir de la date de réception de la marchandise.

**05.** Le client ne pourra nous restituer pour aucune raison le matériel sans notre autorisation expresse écrite. En cas de force majeure, nous nous réservons le droit de suspendre les livraisons ou même d'annuler les commandes dûment acceptées sans que cela puisse donner droit au client de demander une quelconque indemnisation ou un quelconque remboursement des dégâts.

**06.** Retards éventuels de livraison ne donnent pas droit au client à des indemnités et/ou des remboursements pour dommages et intérêts. Les livraisons, même partielles de marchandise ne peuvent pas être refusées par le client et ne donnent pas droit à l'annulation de la commande.

**07.** La livraison du matériel est effectuée franco notre usine. Notre responsabilité cesse lors de la livraison au client ou au transporteur et par conséquent la marchandise voyage aux risques du client. Dans les cas où, suite à des accords spécifiques avec le client, le matériel serait vendu "franco d'arrivée", des contestations pour d'éventuels vols, dégâts ou manipulations ne seront pas acceptées. D'éventuels accords pris avec les transporteurs, concernant le montant et le paiement du prix du transport, seront toujours conclus par le client qui accepte et ratifie notre démarche comme ferme et définitive.

**08.** Tous nos produits sont soigneusement testés à l'usine, et ils sont donc garantis contre les défauts de fabrication pour une période de deux ans à compter de la date d'émission de la facture ou du reçu du revendeur.

**09.** Le fabricant s'engage à réparer ou à remplacer gratuitement dans la période de garantie, les parties qui montrassent des défauts de fabrication. Défauts pas clairement attribuables au matériel ou au processus de fabrication seront examinés par notre centre de service et facturé en fonction des résultats de la vérification. Sont exclus de la garantie: les dommages accidentels dus au transport, à la négligence, à l'utilisation et d'installation incorrecte ou non conforme aux instructions de la notice d'entretien. La garantie est nulle si l'appareil a été altéré ou réparé par un tiers non autorisé. Dans ces cas, est exclus le remplacement de l'appareil ou la prolongation de la garantie, si des dommages se vérifient. Les réparations sont effectuées

chez notre centre d'assistance technique autorisé: les appareils à réparer ou à remplacer sous garantie doivent être reçus en port franc, c'est à dire à la charge du client.

**10.** Nous déclinons toute responsabilité pour des dommages causés à des personnes, animaux ou biens dus à l'utilisation d'appareils sans l'observation des consignes de sécurité ou non installés correctement et/ou sans effectuer les contrôles d'usage.

**11.** Les prix reportés sur la liste n'incluent pas la TVA.

**12.** Toute controverse dérivant de notre vente, le contrat sera réglementé par la Loi Italienne, et le tribunal compétent sera uniquement le Tribunal de Brescia.

#### CONDICIONES GENERALES DE VENTA



**01.** Estas condiciones generales de venta se considera totalmente aceptadas por el cliente en la confirmación del pedido.

**02.** Las órdenes o compromisos hechos por nuestros representantes sólo serán válidas después de nuestra aceptación o confirmación por escrito.

**03.** Los datos, medidas, artículos, precios, características, prestaciones y demás datos reproducidos en nuestros catálogos, listas de precios, folletos, circulares, etc. son indicativos, están sujetos a cambios sin previo aviso y son vinculantes para nosotros sólo en el caso de cualquier indicación de aceptación o confirmación.

**04.** Cualquier reclamación o disputa no dará de ninguna manera derecho al cliente a omitir o demorar el pago de la prestación. Para ser válidas, las reclamaciones deben recibirse dentro de los 8 días siguientes a la recepción de la mercancía.

**05.** El cliente no puede devolver el material sin nuestro permiso expreso por escrito. En el caso de disputa, nos reservamos el derecho de suspender las entregas y también de cancelar los pedidos debidamente aceptados sin que el cliente tenga derecho a pedir ninguna compensación o indemnización.

**06.** Cualquier retraso en la entrega no dará derecho al cliente a ningún tipo de compensación o indemnización. Incluso en las entregas parciales de la mercancía no pueden ser rechazadas por el cliente y no tienen derecho a cancelar el pedido.

**07.** El envío de los materiales siempre se realiza "franco fábrica". Nuestra responsabilidad termina al entregar el material al cliente o a la compañía de transporte, a partir de entonces el material corre por cuenta, cargo y riesgo del cliente. En los casos en que, por acuerdos específicos con el cliente, el material se venda "a portes pagados", en ningún caso, se aceptará ninguna objeción por robo, rotura o deterioro. Los convenios celebrados con transportistas, incluyendo la cantidad y el pago del precio del transporte, se entenderán que van siempre en nombre y a cargo del cliente a partir de que acepta y ratifica nuestra confirmación de pedido.

**08.** Todos nuestros productos son cuidadosamente probados en fábrica, y por lo tanto son garantizados contra defectos de fabricación por un período de dos años a partir de la fecha de emisión de la factura o el recibo expedido por el distribuidor.

**09.** El fabricante se compromete a reparar o sustituir gratuitamente las piezas dentro del período de garantía, cuando se considere defecto de fabricación. Los defectos no claramente atribuibles a fabricación de los materiales o mano de obra, serán examinados en nuestro centro de asistencia técnica y en función del resultado se procederá al informe de responsabilidades. Quedan excluidos de la garantía: daños accidentales sufridos por el transporte, negligencia, instalación o utilización incorrecta y el no cumplimiento de las advertencias e indicaciones que aparecen en el folleto de instrucciones. La garantía se anula si la unidad ha sido manipulada o reparada por terceros no autorizados. En estos casos, la sustitución del aparato y la extensión de las garantías quedan intervenidos por las anteriores indicaciones. Las reparaciones se llevan a cabo en nuestro centro de asistencia técnica autorizado, las mercancías que deban ser reparadas o reemplazadas bajo garantía deben ser recibidas en el centro de asistencia técnica debidamente empaquetados, con los gastos de transporte a cargo del cliente.

**10.** Fábrica desestima toda responsabilidad de cualquier daño producido a personas, animales o bienes derivados de la utilización de los equipos que no hayan cumplido con los requisitos de seguridad e instalación correcta, e instalados sin pasar controles de uso.

**11.** Los precios de la tarifa son sin IVA.

**12.** Para cualquier controversia que surja de nuestra venta, el contrato se regirá por la ley italiana y la competencia será únicamente del Tribunal de Brescia.

# PHormalab

is a brand of Urbani S.r.l

Via G. Garibaldi 67/C  
Lumezzane  
25065 - Brescia

Tel: +39.030.871513

Web-site: [www.phormalab.it](http://www.phormalab.it)  
E-mail: [info@phormalab.it](mailto:info@phormalab.it)

MADE IN ITALY

Patented

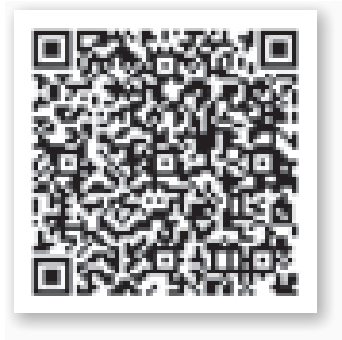

design by



[www.antoniodichiano.com](http://www.antoniodichiano.com)