

VORO MOTORS

RS MIDNIGHT
Electric Scooter User Manual



Before using your scooter, please read the instructions, and keep this manual for ready reference.
Original instructions

VORO MOTORS

GETTING STARTED

Thank you for choosing the INMOTION electric scooter(hereinafter referred to as the scooter)! This scooter is an intelligent high-tech entertainment product. When you use the scooter, there may be situations such as falling or collision that can cause injury and other risks. To reduce possible risks and ensure the personal and property safety of yourself and others, you have the responsibility and obligation to carefully read the user manual, fully understand all the warnings and precautions listed in this manual, and ensure that you can use it correctly. To obtain the latest feature/function information and safety guidance, please download the electronic version from the official website. Important! Read carefully and keep for future reference.

Serial number (referred to as SN below) is a unique identifier for each product, which can be used for product warranty, maintenance, insurance claims, loss confirmation, and so on. The SN is a 16-character numeric code that can be found on the packaging box label, the body of the product, or in the device information section of the associated App.

Get closer to your seller so he can refer you to an Appropriate training organization.

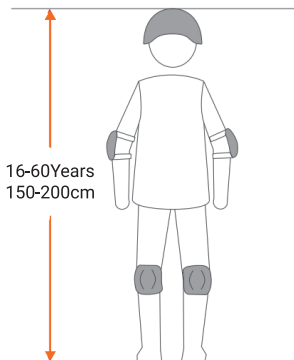

When riding an electric scooter, please wear a helmet, knee pads, elbow pads, wrist guards and other protective gear throughout the journey to reduce the risk of injury.

All pictures in this manual are for reference only. Please refer to the actual product for accuracy.

PRODUCT LIST

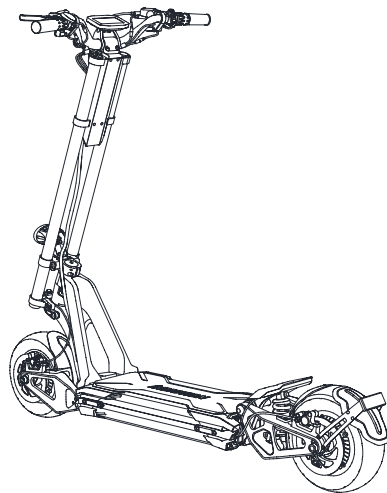

User Manual



Quick Start Guide

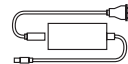

Power Cord/Adapter



Headlights



Mudguard Components



Reflectors * 2



Reflector Stickers * 10



Combination Wrench



T-shaped Wrench M5 * 2



M5x30 Hexagonal
Cylindrical Head
Screws * 4



M4x8 round head
hexagon socket
screw * 1



M4x10 Hexagonal
Cylindrical Head
Screws * 4



M8x16 Hexagon
Socket Head
Cap Screw * 1

Notice:

- Please carefully check whether the items in the packaging box are complete and intact. If any parts are missing or damaged, please contact your purchase point or send an email to the manufacturer.
- Please keep the box and packaging materials for at least 30 days in case you need to ship the scooter in the future.

PRODUCT FUNCTION INTRODUCTION

Product Diagram

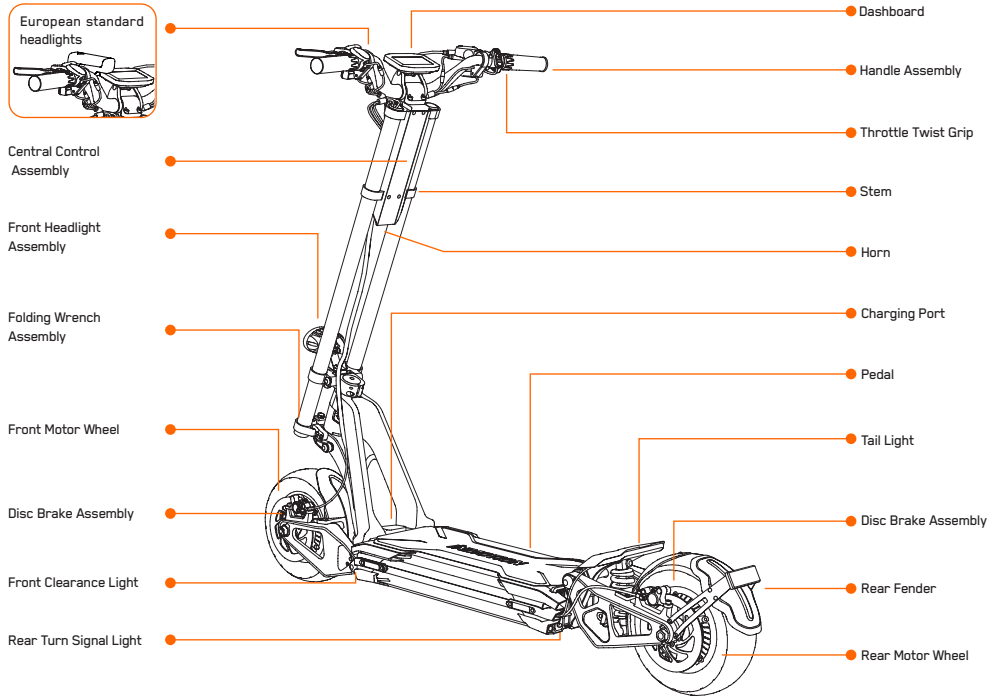



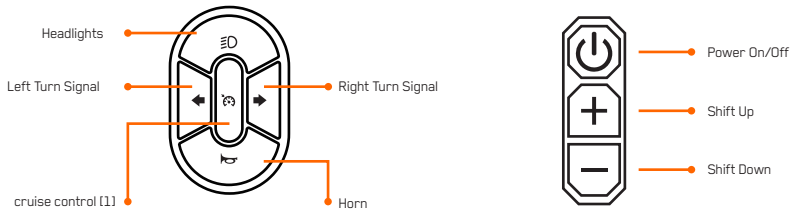
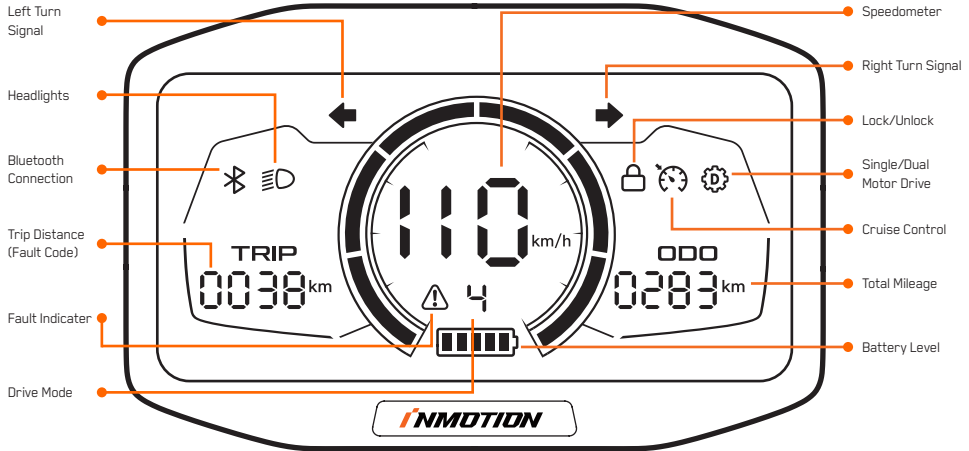











Dashboard and Buttons



[1]: Short Press: cruise control, long press: single/dual drive switching.

Product Function Introduction

Icon	Icon Name	Icon Description
	Power On/Off	Press and hold the power button to turn on/off the scooter. It will also automatically power off if there is no activity for 10 minutes, which can be adjusted through the App.
	Parking mode	0 represents the Parking mode. The scooter defaults to the Parking mode when it turns on. Press the + or - buttons to switch to the driving mode. You can also switch and adjust relevant parameters via the app.
	Drive mode	1-4 represents drive mode include four modes. 1 represents Eco mode with a speed limit of 32km/h. 2 represents Normal mode with a speed limit of 64km/h. 3 represents Sport mode with a speed limit of 100km/h. 4 represents Extreme mode, with no speed limit. The modes can be switched in order by pressing the + or - buttons. Note: The mode cannot be switched when pressing the throttle.
	Speedometer	Shows the speed of the scooter in real time.
	Speed unit	The Imperial System and the metric one, you can change the unit via the App.
	Light icon	Press the headlight button to toggle the headlights on or off.
	Bluetooth icon	The icon lights up after the bluetooth connection is successful.
	Cruise Control	While riding at a constant speed, press the button to activate or deactivate cruise control. Long press to switch single/dual drive mode.
	Locking	To use the locking feature, the owner of the scooter must first authenticate themselves through the App. Once connected, a lock icon will appear on the home screen. Click on the icon to lock or unlock the scooter. If the scooter is moved while locked, the lights and horn will cycle and then sound a single alarm after 3 seconds.
	Fault indicator	The icon indicates that the scooter has detected an error. Refer to the error code table to find solutions.
	Turn signal	Press the turn signal button, the turn signal on the corresponding side will flash for 5s.
	Battery level	The battery level is indicated by 5 bars, the last bar flashing indicates a low-battery level.
	Horn	Press the button while the scooter is powered on to honk the horn.
	Single/Double Drive Switching	Press and hold the cruise control button while the scooter is stationary to switch between single and double drive modes. The sequence of switching is Dual Drive -> Rear Drive -> Front Drive, and the driving mode icon will change accordingly.

ERROR CODE

Front/Rear Drive Controller Malfunction

Code	meaning	Explanation
101/201	Current sampling failure of drive controller	Controller malfunction, please reboot or contact after-sales service for replacement.
102/202	Hall fault of drive motor	Motor malfunction, please contact after-sales service for replacement.
109/209	Instrument did not receive data from the drive controller	Communication failure, the instrument did not receive the controller data.
110/210	Drive controller did not receive data from the instrument	Communication failure, the controller did not receive data from the instrument.
111/211	MOS over-temperature of drive controller	The temperature of the controller board is too high, please stop riding and wait for to cool down.
112/212	Overheating of drive motor	The motor temperature is too high, please stop riding and wait for the temperature to decrease.
114/214	Overheating of drive MCU	The MCU temperature is too high, please stop riding and wait for the temperature to decrease.
117/217	Overcurrent fault of drive controller	Controller malfunction, please reboot or contact after-sales service for replacement.
118/218	Stuck fault of drive controller	Motor stuck, please remove obstacles or contact after-sales service for replacement.

Notice:

- The first digit of a three-digit error code represents the faulty part, with 1 representing the front wheel and 2 representing the rear wheel

Other Faults

Code	meaning	Explanation
003	Battery communication failure	Battery malfunction, please contact after-sales service for replacement.
004	Undervoltage fault of the controller	The battery voltage is too low, please charge it in time.
005	Overvoltage fault of the controller	The battery voltage is too high, please stop using it and contact after-sales service.
006	Brake handle failure	When starting up, the brake handle is not released, please release the brake handle or check the brake handle.
007	Throttle handle failure	The throttle is detached or the throttle is not released when starting up, please release the throttle or check the throttle.
008	Battery error (undefined alarms, protections, and faults)	Battery malfunction, please contact after-sales service for replacement.
013	Battery over-temperature	The battery temperature is too high, please stop riding and wait for the temperature to decrease.
015	Attitude sensor initialization failure	Gyroscope initialization failure, please contact after-sales service.
016	Scooter fall warning	This error will be reported when the vehicle tilts over 45 degrees.

PRODUCT SPECIFICATIONS

Specifications	Item	Parameters
Basic Specifications	Model	RS
	Overall size of the Scooter	1453 * 716 * 1320mm (default)
	Net Weight	Approximately 58kg
Riding Requirements	Maximum Load Capacity	150kg
	Suitable Height	150-200cm
	Applicable Age	Ages 16-60
Main Scooter Parameters	Normal Riding Distance ^[1]	Approximately 120-160km
	Max. Climbing Angle ^[2]	26°
	Max. Speed ^[3]	25km/h
	Waterproof Rating	IP56
	Charging Time	8.5 hours
	Temperature	-10° C - 40° C
Battery Pack Parameters	Storage Temperature	-10° C - 40° C
	Intelligent BMS	Overcharge, overheat, over-discharge, over-current, short circuit, overvoltage
	Rated Voltage	84V
Charger	Rated Capacity	2880Wh
	Rated Input Voltage	AC100-240V 50/60HZ
	Rated Output Voltage (DC)	84V 5A
Others	Display	4.3-inch LCD screen
	Output Port	USB type-C
	Tire Size	11-inch vacuum tire (standard pressure: 40Psi or 2.8Bar)

[1]: Measured under the condition of full charge, 75kg load, ambient temperature of 25°C, and riding on flat, hardened road surface at a speed of 20-40km/h. The range is related to temperature, tire pressure, road conditions, riding habits (such as sudden acceleration, suspension), etc.

[2]: Measured with a load of 75kg and full battery.

[3]: Tested on a flat, hard surface with no wind and an ambient temperature of 25°C at full battery and carrying a load of 75kg.

Product Description

RS is a high-tech entertainment product. Riding it without understanding the operating procedures may cause unpredictable injuries and property damage. The following text will provide users with detailed instructions on how to properly use RS and precautions during use. Please read carefully and use RS as required. Before using RS, make sure that all parts are intact and installed correctly.



Warning:

- Before using the RS, please make sure that the battery is fully charged, preferably to 80% or more.
- You need to find a relatively open and flat outdoor area for driving practice. You need to have a good understanding of the driving environment around you to ensure that you will not be disturbed by obstacles such as cars, pedestrians, pets, bicycles, etc.
- Take the time to learn the basics of the practice to avoid any serious accident that can take place in the first months.
- You need a skilled assistant to guide you and be familiar with all the precautions and usage methods in this manual.
- Please do not test the scooter on wet or slippery ground.
- It is recommended that users wear comfortable casual or sports clothing, flat shoes, and warm up exercises to maintain flexibility.
- Please make sure to wear a helmet and riding protective gear to avoid injury.

ASSEMBLY

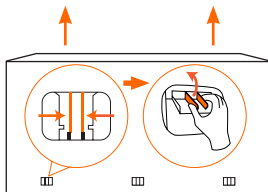

Open the package:

Take out the 6 connecting buckles and lift the outer box upwards, revealing the inner packaging and scooter, and take out the accessory box.

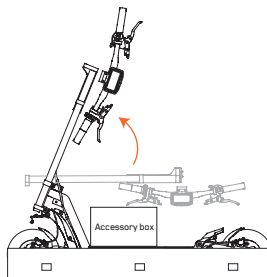

Hold the handlebars and unfold the folding stem:

Adjust the height of the stem according to the scale and lock the stem clamp.

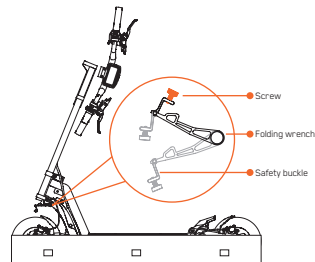

Fasten the folding wrench:

Fasten the folding wrench according to the diagram, turn the screw by hand to fix the safety buckle.

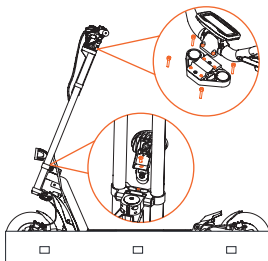

Install the handlebar and front headlight assembly:

Take out four M6*30 cylindrical head screws and one M8*16 hexagonal socket screw, tighten them in the corresponding positions according to the diagram.

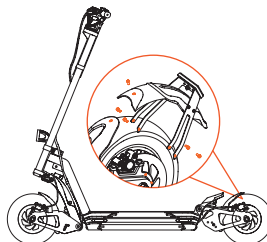

Install the rear mudguard:

Take out four M4*10 cylindrical head screws and one M4*8 round head hexagonal screw, tighten them in the corresponding positions according to the diagram.

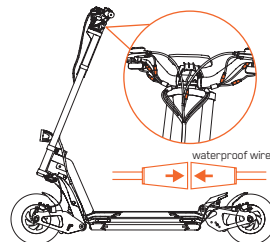

Connect the waterproof wire:

Connect the corresponding lines according to the color and follow the directional arrows. (Power switch key, dashboard, throttle, brake, turn signal, headlight waterproof wire)

ACTIVATE THE VEHICLE



Download the App via methods below

1. Scan the QR Code on the left.
2. Search "INMOTION" on  or .
3. Directly visit: www.inmotionworld.com/support/app

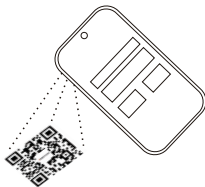

1. Download and install the App, register/login your account.

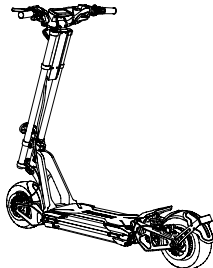

2. Power on the scooter, pair your scooter with the INMOTION App. The scooter will beep when the connection is successful.

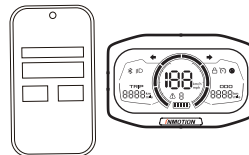

3. Follow the App instructions to activate the scooter and learn how to ride safely. You can now start to use your scooter.

Warning:

- There are safety risks when using a scooter. To ensure your riding safety, each scooter is shipped in an unactivated state, limited to ECO mode. You can activate your scooter by downloading the App to unlock full functionality.

ADJUST THE GEARS

For a better riding experience, there are four adjustable gears on the scooter, and the chassis height can be adjusted according to road conditions or personal habits. Instructions: Use two T-shaped hex wrenches to fix the screws at both ends of the connecting shaft. Rotate one screw counterclockwise to loosen it, remove the other screw from the connecting shaft, install the connecting shaft into the hole corresponding to the target gear according to your needs, and then tighten the previously loosened screw with the wrench.

Clockwise rotation of the screw increases the damping; Counterclockwise rotation reduces the damping.

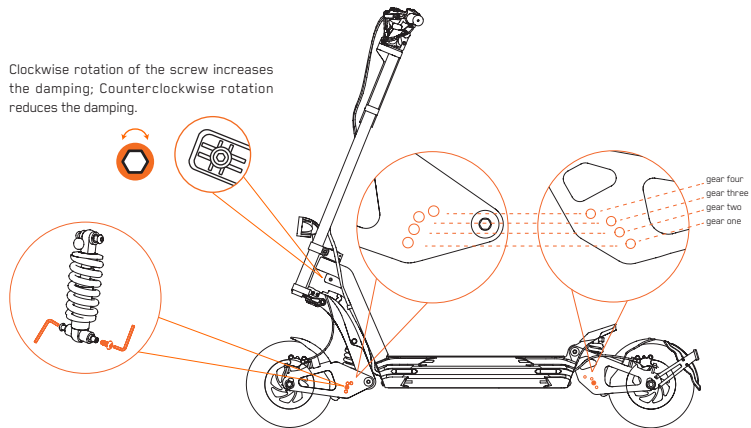

Scan the QR code
to watch the video

Dimensions in folded/unfolded state

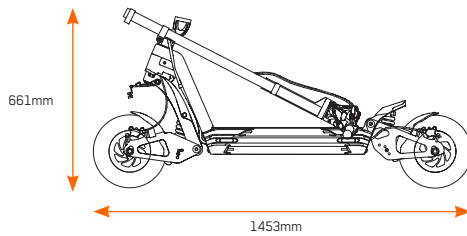
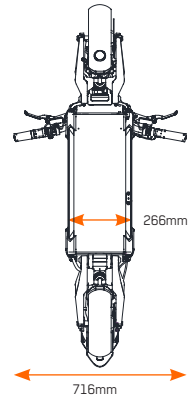
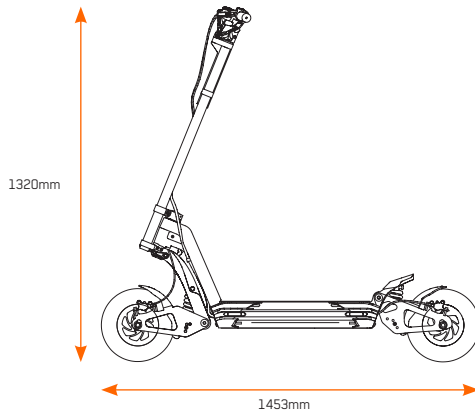

CHARGING

- The original charger is 84V 5A. The blue LED indicates power, the green LED indicates a full charge, and the red LED indicates that the scooter is currently charging. When two chargers are used simultaneously, the charging time will be reduced by 50%.

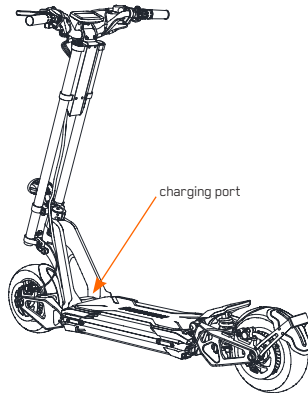

Warning:

- Do not charge if there is water at the charging port or power cord.
- Please use the original adapter for charging.
- Do not charge indoors.
- Cover the lid tightly after charging.
- Do not charge if the battery is damaged or has been exposed to water.
- If not in use for a long time, it is recommended to charge once every three months.

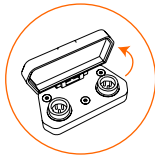

1. Open the charging port.



2. Insert the charger plug.

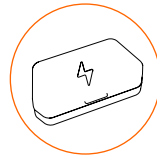

3. After charging is complete, unplug the charger plug and cover the charging port tightly.

INFLATING

For a better cycling experience, please be sure to check the tire pressure before each ride. If the tire pressure is low, please pump it up in a timely manner. The ideal tire pressure range is between 2.5 to 3.5 bar.

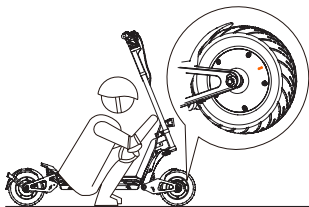

1. Unscrew the valve cap of the tire.

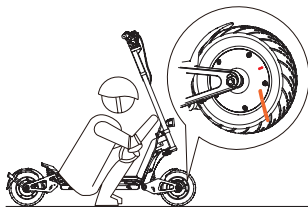

2. Screw the extension nozzle onto the valve and tighten it.

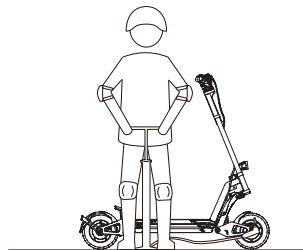

3. Connect the pump and inflate the tire to the recommended pressure.

Warning:

- The range and riding experience of the electric scooter are related to tire pressure. When the tire pressure is within the normal range, higher tire pressure will result in longer range; lower tire pressure will provide better shock absorption experience, especially on rough roads. Please choose the appropriate tire pressure according to specific usage scenarios.

LEARNING TO RIDE

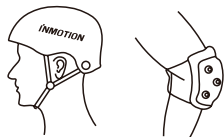

1. Wear Approved helmets, elbow pads, knee pads, and other protective gear to minimize any possible injuries.



2. Check the battery indicator light after turning on the power. If the battery level is low, please charge the electric scooter.



3. Stand with one foot on the pedal and push off with the other foot to start gliding.

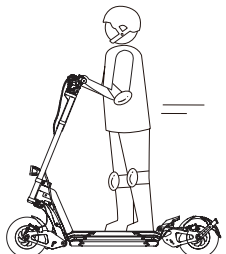

4. Stand with both feet on the pedals, twist the throttle handle to start riding.

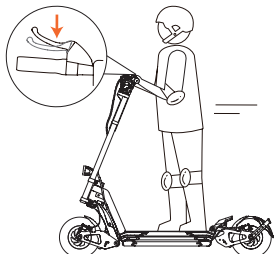

5. Release the throttle and gently grip the brake lever to brake.

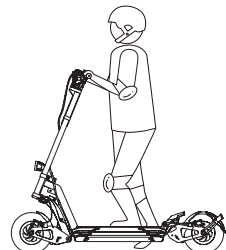



6. When the electric scooter stops or slows down, put one foot down to dismount.

SAFE DRIVING GUIDE

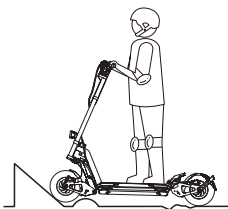

 Do not ride the scooter in the rain.



 Do not ride at high speed when you get over speedbumps, thresholds etc., please ride at low speed on rough roads.

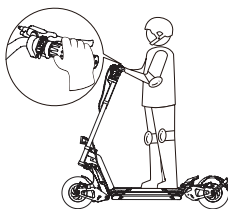

 Do not press the throttle when walking with the scooter.

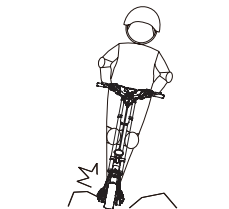

 Avoid contacting obstacles and watch out for the road conditions.

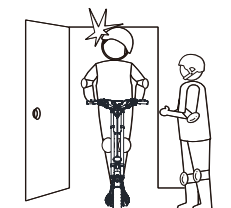

 Watch your head when passing through doorways.

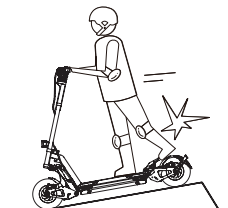

 Do not step on the rear fender.

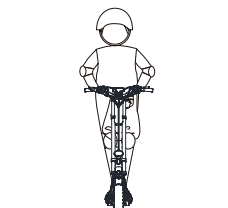

 Do not carry heavy objects on the handlebar.



 Do not ride the scooter with only one foot or one hand.

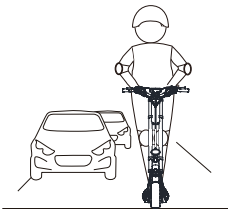

 Do not ride on motorways, public roads, or highways.

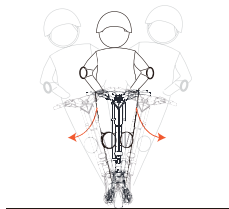

 Do not rotate the handle violently while driving at high speed.

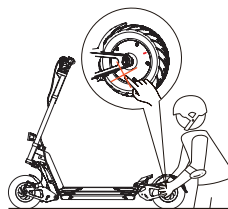

 Do not touch the motor, it may overheat after running.

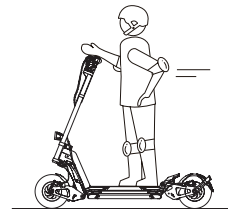

 Do not take your hands off the handlebar while riding.

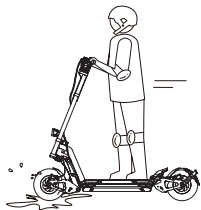

 Do not ride through puddles, please go around at low speed.

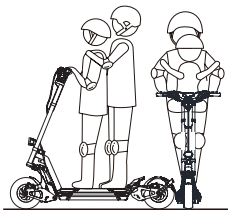

 Do not carry any passengers especially a child. Do not ride when pregnant.

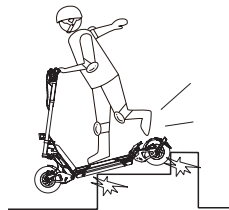

 Do not ride up and down stairs or jump over obstacles.



 Do not use mobile phone or wear earphones when riding the scooter.



Talk to someone 24/7



Refer someone to earn \$200
and give up to \$100 discount



INMOTION App



Facebook group



Website