



NEC

NDA-31587
ISSUE 1.0

UNIVERGE[®] SV9100
DT730G (ITL-12CG/DG)

USER GUIDE

NEC Corporation of America
September, 2014

NEC Corporation of America reserves the right to change the specifications, functions, or features at any time without notice.

NEC Corporation of America has prepared this document for use by its employees and customers. The information contained herein is the property of NEC Corporation of America and shall not be reproduced without prior written approval of NEC Corporation of America.

D^{term}, NEAX and UNIVERGE are registered trademarks of NEC Corporation. Windows is a registered trademark of Microsoft Corporation.

Copyright 2014

**NEC Corporation of America
6535 N. State Highway 161
Irving, TX 75039-2402**

Communications Technology Group

TABLE OF CONTENTS

1. INTRODUCTION

General	1
Face Layout	2
Technical Specifications	3
Keys And Parts	5
Installation Procedure	7
Wall Mounting	12
Phone Start Up and Menu Screen	15
Shortcut Menu	20
Soft Keys	22
Multi-Window	24
Pop-up Windows	30

2. TERMINAL SETUP

Setup With Up/Down Key	33
Setup With Feature Key	33
Setup with Menu Key	34

3. BASIC OPERATION

To Login	89
To Logout	89
To Make an External Call	90
To Make an Internal Call	90
To Answer an External Call	91
To Answer an Internal Call	91
To Hold a Call	91
To Transfer a Call	92
One-Touch Speed Calling Keys	92

TABLE OF CONTENTS

Speed Dialing – Station/Group	93
Last Number Redial	93
Redial.....	94
Voice Call.....	95
Three-Party Conference	95
Voice Mail System	95
Do Not Disturb	96
How to Input Characters	97
Security Mode.....	110
Phonebook.....	113

4.DIRECTORY OPERATION

To Add New Data	115
To Find Registered Data.....	116
To Make a Call from Directory	117
To Add Prefix Number	117
To Delete All Data.....	119
To Delete Specific Directory Data.....	119

5.CALL HISTORY OPERATION

To View Call History	121
To Make a Call from Call History	121
Store Call History data to Speed Dial	122
To Delete Call History Data	122

APPENDIX: PHOTO FRAME APPLICATION

To Launch Photo Frame Application	123
Display Sample and Key Operations	123

TABLE OF CONTENTS

How to Use the Photo Frame Application Using USB Memory	124
---	-----

MENU LIST

Menu List: DT730G (ITL-12CG-3)	131
Menu List: DT730G (ITL-12DG-3)	136

WEB PROGRAMMING

To Login	141
To Logout	143
How to Operate	144

TABLE OF CONTENTS

THIS PAGE INTENTIONALLY LEFT BLANK

1. INTRODUCTION

General

This guide explains how to operate DT 730G Series under the following headings.

CHAPTER 1 INTRODUCTION

Explains the configuration of this guide and contains the following information.

- Face layout of DT Series
- Keys and Parts of DT Series
- Icon Display
- Menu List

CHAPTER 2 TERMINAL SETUP

Explains the operating procedures for terminal settings of the DT Series.

CHAPTER 3 BASIC OPERATION

Explains the basic operation of DT Series.

CHAPTER 4 DIRECTORY OPERATION

Explains operating procedures for Directory function.

CHAPTER 5 CALL HISTORY OPERATION

Explains operating procedures for Call History.

Face Layout

**DT730G (CG): ITL-12CG-3
(For North America)**

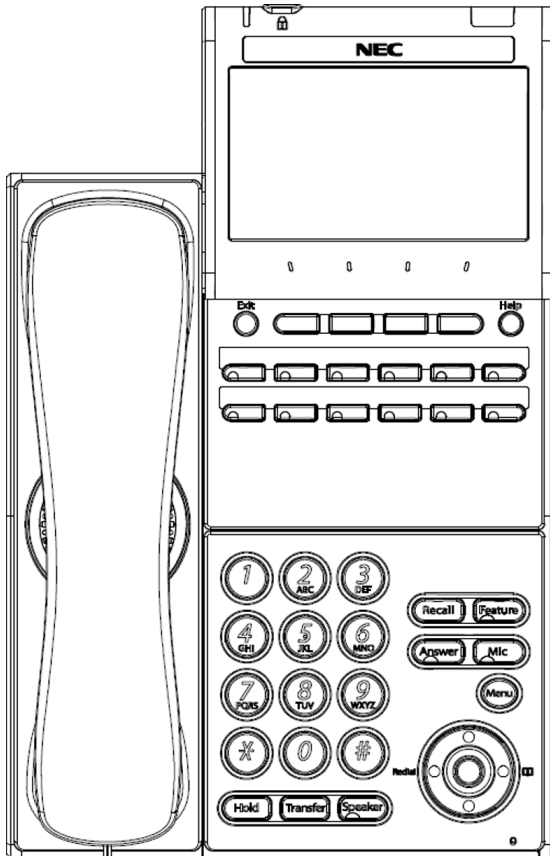

**DT730G (DG): ITL-12DG-3
(For North America)**



Technical Specifications

Item	ITL-12CG-3
Display LCD	4.3 inch Color (16777216 colors) TFT, with Backlight
Programmable Key	12 Keys
Fixed Feature Key	10 keys (including Menu button and Cursor key)
Backlight	Display and Digit Key (lit for 10 seconds when operating)
Soft Key	4 Keys
Directory	500 Records
Call History	Outgoing Call: 50 records, Incoming Call: 50 records
XML Browser	Available
Hands-free	Standard equipment (Full-duplex)), Wide-band
Headset	Available (HW251N-A10-NE: optional)
USB Interface	USB Host 1-port (Supporting USB 2.0, Power Supply = 5V/500mA) Overcurrent Level = approximately 500mA
LAN Interface	2-port, 10BASE-T/100BASE-TX/1000BASE-T, Full-duplex/Half-duplex, Auto Negotiation/Fixed (Except 1000BASE-T)
Voice CODEC	G.711(μ -law, A-law), G.729a, G.722
IP Address Setting	Sets via DHCP server/Sets Statically
QoS	ToS (IP Precedence, Diffserv)
VLAN	Tag VLAN (IEEE802.1Q/p)
Security	IEEE802.1x authentication (EAP-MD5, EAPOL Forwarding), SIP&RTP Encryption
Power Supply	Central Power Supply = IEEE802.3at Type 1 (Compatible with IEEE802.3af), Local Power Supply = AC adapter (AC-L UNIT/AC-2R UNIT: optional)
Power Consumption	Approximately 4.9 W (without optional connection)
Download	Program/Configuration data/Ringing Tone/ Music on Hold/Directory data/Wallpaper
Adapter (Optional)	Recording Unit/Analog PSTN Adapter (PSA) Unit/60 Button DSS Console (DCL-60-1)/8 Button Unit (8LK-L)
Terminal Color	Black
Dimension (WxDxH)	179(W) \times 278(D) \times 112(H) [mm]
Weight	1.2 kg
Environmental	Operational Temperature range = 0 to 40 $^{\circ}$ C (Storage temperature range = -20 to 60 $^{\circ}$ C) Humidity = 10 to 90% RH (not condensing)

Item	ITL-12DG-3
Display LCD	3.8 inch Gray Scale FSTN, with Backlight
LCD Color	Gray Scale (8 scales)
Programmable Key	12 Keys
Fixed Feature Key	9 keys (including Menu button and Cursor key)
Backlight	LCD and Digit Key (lit for 10 seconds when operating)
Soft Key	4 Keys
Directory	20,000 records per system
Call History	Outgoing Call: 10 records (Fixed) per terminal Incoming Call: Maximum 50 records (Initial value 10 records) per terminal
XML Browser	Available
Hands-free	Available (Full-duplex), Wide-band
Headset	Available
USEB Interface	USB Host 1-port (USB 2.0, Power Supply = 5V/500mA) Overcurrent Level = approximately 500mA or more
LAN Interface	2-port, 10BASE-T/100BASE-TX/1000BASE-T, Full-duplex/Half-duplex, Auto Negotiation/Fixed (Except 1000BASE-T)
Voice CODEC	G.711(μ -law, A-law), G.729a, G.722
IP Address Setting	Sets via DHCP server/Sets Statically
QoS	ToS (IP Precedence, Diffserv)
VLAN	Tag VLAN (IEEE802.1Q/p)
Security	IEEE802.1x authentication (EAP-MD5, EAPOL Forwarding), SIP&RTP Encryption
Power Supply	Central Power Supply = IEEE802.3at Type 1 (Compatible with IEEE802.3af compatible), Local Power Supply = AC adapter (AC-LE UNIT: optional)
Power Consumption	Approximately 4.9 W (without USB and optional connection)
Download	Ringing Tone/ Music on Hold/
Adapter (Optional)	Ancillary Device Adapter (ADA-L) / Power Save Adapter (PSA-L) / 60 Button DSS Console (DCL-60-1)/8 Button Line Key Unit (8LK-L) / 16-button Line Key Unit (16LK-L)
Dimension (WxDxH)	179(W) × 258(D) × 112(H) [mm]
Weight	1.15 kg
Environmental	Operational Temperature range = 0 to 40 °C (Ambient temperature range = -20 to 60 °C) Humidity = 10 to 90% RH (not condensing)

Keys And Parts

DT730G



(1) Security Button

To activate security features for preventing unauthorized access or data leakage.

(2) Handset

Used for sending/receiving voice.

(3) Exit Button

To exit the **Menu** or **Help** mode and go back to the time display.

(4) Speaker

Used when originating a handsfree call.

(5) Dial Keypad

Dial the called party number or feature access code.

(6) Hold Key

To place an internal or external call on hold.

(7) Transfer Key

Allows the station user to transfer established calls to another station, without attendant assistance.

(8) Speaker Key

To control the built-in speaker which can be used for:

Hands-Free dialing/monitoring.

LED on key lights when the key is active.

* All standard IP versions include support for full duplex hands-free mode. All TDM and IP enabled versions are half duplex hands-free mode.

(9) Cursor Key

By using this key, you can access various features with simple operation.

Details on Cursor Key

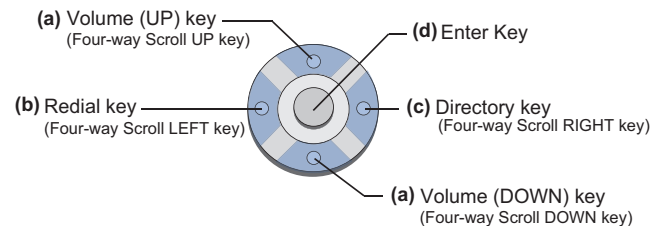

(a) Up/Down

(∨ DOWN ∧ UP)

Used to adjust speaker/receiver volume, and ringer volume.

- Speaker/Receiver Volume:
Press (∨) or (∧) key during conversation.
- Ringer Volume:
Press (∨) or (∧) key during ringing.

(b) Redial

(Last Number Call, Speed Calling-Station/Group) Press this key to activate redial feature. Press **Redial** and scroll back through numbers that have been dialed. When the desired number is displayed, press * or # to activate dialing.





Note: *A-law Countries [Europe, Australia, Russia, Latin America, Middle near East, other Asian nations]: #*
*μ-law Countries [North America]: **

(c) Directory

Pressing this key opens Directory menu. For details on Directory service, see [4.DIRECTORY OPERATION](#).

(d) Enter

DT730G has shortcut menu for frequently-used features. Use this key to display the shortcut menu (see [Multi-Window](#)) and determine the selected item in the menu. Also, this key is used as cursor-movement key on the local menu of the telephone.

	Up	Move the highlighted area one line up the screen.
	Down	Move the highlighted area one line down the screen.
	Left	Go back to the previous screen.
	Right	Go to the screen which corresponds to the highlighted menu item.
	Enter	Go to the screen which corresponds to the highlighted menu item.

(10) Menu Key

To access the local menu of the DT730G.

(11) Mic Key

To respond handsfree. LED lights during speakerphone operation.

(12) Feature Key

To activate features such as terminal setup, and to program One-Touch Speed Dial Keys.

(13) Answer Key

When LED on this key is lit, press this key to answer a waiting call.

(14) Recall Key

To finish a call and hear the dial tone.

(15) Programmable Keys

These keys can be programmed as Flexible line key/Programmable feature key by System Administrator.

(16) Soft Keys

Any feature shown at the bottom of the LCD is available. The appropriate feature key is displayed on the screen according to the call handling process.

(17) Help Key

To call up explanations of the Soft Keys on the LCD.

Note: *Not all **Help** contents are displayed. For details, contact the System Administrator.*

(18) USB Port

To mount saved data on USB device into the terminal. USB port is on the backside of the terminal.

(19) LCD (Liquid Crystal Display)

Color LCD (ITL-12CG-3) and gray scale LCD (ITL-12DG-3).

(20) Call Indicator Lamp

The lamp at the top corner of DT730G Display flashes when a call terminates to the terminal. Also, when you use Voice Mail service, the Lamp lights when a message has been left.

Installation Procedure

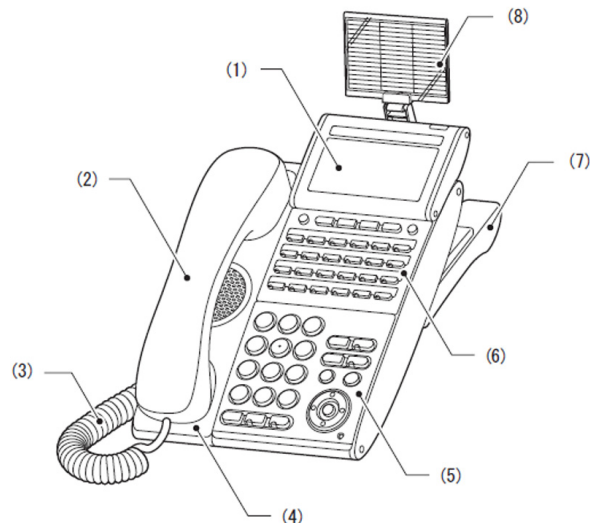

- (1) LCD
- (2) Handset
- (3) Curl Cord
- (4) Handset Cradle
- (5) Numbered Keypad Panel
- (6) DESI Printer Sheet / Line Key Panel
- (7) Tilt Legs
- (8) Directory Card

• Attaching Handset

STEP 1: Insert the modular jack of curled code into the [HANDSET] connector on the backside of the terminal until “click” is heard.

STEP 2: Fit the curled cord into the groove shown.

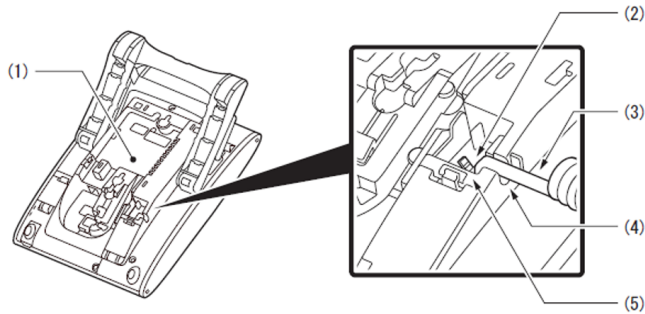

- (1) Terminal
- (2) Modular Jack
- (3) Curl Cord
- (4) Groove
- (5) [HANDSET] Connector

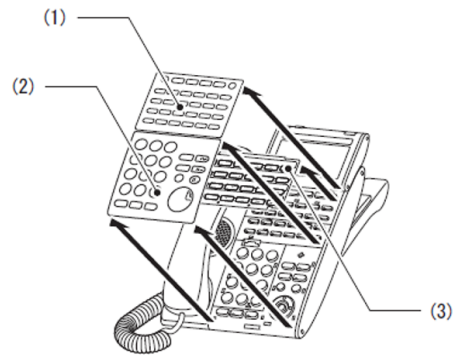

- (1) Line Key Panel
- (2) Numbered Keypad Panel
- (3) DESI Printer Sheet

• Attaching or Removing Faceplate and DESI Printer Sheet

Removing Faceplate and DESI Printer Sheet

Remove DESI Printer Sheet using the following:

- STEP 1: Use the small notch at the lower right corner of the terminal to lift the Faceplate up.
- STEP 2: Remove the Faceplate.
- STEP 1: Remove the DESI Printer Sheet.

Attaching Faceplate and DESI Printer Sheet

- STEP 1: After replacing the DESI Printer Sheet on the terminal, attach the Faceplate.
- STEP 2: At each corner, press the locking pin back into place.

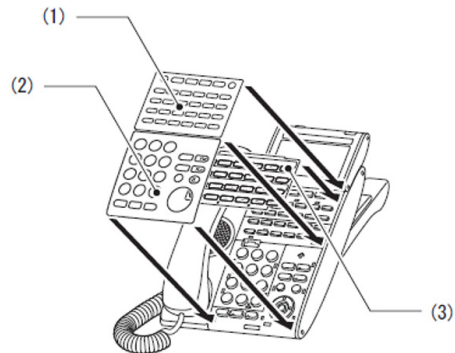

- (1) Line Key Panel
- (2) Numbered Keypad Panel
- (3) DESI Printer Sheet



Attach the Faceplate securely. If not, the terminal will not operate correctly because a key is being pushed by the Faceplate.

• Adjusting Angle of Tilt Legs

The height can be adjusted by moving the legs attached to the bottom of the terminal.

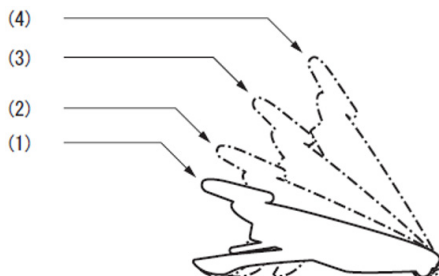

- (1) First Position
- (2) Second Position
- (3) Third Position
- (4) Forth Position

Raising Tilt Legs

STEP 1: Turn the terminal over (key side down).

STEP 2: Raise Tilt Legs to desired height.

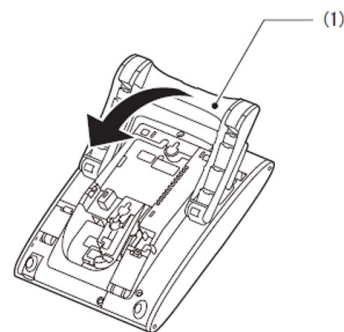

(1) Tilt Legs

STEP 3: Turn the terminal over (key side up).

Lowering Tilt Legs

STEP 1: Turn the terminal over (key side down).

STEP 2: Lower Tilt Legs to desired height.

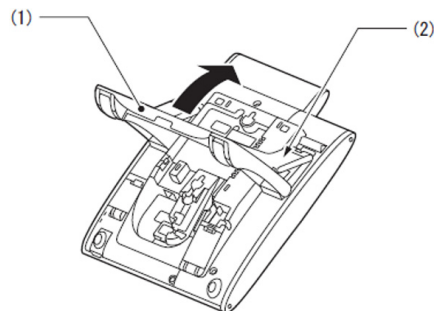

- (1) Tilt Legs
- (2) Stopper

STEP 3: Turn the terminal over (key side up).

• Removing or Attaching Tilt Legs

Removing Tilt Legs

STEP 1: Turn the terminal over (key side down).

STEP 2: Lower the Tilt Legs to first position.
For details refer to [Lowering Tilt Legs](#).

STEP 3: Remove stopper protrusion (a, b) from the groove of the Tilt Legs (A, B) and place them flat against the terminal.

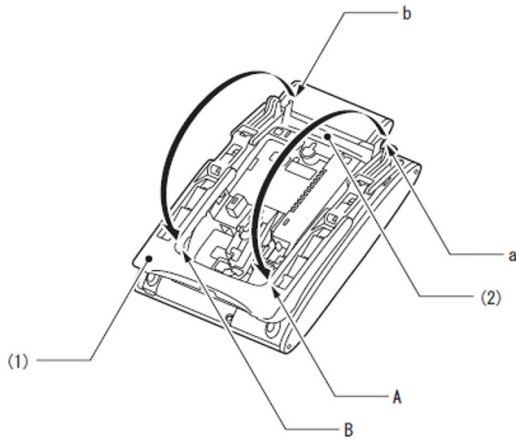

- (1) Tilt Legs
- (2) Stopper

STEP 4: Push downward (c, d) and slide downward.

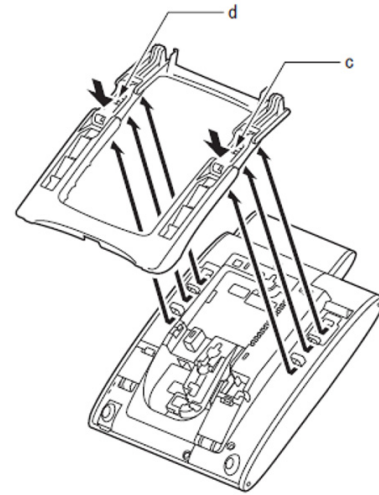

Attaching Tilt Legs

STEP 1: Turn the terminal over (key side down).

STEP 2: Lay the adjustable Tilt Legs on top of the terminal.

STEP 3: Push the Tilt Legs upward until they snap into place.

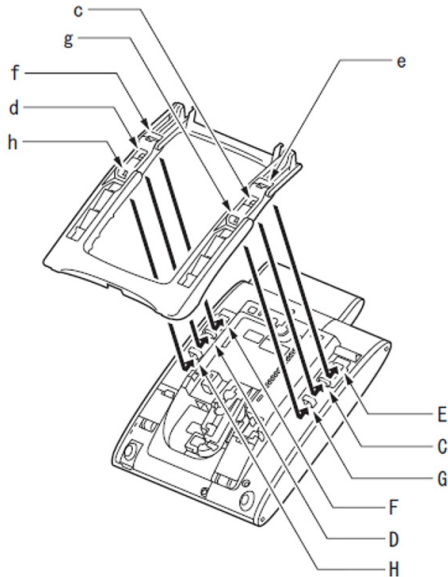

STEP 4: Lift both ends of Tilt Legs until they come together.

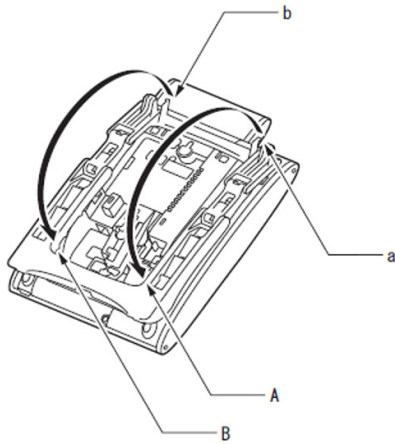

• Connecting LAN Cable

Connect the LAN cable to the terminal using the following:



An ILPA-R UNIT is required when PoE Hub supports NEC Proprietary Protocol (The ILPA-R UNIT converts IEEE802.3af to NEC Proprietary Protocol). When an ILPA-R UNIT is used, the 1000BASE-T is not available. For details, contact the System Administrator.

STEP 1: Plug the power cable into the AC adapter connector when power is supplied with AC adapter. This step is not required when PoE hub is used.

STEP 2: Gently press the cable into the grooved cutout.

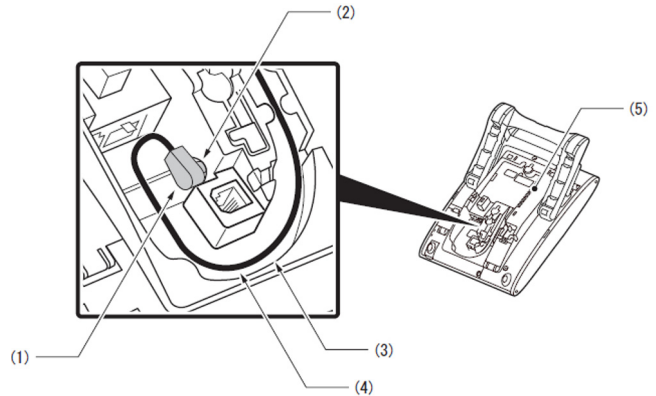

- (1) DC Cable Plug
- (2) AC Adapter Connector
- (3) Groove
- (4) Attached DC Cable
- (5) Terminal

STEP 3: Connect LAN cable to LAN cable connector (LAN (=)) of the terminal.

STEP 4: Press the LAN cable into the groove.

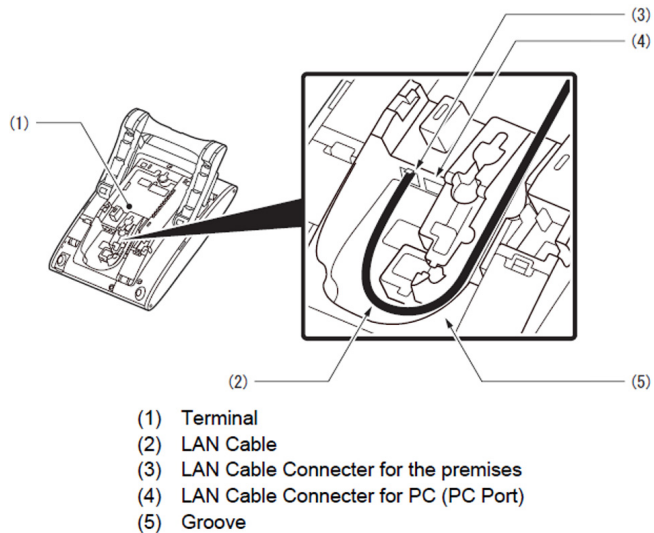

Note: When disconnecting the AC adapter, remove the LAN cable, then disconnect the adapter.

• Attaching Directory Card

The Directory Card can be used to record numbers dialed often or other information.

Note: *Directory Card (VAL DIRECTORY CARD UNIT) is optional.*

- STEP 1: Attach the Directory Card to the Directory Card Holder.
- STEP 2: Take the protective sheet off from the plastic cover.
 The surface of the plastic cover is put out.
- STEP 3: Push the Directory Card Holder into the grooves on the terminal until they snap into place.

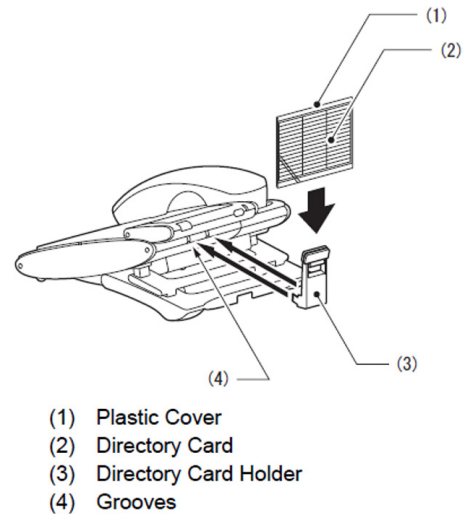

Wall Mounting

Wall mounting the terminal requires the Wall Mount Unit (WM-L UNIT).

• Required Space

Before drilling, refer to the template below for required spacing.

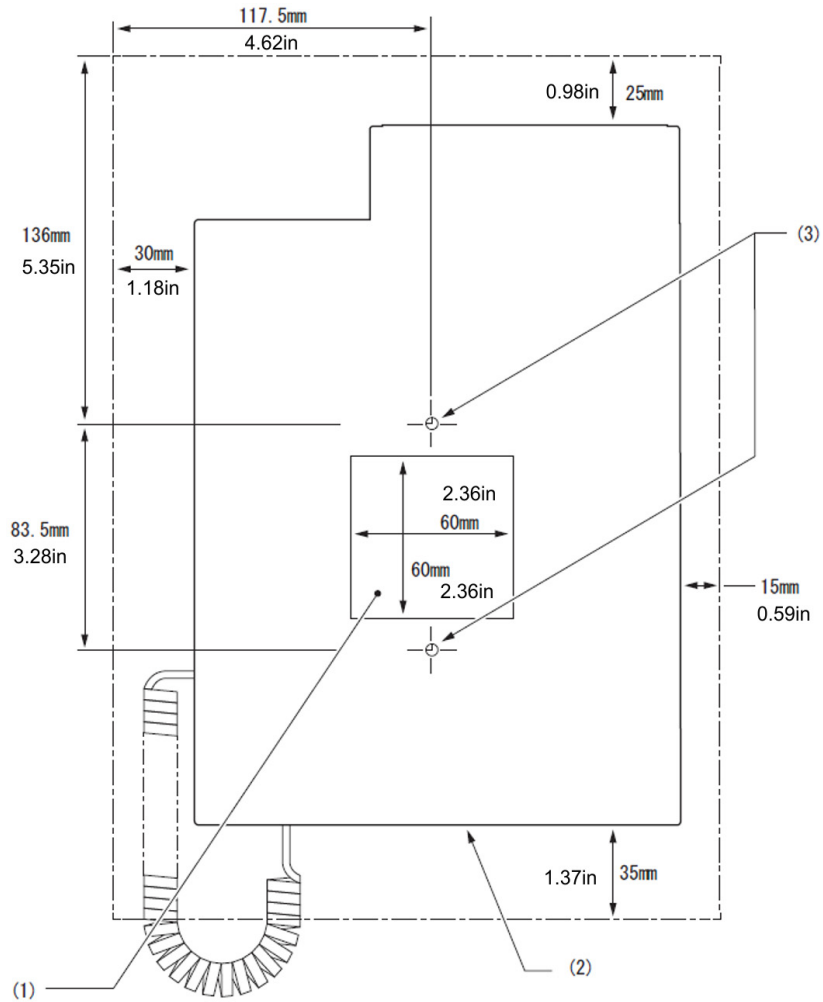

- (1) Cutout for WM-L UNIT
- (2) Outline of Terminal
- (3) Screw Holes for WM-L UNIT

• How to Mount Unit

The following shows the procedure for wall mounting.

STEP 1: Turn terminal over (key side down).

STEP 2: Remove the hanger hook from the terminal, reverse it and reinsert it to the terminal.

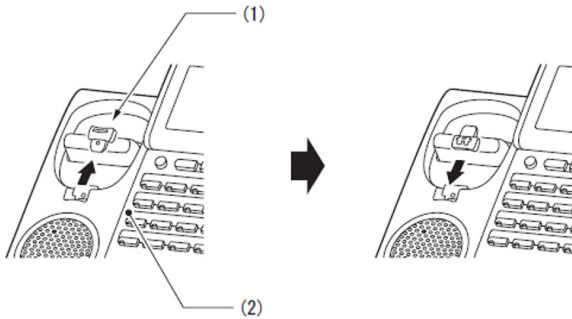

- (1) Hanger Hook
- (2) Terminal

STEP 3: Turn the terminal over, and spread the Tilt Legs.

Refer to steps 1 through 3 of [Removing Tilt Legs](#).

STEP 4: Install the WM-L UNIT on the wall or on the wall plate.

Select one of the following procedures:

- Mount Terminal on Wall using WM-L UNIT
Attach the WM-L UNIT to the wall using six screws or using two wall mounted screws.

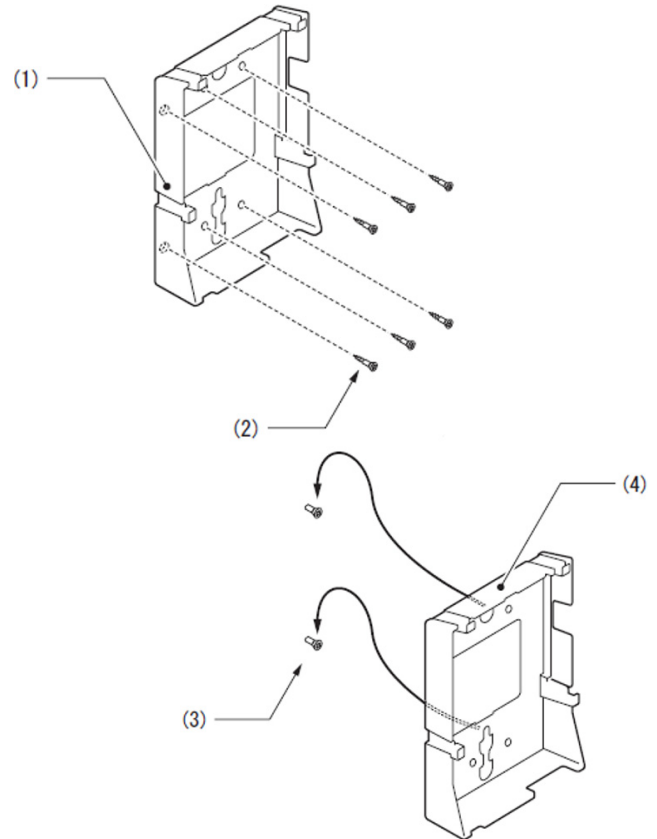

- (1) WM-L UNIT
- (2) Screws (Attached parts)
- (3) Screws (Local supply)
- (4) WM-L UNIT

- Mount Terminal on Wall Plate using WM-L UNIT
Locate the screw holes on the base and hang the cover over the screws on the wall plate.

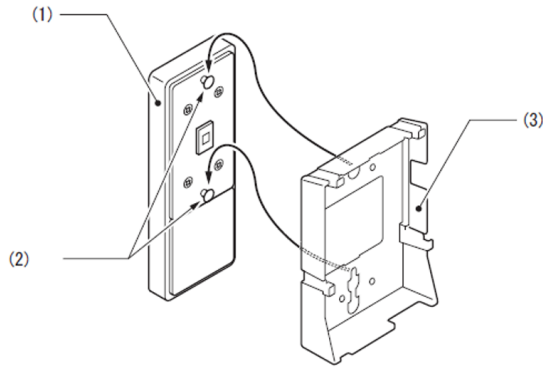

- (1) Wall Plate
- (2) Screws
- (3) WM-L UNIT

STEP 5: Connect the LAN Cable.
Refer to [Connecting LAN Cable](#).

STEP 6: Align the four cutouts on the bottom of the terminal with the tabs on the WM-L UNIT. Plug one end of the line cord into the wall receptacle.

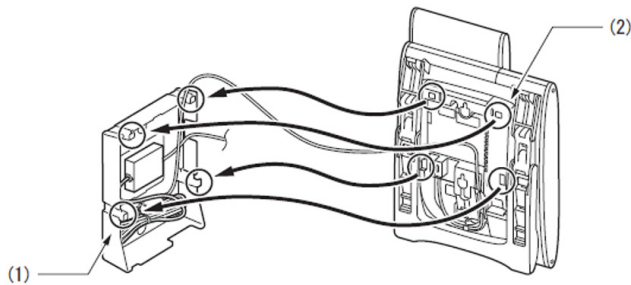

- (1) Tabs
- (2) Cutouts

Phone Start Up and Menu Screen

The screen that is displayed right after starting up the phone depends on whether you start up the phone by using an XML application without its home URL registered or with its home URL registered. This section provides sample screen displays for both cases, and explains how to start up the menu screen.

TIP

HOME URL:

A home URL is the address information of the application that is to be accessed first after the phone is started. Home URL registration is performed at installation. For details, contact the System Administrator.

TIP

PORTAL SCREEN:

A **Portal** screen is the home (entrance) screen of the phone. When you use multiple XML applications, the URL that is registered as the home URL is the **Portal** screen: this is where other XML applications can be accessed. When a home URL is not registered, the default home screen of the phone is the **Portal** screen.

• Starting Up The Phone (without a home URL registered)

- **Desktop** screen is displayed after the phone is started.

TIP

The Desktop screen that is displayed on your phone varies depending on the configuration setting. For details, contact the System Administrator.

Desktop Screen (ITL-12CG-3)

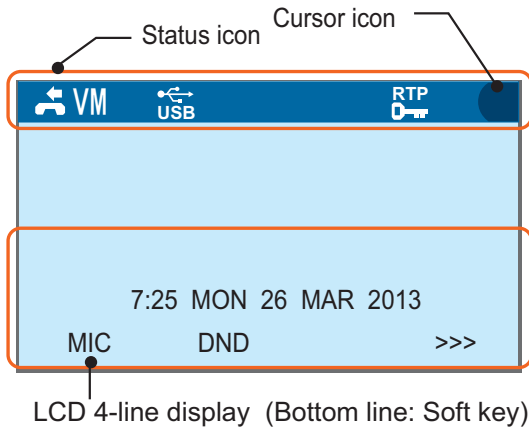

Desktop Screen (ITL-12DG-3)

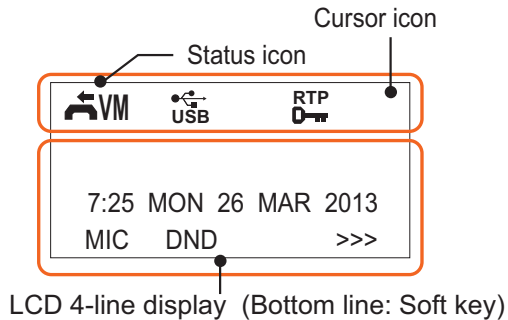

Service/Icon	Description
Status Icon	The LCD of DT730G displays icons which provide notification when events (such as missed call and voice mail) occur. For details of status icons, see Status Icons .
LCD 4-line display	Displays LCD information sent from the system.

- Press **Menu** to display the menu screen.
The screen displayed as the **Portal** icon is the **Desktop** screen.

Menu Screen (ITL-12CG-3)

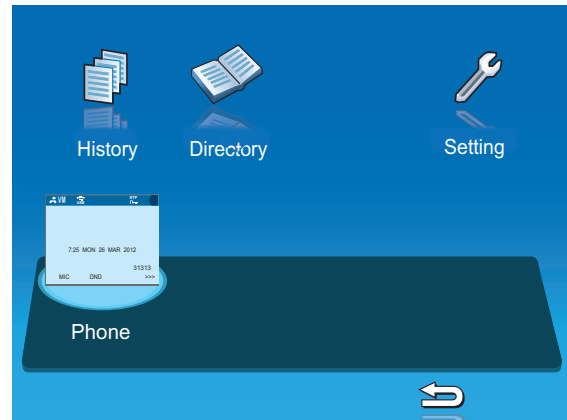

Menu Screen (ITL-12DG-3)

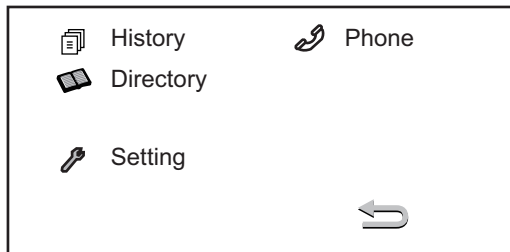

- Press **Menu** to display the menu screen.

The screen displayed as the **Portal** icon is the screen of the XML application that is registered as the home URL.

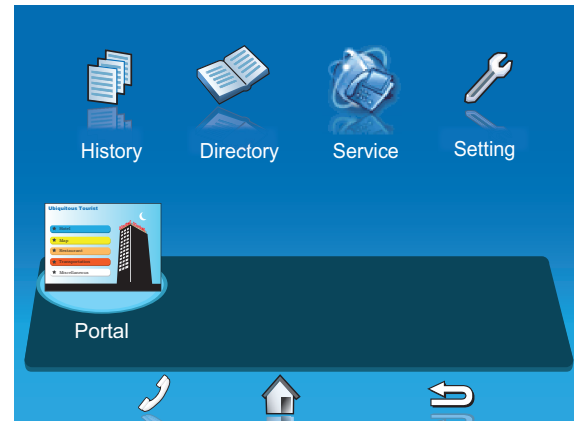

- **Starting Up The Phone (with a home URL registered)**

The phone automatically accesses the home URL, and displays the received XML application as the Portal screen.

Note: *The following XML application screen and the Portal screen icon are samples. The actual screen that is displayed on your phone may vary depending on the application used.*

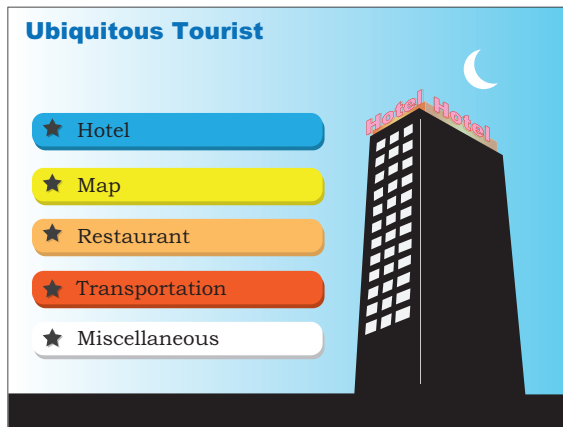

Note: *Normally, the name of the Portal screen icon is displayed as the name of the registered application.*

- **Menu Screen**

From **Menu**, you can use various application features such as **Directory** and **History**.

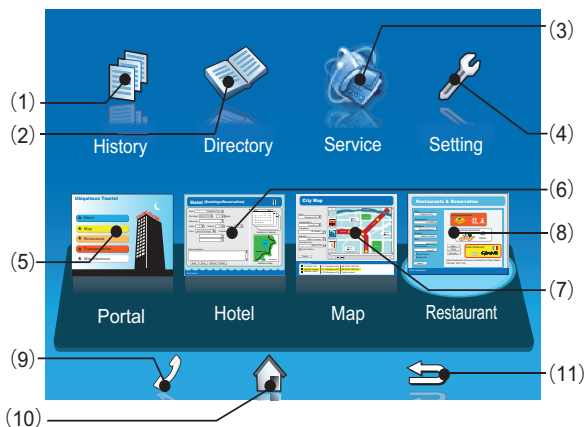

[ITL-12CG-3]



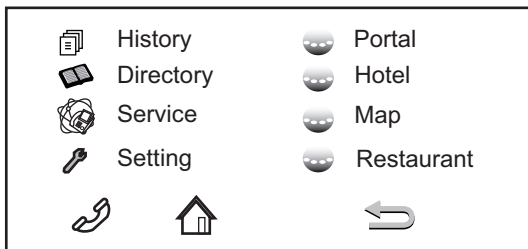





[ITL-12DG-3]



	Menu/Icon	Description
Local Application	(1) History CG: DG:	To view Call History ; the history data stored in the server (system) memory (see Lowercase Character) and that stored in the memory of the telephone, such as the histories of missed calls, dialed numbers, and received calls (see 5.CALL HISTORY OPERATION).
	(2) Directory CG: DG:	To use Directory features; there are three types of directory features. <ul style="list-style-type: none"> • Personal Directory: Controlled by telephone set. For details, see 4.DIRECTORY OPERATION. • Phonebook: Controlled by the system. For details, see Phonebook. • Corporate Directory: Controlled by the external XML server. For details, contact the System Administrator.
	(3) Service CG: DG:	XML application screen registered in the service URL is displayed. When the service URL is not registered, Service icon is not displayed.
	(4) Setting CG: DG:	To make the user settings of DT730G such as incoming call and display, and download various files such as ringtones, Music on Hold, and directories. For details, see 2.TERMINAL SETUP .

	Menu/Icon	Description
XML Services	(5) Phone/ Portal CG: 	When the home URL is not registered, Phone screen icon is displayed.
	DG: 	When the home URL is registered, a screen icon of XML application which was registered as the home URL and the application name (Portal) are displayed.
	(6) XML application 1	You can launch up to four XML applications including the Portal screen at a time. The icons of the running applications are displayed on the Menu screen from the left. For details, see Multi-Window .
	(7) XML application 2	
(8) XML application 3		

	Menu/Icon	Description
Soft Keys	(9) Phone icon CG:  DG: 	When you select the Phone icon, a pop-up screen is displayed on an XML application screen. (For details, see Pop-up Windows . When XML application is registered in the home URL, the phone icon is displayed. When a home URL is not registered, the phone icon is not displayed. Note: <i>If pop-up window display is disabled at installation, this icon is not displayed.</i>
	(10) Home URL icon CG:  DG: 	XML application screen registered in the home URL is displayed. When the home URL is not registered, Home URL icon is not displayed.
	(11) Back icon CG:  DG: 	When you select the Back icon, you can go back to the previous screen.

TIP

By selecting an application icon using cursor key and press enter key, you can launch the application of Local Application/XML Service from the menu. Also you can launch the application of Local Application/XML Service directly by pressing digit key (1 ~ 8).

• Starting Up XML Application

DT730G has an XML browser function. You can display the information of XML application installed in an external server onto the LCD of DT730G and use various services in collaboration with the XML application.

The following explains how to start the XML application from DT730G. For more information, refer to manuals relating to XML applications.

To Start Up from Menu Button

STEP 1: Select **Service**.

Select an item by one of the following operations.

- Highlight an item by using cursor key, and press , or **OK**.
- Press **3**.

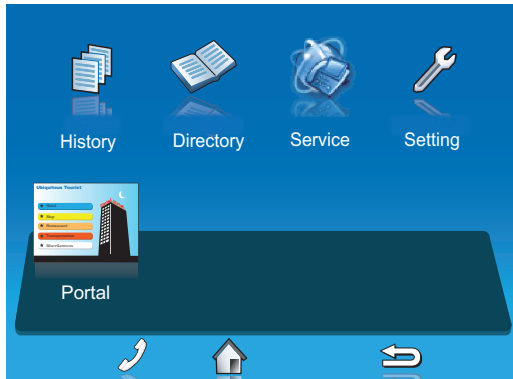

STEP 2: XML Application will start up.



Shortcut Menu

The LCD displays icons when there are missed calls or new voice mails. You can open shortcut menu by pressing  (**Enter**). You can also check missed calls or access the new voice mails from shortcut menu.

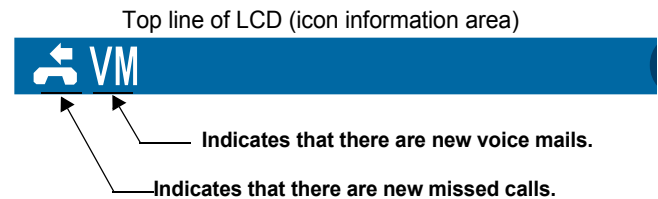

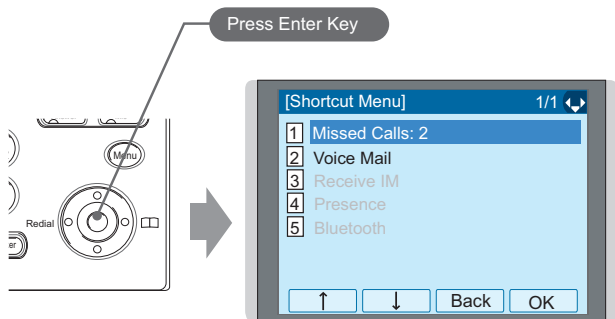

Note: *Unavailable Menu items are grayed out.*

Operation List

Feature	Description
1 Call History	
2 Contacts	
3 User Features	
4 Phone Setting	
5 System Setting	
Properties	

• Status Icons

The LCD displays icons in the icon information area when there are missed calls or new voice mails. You can check the status at a glance, and access the services quickly.

The following icons are displayed:

Feature	Icon	Description
Missed Call		This icon appears when there is a missed call. Once you check the missed call, this icon will disappear.
Voice Mail		This icon provides notification of incoming Voice Mail. Once you check the mail, this icon will disappear.
USB Connection		When an USB device is connected to the terminal, this icon will appear.
USB Caution		If an USB device is in abnormal condition, such as when overcurrent of USB device is detected, this icon will appear.
Encryption		This icon appears when the conversation is encrypted.
Cursor		This icon indicates the currently available direction of the cursor. This icon is displayed in the menu screen.

Note: For **USB Caution icon:**

When overcurrent of USB device is detected, power supply to the USB port will be suspended. To restart the power supply, remove the USB device and reboot the terminal by turning OFF/ON the power of terminal.

- *When using Power Hub (When AC adapter is not used), unplug and plug the LAN cable connected to the terminal.*
- *When using AC adapter, unplug and plug the AC adapter after disconnecting the LAN cable connected to the terminal.*

Also, when disconnecting/connecting the LAN cable, be sure not to confuse the cable for LAN port with the cable for PC port.

Soft Keys

Soft Keys on DT730G provide a set of functions on the LCD that adapts to the changing state of the telephone.

Note: *Patterns and names of Soft Keys to be displayed are set at installation. For details, contact the System Administrator.*

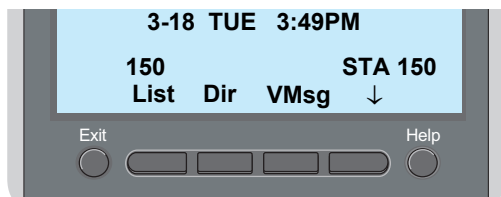

- **Display Samples**

Soft Keys provide a set of functions on the LCD that adapts to the changing state of the telephone.

IDLE



DIAL TONE/DIALING

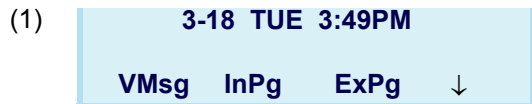

Push ↓ (Down Arrow)



RINGING

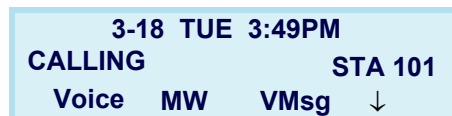

BUSY

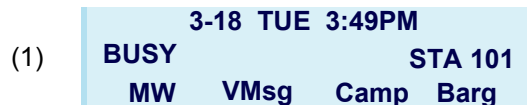

CONNECTION

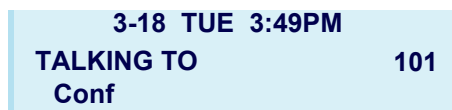

CONSULTATION HOLD

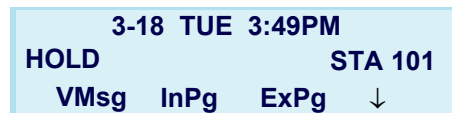

- **How to Use Soft Keys**

This section provides some sample operations of features using **Soft Keys**.

Example 1: DO NOT DISTURB

STEP 1: Press ↓ (Down Arrow).

```
3-18 TUE 3:49PM
150 STA 150
List Dir VMsg ↓
```

STEP 2: Press **Prog**.

```
3-18 TUE 3:49PM
150 STA 150
ICM Prog ↑
```

STEP 3: Press **DND**.

```
PGM/SAVE-MENU
Cfwd DND STA ↓
```

STEP 4: Press **Set** to set DND or **Cncl** to cancel it.

```
SET DND
Set Cncl
```

Example 2: CALL FORWARD

STEP 1: Press ↓ (Down Arrow).

```
3-18 TUE 3:49PM
150 STA 150
List Dir VMsg ↓
```

STEP 2: Press **Prog**.

```
3-18 TUE 3:49PM
150 STA 150
ICM Prog ↑
```

STEP 3: Press **Cfwd**.

```
PGM/SAVE-MENU
Cfwd DND STA ↓
```

STEP 4: Select the Call Forward type.

```
Call Forward
All Both BUSY ↓
```

STEP 5: Press **SET** to set Call Forward or **CNCL** to cancel.

```
SET FORWARD
SET CNCL
```

Multi-Window

DT730G can display multiple windows at a time.

As it is possible to launch multiple applications simultaneously, you can switch the displays quickly. If you receive an incoming call while displaying an application screen, you can operate line keys without exiting other applications first.

You can go back to the previous application screen after operating the line keys.

- **Switching XML Applications**

The windows of the XML applications that are currently running are displayed as icons on the menu screen.

You can use this screen to switch windows to display. Select a service icon of the application that are currently running from the menu screen to display the XML application window.

[ITL-12CG-3]

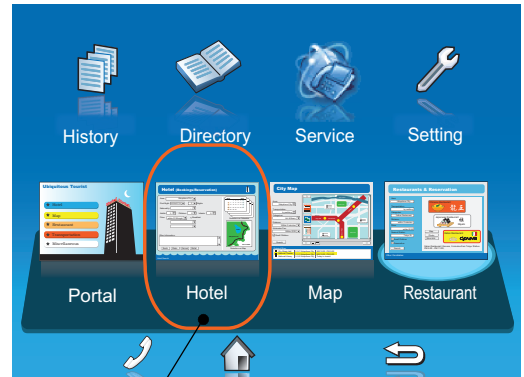

Select a service icon of the XML application to display.

[ITL-12DG-3]

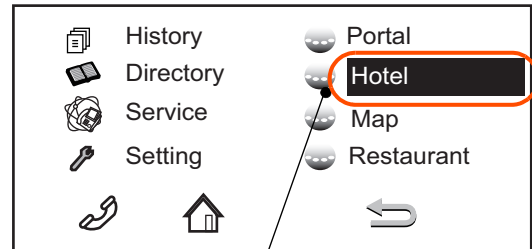

Select a service icon of the XML application to display.

TIP

You can exit an XML application by pressing **Exit** while the LCD displays the XML application window. When you exit an XML application, the icons of other applications that are currently running are rearranged from left.

- Normally, only the Portal icon is displayed on the Desktop screen right after the phone is set up.

[ITL-12CG-3]

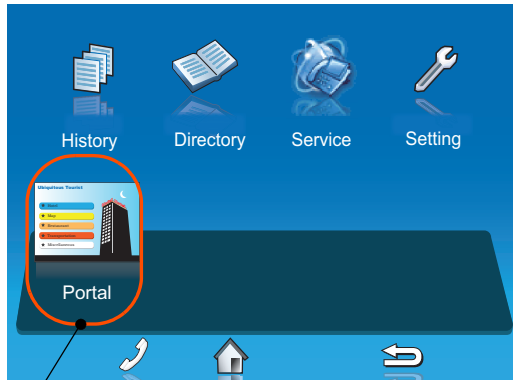

When a home URL is registered:

[ITL-12DG-3]

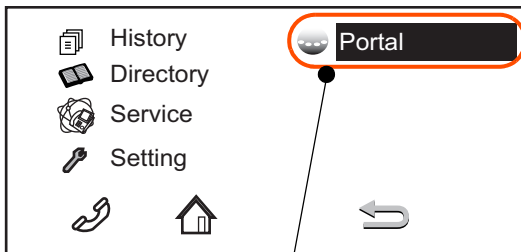

When a home URL is registered:

- When you launch an XML application, the icon of the application appears to the right of the **Portal** icon on the **Desktop** screen.

[ITL-12CG-3]

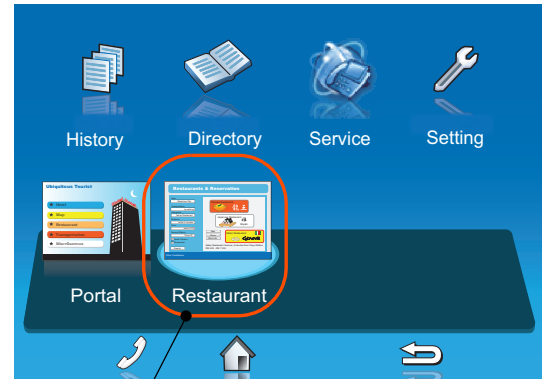

Displays the icon of the newly running XML application

[ITL-12DG-3]

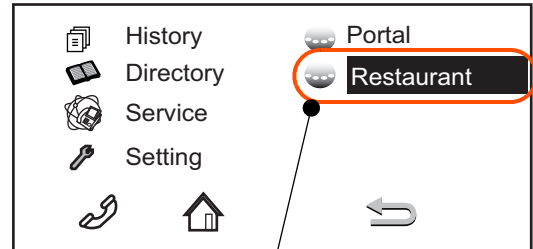

Displays the icon of the newly running XML application

- You can launch up to four XML applications including the **Portal** window. The service icons of the running applications are displayed from the left in order of their launch.

[ITL-12CG-3]

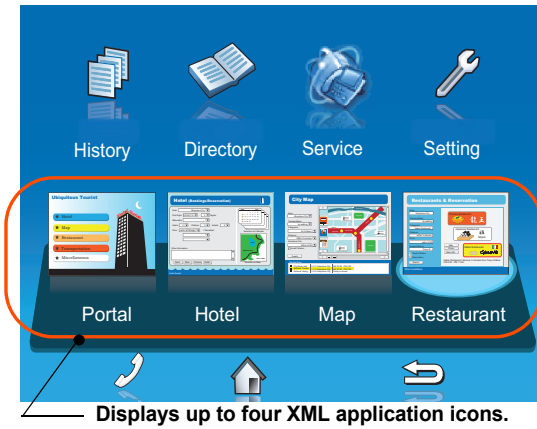

[ITL-12DG-3]

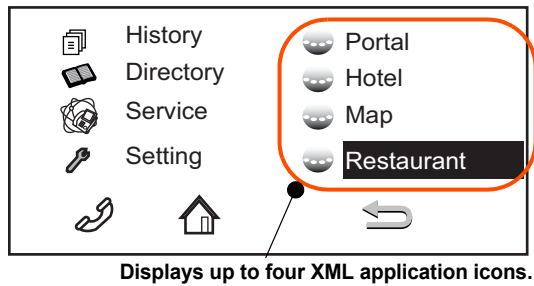

TIP

If you launch the same XML application more than once, only one icon of the application is displayed on the menu screen.

• **Switching Local Applications**

Local applications such as **History**, **Directory**, and **Setting** are displayed in one window.

[ITL-12CG-3]

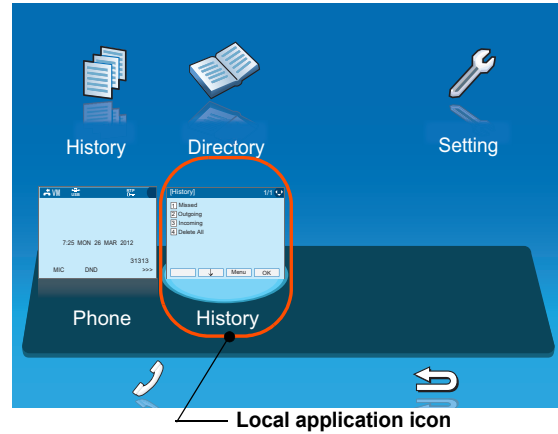

[ITL-12DG-3]

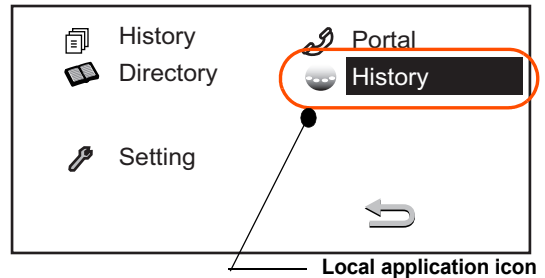

- Normally, only the **Portal** icon is displayed on the **Desktop** screen right after the phone is set up.

[ITL-12CG-3]

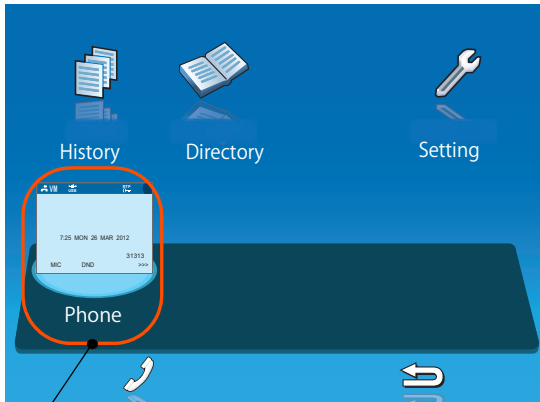

When a home URL is not registered:

[ITL-12DG-3]

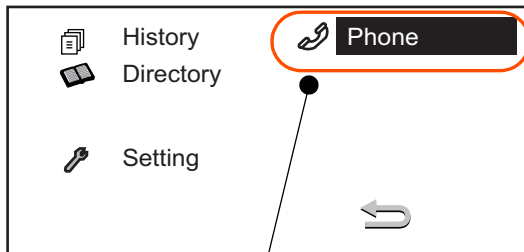

When a home URL is not registered:

- Select a desired local application from icons to launch the application or setting **Menu**.

[ITL-12CG-3]

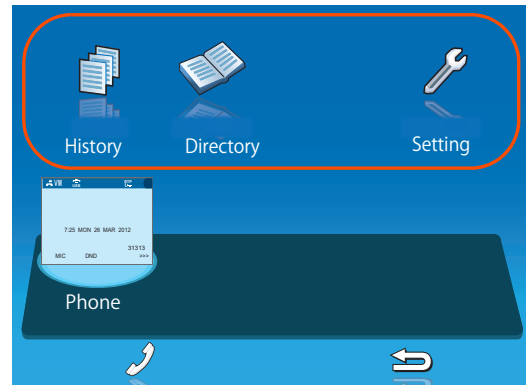

[ITL-12DG-3]

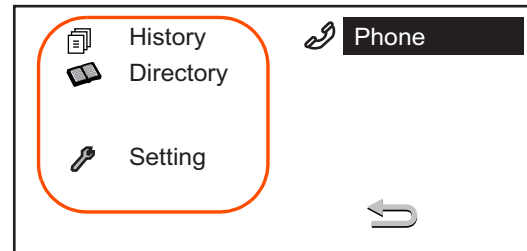

- If you stop operating the local application without exiting the application and press **Menu**, **History** icon is added to the right of the **Portal** icon. This icon shows the last screen you used. By selecting this icon, you can continue the operation of the application where you ended.

[ITL-12CG-3]

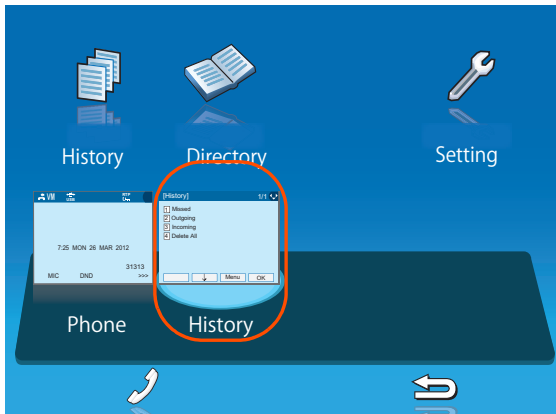

[ITL-12DG-3]

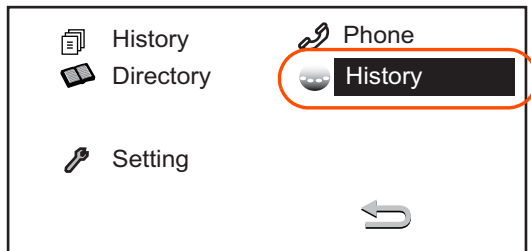

TIP

If you select a local application by using a One-Touch key while launching other local application, new local application is not running. The initial screen of the currently running application is displayed.

• Launching the Fifth Application

You can launch up to four XML applications including **Portal** at a time. If you try to launch a fifth application, an error message to ask you to exit one of the currently running applications is displayed. While this error message is displayed, you cannot execute any operations on XML applications.

- If you try to launch a fifth application, an error message to ask you to exit one of the currently running applications is displayed.

Press **Next**.

[ITL-12CG-3]

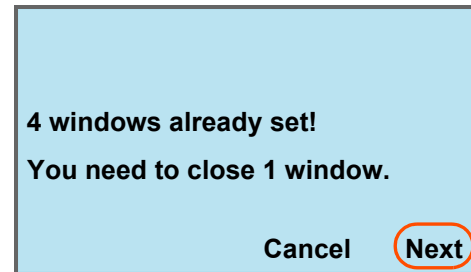

[ITL-12DG-3]

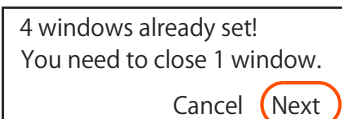

TIP

If you do not operate anything for 10 seconds after an error message is displayed, the trial of launching the new application is automatically canceled.



- Application exit screen is displayed. Currently running XML application icons excluding the **Portal** are displayed. Select an application to exit. Now you can launch a new application.

[ITL-12CG-3]

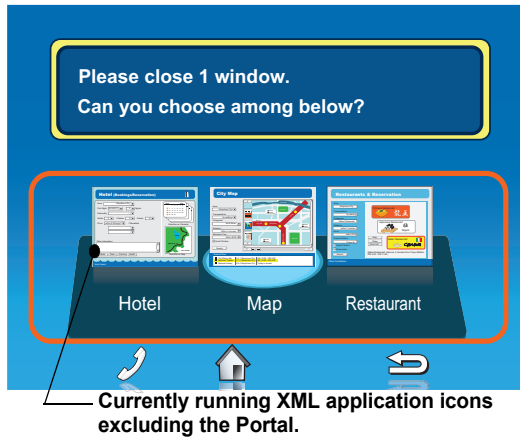

[ITL-12DG-3]

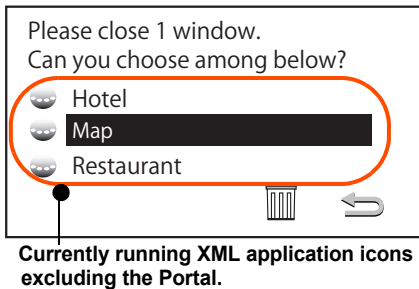

- The icon for the application you quit disappears from the menu screen. The newly running application icon is added to the right.

[ITL-12CG-3]

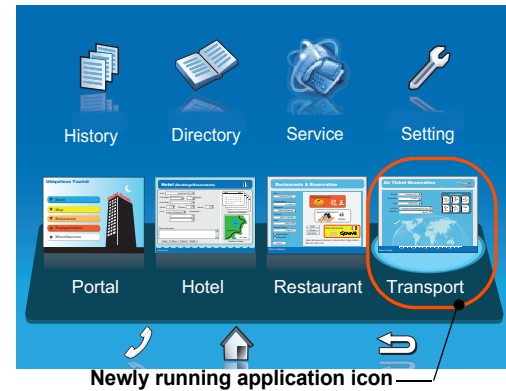

[ITL-12DG-3]

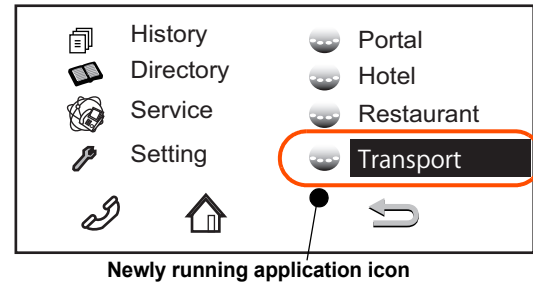

- **Icon Display at XML Application Update**

The service icons displayed on the menu screen are reduced screen images of actual XML application screens. The icon and the actual application display may differ because the system cannot iconize the screen image until it actually displays the application windows.

NEW icon is displayed when the application orders to display an icon that was formerly not displayed.

UPDATE icon is displayed when the window of the XML application is updated.

[ITL-12CG-3]

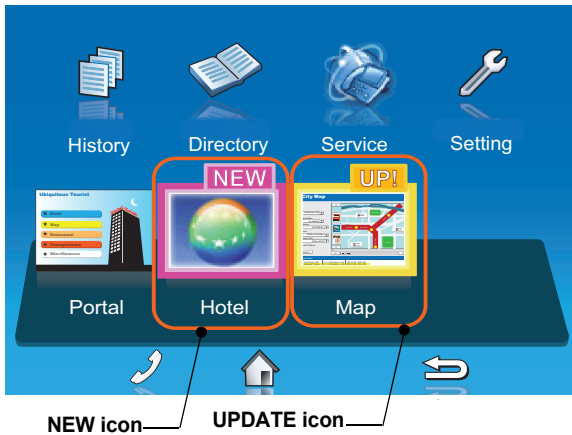

TIP | **NEW** and **UPDATE** icons flash every second.

[ITL-12DG-3]

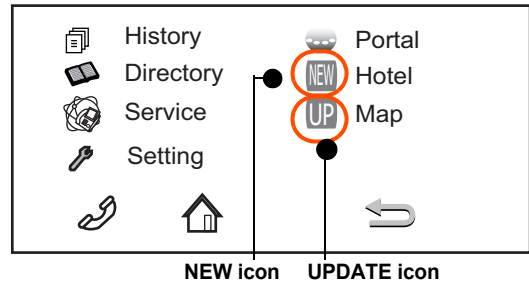

TIP | **NEW/UPDATE** icon and **Application** icon appear alternately every second.

Pop-up Windows

If there is an incoming call while the phone is displaying an XML application, or a local application such as **History** or **Directory**, a telephone service window appears as a pop-up window.

[ITL-12CG-3]

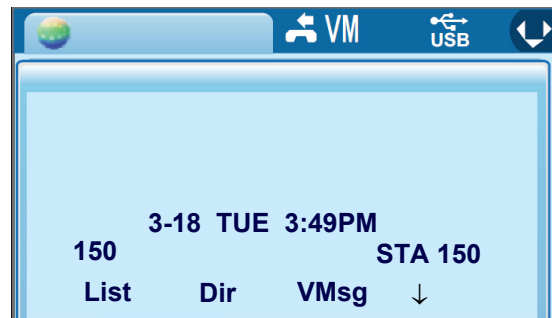

[ITL-12DG-3]

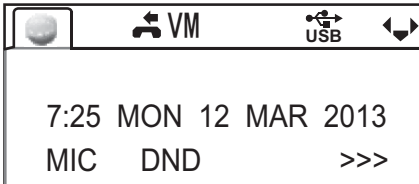

• Launching a Pop-Up Window

There are several ways to display a pop-up window as listed below.

TIP

A procedure how to display a pop-up window is set at installation. For details, contact the System Administrator.

How to Display

By selecting Phone icon on the menu screen.
When there is an incoming call to the phone.
By going off-hook. (lifting the handset, etc.)
When receiving a request from the XML application server.
By pressing POP-UP on an XML application.
When the system directs resource release.
By pressing Help key on the menu screen

TIP

If the previous page of the menu screen is the default home screen, the telephone icon of the menu screen will not be displayed.

TIP

When using Help key on the POP-UP window, Help key operation setting is required. For details, see [Set Usability](#).

• Exiting a Pop-Up Window

A pop-up window closes when:

- **Menu** is pressed to display the menu screen.
- The phone goes on-hook.
- The call is abandoned before being answered.
- XML application server directs to do so.
- **Pop-Up Close** on the XML application is pressed.

This page is for your notes.

2. TERMINAL SETUP

This chapter describes operating procedures for terminal settings. Various terminal settings such as display, sounds, password and language are available.



Setup With Up/Down Key

- **Adjust Handset Receiver Volume**

STEP 1: Press  (Up) or  (Down) in the off-hook status or during a call.



- **Adjust Speaker Volume**

STEP 1: Press  (Up) or  (Down) during speakerphone operation or during a call.

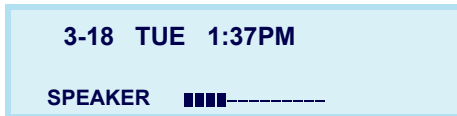

- **Adjust Ringer Tone**

STEP 1: Press  (Up) or  (Down) during ringing.

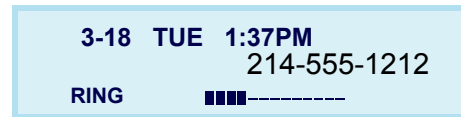

- **Adjust LCD Contrast (ITL-12DG-3)**

STEP 1: Press the **Up/Down** key in the on-hook status.

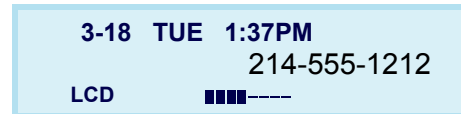

Note: LCD contrast adjustment is only for ITL-12DG-3.

Setup With Feature Key

- **Microphone On/Off**

STEP 1: LED on  shows the status of the built-in microphone.

STEP 2: Press the MIC key or press  and **1**.

Setup with Menu Key



- **Enable/Disable Off-Hook Ringing**

The procedure below shows how to enable/disable Off-hook ringing.

STEP 1: Display the **Menu** screen, select **Setting**.

STEP 2: Select **1 User Setting**.

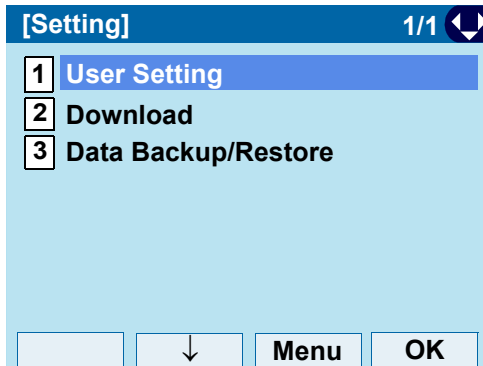

Select an item by one of the following operations.

- Highlight an item by using , and press ,  or **OK**.
- Press **1**.



STEP 3: Select **1 Incoming Call**.

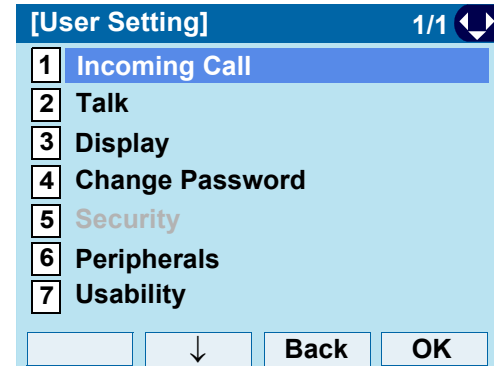

Select an item by one of the following operations.

- Highlight an item by using , and press ,  or **OK**.
- Press **1**.



STEP 4: Select **2 Offhook Ring**.

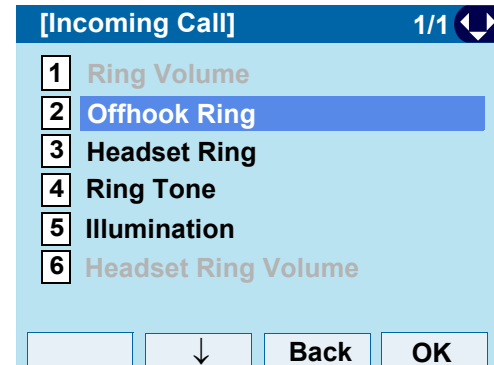

Select an item by one of the following operations.

- Highlight an item by using , and press ,  or **OK**.
- Press **2**.



STEP 5: To disable/enable the off-hook ringing, choose **1 Disable** or **2 Enable**.

Select an item by one of the following operations.

- Highlight an item by using , and press  or **OK**.
- Press **1** or **2**, and press  or **OK**.

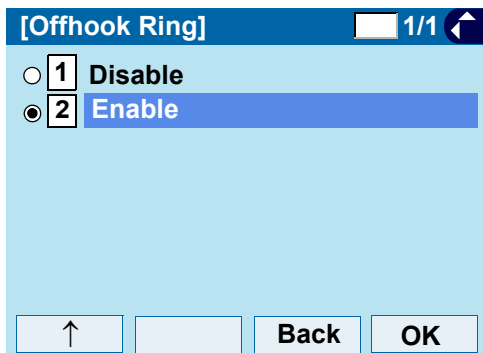

TIP Default setting is **Enabled**.

TIP The enabled item is highlighted.



• Set Ringing of Headset

The procedure below shows how to enable/disable the ringing of headset.

STEP 1: Display the **Menu** screen, select **Setting**.

STEP 2: Select **1 User Setting**.

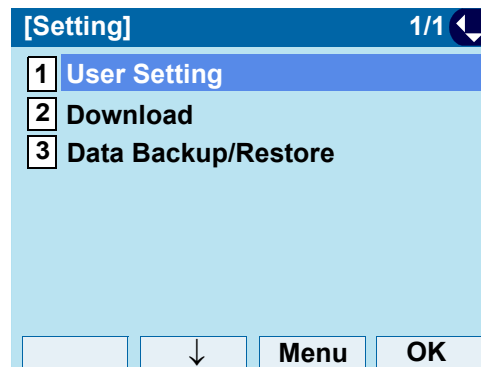

Select an item by one of the following operations.

- Highlight an item by using , and press ,  or **OK**.
- Press **1**.





STEP 3: Select **1 Incoming Call**.

Select an item by one of the following operations.

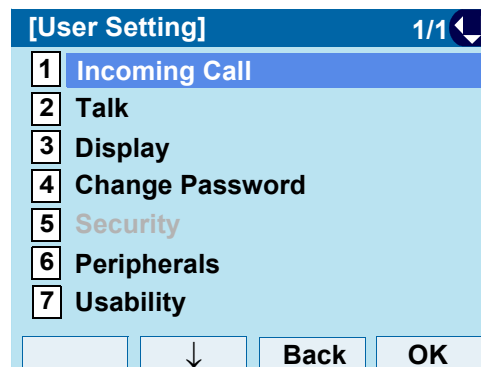
- Highlight an item by using , and press ,  or **OK**.
- Press **1**.





STEP 4: Select **3 Headset Ring**.
Select an item by one of the following operations.

- Highlight an item by using , and press , or **OK**.
- Press **3**.



STEP 5: To disable/enable the ringing of headset, choose **1 Disable** or **2 Enable**.

Select an item by one of the following operations.

- Highlight an item by using , and press , or **OK**.
- Press **1** or **2**, and press , or **OK**.

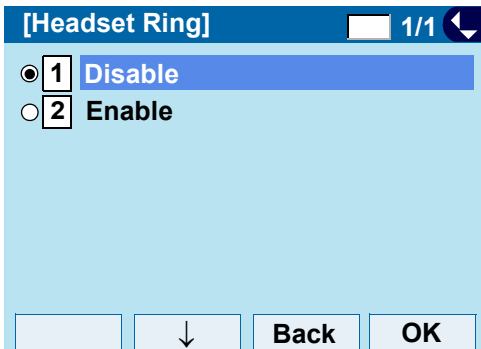

TIP | Default setting is **Disabled**.



• To Set Ringer Tone

The procedure below shows how to change the ringer tone for internal call and external call.

STEP 1: Display the **Menu** screen, select **Setting**.

STEP 2: Select **1 User Setting**.

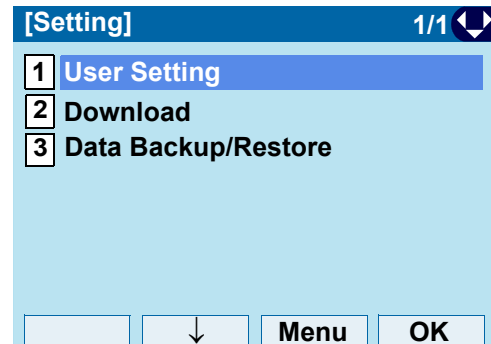

Select an item by one of the following operations.

- Highlight an item by using , and press , or **OK**.
- Press **1**.



STEP 3: Select **1 Incoming Call**.

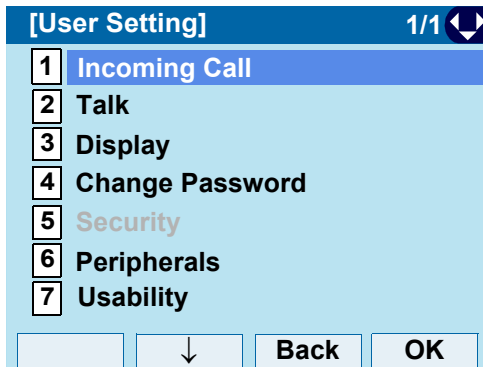

Select an item by one of the following operations.

- Highlight an item by using , and press ,  or **OK**.
- Press **1**.



STEP 4: Select **4 Ring Tone**.

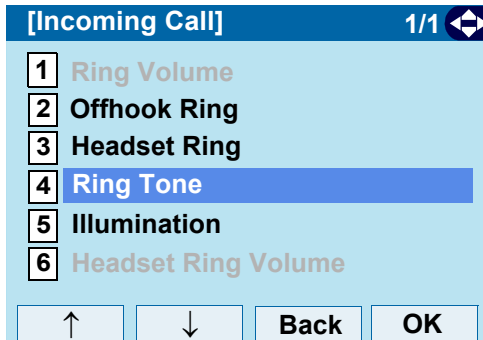

Select an item by one of the following operations.

- Highlight an item by using , and press ,  or **OK**.
- Press **4**.



STEP 5: Select **1 External Call** when setting the ringer tone for external calls. Select **2 Internal Call** when setting the ringer tone for internal calls.

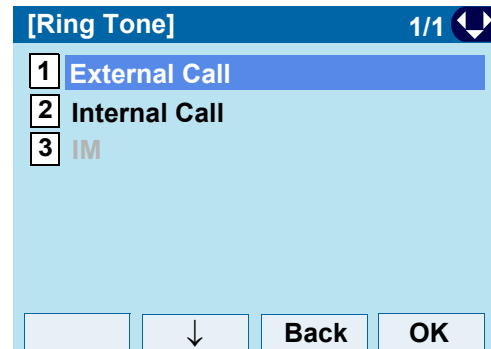

Select an item by one of the following operations.

- Highlight an item by using , and press ,  or **OK**.
- Press **1** or **2**.



STEP 6: Select a desired tone type. You can preview designated ringer tone.

Select an item by one of the following operations.

- Highlight an item by using , and press  or **OK**.
- Press the digit key of desired number, and press  or **OK**.

For example, press **1** + **5** to select **15 Download 1**.

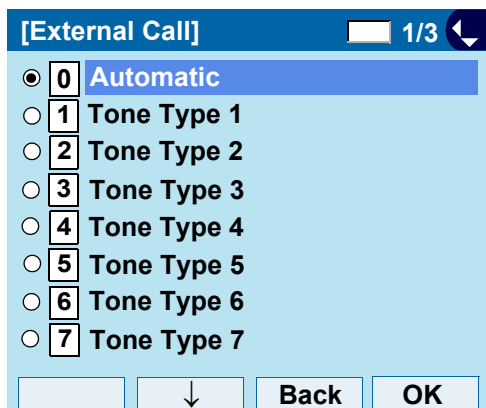

No.	Menu Item	Frequency (Hz)		Remarks
		1st	2nd	
0	Automatic	520	660	16Hz modulation
1	Tone Type 1	520	660	16Hz modulation
2	Tone Type 2	520	660	8Hz modulation
3	Tone Type 3	1400	1100	Door Phone
4	Tone Type 4	1100		No modulation
5	Tone Type 5	540		No modulation
6	Tone Type 6	1100	1400	16Hz modulation
7	Tone Type 7	660	760	16Hz modulation
8	Tone Type 8	1100		Envelope
9	Tone Type 9	–		Door Phone Melody
10	Tone Type 10	–		Melody 1
11	Tone Type 11	–		Melody 2
12	Tone Type 12	–		Melody 3
13	Tone Type 13	–		Melody 4
14	Tone Type 14	–		Melody 5

No.	Menu Item	Frequency (Hz)		Remarks
		1st	2nd	
15	Download 1	–		
16	Download 2	–		
17	Download 3	–		

Note: When selecting *Automatic* or not performing this ringer tone setting, **Tone Type 1** is automatically applied.

Note: When selecting *Automatic*, the preview function will not operate. Also, when selecting **Download 1/2/3**, the ringer tone file must be downloaded in advance. If there is no downloaded file, you hear no tone.

Note: **Tone Type 1 to Tone Type 8:**
In the preview function, each ringer tone sounds continuously. Actual ringer pattern of each tone is determined by the initial system settings.

Note: Terminal settings may not become effective, according to the system settings. For details, contact the System Administrator.

TIP The enabled item is highlighted.



You can set the ringer tone for the telephone here. Ringer Tone type can be set for **Name**, **Group** and **Telephone set**. The ringer Tone type set for **Name** has higher priority than the types set for **Group** and **Terminal set**.

- **Set Illumination Pattern for Call Indication Lamp**

The procedure below shows how to set the illumination pattern (color of Call Indicator Lamp).



STEP 1: Display the **Menu** screen, select **Setting**.

STEP 2: Select **1 User Setting**.
Select an item by one of the following operations.

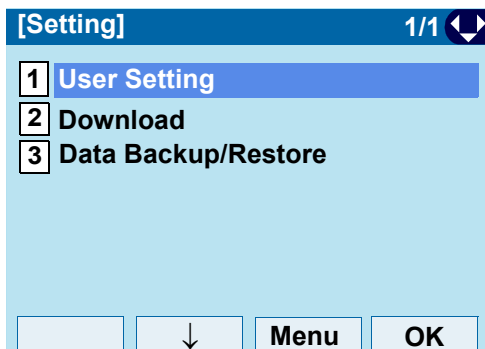
- Highlight an item by using , and press ,  or **OK**.
- Press **1**.



STEP 3: Select **1 Incoming Call**.
Select an item by one of the following operations.

- Highlight an item by using , and press ,  or **OK**.
- Press **1**.

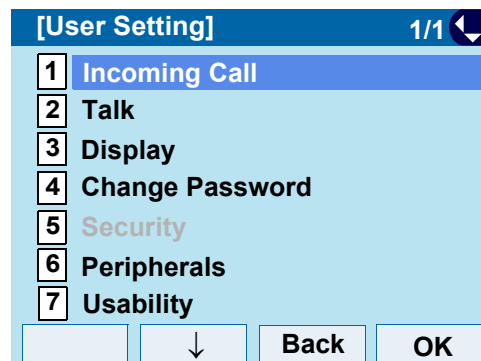

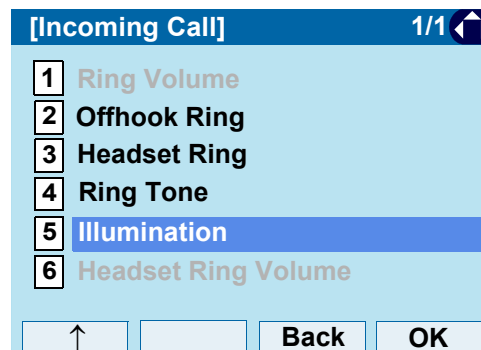

STEP 4: Select **5 Illumination**.
Select an item by one of the following operations.

- Highlight an item by using , and press ,  or **OK**.
- Press **5**.



STEP 5: Select **1 External Call** when setting the illumination pattern for external calls. Select **2 Internal Call** when setting the illumination pattern for internal call. Select an item by one of the following operations.

- Highlight an item by using , and press ,  or **OK**.
- Press **1** or **2**.

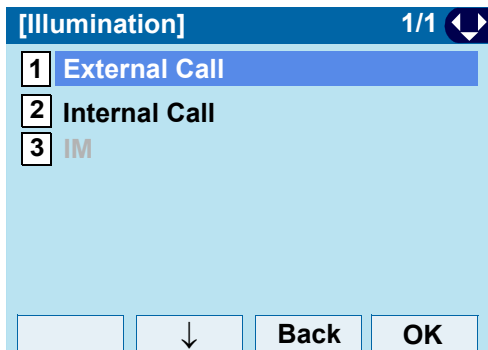

STEP 6: Select a desired illumination pattern. You can preview the designated illumination pattern.

Select an item by one of the following operations.

- Highlight an item by using , and press  or **OK**.
- Press **0** - **9**, and press  or **OK**.

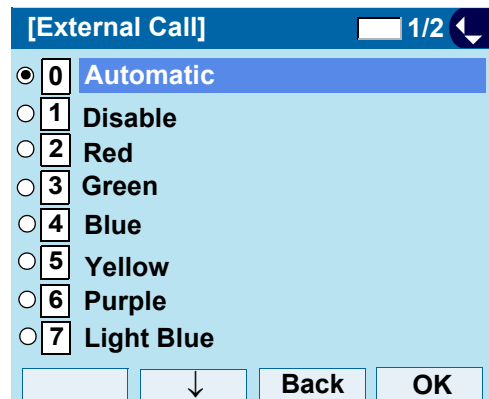

Note: When selecting *Automatic*, the preview function will not operate.

Note: When selecting *Automatic* or not performing this illumination setting, *Red* is automatically applied.

TIP

You can set the illumination pattern for the telephone here. Illumination pattern can be set for **Name**, **Group** and **Telephone set**. The illumination pattern set for **Name** has higher priority than the patterns set for **Group** and **Terminal set**.



- **Enable/Disable RTP Alarm**

The procedure below shows how to enable/disable RTP alarm.

STEP 1: Display the **Menu** screen, select **Setting**.

STEP 2: Select **1 User Setting**.

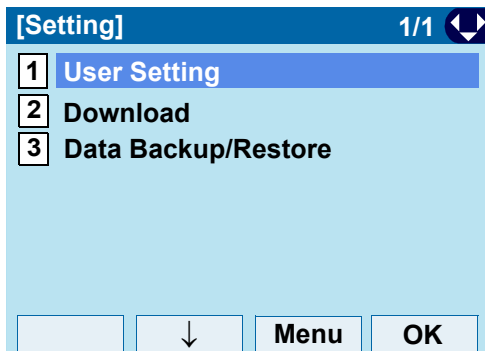

Select an item by one of the following operations.

- Highlight an item by using , and press ,  or **OK**.
- Press **1**.



STEP 3: Select **2 Talk**.

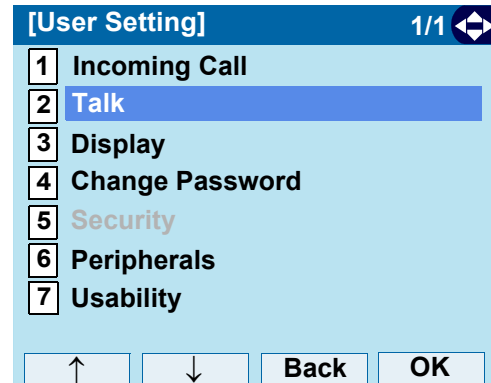

Select an item by one of the following operations.

- Highlight an item by using , and press ,  or **OK**.
- Press **2**.



STEP 4: Select **1 RTP Alarm**.

Select an item by one of the following operations.

- Highlight an item by using , and press ,  or **OK**.
- Press **1**.

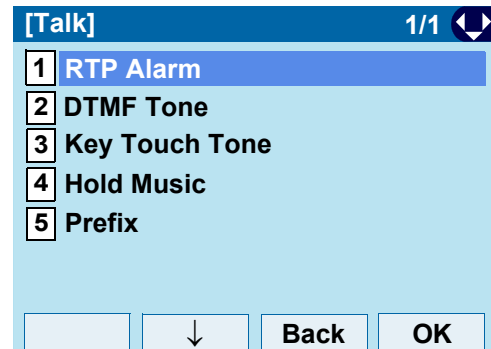

STEP 5: Select **0 Automatic**, **1 Disable** or **2 Enable** (see the following table).
Select an item by one of the following operations.

- Highlight an item by using , and press  or **OK**.
- Press **0** - **2**, and press  or **OK**.

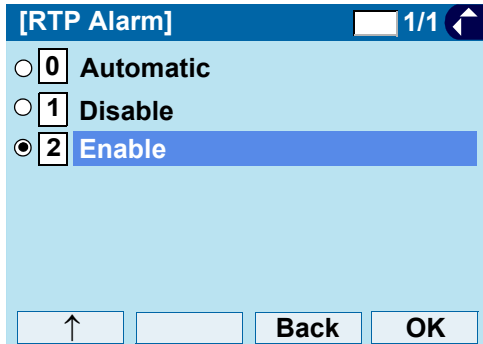

Menu Items	Description
0 Automatic	Follow the system settings. If no setting is made in the system, the default setting (Alarm=ON) is applied.
1 Disable	Follow the terminal settings (OFF).
2 Enable	Follow the terminal settings (ON).

TIP For the setting on the system, contact the System Administrator.

TIP Default setting is **Automatic**.

TIP The enabled item is highlighted.



• Enable/Disable DTMF Tone

The procedure below shows how to enable/disable DTMF Tone.

STEP 1: Display the **Menu** screen, select **Setting**.

STEP 2: Select **1 User Setting**.

Select an item by one of the following operations.

- Highlight an item by using , and press ,  or **OK**.
- Press **1**.

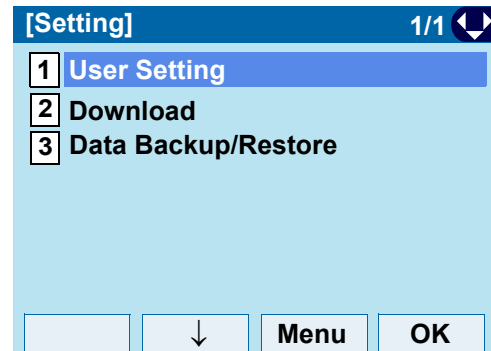

STEP 3: Select **2 Talk**.

Select an item by one of the following operations.

- Highlight an item by using , and press ,  or **OK**.
- Press **2**.

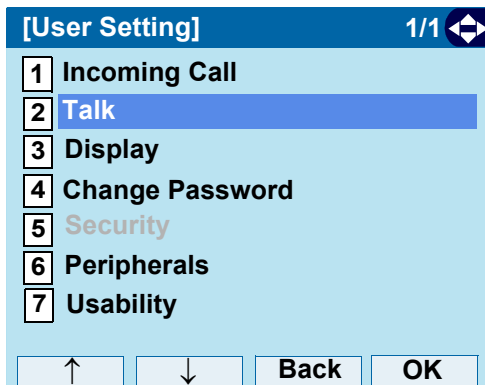

- STEP 4: Select **2 DTMF Tone**.
 Select an item by one of the following operations.
- Highlight an item by using , and press , or **OK**.
 - Press **2**.

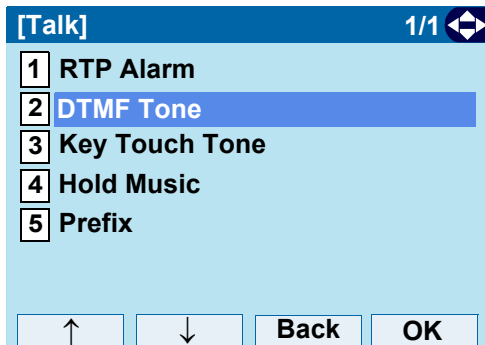

- STEP 5: Select **0 Automatic**, **1 Disable** or **2 Enable** (see the following table).
 Select an item by one of the following operations.
- Highlight an item by using , and press or **OK**.
 - Press **0** - **2**, and press or **OK**.

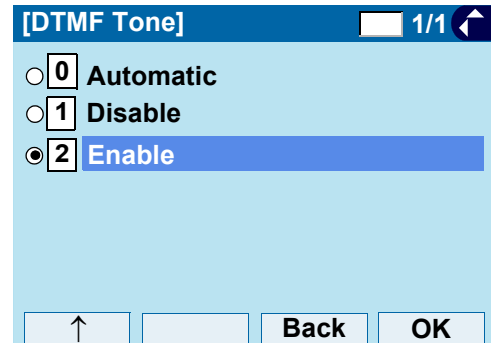

Menu Items	Description
0 Automatic	Follow the system settings. If no setting is made in the system, the default setting (DTMF=ON) is applied.
1 Disable	Follow the terminal settings (OFF).
2 Enable	Follow the terminal settings (ON).

- TIP** For the setting on the system, contact the System Administrator.
- TIP** Default setting is **Automatic**.
- TIP** The enabled item is highlighted.



• Set Key TouchTone

The procedure below shows how to set the Key Touch Tone. Key Touch Tone is a tone generated when the digit keys are pressed while DT730G is off-hook.

STEP 1: Display the **Menu** screen, select **Setting**.

STEP 2: Select **1 User Setting**.

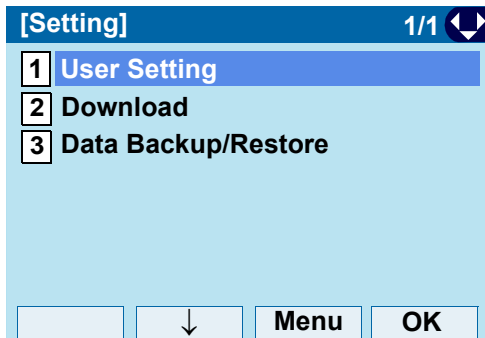

Select an item by one of the following operations.

- Highlight an item by using , and press ,  or **OK**.
- Press **1**.



STEP 3: Select **2 Talk**.

Select an item by one of the following operations.

- Highlight an item by using , and press ,  or **OK**.
- Press **2**.

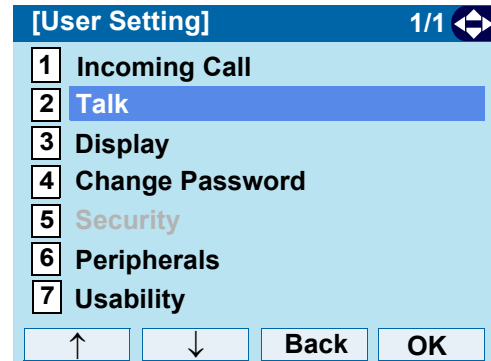

STEP 4: Select **3 Key Touch Tone**.

Select an item by one of the following operations.

- Highlight an item by using , and press ,  or **OK**.
- Press **3**.

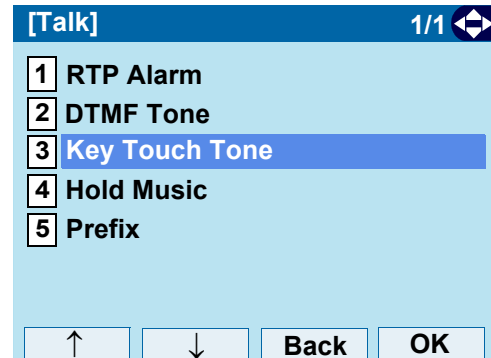

STEP 5: Select **0 Automatic**, **1 No Tone**, **2 Tone** or **3 Voice**.

Select an item by one of the following operations.

- Highlight an item by using , and press  or **OK**.
- Press **0** - **3**, and press  or **OK**.

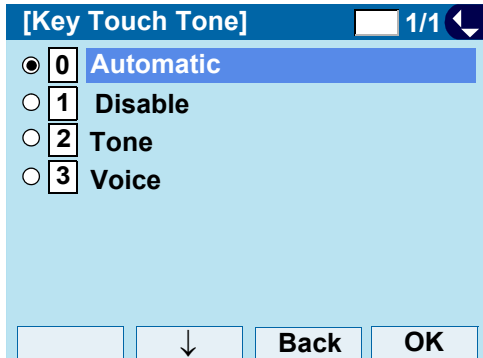

Note: When *Automatic* is set, the default setting (*Tone*) is applied.

TIP Default setting is **Automatic**.

TIP The enabled item is highlighted.



• Set Music on Hold

The procedure below shows how to set Music on Hold to be heard by DT730G user.

STEP 1: Display the **Menu** screen, select **Setting**.

STEP 2: Select **1 User Setting**.

Select an item by one of the following operations.

- Highlight an item by using , and press ,  or **OK**.
- Press **1**.

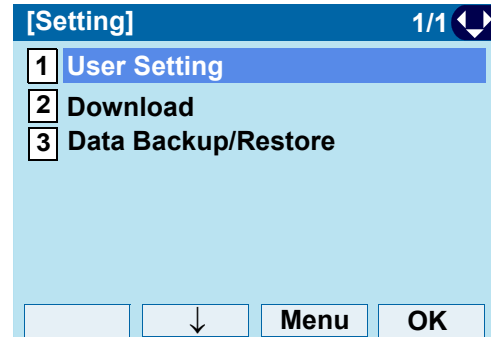

STEP 3: Select **2 Talk**.

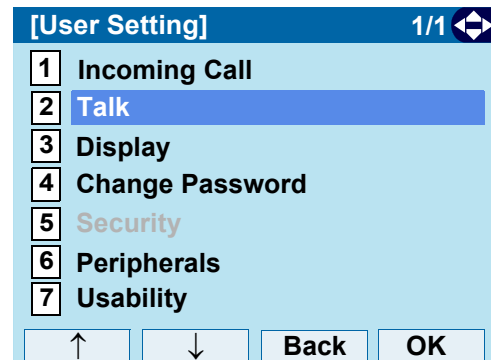

Select an item by one of the following operations.

- Highlight an item by using , and press ,  or **OK**.
- Press **2**.



STEP 4: Select **4 Hold Music**.

Select an item by one of the following operations.

- Highlight an item by using , and press ,  or **OK**.
- Press **4**.

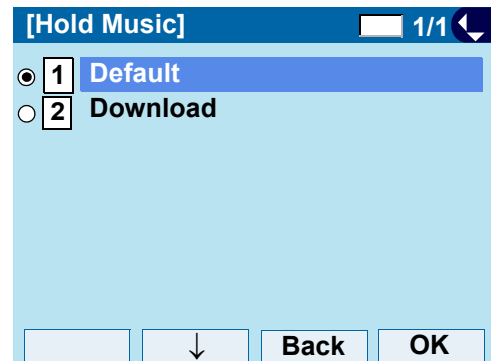



Note: You can preview the designated music on hold. When selecting *Download*, the music on hold file must be downloaded in advance. If there is no downloaded file, you hear no tone in the preview function (in actual operating conditions, “Minuet” is automatically applied.).

STEP 5: Select a desired Music on Hold. You can preview the designated Music on Hold.

Choose **1 Default** when the default data (Minuet) is used as Music on Hold. Choose **2 Download** when a downloaded data is used as Music on Hold.

Select an item by one of the following operations.

- Highlight an item by using , and press  or **OK**.
- Press **1** or **2**, and press  or **OK**.

TIP Default setting is **Default** (Minuet).

TIP The enabled item is highlighted.

• Set Clock Format



Determines whether the time is displayed using a 12-hour or 24-hour clock format.

Note: *This setting is available for Time Display only. Call Log feature displays the time in 24-hour format regardless of this setting.*

STEP 1: Display the **Menu** screen, select **Setting**.

STEP 2: Select **1 User Setting**.

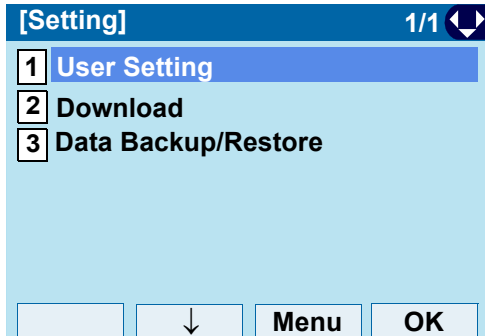

Select an item by one of the following operations.

- Highlight an item by using , and press ,  or **OK**.
- Press **1**.



STEP 3: Select **3 Display**.

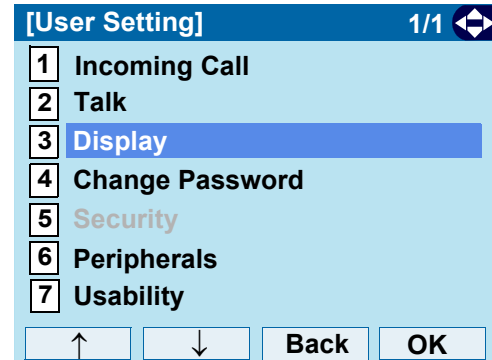

Select an item by one of the following operations.

- Highlight an item by using , and press ,  or **OK**.
- Press **3**.



STEP 4: Select **1 Time Format**.

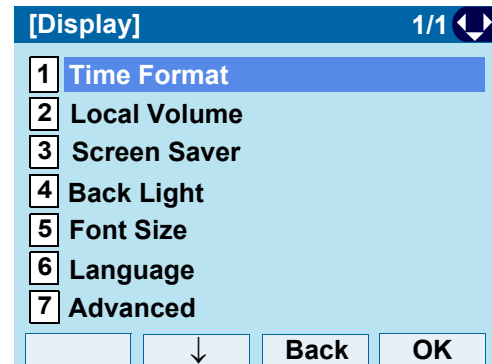

Select an item by one of the following operations.

- Highlight an item by using , and press ,  or **OK**.
- Press **1**.



STEP 5: Make a selection from the following list.

Select an item by one of the following operations.

- Highlight an item by using , and press  or **OK**.
- Press **0** - **2**, and press  or **OK**.

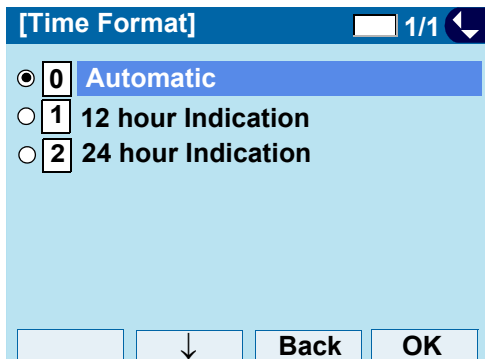

Menu Items	Description
0 Automatic	Follow the system settings.
1 12-hour indication	12-hour clock
2 24-hour indication	24-hour clock

Note: When selecting *Automatic* or not performing this time format setting, **12-hour clock** is automatically applied.

TIP For the setting on the system, contact the System Administrator.

TIP Default setting is **Automatic**.

TIP The enabled item is highlighted.



• Enable/Disable Volume Level Display

Determines whether or not to display the following volume levels: handset receiver volume, speaker volume, ringer tone volume and LCD contrast.

STEP 1: Display the **Menu** screen, select **Setting**.

STEP 2: Select **1 User Setting**.

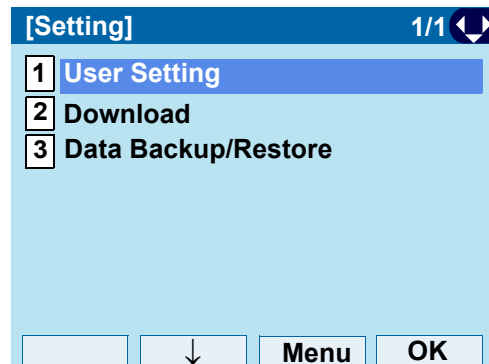

Select an item by one of the following operations.

- Highlight an item by using , and press ,  or **OK**.
- Press **1**.



STEP 3: Select **3 Display**.

Select an item by one of the following operations.

- Highlight an item by using , and press ,  or **OK**.
- Press **3**.

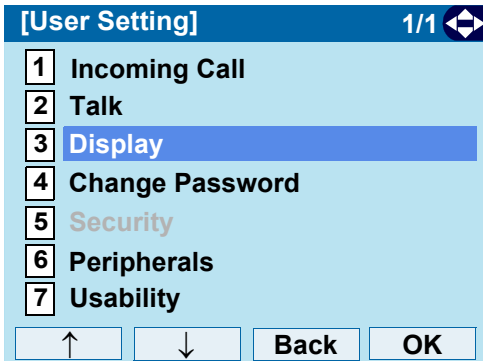

- STEP 4: Select **2 Local Volume**.
 Select an item by one of the following operations.
- Highlight an item by using , and press , or **OK**.
 - Press **2**.

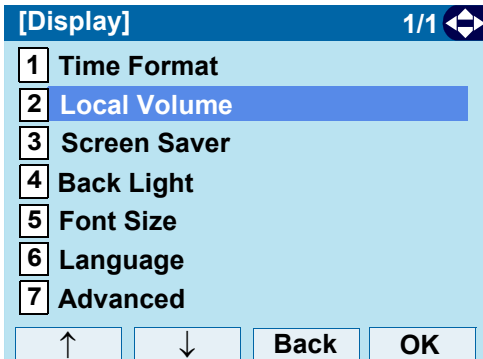

- STEP 5: Make a selection from the following list.
 Select an item by one of the following operations.
- Highlight an item by using , and press or **OK**.
 - Press **0** - **2**, and press or **OK**.

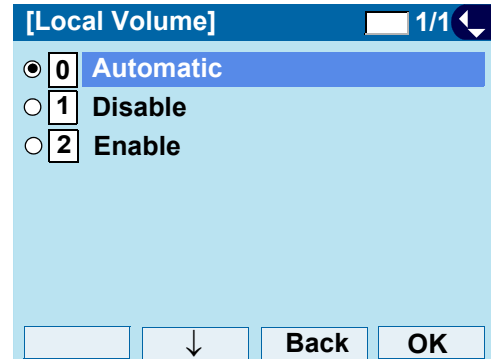

Menu Items	Description
0 Automatic	Each volume level is displayed on LCD.
1 Disable	Each volume level is not displayed on LCD.
2 Enable	Each volume level is displayed on LCD.

Note: When **0 Automatic** is set, the default setting (Enable) is applied.

- TIP** Default setting is **Automatic**.
- TIP** The enabled item is highlighted.

• Set Screen Saver



Screen Saver works after the telephone is idle for a certain period of time. The Screen Saver will be displayed from XML server when the XML server is available. If the Screen Saver cannot be downloaded from the XML server, the default Screen Saver will be displayed.

Note: For details on the XML service, contact the System Administrator.

STEP 1: Display the **Menu** screen, select **Setting**.

STEP 2: Select **1 User Setting**.

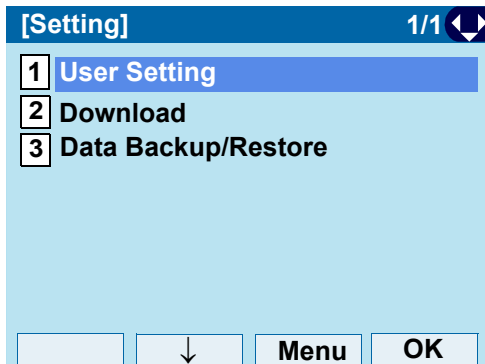

Select an item by one of the following operations.

- Highlight an item by using , and press ,  or **OK**.
- Press **1**.



STEP 3: Select **3 Display**.

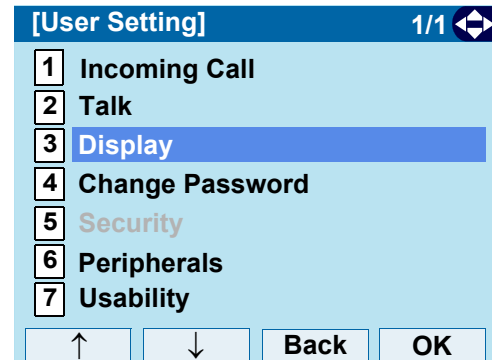

Select an item by one of the following operations.

- Highlight an item by using , and press ,  or **OK**.
- Press **3**.



STEP 4: Select **3 Screen Saver**.

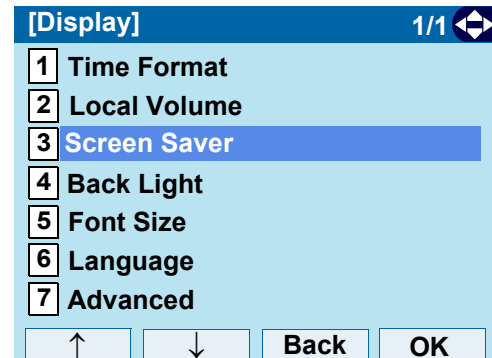

Select an item by one of the following operations.

- Highlight an item by using , and press ,  or **OK**.
- Press **3**.



STEP 5: Choose **1** **Screen Saver Mode**.

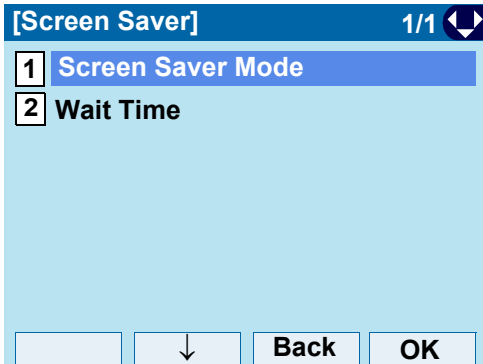

Select an item by one of the following operations.

- Highlight an item by using , and press ,  or **OK**.
- Press **1**.



STEP 6: Choose either **1** **Disable** or **2** **Enable**.

Select an item by one of the following operations.

- Highlight an item by using , and press  or **OK**.
- Press **1** or **2**, and press  or **OK**.

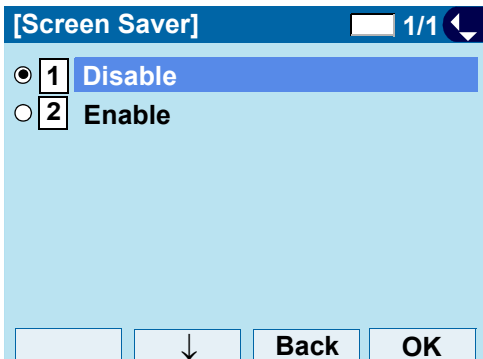

TIP Default setting is **Disable**.

TIP The enabled item is highlighted.

STEP 7: The display returns to the Screen Saver screen. When **2** **Enable** is selected, on Step 7 Select **2** **Wait Time**.

Input **Wait Time** to launch the screen saver (1-999 min) and press  or **OK**.

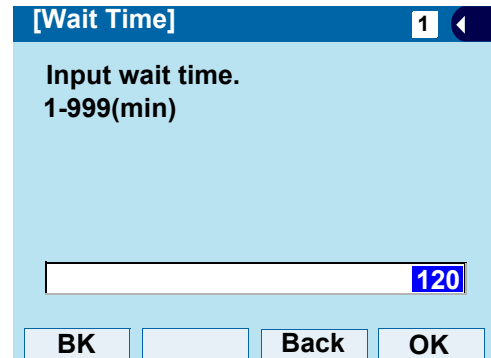

TIP Default value is 120 min.



• Set Brightness of Backlight

The following steps show how to set the brightness level of the LCD backlight.

STEP 1: Display the **Menu** screen, select **Setting**.

STEP 2: Select **1 User Setting**.

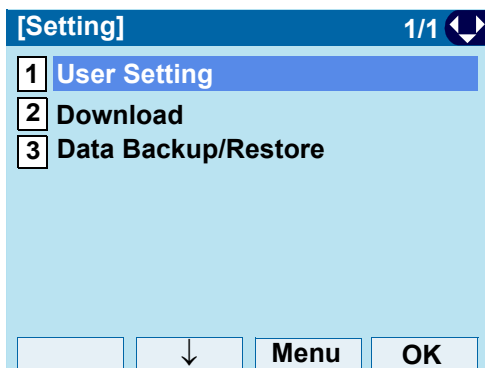

Select an item by one of the following operations.

- Highlight an item by using , and press ,  or **OK**.
- Press **1**.



STEP 3: Select **3 Display**.

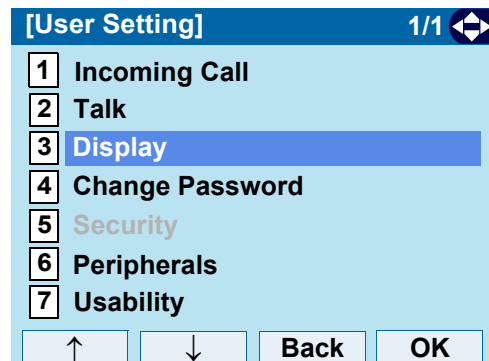

Select an item by one of the following operations.

- Highlight an item by using , and press ,  or **OK**.
- Press **3**.





STEP 4: Select **4 Back Light**.

Select an item by one of the following operations.

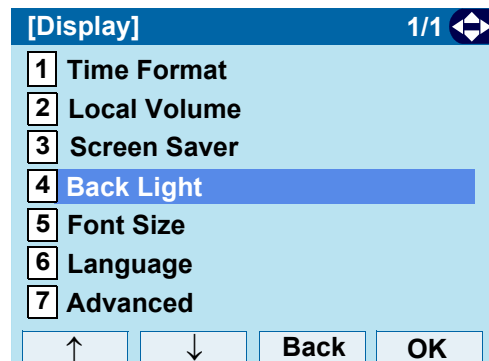
- Highlight an item by using , and press ,  or **OK**.
- Press **4**.



STEP 5: Select a desired brightness level.
Select an item by one of the following operations.

- Highlight an item by using , and press  or **OK**.
- Press **1** - **4**, and press  or **OK**.

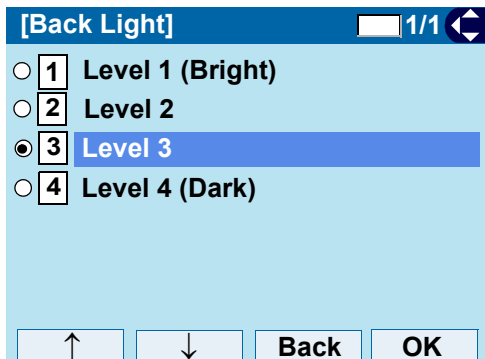

TIP Default setting is **Level 3**.

TIP The enabled item is highlighted.



• Change Character Size

The following steps show how to change the displayed character size on the LCD.

STEP 1: Display the **Menu** screen, select **Setting**.

STEP 2: Select **1 User Setting**.

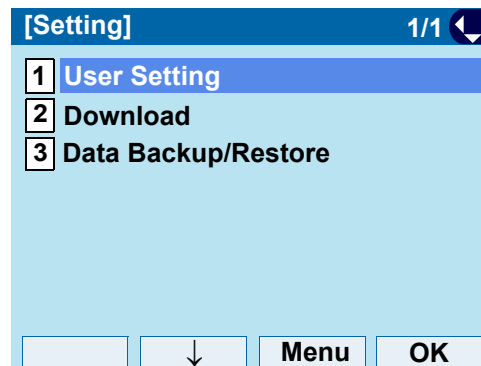

Select an item by one of the following operations.

- Highlight an item by using , and press ,  or **OK**.
- Press **1**.



STEP 3: Select **3 Display**.

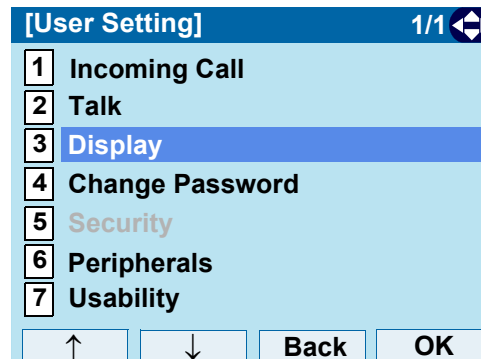

Select an item by one of the following operations.

- Highlight an item by using , and press ,  or **OK**.
- Press **3**.



STEP 4: Select **5** **Font Size**.

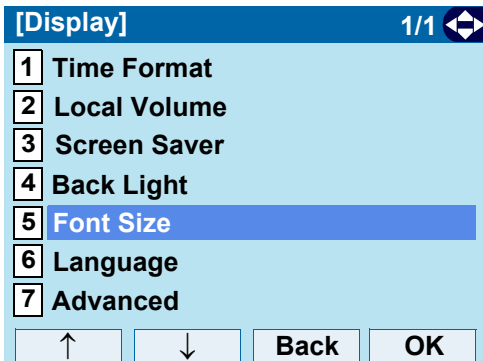

Select an item by one of the following operations.

- Highlight an item by using , and press , or **OK**.
- Press **5**.



STEP 5: Choose either **Standard** or **Small**.

Select an item by one of the following operations.

- Highlight an item by using , and press , or **OK**.
- Press **1** or **2**, and press  or **OK**.

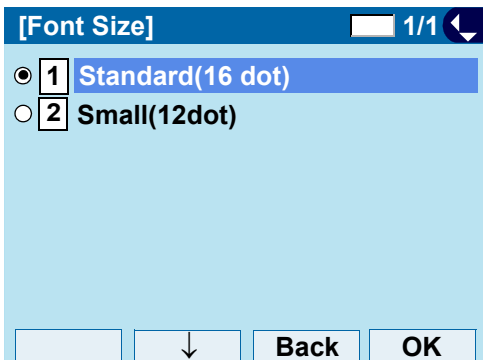

TIP Default setting is **Standard**.

TIP The enabled item is highlighted.



• **Set a Language**

The following explains how to set a language to be displayed on LCD.

STEP 1: Display the **Menu** screen, select **Setting**.

STEP 2: Select **1** **User Setting**.

Select an item by one of the following operations.

- Highlight an item by using , and press , or **OK**.
- Press **1**.

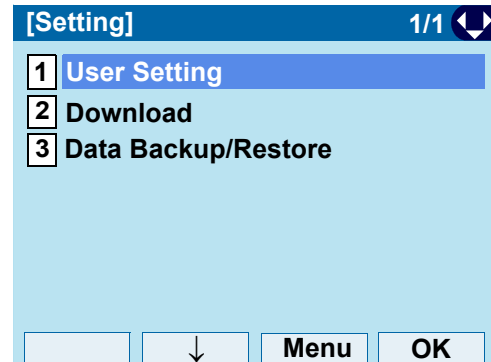

STEP 3: Select **3** **Display**.

Select an item by one of the following operations.

- Highlight an item by using , and press , or **OK**.
- Press **3**.

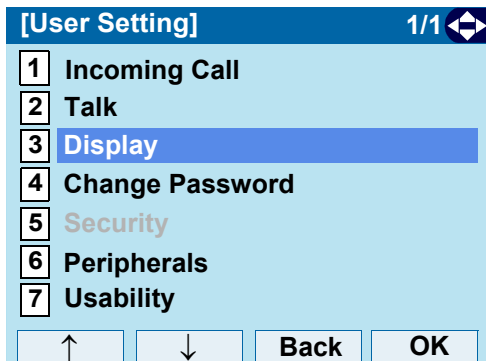

- STEP 4: Select **6** Language.
 Select an item by one of the following operations.
- Highlight an item by using , and press , or **OK**.
 - Press **6**.

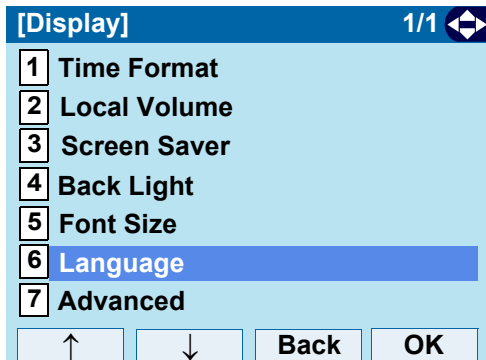

- STEP 5: Select a desired language.
 Select an item by one of the following operations.
- Highlight an item by using , and press or **OK**.
 - Press the digit key of desired number, and press or **OK**.
- For example, press **1** + **5** to select **15** Spanish.

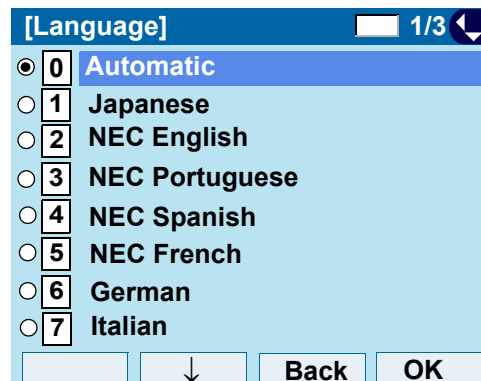

- TIP** Default setting is **Automatic**.
- TIP** When selecting **Automatic**, follow the setting on the System. For the setting on the System, contact to the System Administrator.
- TIP** The enabled item is highlighted.

• Set Wallpaper



The following explains how to set wallpaper.

Note: *ITL-12DG-3 does not support the wallpaper setting.*

STEP 1: Display the **Menu** screen, select **Setting**.

STEP 2: Select **1 User Setting**.

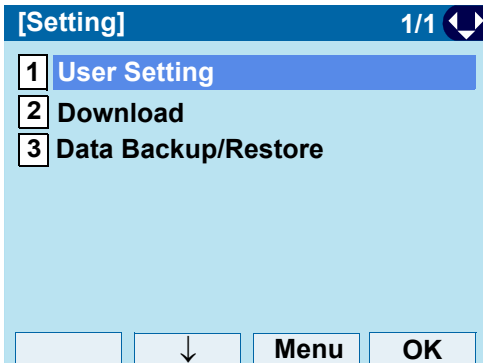

Select an item by one of the following operations.

- Highlight an item by using , and press ,  or **OK**.
- Press **1**.



STEP 3: Select **3 Display**.

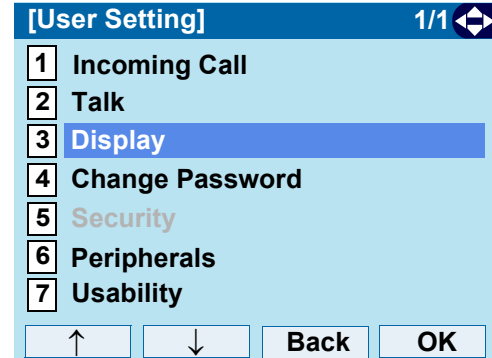

Select an item by one of the following operations.

- Highlight an item by using , and press ,  or **OK**.
- Press **3**.



STEP 4: Select **7 Advanced**.

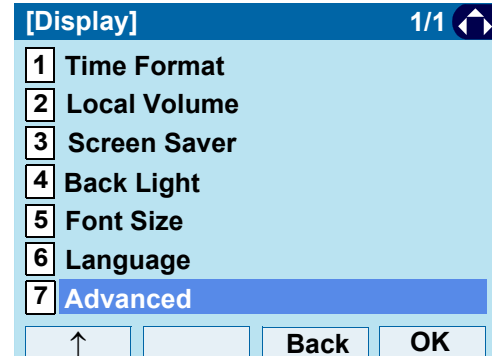

Select an item by one of the following operations.

- Highlight an item by using , and press ,  or **OK**.
- Press **7**.



STEP 5: Select **1 Wallpaper**.





Select an item by one of the following operations.

- Highlight an item by using , and press ,  or **OK**.
- Press **1**.



STEP 6: Choose either **1 Default** or **2 Download**.

Select an item by one of the following operations.

- Highlight an item by using , and press ,  or **OK**.
- Press **1** or **2**, and press  or **OK**.

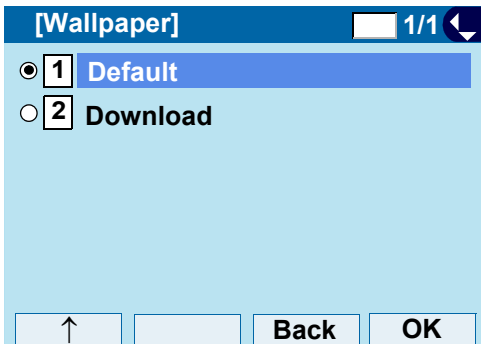

Note: When choosing **Download**, the wallpaper file must be downloaded in advance. If there is no downloaded file, the wallpaper is default.

TIP Default setting is **Default**.

TIP The enabled item is highlighted.

• **Set Character Font Color**

The following steps show how to set the displayed character color on the LCD.



Note: Font characters are displayed in LCD 4-line display area.

Note: ITL-12DG-3 does not support Font Color setting.

STEP 1: Display the **Menu** screen, select **Setting**.

STEP 2: Select **1 User Setting**.

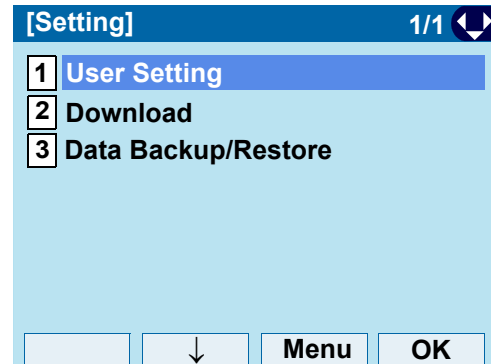

Select an item by one of the following operations.

- Highlight an item by using , and press ,  or **OK**.
- Press **1**.



STEP 3: Select **3 Display**.

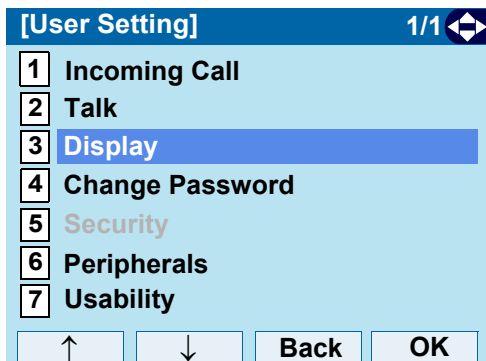

Select an item by one of the following operations.

- Highlight an item by using , and press ,  or **OK**.
- Press **3**.



STEP 5: Select **3 Font Color**.

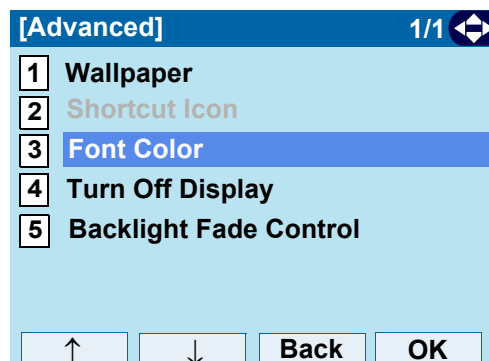

Select an item by one of the following operations.

- Highlight an item by using , and press ,  or **OK**.
- Press **3**.



STEP 4: Select **7 Advanced**.

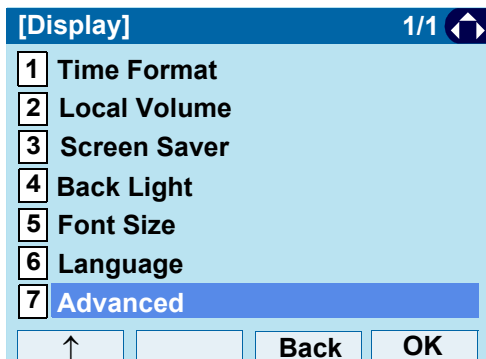

Select an item by one of the following operations.

- Highlight an item by using , and press ,  or **OK**.
- Press **7**.



STEP 6: Select a desired color.

Select an item by one of the following operations.

- Highlight an item by using , and press  or **OK**.
- Press the digit key of desired number, and press  or **OK**.

For example, press **1** + **5** to select **15 Color 15**.

Table of Font Color

[Font Color] 1/2

- 1 Color 1
- 2 Color 2
- 3 Color 3
- 4 Color 4
- 5 Color 5
- 6 Color 6
- 7 Color 7
- 8 Color 8

↑ ↓ Back OK

[Font Color] 2/2

- 9 Color 9
- 10 Color 10
- 11 Color 11
- 12 Color 12
- 13 Color 13
- 14 Color 14
- 15 Color 15
- 16 Color 16

↓ Back OK

NO. §	Color Name §	RGB code §
1 §	Color 1 §	0x000000 §
2 §	Color 2 §	0x000080 §
3 §	Color 3 §	0x0000FF §
4 §	Color 4 §	0x008000 §
5 §	Color 5 §	0x008080 §
6 §	Color 6 §	0x00FF00 §
7 §	Color 7 §	0x00FFFF §
8 §	Color 8 §	0x800000 §
9 §	Color 9 §	0x800080 §
10 §	Color 10 §	0x808000 §
11 §	Color 11 §	0xA0A0A0 §
12 §	Color 12 §	0xC0C0C0 §
13 §	Color 13 §	0xFF0000 §
14 §	Color 14 §	0xFF00FF §
15 §	Color 15 §	0xFFFF00 §
16 §	Color 16 §	0xFFFFFFFF §

TIP

The color of the character corresponds to an actual display color on the screen of the color selection.

TIP

Default setting is **Color 2**.

TIP

The enabled item is highlighted.



• Set Turn Off Display

The Turn off Display works after the telephone is idle for a certain period of time. The following shows how to set Turn off Display.

STEP 1: Display the **Menu** screen, select **Setting**.

STEP 2: Select **1 User Setting**.

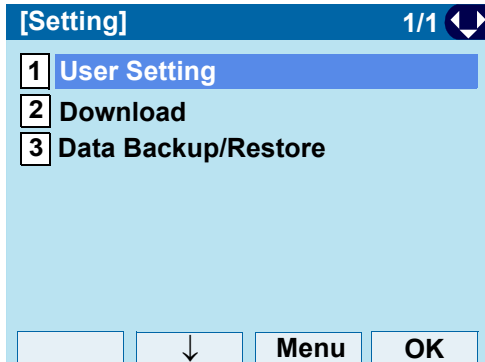

Select an item by one of the following operations.

- Highlight an item by using , and press ,  or **OK**.
- Press **1**.



STEP 3: Select **3 Display**.

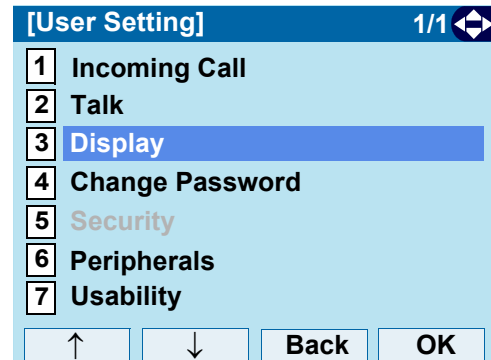

Select an item by one of the following operations.

- Highlight an item by using , and press ,  or **OK**.
- Press **3**.





STEP 4: Select **7 Advanced**.

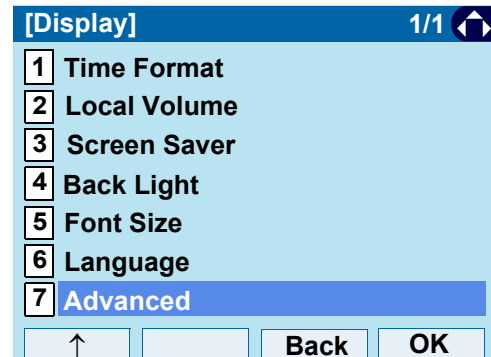

Select an item by one of the following operations.

- Highlight an item by using , and press ,  or **OK**.
- Press **7**.



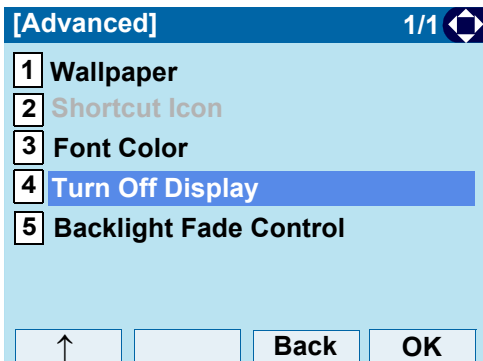

- STEP 5: Select **4 Turn Off Display**.
Select an item by one of the following operations.
- Highlight an item by using , and press ,  or **OK**.
 - Press **4**.

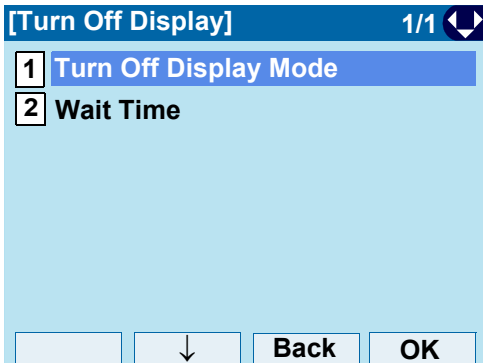

- STEP 6: Choose **1 Turn Off Display Mode**.
Select an item by one of the following operations.
- Highlight an item by using , and press ,  or **OK**.
 - Press **1**.



- STEP 7: Select **1 Disable**, **2 Enable** or **3 App priority**.
Select an item by one of the following operations.
- Highlight an item by using , and press  or **OK**.
 - Press **1**, **2** or **3**, and press  or **OK**.

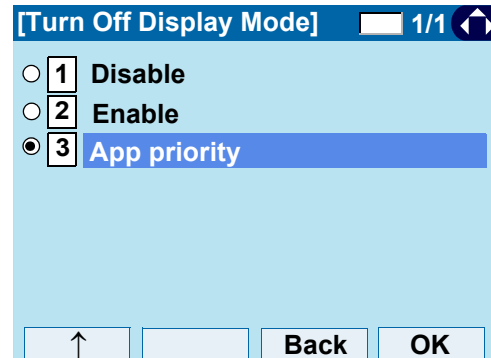



Note: You can set a screen saver to an external application. For details, contact the System Administrator.

TIP If you select **App priority**, the screen saver is set to an external application. When the external application orders the terminal display to turn off while the screen saver activates, the display will be turned off.

TIP The enabled item is highlighted.

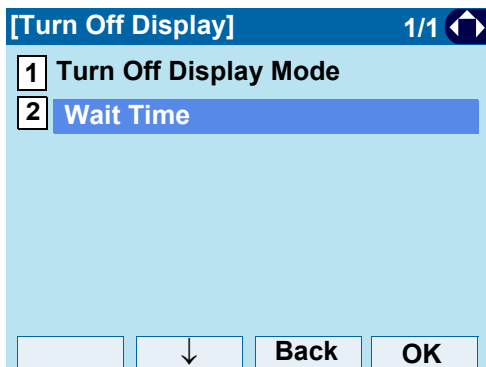
- STEP 8: The display returns to the Turn Off Display screen. When **2 Enable** is selected at Step 7, Choose **2 Wait Time**.



STEP 9: Input **Wait Time** to turn off the display (1-999 min) and press  or **OK**.

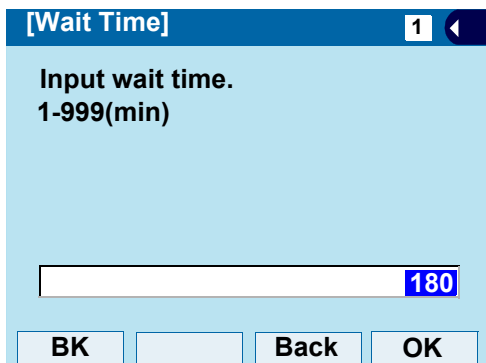

TIP

When **App priority** is selected for **Turn Off Display Mode**, if the external application does not give instructions to turn off the display, the setting of **Wait Time** will be invalid.

TIP

Default value is **180 min**.



• Set Backlight Fade Control

The following explains how to set Backlight Fade Control. When you set Backlight Fade Control as **Enable**, you can turn on/off the LCD smoothly.

STEP 1: Display the **Menu** screen, select **Setting**.

STEP 2: Select **1 User Setting**.

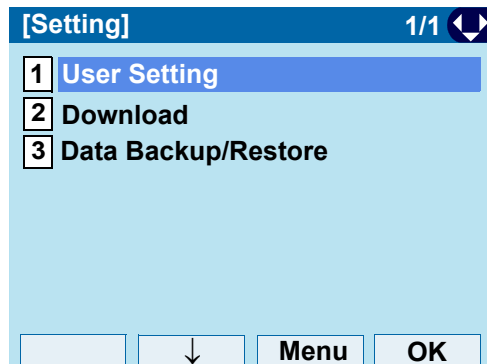

Select an item by one of the following operations.

- Highlight an item by using , and press ,  or **OK**.
- Press **1**.





STEP 3: Select **3 Display**.

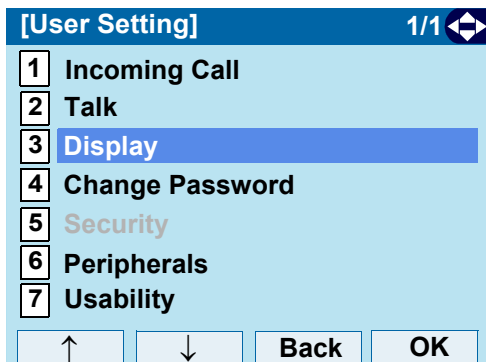

Select an item by one of the following operations.

- Highlight an item by using , and press ,  or **OK**.
- Press **3**.



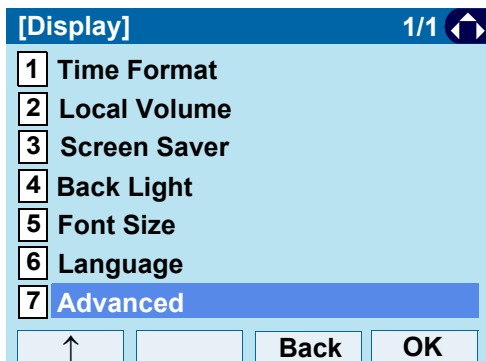

- STEP 4: Select **7 Advanced**.
 Select an item by one of the following operations.
- Highlight an item by using , and press ,  or **OK**.
 - Press **7**.

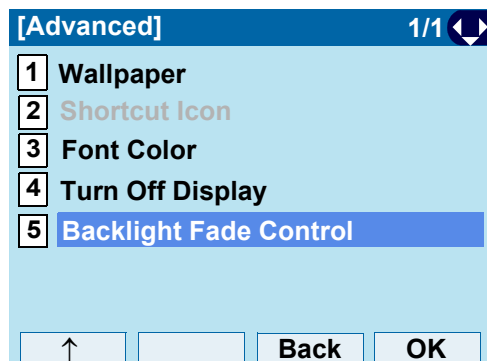

- STEP 5: Select **5 Backlight Fade Control**.
 Select an item by one of the following operations.
- Highlight an item by using , and press ,  or **OK**.
 - Press **5**.



- STEP 6: Choose either **1 Disable** or **2 Enable**.
 Select an item by one of the following operations.
- Highlight an item by using , and press  or **OK**.
 - Press **1** or **2**, and press  or **OK**.

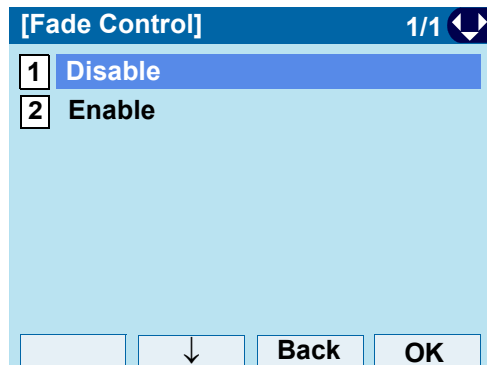

TIP | Default value is **Enable**.

• Change Password



To change an existing password, follow the procedure below. This password is used for the following occasions.

- To lock/unlock the telephone.
- To delete the directory data.
- To reset the telephone settings.

STEP 1: Display the **Menu** screen, select **Setting**.

STEP 2: Select **1 User Setting**.

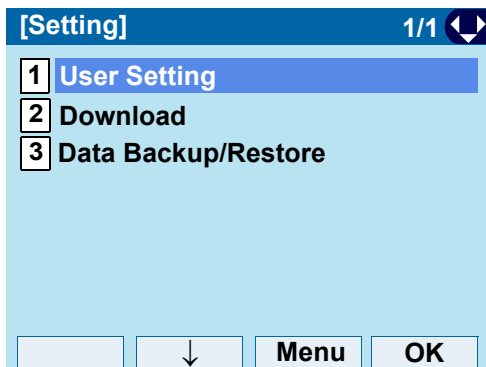

Select an item by one of the following operations.

- Highlight an item by using , and press , or **OK**.
- Press **1**.



STEP 3: Select **4 Change Password**.

Select an item by one of the following operations.

- Highlight an item by using , and press , or **OK**.
- Press **4**.

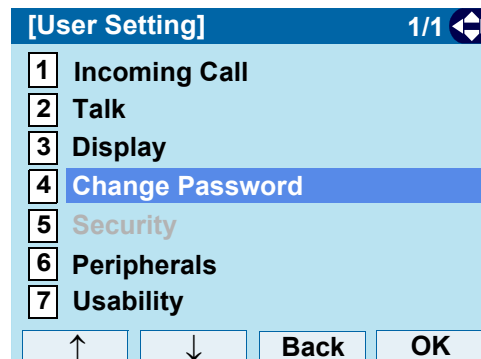

STEP 4: Enter the old password.

After entering the old password, press  or **Set**.

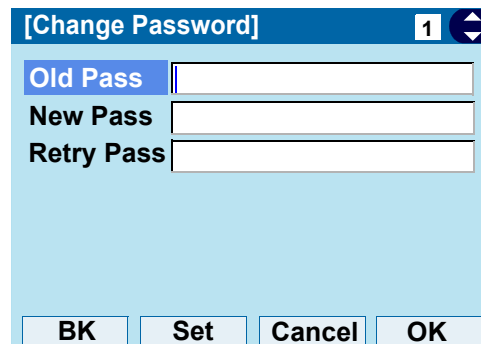

Note: The default password is **0000**. When changing the password for the first time, enter **0000** as the old password.

STEP 5: Enter the new password.
After entering the new password, press  or **Set**.

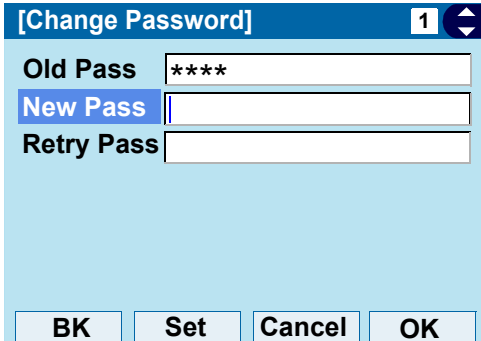

STEP 6: Enter the new password again.
After entering the retry password, press  or **OK**.

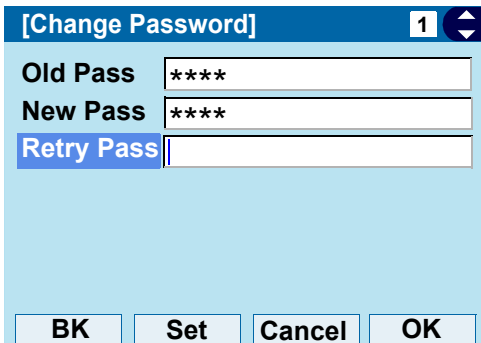

Note: A maximum of 32 digits (0-9, * and #) can be used when setting a new password.

STEP 7: When the password entry completes successfully, the display changes as follows.

Press  or **OK**.

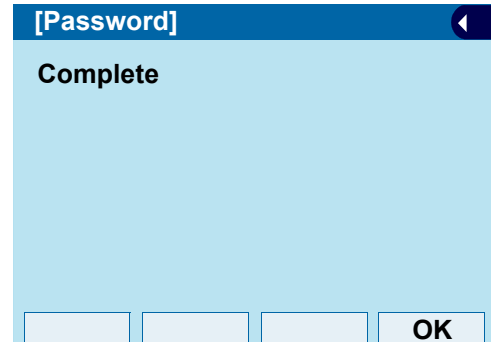

TIP

When the password entry ends in failure, the following error message is issued. In that case, press **OK** and make a retry.

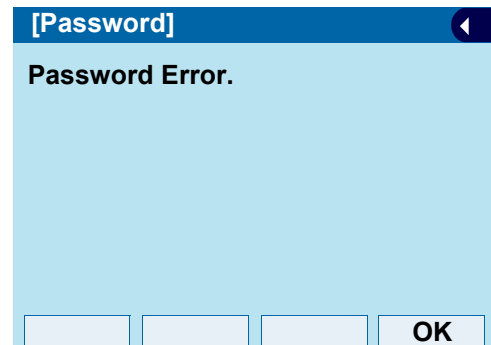

• Safely Remove USB Device

The following explains how to remove a connected USB device from the terminal.

Note: Be sure to remove the USB device when the terminal is connected to the system.

Note: Ensure any connected USB device is removed before powering off the terminal. This may cause failure of the USB device.

TIP

When overcurrent of the USB device is detected, power supply to the USB port will be suspended. To restart the USB device power supply, remove the USB device and reboot the terminal.

TIP

When using Power Hub (When AC adapter is not used), plug and unplug the LAN cable connected to the terminal.



TIP

When using AC adapter, plug and unplug the AC adapter after disconnecting the LAN cable connected to the terminal. Also, when you connecting/disconnecting the LAN cable, be sure not to confuse the cable for LAN port with the cable for PC port.

STEP 1: Display the **Menu** screen, select **Setting**.

STEP 2: Select **1 User Setting**.

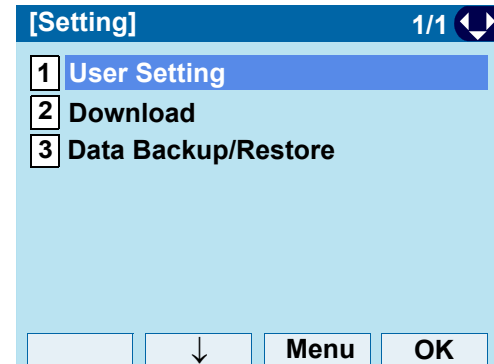

Select an item by one of the following operations.

- Highlight an item by using , and press ,  or **OK**.
- Press **1**.





STEP 3: Select **6 Peripherals**.

Select an item by one of the following operations.

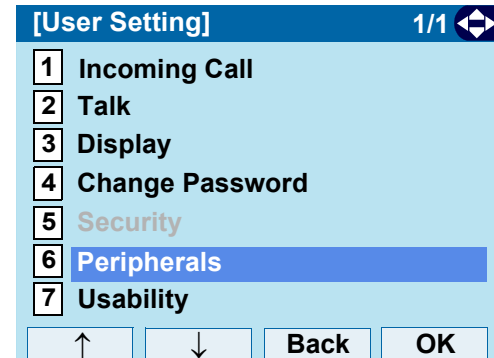
- Highlight an item by using , and press ,  or **OK**.
- Press **6**.



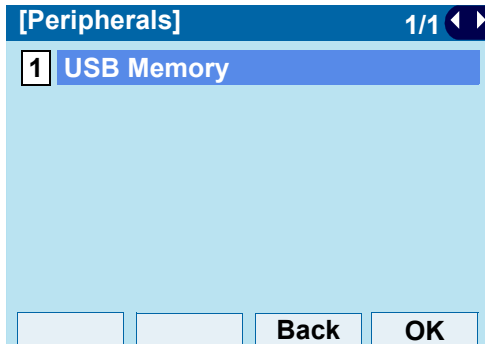

STEP 4: Ensure **1** **USB Memory** is specified.
Select an item by one of the following operations.

- Highlight an item by using, press ,  or **OK**.
- Press **1**.



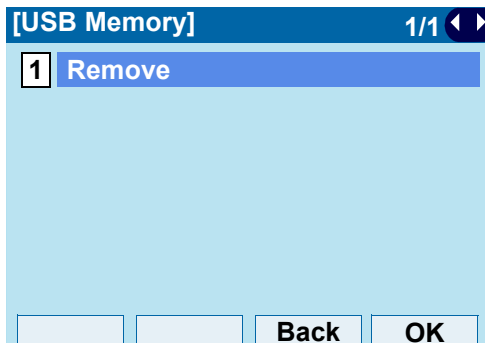

STEP 5: Ensure **1** **Remove** is specified.
Select an item by one of the following operations.

- Highlight an item by using, press ,  or **OK**.
- Press **1**.

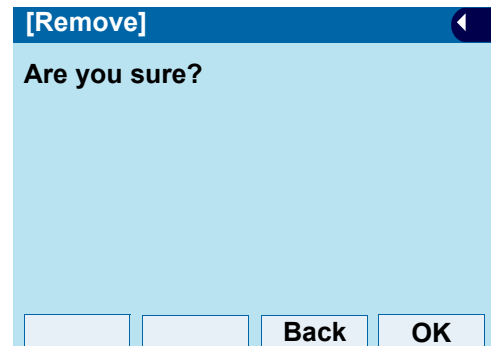

STEP 6: Press  or **OK**.



STEP 7: When **Remove complete!** is displayed,
Press  or **OK**, and remove the USB
device from the terminal.

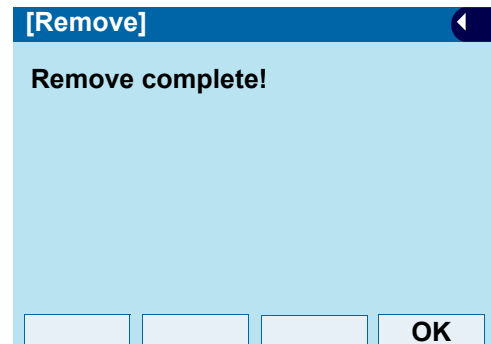

Note: *If the USB device is not removed successfully, **Remove failure!** appears. Press  or **OK**, and restart the procedure from [STEP 6](#) above.*



• Set Usability

The procedure below shows how to set the operation of Help key while pop-up window is displayed.

STEP 1: Display the **Menu** screen, select **Setting**.

STEP 2: Select **1 User Setting**.

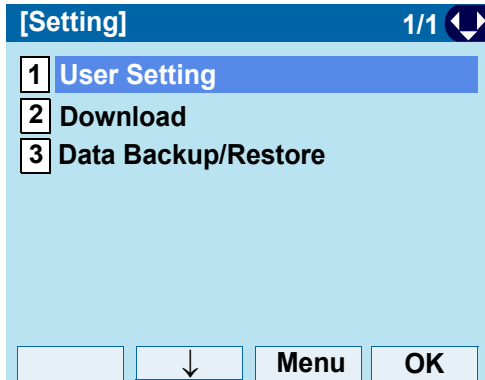

Select an item by one of the following operations.

- Highlight an item by using , and press ,  or **OK**.
- Press **1**.



STEP 3: Select **7 Usability**.

Select an item by one of the following operations.

- Highlight an item by using , and press ,  or **OK**.
- Press **7**.

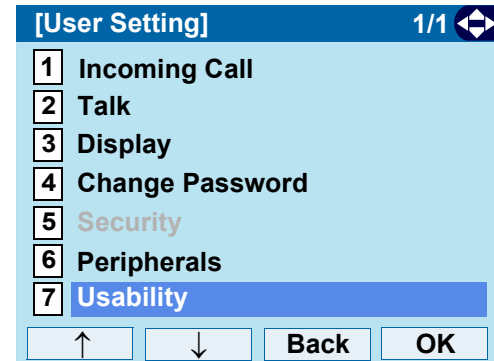



STEP 4: Ensure **1 Help Key Mode** is specified.

Select an item by one of the following operations.

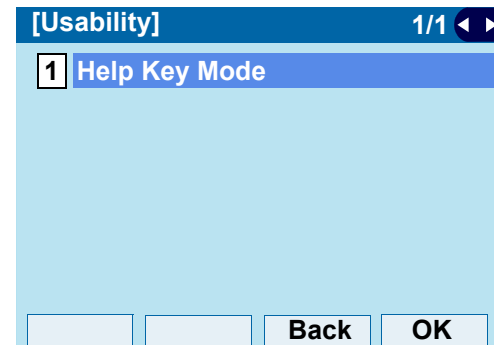
- Press  or **OK**.
- Press **1**.



STEP 5: Choose the desired **Help** key mode.
Select an item by one of the following operations.

- Highlight an item by using , and press  or **OK**.
- Press **1** or **2**, and press  or **OK**.

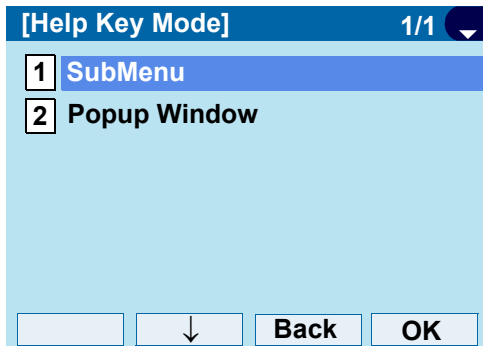

No.	Item	Description
1	SubMenu	Set the Help key which displays submenu.
2	Pop-up Window	Set the Help key which displays pop-up window.



• Reset Telephone Settings

The following explains how to clear personal data off the telephone.

STEP 1: Display the **Menu** screen, select **Setting**.

STEP 2: Select **1 User Setting**.

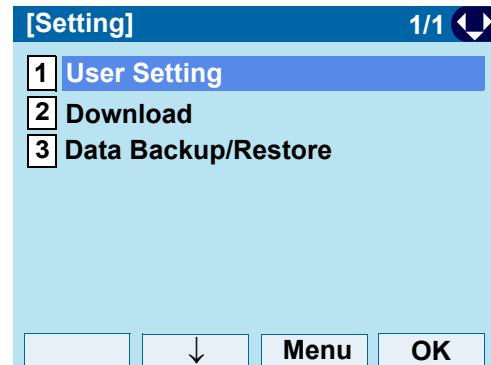

Select an item by one of the following operations.

- Highlight an item by using , and press ,  or **OK**.
- Press **1**.



STEP 3: Select **0 Setting Reset**.

Select an item by one of the following operations.

- Highlight an item by using , and press ,  or **OK**.
- Press **0**.

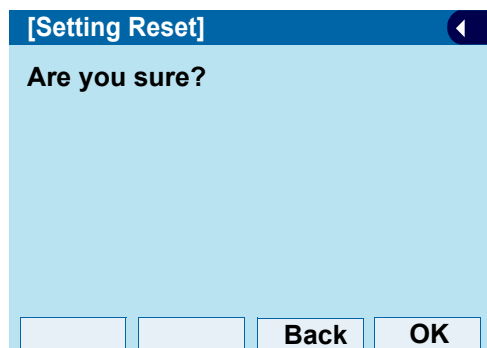
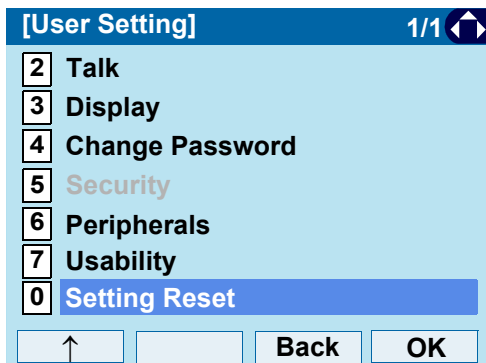

STEP 4: Enter the password.
After entering the password, press  or **OK**.

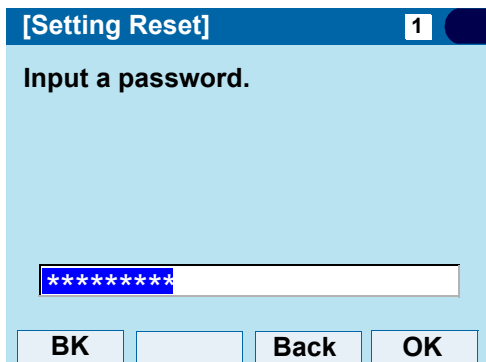

TIP When the password entry ends in failure, the following error message is issued. In that case, press **OK** and make a retry.

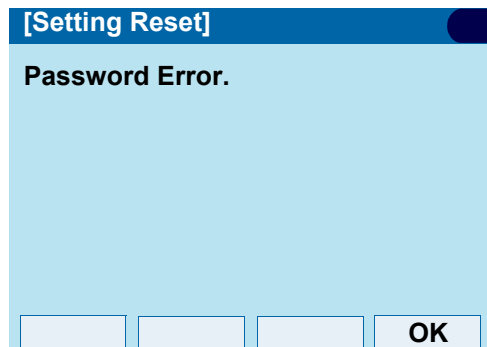

STEP 5: When the password entry completes successfully, the display changes as follows.
Press  or **OK** to clear the personal data off the telephone.

• Download a File

You can download files for Music on Hold, Ringer Tone, Directory and Wallpaper.

When downloading these files, the DT730G needs to be connected to the network that has FTP (TFTP server).

Note: For details on the FTP/TFTP service, contact the System Administrator.

Before starting the download, the IP Address of the FTP/TFTP Server must be entered from DT730G.

STEP 1: Set up the FTP/TFTP server.

<FTP server>

Put the downloading file into the designated directory (for Windows IIS, the default is "C:\InetPub\ftproot") of the FTP server.



<TFTP server>

Put the downloading file into a desired directory of TFTP server and specify it as the directory for downloading.

STEP 2: Display the **Menu** screen, select **Setting**.

STEP 3: Select **2 Download**.

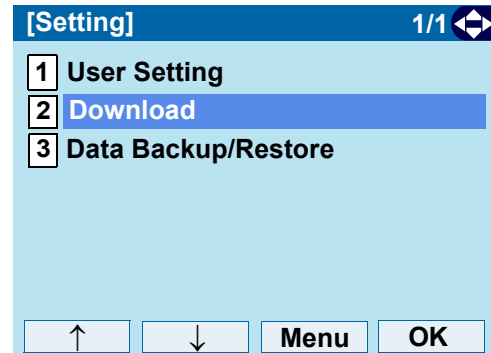

Select an item by one of the following operations.

- Highlight an item by using , and press ,  or **OK**.
- Press **2**.



STEP 4: Select **3 Protocol**.

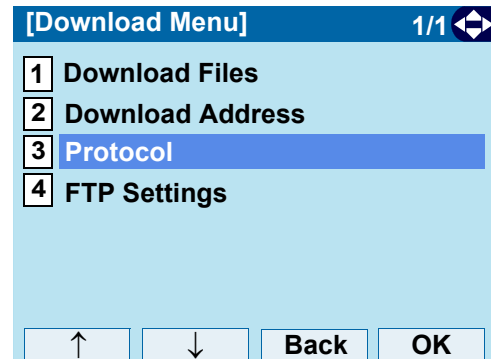

Select an item by one of the following operations.

- Highlight an item by using , and press ,  or **OK**.
- Press **3**.



STEP 5: Choose a protocol used by the server which stores the download file.

Select an item by one of the following operations.

- Highlight an item by using , and press  or **OK**.
- Press **1** or **2**, and press  or **OK**.

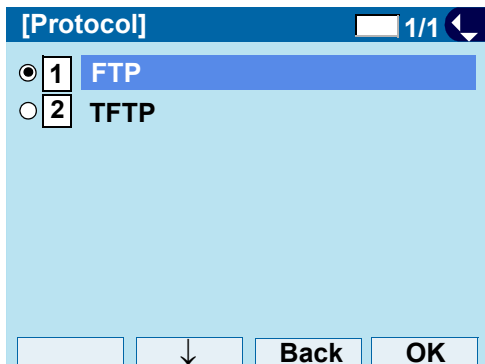



STEP 6: The display returns to the **Download Menu** screen.

If **1 FTP** is selected here, continue with STEP 7.

If **2 TFTP** is selected here, proceed to [STEP 15](#).

STEP 7: Select **4 FTP Settings**.

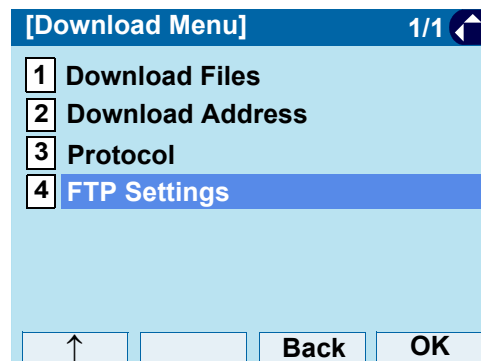

Select an item by one of the following operations.

- Highlight an item by using , and press  or **OK**.
- Press **4**.



STEP 8: Select **1 User ID**.

Select an item by one of the following operations.

- Highlight an item by using , and press ,  or **OK**.
- Press **1**.

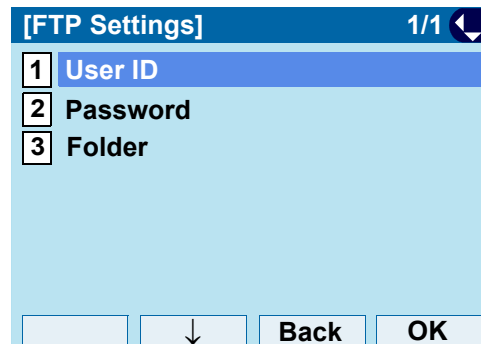

STEP 9: Enter a **User ID**.

Enter a User ID by pressing digit keys, and press  or **OK**.

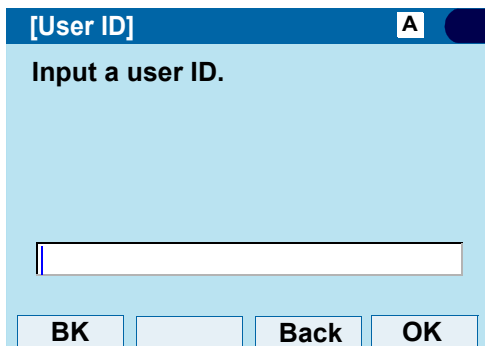



TIP

For details on character entry method, see [How to Input Characters](#).

STEP 10: The display returns to the **FTP Settings** screen. Select **2 Password**.

Select an item by one of the following operations.

- Highlight an item by using , and press ,  or **OK**.
- Press **2**.

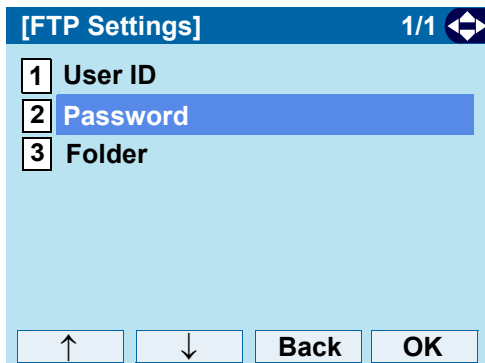

STEP 11: Enter a password.

Enter a User ID by pressing digit keys, and press  or **OK**.

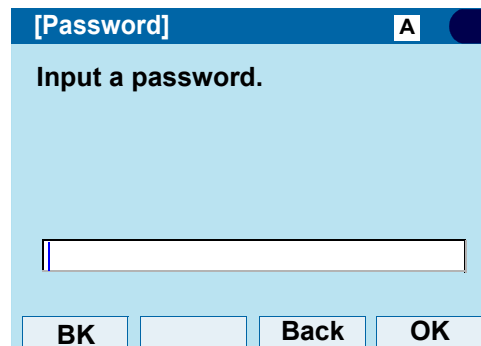



TIP

For details on character entry method, see [How to Input Characters](#).

STEP 12: The display returns to the **FTP Settings** screen. Select **3 Folder**.

Select an item by one of the following operations.

- Highlight an item by using , and press ,  or **OK**.
- Press **3**.

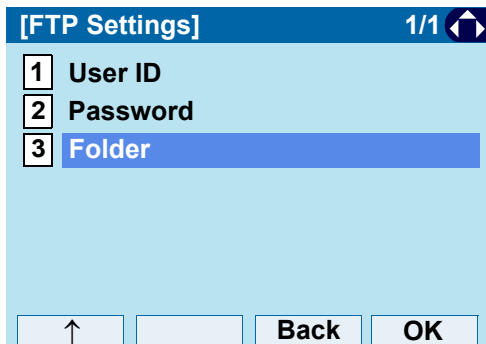

STEP 13: Enter the directory where the download file is stored.

After entering the directory, press  or **OK**.

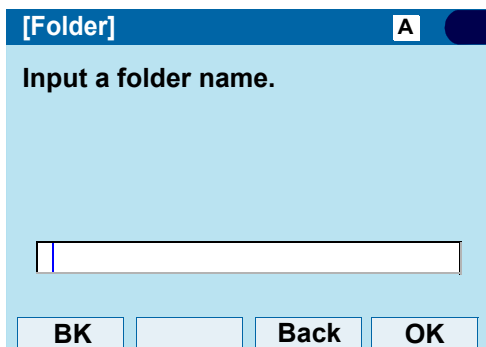

TIP

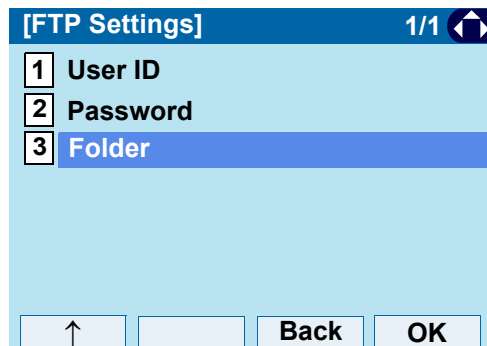

For details on character entry method, see [How to Input Characters](#).

STEP 14: The display returns to the **FTP Settings** screen. Press  or **Back** to display the **Download Menu** screen.



STEP 15: Select **2 Download Address**.

Select an item by one of the following operations.

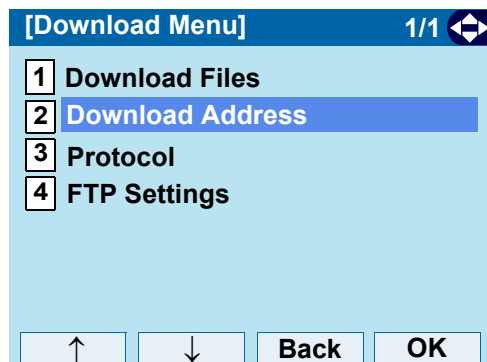

- Highlight an item by using , and press ,  or **OK**.
- Press **2**.

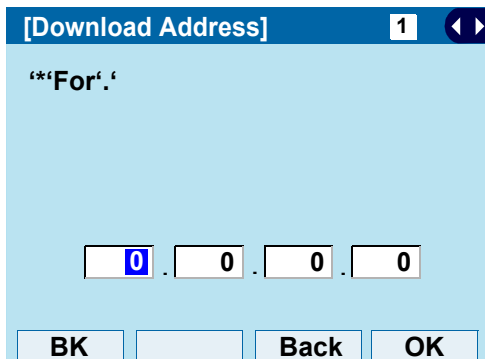

STEP 16: Enter an **IP address** of the FTP/TFTP server which stores the download file.
For example, to set the IP address of 10.41.208.205, enter 10*41*208*205 [separate with an asterisk (*)].



STEP 17: The display returns to the **Download Menu** screen. Select **1 Download Files**.
Select an item by one of the following operations.

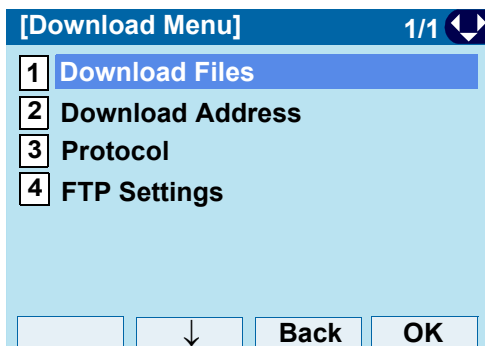

- Highlight an item by using , and press ,  or **OK**.
- Press **1**.



STEP 18: Select file to be downloaded.

When downloading a file for Music on Hold	Select 1 Hold Music and go to STEP 20 .
When downloading a file for ringer tone	Select 2 Ring Tone and go to STEP 19 .
When downloading a file for directory	Select 3 Directory and go to STEP 20 .
When downloading a file for Wallpaper	Select 4 Directory and go to STEP 20 .

STEP 19: When **2 Ring Tone** is selected at STEP 18, the following **Ring Tone** screen is displayed. Select either **1 Download 1**, **2 Download 2** or **3 Download 3**.
Select an item by one of the following operations.

- Highlight an item by using , and press ,  or **OK**.
- Press **1** - **3**.

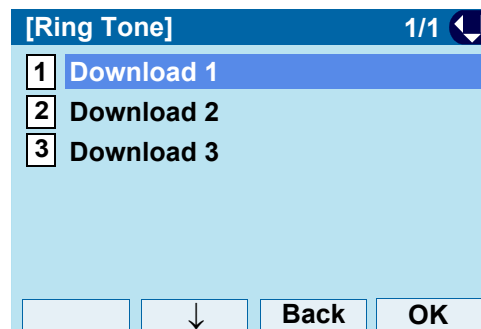

STEP 20: The default file name will be displayed.

When downloading a file for Music on Hold, the default file name is **MOH.wav**.

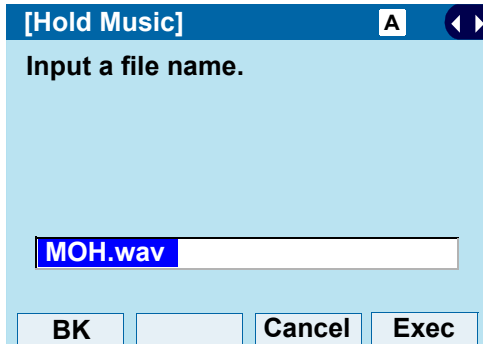

File Format	Maximum Size
PCM μ -law 8kHz/s wav.	under 32 seconds

When downloading a file for ringer tone, the default file name is **Melody1/2/3.wav**.

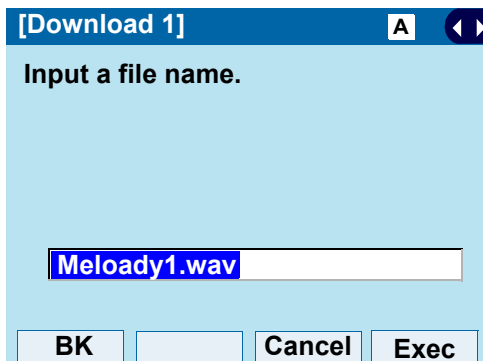

File Format	Maximum Size
PCM μ -law 8kHz/s wav.	under 32 seconds

When downloading a file for Directory, the default file name is **Directory.csv**.

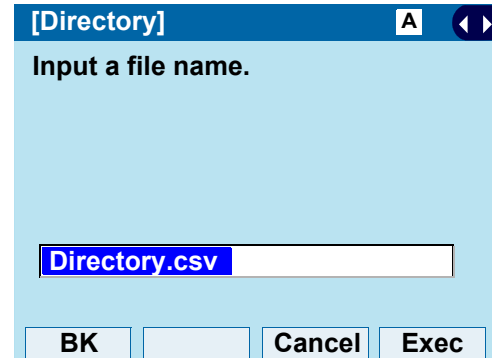

File Name	Directory.csv (Fixed)
Code	Unicode (UTF-8)

When downloading a file for Wallpaper, the default file name is **WallPaper.bmp**.

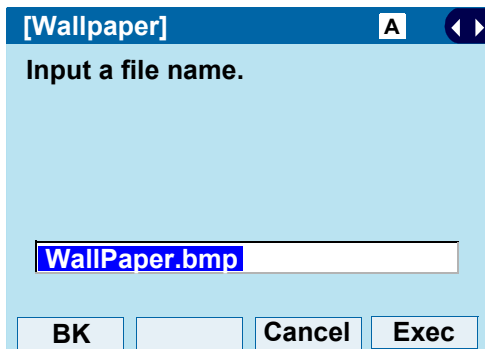

File Format	Maximum Size
bmp/jpg/gif/png	320 X 240 Pixels 230 Kbyte

If changing the file name, continue with STEP 21.

If not changing the file name, proceed to [STEP 22](#).

STEP 21: Press **BK** once to delete the default file name and enter a new file name by using the digit keys.

Note: A maximum of 20 characters ("0-9", "A-Z", "a-z", "*", "#", ".", "-", or "_") can be entered as a file name.

TIP For details on character entry method, see [How to Input Characters](#).

TIP To delete an entered character, press **BK**.

STEP 22: Press  or **Exec** to start the downloading process.

While downloading a file, the LCD displays "Downloading..." first and "Saving...".

Note: While "Saving..." is displayed on the LCD, do not to power OFF the DT730G.

STEP 23: When the downloading process completes, the following is displayed.

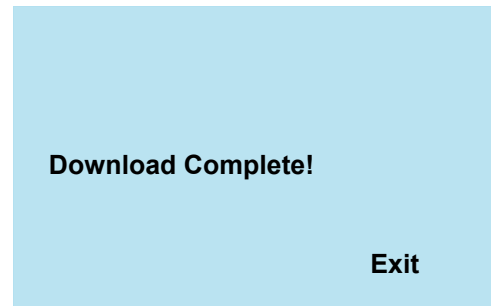

STEP 24: The display returns to the **Download Files** screen upon **Exit**.

Note: When the downloading process ends in failure, **Downloading Failed!** is displayed on the LCD. Check the following and retry.

Check Points	Actions
Download file is not placed in the specified directory.	Place the download file in the specified directory.
A different file name is specified between DT730G and FTP/TFTP server.	Set the same file name from both DT730G and FTP/TFTP server.
Incorrect IP address of FTP/TFTP server has been entered from the telephone.	Set the proper IP address of FTP/TFTP server.
The power to FTP/TFTP server or network equipment is Off.	Turn On the power.
LAN cable is disconnected.	Reconnect the cable securely.

• Backup Personal Settings

You can backup personal settings of DT730G to FTP/TFTP server. To back up the setting data, the DT730G needs to be connected to the network that has FTP (TFTP server).

Note: For details on the XML service, contact the System Administrator.

STEP 1: Set up the FTP/TFTP server.

<FTP server>

Confirm the designated directory (for Windows IIS, the default is "C:\InetPub\ftproot") for the backed up file.



<TFTP server>

Specify a desired destination directory for the backed up file.

STEP 2: Display the **Menu** screen, select **Setting**.

STEP 3: Select **3 Data Backup/Restore**.

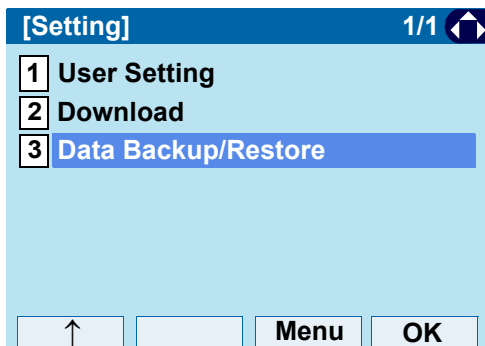

Select an item by one of the following operations.

- Highlight an item by using , and press , or **OK**.
- Press **3**.



STEP 4: Select **4 Protocol**.

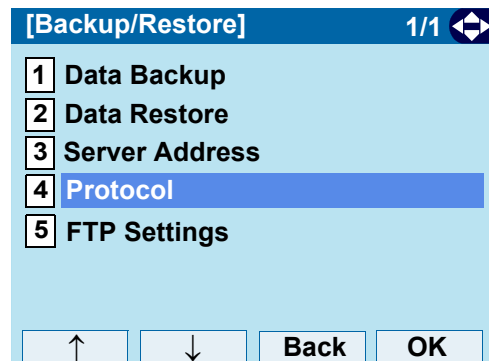

Select an item by one of the following operations.

- Highlight an item by using , and press , or **OK**.
- Press **4**.



STEP 5: Choose a protocol used by the destination server.

Select an item by one of the following operations.

- Highlight an item by using , and press  or **OK**.
- Press **1** or **2**, and press  or **OK**.

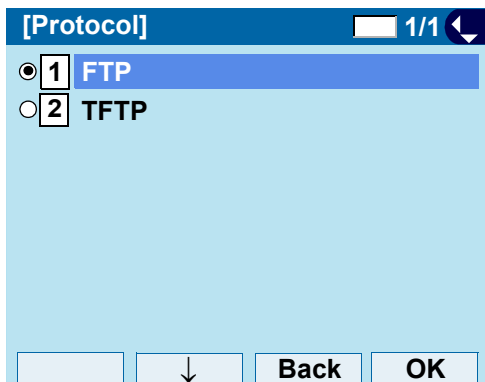



STEP 6: The display returns to the **Backup/Restore** screen.

If **1 FTP** is selected, continue to with STEP 7.

If **2 TFTP** is selected, proceed to [STEP 15](#).

STEP 7: Select **5 FTP Settings**.

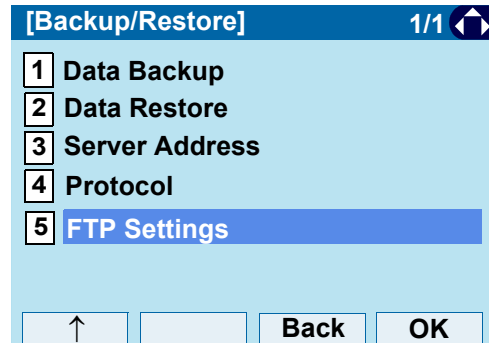

Select an item by one of the following operations.

- Highlight an item by using , and press ,  or **OK**.
- Press **5**.



STEP 8: Select **1 User ID**.

Select an item by one of the following operations.

- Highlight an item by using , and press ,  or **OK**.
- Press **1**.

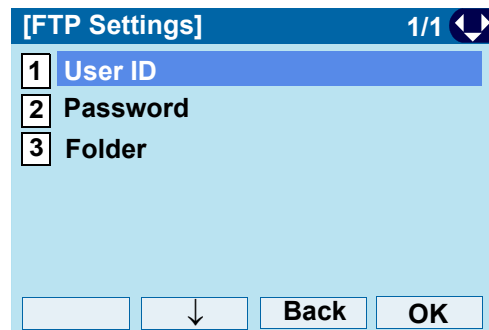

STEP 9: Enter a **Used ID**.

Enter a User ID by using digit keys, then press  or **OK**.

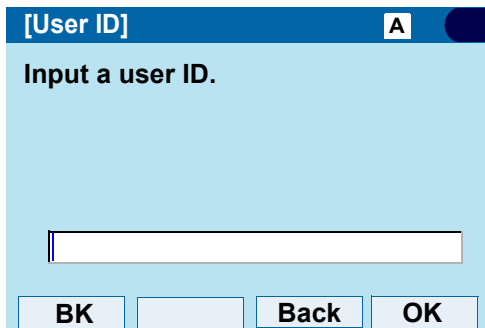

TIP

For details on character entry method, see [How to Input Characters](#).

STEP 10: The display returns to the **FTP Settings** screen. Select **2 Password**.

Select an item by one of the following operations.

- Highlight an item by using , and press , or **OK**.
- Press **2**.

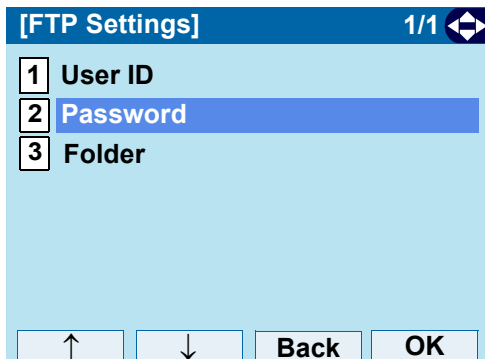

STEP 11: Enter a password.

Enter a password by using digit keys, and press or **OK**.

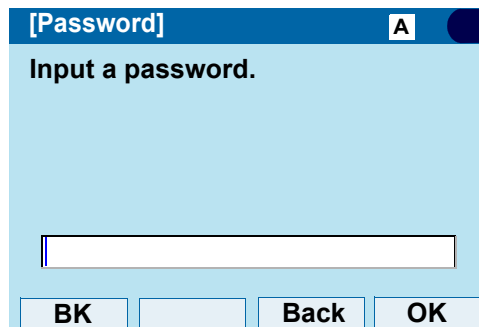

STEP 12: The display returns to the **FTP Settings** screen. Select **3 Folder**.

Select an item by one of the following operations.

- Highlight an item by using , and press , or **OK**.
- Press **3**.

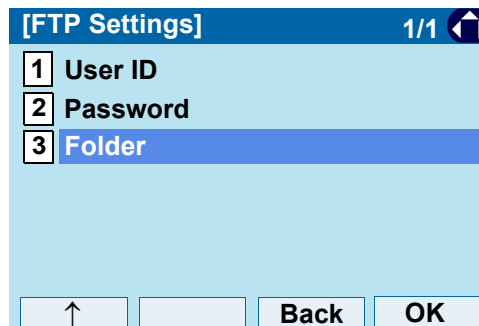

STEP 13: Enter the destination directory of the FTP/TFTP server.

After entering the directory, press  or **OK**.

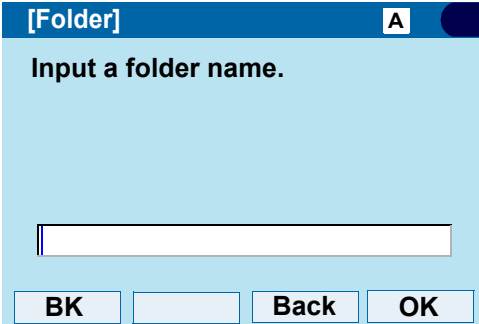

TIP

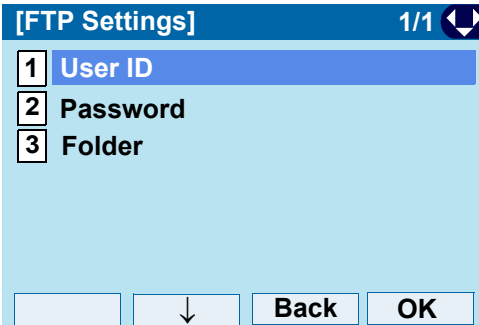

For details on character entry method, see [How to Input Characters](#).

STEP 14: The display returns to the **FTP Settings** screen. Press  or **Back** to display the **Backup/Restore** screen.



STEP 15: Select **3 Server Address**.

Select an item by one of the following operations.

- Highlight an item by using , and press ,  or **OK**.
- Press **3**.

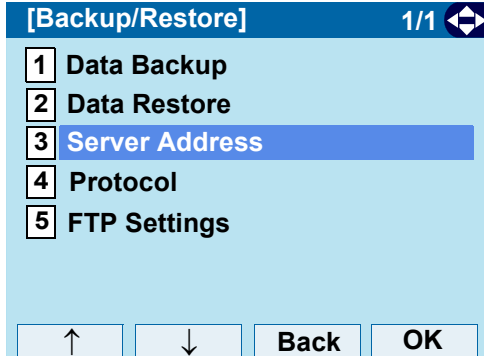

STEP 16: Enter an **IP Address** of the destination FTP/TFTP server.

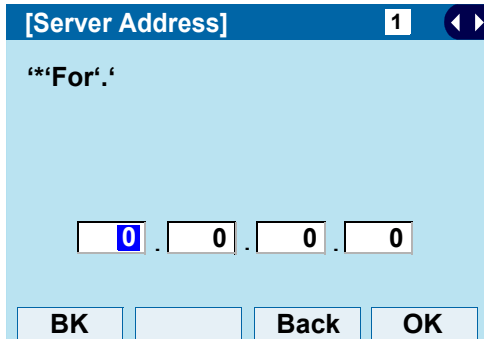

For example, to set the IP address of 10.41.208.205, enter 10*41*208*205 [separate with an asterisk (*)].



After entering an **IP Address**, press  (**Enter**) or **OK**.

STEP 17: The display returns to the **Backup/Restore** screen. Select **1 Data Backup**.

Select an item by one of the following operations.

- Highlight an item by using , and press ,  or **OK**.
- Press **1**.

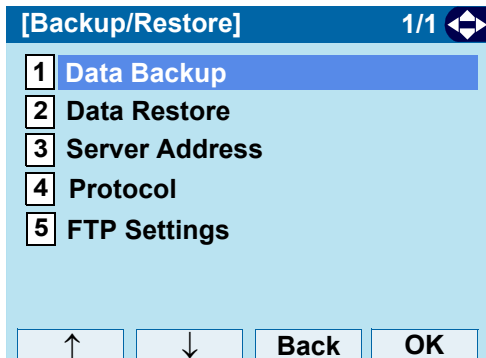

STEP 18: The default file name is displayed as follows:

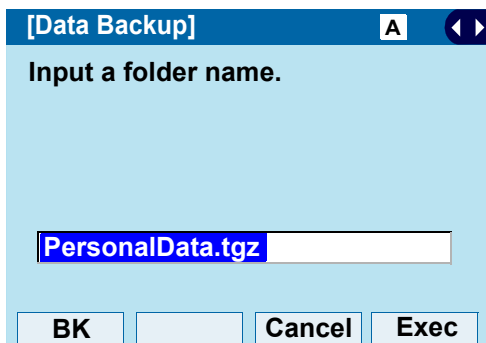

Note: Do not change the extension of the backup file. The setting data of the telephone can only be backed up as a.tgz file.

Note: A maximum of 20 characters ("0-9", "A-Z", "a-z", "*", "#", ".", "-" or "_") can be entered as a file name.

TIP

When changing the default file name, press **BK** once to delete the default file name and enter a new file name by using the digits keys.

TIP

For details on character entry method, see [How to Input Characters](#).

TIP

To delete an entered character, press **BK**.

STEP 19: Press  or **Exec** to start the data backup. While making a backup copy, the LCD displays "Uploading...", and when the data backup completes, LCD displays **Upload Complete!**. If the data backup failed, LCD displays **Upload Failed!**.

STEP 20: After the data backup completes, the display changes to the following:

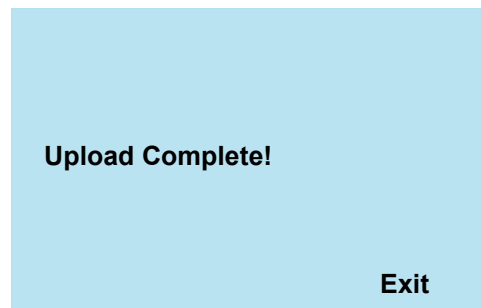

STEP 21: The display returns to the **Backup/Restore** screen upon **Exit**.

Note: When the data backup ends in failure, **Upload Failed!** is displayed on the LCD. Check the following and retry.

Check Points	Actions
Incorrect IP address of FTP/TFTP server has been entered from the telephone.	Set the proper IP address of FTP/TFTP server.
The power to FTP/TFTP server or network equipment is Off.	Turn On the power.
LAN cable is disconnected.	Reconnect the cable securely.

• Restore Personal Settings

User can restore the personal settings of DT730G. To download the backup file to the telephone, the DT730G needs to be connected to the network that has FTP (TFTP server).

Note: For details on the XML service, contact the System Administrator.

Before starting the download, the IP Address of the FTP/TFTP Server must be entered from DT730G.

STEP 1: Set up the FTP/TFTP server.

<FTP server>

Put the backup file you want to restore into the designated directory (for Windows IIS, the default is "C:\inetPub\ftproot") of the FTP server.



<TFTP server>

Put the backup file you want to restore into a desired directory of TFTP server and specify it as the directory for downloading.

STEP 2: Display the **Menu** screen, select **Setting**.

STEP 3: Select **3 Data Backup/Restore**.

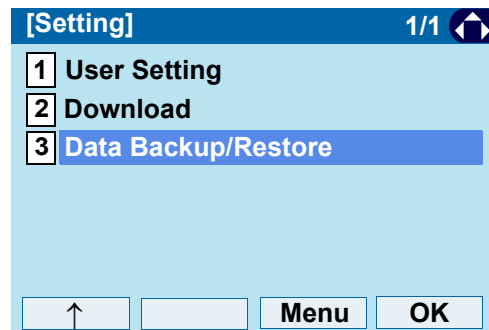

Select an item by one of the following operations.

- Highlight an item by using , and press , or **OK**.
- Press **3**.



STEP 4: Select **4 Protocol**.

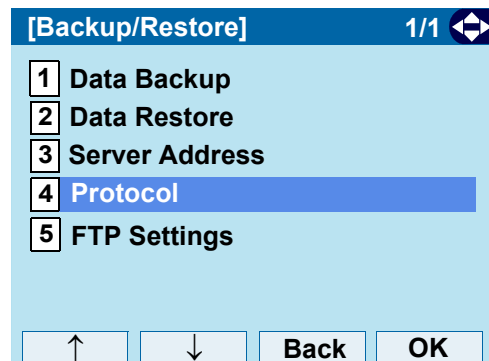

Select an item by one of the following operations.

- Highlight an item by using , and press , or **OK**.
- Press **4**.



STEP 5: Choose a protocol used by the server which stores the backup file.

Select an item by one of the following operations.

- Highlight an item by using , and press  or **OK**.
- Press **1** or **2**, and press  or **OK**.

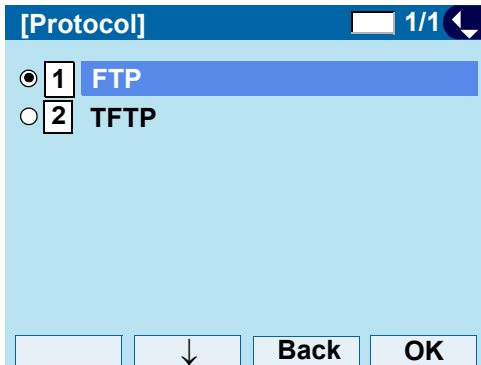



STEP 6: The display returns to the **Backup/Restore** screen.

If **1 FTP** is selected, continue with STEP 7.

If **2 TFTP** is selected, proceed to [STEP 15](#).

STEP 7: Select **5 FTP Settings**.

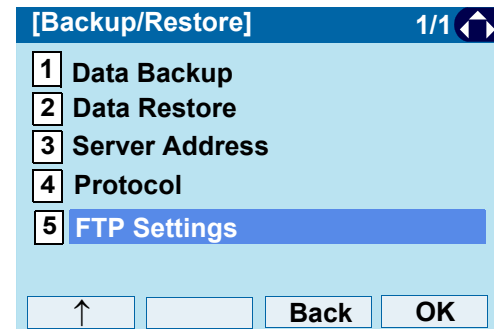

Select an item by one of the following operations.

- Highlight an item by using , and press ,  or **OK**.
- Press **5**.



STEP 8: Select **1 User ID**.

Select an item by one of the following operations.

- Highlight an item by using , and press ,  or **OK**.
- Press **1**.

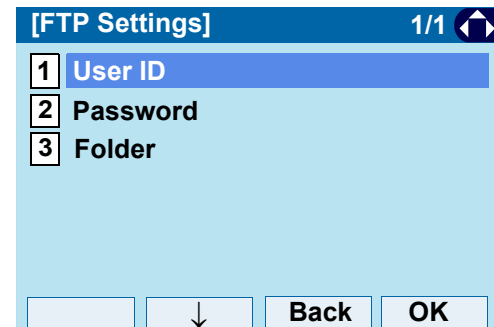

STEP 9: Enter a User ID.

Enter a User ID by using digit keys, then press  or **OK**.

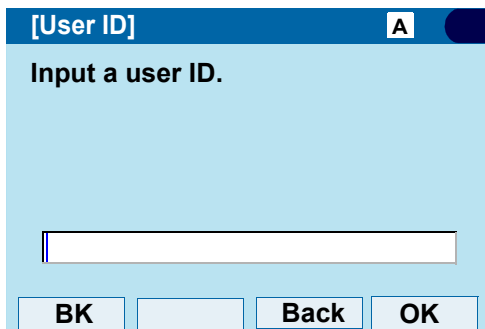



TIP

For details on character entry method, see [How to Input Characters](#).

STEP 10: The display returns to the FTP Settings screen. Select **2 Password.**

Select an item by one of the following operations.

- Highlight an item by using , and press ,  or **OK**.
- Press **2**.

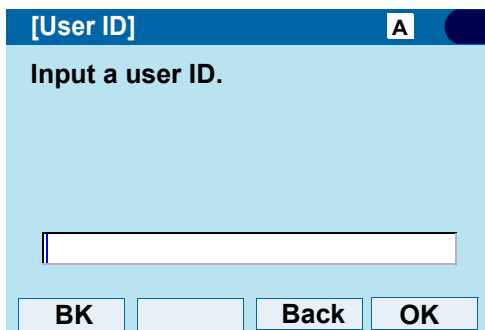

STEP 11: Enter a password.

Enter a password by using digit keys, and press  or **OK**.

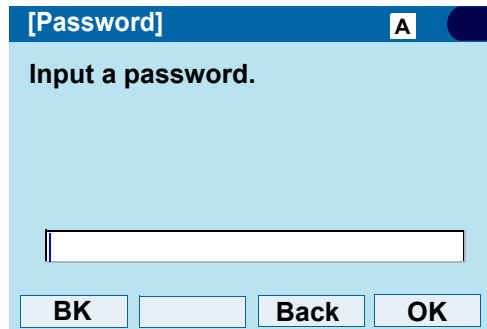



TIP

For details on character entry method, see [How to Input Characters](#).

STEP 12: The display returns to the FTP Settings screen. Select **3 Folder.**

Select an item by one of the following operations.

- Highlight an item by using , and press ,  or **OK**.
- Press **3**.

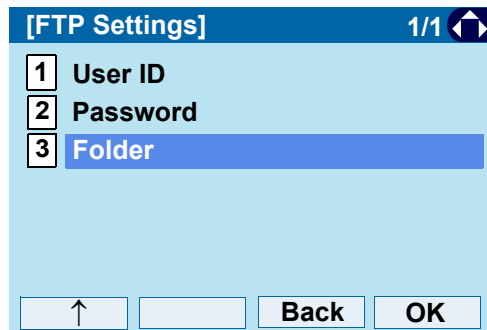

STEP 13: Enter the directory where the backup file is stored.
Enter the directory and press  or **OK**.

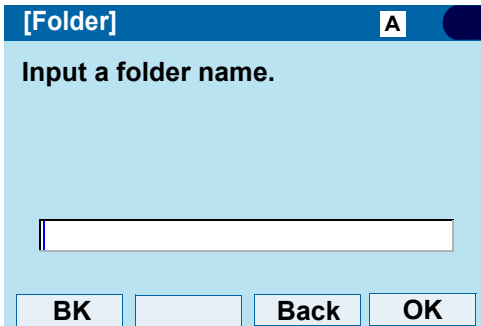

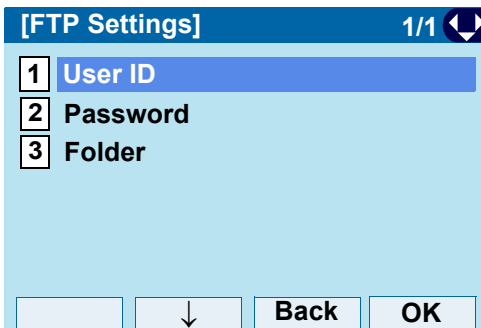

TIP For details on character entry method, see [How to Input Characters](#).

STEP 14: The display returns to the **FTP Settings** screen. Press  or **Back** to display the **Backup/Restore** screen.



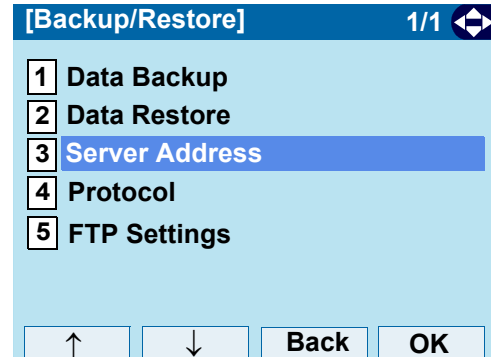

STEP 15: Select **3 Server Address**.
Select an item by one of the following operations.

- Highlight an item by using , and press ,  or **OK**.
- Press **3**.



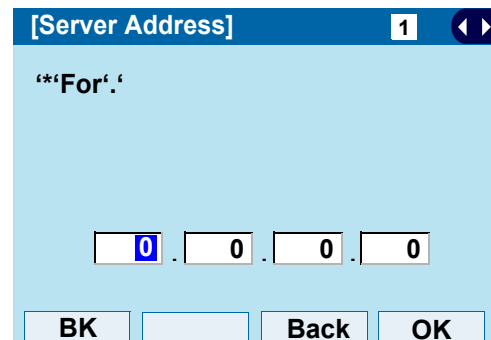

STEP 16: Enter an IP Address of the FTP/TFTP server which stores the backup file.
For example, to set the IP address of 10.41.208.205, enter 10*41*208*205 [separate with an asterisk (*)].



After entering an IP address, press  or **OK**.

STEP 17: The display returns to the **Backup/Restore** screen. Select **2 Data Restore**.

Select an item by one of the following operations.

- Highlight an item by using , and press ,  or **OK**.
- Press **2**.

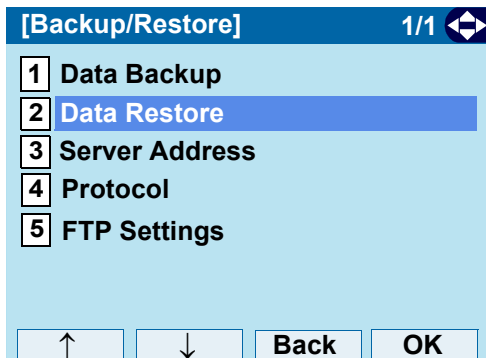

STEP 18: The default name is displayed as follows:

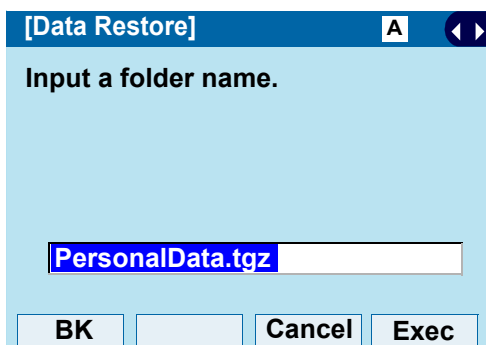

Note: Do not change the extension (.tgz) of the backup file. If the extension is changed, the file cannot be restored properly.

Note: A maximum of 20 characters ("0-9", "A-Z", "a-z", "*", "#", ".", "-", "_") can be entered as a file name.

TIP When changing the default file name, press **BK** once to delete the default file name and enter a new file name by using the digits keys.

TIP For details on character entry method, see [How to Input Characters](#).

TIP To delete an entered character, press **BK**.

STEP 19: Press  or **Exec** to start restoring the backup data to the telephone. While downloading the backup data, the LCD displays "Downloading..." first and "Saving..."

Note: Do not power OFF the DT730G while "Saving..." is displayed on the LCD.

STEP 20: After the download process completes, the display changed to the following:

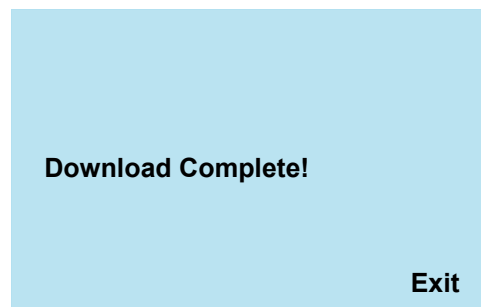

This page is for your notes.

3. BASIC OPERATION

This chapter describes the basic operation of the DT730G.

To Login

STEP 1: When login mode is activated, the telephone prompts for Login ID and Password.

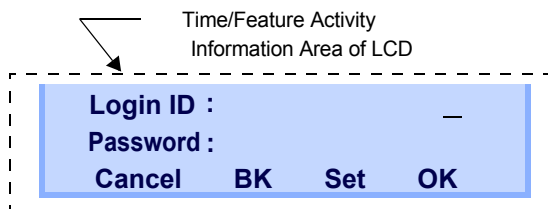

STEP 2: Enter Login ID and press **Set**.
(Station number is usually used as the Login code.)



STEP 3: Enter a password and press **OK**.



STEP 4: If the Login ID and password is accepted, display changes to normal idle status.

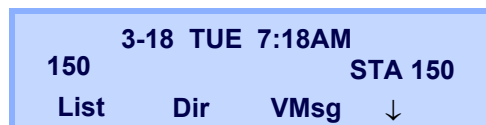

To Logout

STEP 1: Press ↓ (Down Arrow) on the terminal, then press **Prog**.

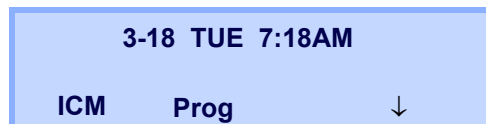

STEP 2: Press ↓ (Down Arrow) three times, then press **LOGOFF**.



STEP 3: **LOGOFF THE SYSTEM?** is displayed on the LCD of the terminal.

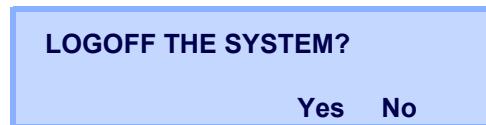

STEP 4: Press the **Yes** softkey.

To Make an External Call

When dialed telephone number is registered in Personal Directory, the corresponding name information will be displayed on LCD while you are hearing a ringback tone or are engaged in a conversation. According to the initial settings, the display may differ from the following examples. For more information, contact the System Administrator.

STEP 1: Lift the handset or press , and you will receive a dial tone.

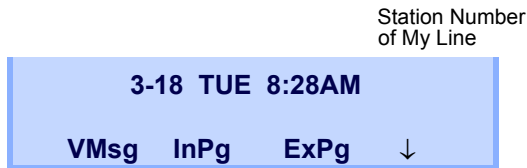

STEP 2: Dial the Central Office access code, e.g. **9**.



STEP 3: Dial desired telephone number.
(while hearing a ringback tone)

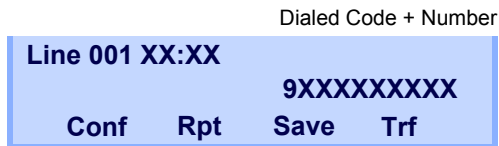

STEP 4: Use handset or MIC to start a conversation.

To Make an Internal Call

When dialed station number is registered in Personal Directory, the corresponding name information will be displayed on LCD while you are hearing a ringback tone or are engaged in a conversation. According to the initial settings, the display may differ from the following examples. For more information, contact the System Administrator.

STEP 1: Lift handset or press , and you will receive a dial tone.

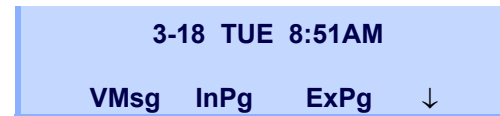

STEP 2: Dial a desired station number. Display indicates the dialed number.
(while hearing a ringback tone)



STEP 3: Use the handset or MIC to start a conversation.

To Answer an External Call

STEP 1: You hear the ringing tone. The Call Indicator Lamp flashes red.

```
Line 001
ABC Corp      XXXXXXXXXXXX
List   Dir    VMsg   ↓
```

STEP 2: Press **Answer**.

STEP 3: Speak into the MIC or lift the handset to answer the call.

To Answer an Internal Call

The following procedure explains how to answer an internal call routed to the telephone.

STEP 1: You hear the ringing tone. The Call Indicator Lamp flashes red.

```
3-18 TUE 8:30AM
Call From      STA 101
List   Dir    VMsg   ↓
```

STEP 2: Press **Answer**.

STEP 3: Speak into the MIC or lift the handset to answer the call.

To Hold a Call

STEP 1: While engaged in a Two-party call:

STEP 2: Press **HOLD** to hold the call in progress.

```
3-18 TUE 8:30AM
Hold          STA 101
VMsg  InPg  ExPg  ↓
```

STEP 3: The person on the other end hears the music on hold.

STEP 4: Replace the handset.

• To Retrieve

STEP 1: Press the **ICM** key if it is an internal call or the line key or CAP key if it is a trunk call.

STEP 2: Lift the handset or press **Speaker**.

• If Unanswered

TIP Any station with this line appearance can retrieve the call.

STEP 1: After preprogrammed time, Automatic Recall is initiated.

STEP 2: Call Indicator lamp flashes and the user hears Automatic Recall Ringer.

To Transfer a Call

STEP 1: During a conversation, press **Transfer**. Receive Special Dial Tone. The first party is placed on hold and hears the music on hold.

3-18 TUE 8:30AM			
Hold		STA 101	
VMsg	InPg	ExPg	↓

STEP 2: Dial the destination party's number. Receive Ringback Tone.

3-18 TUE 8:30AM			
Calling		STA 102	
VMsg	Trf	Rls	

STEP 3: The destination party answers the call. Announce the call to the destination party.

STEP 4: Replace the handset. The transfer is complete.

One-Touch Speed Calling Keys

• To Make a Call

STEP 1: Press the desired **One-Touch Speed Calling** key.

STEP 2: **Speaker** lamp lights red. A call is automatically made.

STEP 3: Lift the handset. **Speaker** lamp goes off.

• To Set

STEP 1: Press **Speaker**.

STEP 2: Dial **751**.

STEP 3: Press the desired **One-Touch Speed Calling** key.

STEP 4: Dial **01** + the desired telephone number or feature access code on the keypad. Display indicates the digits dialed.

STEP 5: Press **HOLD** to save the number.

Key Program	KEY 12
DSS/ONE TOUCH	101

• To Verify

STEP 1: Press **Help**.

STEP 2: Press the desired One-Touch Speed Calling key.

STEP 3: Display indicates the assigned number.

Check	LINE KEY 12
DSS/ONE TOUCH	101

STEP 4: Press **Exit** to return to the idle screen.

STEP 3: Press **#**. The number on the display is automatically redialed.

Note: *A-law Countries [Europe, Australia, Russia, Latin America, Middle near East, other Asian nations]: #*
*μ-law Countries [North America]: **

Note: *The key to redial (#, *) can be changed by the system setting. For details, contact the System Administrator.*

STEP 4: When party has answered, lift handset or speak hands-free.

Redial

Note: *When Redial feature is enabled at installation, Last Number Redial feature and Speed Calling features using  (Redial) key are not available. For details, contact the System Administrator.*

• To Delete a Call Record from the Outgoing Call History

STEP 1: Press  (Redial). The last number dialed is displayed.

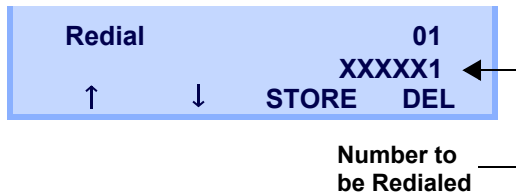

STEP 2: Press  or ↑/↓ until a desired number is displayed.

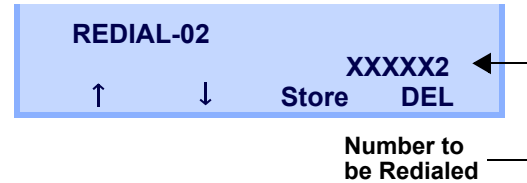



STEP 3: Press **DEL** soft key.

STEP 4: Press **One** soft key.



• To Delete All Records from the Outgoing Call History

STEP 1: Press  (Redial). The user hears Dial tone and the last number dialed is displayed.
 lamp lights red.

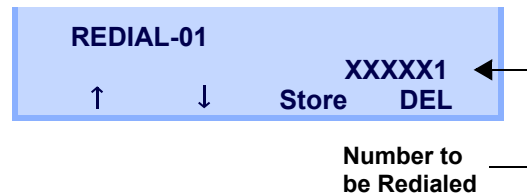

STEP 2: Press **DEL** soft key.

STEP 3: Press **All** soft key.

REDIAL-01		XXXXX1
One	All	

Voice Call

- **Using Soft Key**

STEP 1: Lift handset.

STEP 2: Dial desired station number; **Voice** appears while station is ringing.

3-18 TUE 8:30AM			
CALLING		STA 101	
Voice	MW	VMsg	↓

STEP 3: Press **VOICE** soft key. Speak to called party.

Three-Party Conference

STEP 1: While Station A and Station B are engaged in a Two-party connection, Station A presses **Conf** softkey.

Station A hears Special Dial Tone.

Station B hears the music on hold.

3-18 TUE 8:30AM	
TALKING TO	STA 101
Conf	

STEP 2: Station A dials a desired Station Number (Station C).

Station Number of Station C	
3-18 TUE 8:30AM	
TALKING TO	STA 105
Add	Rls

STEP 3: After Station C answers the transferred call, Station A presses **Add** softkey.

Station Number of Station C	
ICM Dial	CONF
Begin	Dir

STEP 4: Station A presses the **Begin** softkey.

STEP 5: Three-Party call is now established.

Voice Mail System

- **To Originate**

STEP 1: Press  (Enter). The Shortcut menu screen is displayed on LCD.

STEP 2: Select **2** **Voice Mail** to access a preset Voice Mail System.

Do Not Disturb

- **To Set**

STEP 1: Press ↓ (Down Arrow), then **Prog** when the telephone is in idle state (on-hook).

```
3-18 TUE 8:30AM
101          STA 101
ICM   Prog
```

STEP 2: Press **DND**.

```
PGM/SAVE-MENU
Cfwd   DND   STA   ↓
```

STEP 3: Press **Set**.

```
SET DND
Set   Cncl
```

STEP 4: Choose DND type.

- **To Cancel**

STEP 1: Press ↓ (Down Arrow), then **Prog**.

```
3-18 TUE 8:30AM
101          STA 101
ICM   Prog
```

STEP 2: Press **DND**.

```
PGM/SAVE-MENU
Cfwd   DND   STA   ↓
```

STEP 3: Press **Cncl**.

```
SET DND
Set   Cncl
```

How to Input Characters

This section explains how to enter characters on the text input screen such as Name or User ID, etc.

• Character Entry Mode

When entering characters from the telephone set, the following three modes are available: uppercase alphabetical character, lowercase alphabetical character and numeric character. The character entry mode can be changed by pressing  (alphabetical / numeric) or from the SubMenu screen (uppercase / lowercase alphabet).

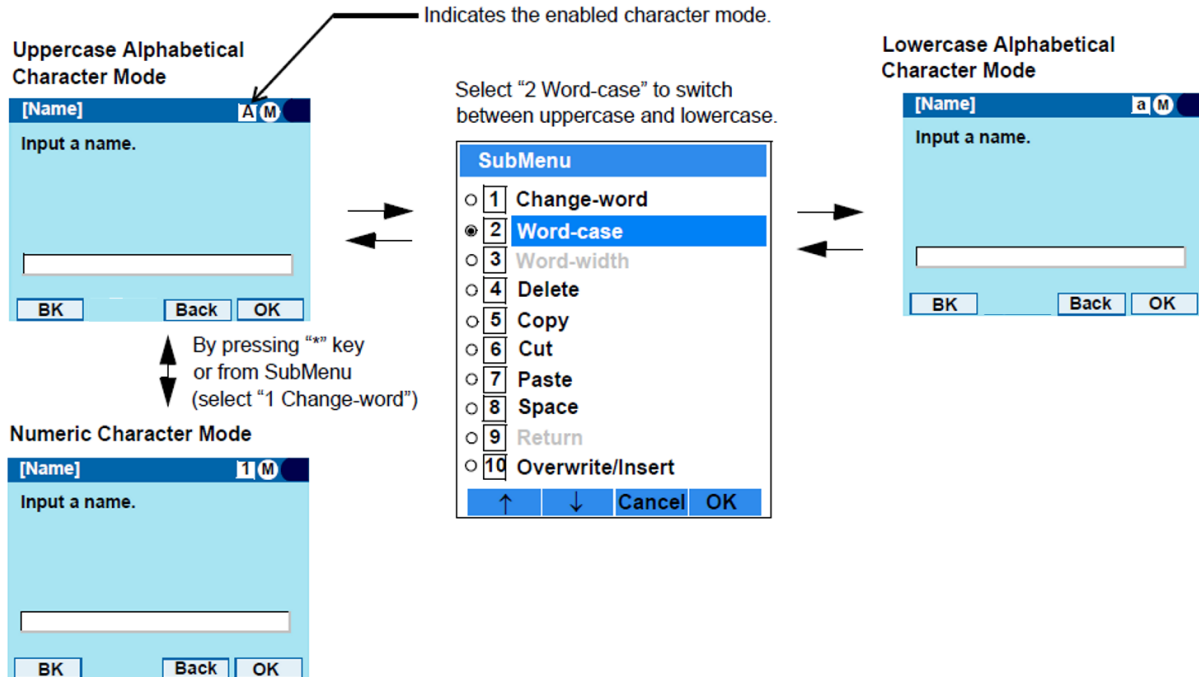

The enabled entry mode is indicated in the top portion of the LCD screen.

To display the SubMenu screen, press **HELP** or **Option** while the text input screen is displayed. Also, the following operations are available from the SubMenu screen.

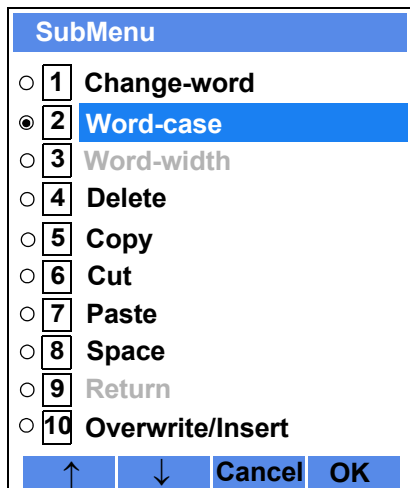

Item	Descriptions
Change-word	Change character entry mode between uppercase alphabetical, lowercase alphabetical and numeric character.
Word-case	Switch between uppercase and lowercase.
Word-width	Not used.
Delete	Delete a single character.
Copy	Copy the specified characters.
Cut	Cut the specified characters.
Paste	Paste the specified characters.
Space	Enter a space.
Return	Start a new line.
Overwrite/Insert	Write over existing characters.

- Character Code List

Character Code for English (1/2)

DIGIT KEY	CASE SHIFT	1st	2nd	3rd	4th	5th	6th	7th	8th	9th	10th	11th	12th	13th
①	A	.	,	\	1	?	!	"	@	:	;			
	a													
②	A	A	B	C	2									
	a	a	b	c	2									
③	A	D	E	F	3									
	a	d	e	f	3									
④	A	G	H	I	4									
	a	g	h	i	4									
⑤	A	J	K	L	5									
	a	j	k	l	5									
⑥	A	M	N	O	6									
	a	m	n	o	6									
⑦	A	P	Q	R	S	7								
	a	p	q	r	s	7								
⑧	A	T	U	V	8									
	a	t	u	v	8									
⑨	A	W	X	Y	Z	9								
	a	w	x	y	z	9								
⑩	A	[SP]	0											
	a													

Character Code for English (2/2)

		1st	2nd	3rd	4th	5th	6th	7th	8th	9th	10th	
# Note	A	*	#	.	/	:	~	!	@	\$	%	
	a											
			11th	12th	13th	14th	15th	16th	17th	18th	19th	20th
	A	^	&	()	'	?	"	_	+	-	
	a											
			21th	22th	23th	24th	25th	26th	27th	28th	29th	30th
	A	=	[]	{	}	<	>	,	;	\	
	a											
*	Note Used as a case shift key. Shifts the characters between alphabetical and numeric.											

Note: (#) and (*) is the same for European languages other than English, including Russian and Turkish.

Character Code for Russian

DIGIT KEY	CASE SHIFT	1st	2nd	3rd	4th	5th	6th	7th	8th	9th	10th	11th	12th	13th	14th	15th
①	A	.	,	:	!	?	+	-	%	&	/	()	=	¿	i
	a															
②	A	А	Б	В	Г											
	a	а	б	в	г											
③	A	Д	Е	Ё	Ж	З										
	a	д	е	ё	ж	з										
④	A	И	Й	К	Л											
	a	и	й	к	л											
⑤	A	М	Н	О	П											
	a	м	н	о	п											
⑥	A	Р	С	Т	У											
	a	р	с	т	у											
⑦	A	Ф	Х	Ц	Ч											
	a	ф	х	ц	ч											
⑧	A	Ш	Щ	Ъ	Ы	Ь										
	a	ш	щ	ъ	ы	ь										
⑨	A	Э	Ю	Я												
	a	э	ю	я												
⑩	A	[SP]														
	a															

Note: ① and ② is the same for English.
Refer to the <Character Code For English (2/2)>.

Character Code for Turkish

DIGIT KEY	CASE SHIFT	1st	2nd	3rd	4th	5th	6th	7th	8th	9th	10th	11th	12th	13th	14th	15th
1	A	.	,	:	!	?	+	-	%	&	/	()	=	ı	i
	a															
2	A	A	B	C	Ç											
	a	a	b	c	ç											
3	A	D	E	F												
	a	d	e	f												
4	A	G	Ğ	H	I	İ										
	a	g	ğ	h	I	i										
5	A	J	K	L												
	a	j	k	l												
6	A	M	N	O	Ö											
	a	m	n	o	ö											
7	A	P	R	S	Ş											
	a	p	r	s	ş											
8	A	T	U	Ü	V											
	a	t	u	ü	v											
9	A	Y	Z													
	a	y	z													
0	A	[SP]														
	a															

Note:

Ⓝ and Ⓢ is the same for English.

Refer to the <Character Code For English (2/2)>.

Character Code for European Languages Other Than English

DIGIT KEY	CASE SHIFT	1st	2nd	3rd	4th	5th	6th	7th	8th	9th	10th	11th	12th	13th	14th	15th
1	A	.	,	:	!	?	+	-	%	&	/	()	=	¿	i
	a															
2	A	A	B	C	À	Á	Â	Ã	Ä	Å	Æ	Ç				
	a	a	b	c	à	á	â	ã	ä	å	æ	ç				
3	A	D	E	F	È	É	Ê	Ë								
	a	d	e	f	è	é	ê	ë								
4	A	G	H	I	Ì	Í	Î	Ï								
	a	g	h	i	ì	í	î	ï								
5	A	J	K	L												
	a	j	k	l												
6	A	M	N	O	Ñ	Ô	Ó	Õ	Ö	Ø	Œ	∅				
	a	m	n	o	ñ	ò	ó	ô	ö	ø	œ	∅				
7	A	P	Q	R	S	ß										
	a	p	q	r	s	ß										
8	A	T	U	V	Û	Ü	Û	Ü								
	a	t	u	v	ù	ü	û	ü								
9	A	W	X	Y	Z											
	a	w	x	y	z											
0	A	[SP]														
	a															

Note: # and * is the same for English.
Refer to the <Character Code For English (2/2)>.

Number Code

DIGIT KEY	CASE SHIFT	1st	2nd	3rd	4th	5th	6th	7th	8th	9th	10th	11th	12th	13th	14th	15th
①	1	1														
②	1	2														
③	1	3														
④	1	4														
⑤	1	5														
⑥	1	6														
⑦	1	7														
⑧	1	8														
⑨	1	9														
⑩	1	0														
#	1	*	#	.	@	/	()	,	-	_	:	'	~	&	\
*	1	Used as a case shift key. Shifts the characters between alphabetical and numeric.														

Note: * When entering password, “0-9”, “*” and “#” are available.

“#” is entered by pressing ⑨.

“*” is entered by pressing ⑩.

• Character Entry Method

The following example of character entry shows how to enter “Ken Kobus”.

STEP 1: Press **5** twice to enter “K”.

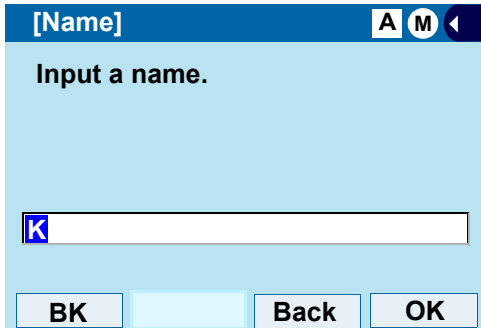

STEP 2: Press **HELP** to display SubMenu screen, and select **2 Word-case** to switch the text input mode from uppercase to lowercase.

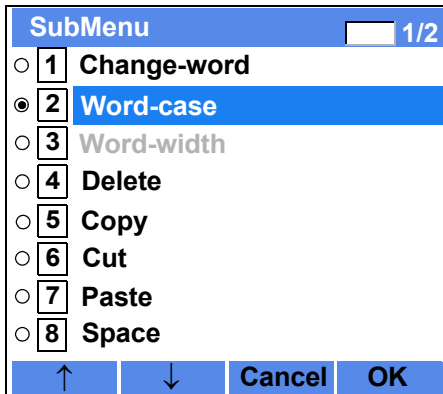

STEP 3: Press **Enter** or **OK** on the SubMenu to

go back to the text input screen.

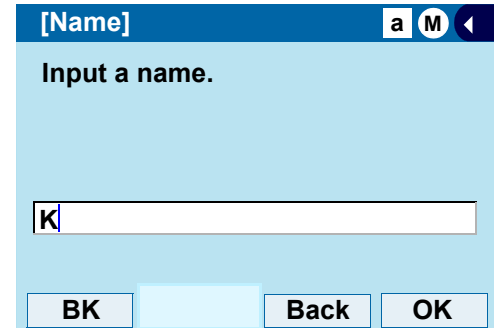

STEP 4: Enter “en” by using digit keys.

Press **3** twice to enter “e”.

Press **6** twice to enter “n”.

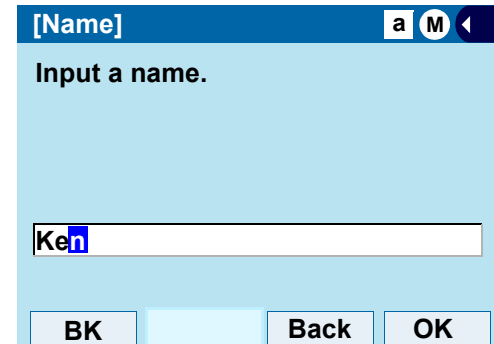

STEP 5: Press **0** once to enter a space.

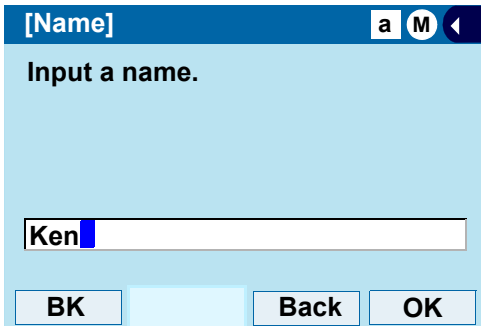

STEP 6: Press **HELP** or to display SubMenu screen, and select **2 Word-case** to switch the text input mode from lowercase to uppercase.

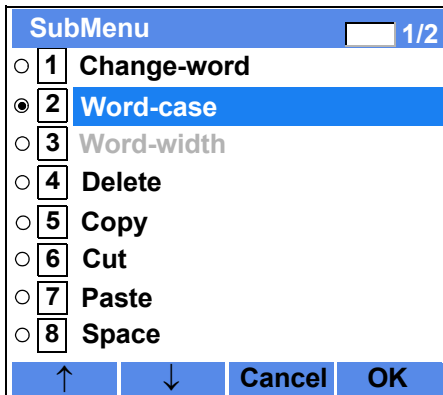

STEP 7: Press **(Enter)** or **OK** on the SubMenu to go back to text input screen.

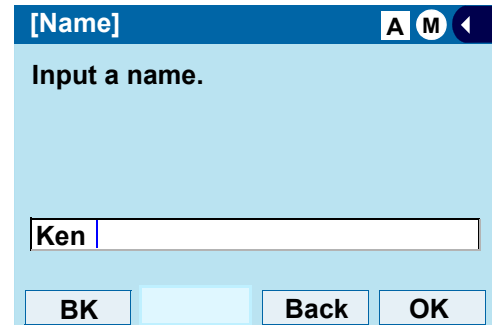

STEP 8: Press **5** twice to enter "K".

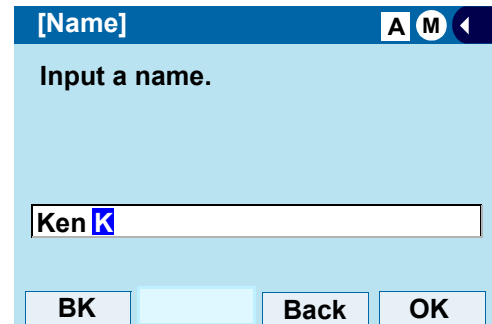

STEP 9: Press **HELP** to display SubMenu screen, and select **2 Word-case** to switch the text input mode from lowercase to uppercase.

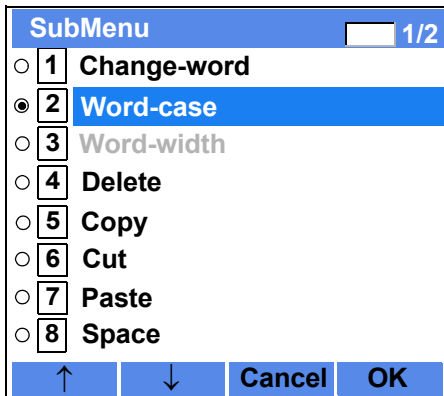

STEP 10: Press (Enter) or **OK** on the SubMenu to go back to text input screen.

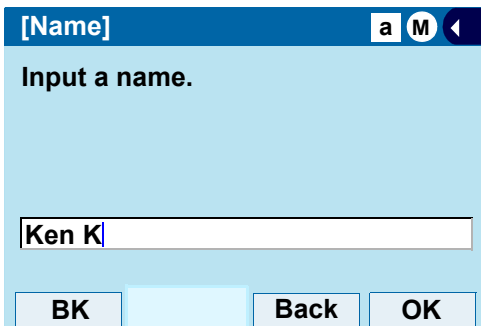

STEP 11: Enter “obus” by using digit keys.

Press three times to enter “o”.

Press twice to enter “b”.

Press twice to enter “u”.

Press four times to enter “s”.

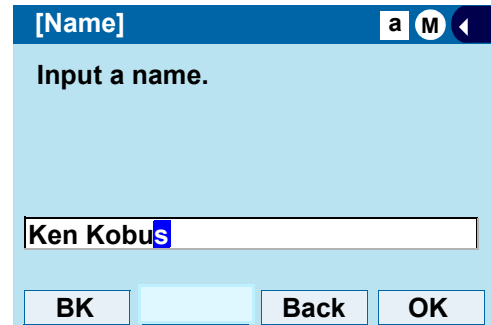



STEP 12: Press (Enter) or **OK**.

• To Overwrite Characters

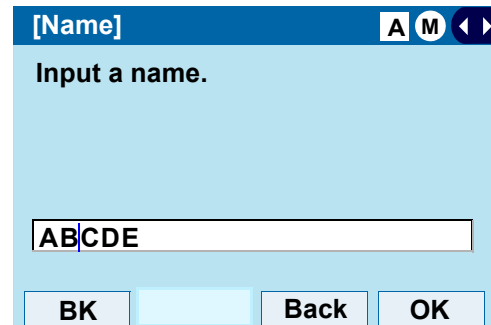
STEP 1: Place the cursor at the left of the characters to be overwritten.



STEP 2: Press **HELP** or **Option**.

STEP 3: On the following SubMenu screen, select **10 Overwrite/Insert** and press  (Enter),  (Right-cursor) or **OK**.

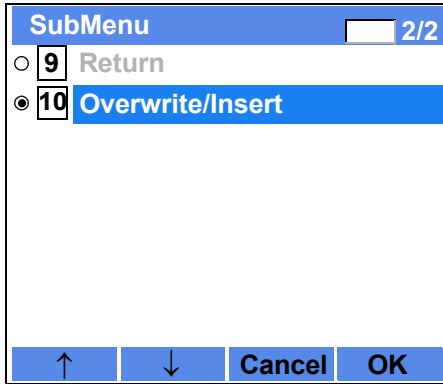

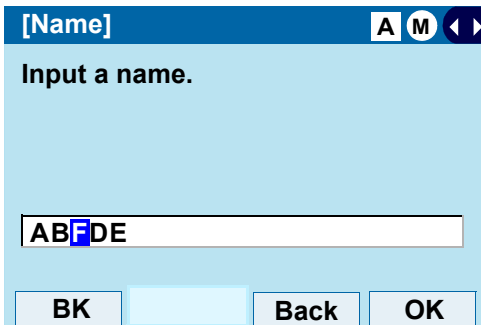

STEP 4: Enter new words over existing characters. In this example, "F" is entered.



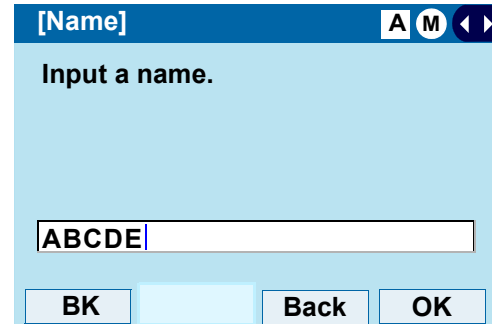

• To Copy and Paste Characters

STEP 1: While characters which you want to copy are displayed, press **HELP**.

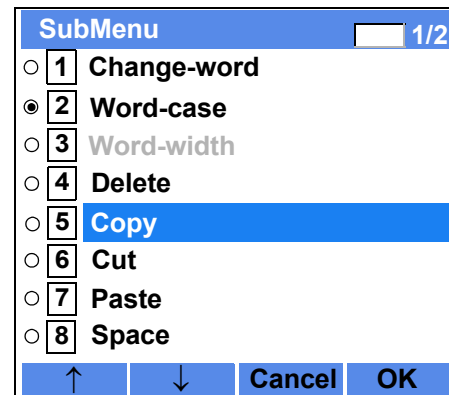

STEP 2: On the SubMenu screen, press  (Enter) or **OK** while **5 Copy** is highlighted, or press **5**.



STEP 3: Place the cursor at the starting point of the target characters by using  (Left-cursor) and press **Start**.

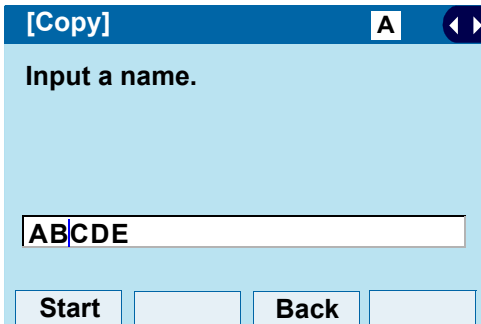

STEP 4: Place the cursor at the end point of the target characters  (Right-cursor) and press **End**.

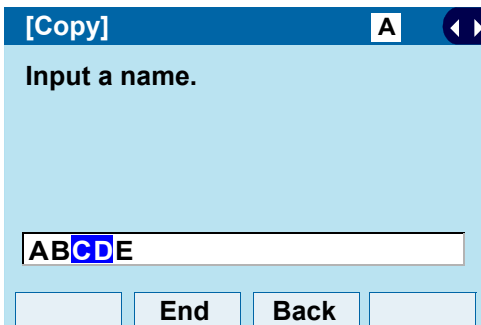

STEP 5: Place the cursor at position where you want to paste the copied characters and press **HELP** or **Option**.

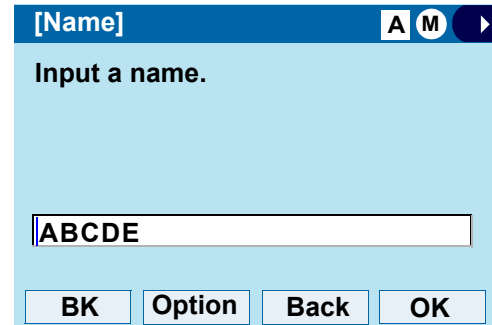

STEP 6: On the SubMenu screen, select **7 Paste** and press  (Enter),  (Right-cursor) or **OK**. (or press **7**).

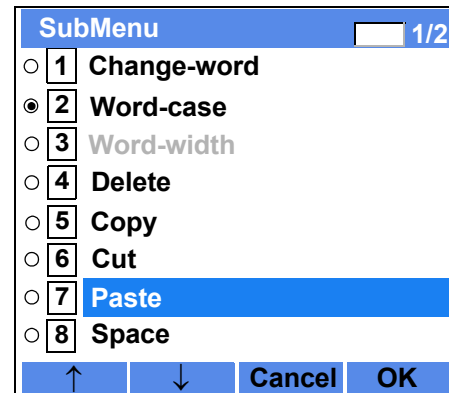

STEP 7: The copied characters “CD” are inserted as follows:

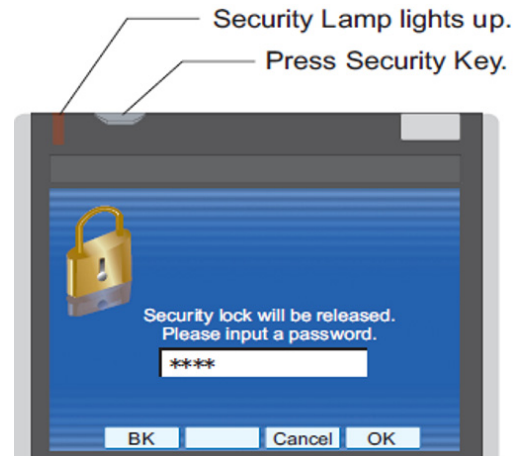
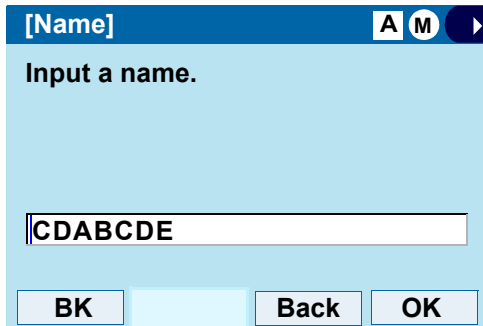

Security Mode

DT730G has a **Security** mode which prevents unauthorized access and information leakage from the terminal. While the terminal is locked, the Security Lamp is lit.

Note: When the System Administrator invalidates the security mode, this function cannot be used. For details of the security mode, contact the System Administrator.

Note: After a third attempt (if left uncorrected, password is entered three times consecutively), the telephone locks up, and any key operation will be disabled for 10 minutes.

Note: While the telephone is locked,  becomes disabled. Also, any features provided by the telephony server, such as call origination or call answering, cannot be performed.

Note: Even when the telephone is reset for any reason (such as power-off, etc.) while the telephone is placed in security mode, the lock is not released.

• To Lock the Telephone

STEP 1: Press **Security** on the telephone. The following message is displayed on LCD.



STEP 2: Press **Enter** or **OK** to place DT730G in Security mode.

STEP 3: When the telephone is placed in Security mode, Security Lamp lights red and the screen saver will be activated.

• To Unlock the Telephone

STEP 1: Display the Password Entry screen by either of the following operations.

Press any key while the screen saver is activated.

Press **Security** while the screen saver is activated.



STEP 2: Enter the password and press **Enter** or **OK**. Security Lamp goes off and Security Mode is canceled.

Note: *The default password to release a security lock is 0000. Be sure to change the default password before placing the telephone in security mode. For details on the password setting, see [Change Password](#) in Terminal Setup.*

TIP

When the password entry ends in failure, the following error message is issued. In that case, press **Enter** or **OK** and retry.

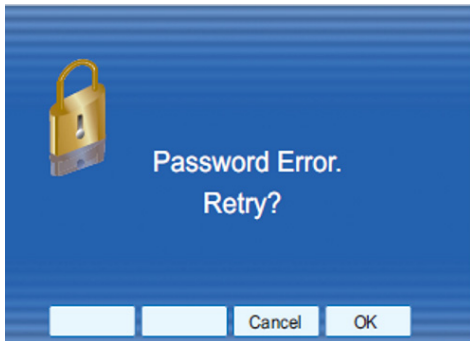

TIP

After a third attempt (if incorrect password is entered three times consecutively), the following error message is issued. Press  or **OK**. The telephone locks up, and any key operation will be disabled for 10 minutes. Wait for 10 minutes, make a retry. Please note emergency calls cannot be completed during the 10 minutes terminal lock out period.



Phonebook

System Phonebook

The System Phonebook is used on a system basis. The data entry is made by the Telephony Server Administrator.

- **Available Characters in Local Phonebook**

The following tables show the characters available in the Local Phonebook.

Uppercase Character

Digit Code	1	2	3	4	5	6	7	8	9	0	*	#
Character	.	A	D	G	J	M	P	T	W	SP	*	#
	,	B	E	H	K	N	Q	U	X	0		
	:	C	F	I	L	O	R	V	Y			
	!	À	È	Ì	5	Ñ	S	Ù	Z			
	?	Á	É	Í		Ö	β	Ú	9			
	-	Â	Ê	Î		Ó	7	Û				
	+	Ã	Ë	Ï		Ô		Ü				
	%	Ä	3	4		Õ		8				
	&	Å				Ö						
	/	Æ				Œ						
	(Ç				Ø						
)	2				6						
	=											
	¿											
	¡											
1												

SP: Blank Space

Lowercase Character

Digit Code	1	2	3	4	5	6	7	8	9	0	*	#
Character	.	a	d	g	j	m	p	t	w	SP	*	#
	,	b	e	h	k	n	q	u	x	0		
	:	c	f	i	l	o	r	v	y			
	!	à	è	ì	5	ñ	s	ù	z			
	?	á	é	í		ò	β	ú	9			
	:	â	ê	î		ó	7	û				
	\	ä	ë	ï		ô		ü				
	"	â	3	4		õ		8				
	@	æ				ö						
	1	ç				6						
		2										

SP: Blank Space



4. DIRECTORY OPERATION

This chapter explains the DT730G Directory features.

To Add New Data

STEP 1: Press the  key. The menu screen is displayed.

Note: *The Feature key can be used to backspace and delete a character*

STEP 2: Select **Directory** then press  (**Enter**) or **OK** softkey (or press  key).

STEP 3: Select  : **REGIST** and then press  (**Enter**) or press  key.

1: REGIST	2: SEARCH		
3: SETTING	4: DeleteAll		
1:	2:	3:	4:

STEP 4: Select Name or Telephone Number by using Alpha or Num softkey to toggle between the two.

TLBK1: INPUT NAME	[A]
	<
NUM	← →

STEP 5: Enter a name or telephone number to be registered in the directory using the dial pad.

STEP 6: After entering the name or telephone, press the  key.

STEP 7: The following list appears. Select a desired group by entering a number.

TLBK1: SELECT GROUP			
1 :Group 01	2 :Group 02		
3 :Group 03	4 :Group 04		

STEP 8: Enter the telephone number as indicated in the display and press the  key.

TLBK1: INPUT NUMBER
NEC
2142622000

STEP 9: Enter a desired Memory ID.

TLBK1: REGIST MEMORY	>000
[0-449]	

STEP 10: After entering the Memory ID, the display goes back to the main directory screen. Press the **Exit** key.

To Find Registered Data

- STEP 1: Press the **Menu** key. The menu screen is displayed.
- STEP 2: Select **Directory** then press **Enter** (or **OK** softkey (or press **2** key).
- STEP 3: Select **2: Search** then press **Enter** (or press **2** key).

1: REGIST **2: SEARCH**
3: SETTING **4: DeleteAll**
1: **2:** **3:** **4:**

Note: *The display will show No TELBK Data if there are no entries to review.*

TLBK1: SEARCH NAME [A]
<
NUM **MENU**

- STEP 4: Select a search method from the following list.

[SEARCH MENU]
NAME **GRP** **NUM** **MEM**

KEY	DESCRIPTION
Name	Search data from the name list registered in the directory.
Group	Display the lists registered to each group (01~20 groups).
Tel Number	Search data from the telephone number list registered in the directory.
Memory ID	Search data from the memory number registered in the directory.

- STEP 5: The following is an example when NAME, GRP, NUM, and MEM are selected as a search.

NAME
TLBK1: SEARCH NAME [A]
<
NUM **MENU** ← →

GRP
TLBK1: SEARCH GROUP
1 :Group 01 **2 :Group 02**
3 :Group 03 **4 :Group 04**

NUM
TLBK1: SEARCH NUMBER
MENU <

MEM



To Make a Call from Directory

Note: While the Directory screen is being displayed, you cannot make a call by dialing a telephone number.

STEP 1: Press the **Menu** key. The menu screen is displayed.

STEP 2: Select **Directory** then press **Enter** (or **OK** softkey (or press **2** key).

STEP 3: Select **2: Search** then press **Enter** (or press **2** key).



Note: The display will show No TELBK Data if there are no entries to review.

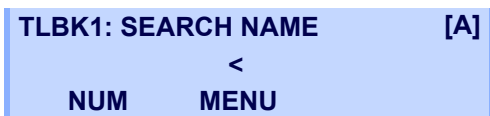

STEP 4: Select a search method (e.g., NAME, GRP, NUM or MEM).

[SEARCH MENU]

NAME GRP NUM MEM

The following display is an example of dial by name.



STEP 5: Lift the **Handset**, press the **Speaker** key or press the **Dial** softkey while displaying the detailed data for target party on LCD.

Note: If multiple telephone numbers are assigned into a target party, a call is made to the first telephone number.

To Add Prefix Number



When making a call, a prefix can be added to telephone numbers to be dialed. Prefixes need to be set in advance.

STEP 1: Press the **Menu** key. The menu screen is displayed.

STEP 2: Select **Setting**.

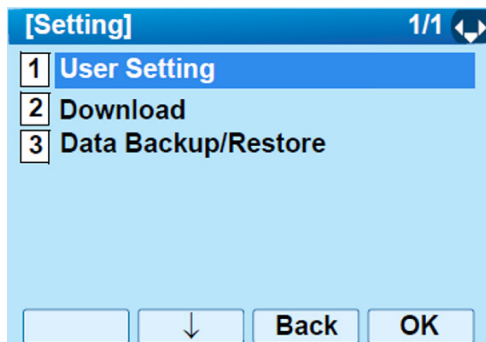
STEP 3: Select **1** **User Setting** then press  (**Enter**),  (**Right-cursor**) or press **1** key.



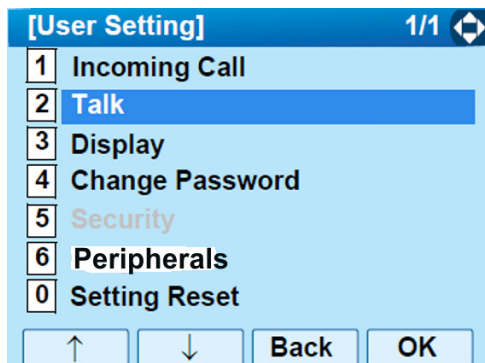

STEP 4: Select **2** **Talk** then press  (**Enter**),  (**Right-cursor**) or press **2** key.

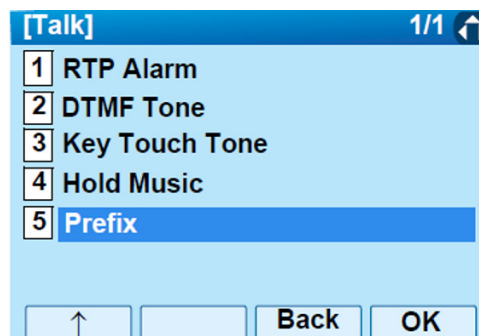

STEP 5: Select **5** **Prefix** then press  (**Enter**),  (**Right-cursor**) or press **5** key.



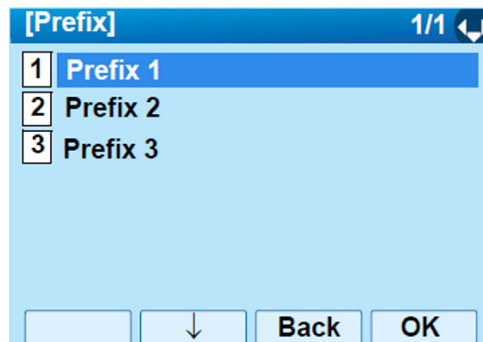

STEP 6: Select **1** **Prefix** then press  (**Enter**),  (**Right-cursor**) or press **1** key.

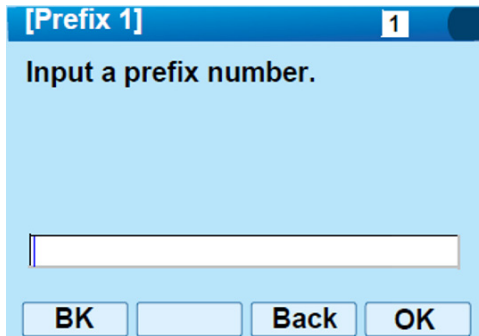

STEP 7: Enter a prefix using the digit keys. After entering the prefix press  (Enter).





STEP 8: The display returns to the Prefix screen. Refer to [STEP 6: on page 118](#). If multiple prefixes need to be set, repeat [STEP 6:](#) and [STEP 7:](#). In that case, select  **Prefix 2** and  **Prefix 3**.



Note: A maximum of 10 digits (0-9, * and #) can be set as a prefix.

Note: When prefix is added, a maximum of 32 digits including the prefix can be sent as a dial number.

To Delete All Data

STEP 1: Press the  key. The menu screen is displayed.

STEP 2: Select **Directory** then press  (Enter) or press  key.

STEP 3: Select  : **DeleteAll** then press  (Enter) or press  key.

1: REGIST	2: SEARCH		
3: SETTING	4: DeleteAll		
1:	2:	3:	4:

The following is a sample display of a deleted number:

**TLBK1: DELETE ALL DATA
INPUT PWD: 4DIGIT**



STEP 4: After 4-digit password is entered, display asks if you want to delete all directory data. To delete, press **Yes**.

STEP 5: After the appropriate directory data is deleted, the following is displayed.

DELETED ALL TELBOOK DATA

To Delete Specific Directory Data

STEP 1: Press the  key. The menu screen is displayed.

STEP 2: Select **Directory** then press  (Enter) or press  key.

STEP 3: Select **2**: **Search** then press  (**Enter**) or press **2** key.

1: REGIST	2: SEARCH		
3: SETTING	4: DeleteAll		
1:	2:	3:	4:

Note: *The display will show No TELBK Data if there are no entries to review.*

TLBK1: SEARCH NAME	[A]
<	
NUM	MENU

STEP 4: Select a search method (e.g., NAME, GRP, NUM or MEM).

[SEARCH MENU]			
NAME	GRP	NUM	MEM

STEP 5: With the cursor key or softkey select the search method to be used.

STEP 6: Select a specific group to be deleted (e.g., Group 01).

1: NEC
2142622000

STEP 7: Select **1: NEC**.

[1]	NEC	
2142622000		
CHG	DEL	Dial

STEP 8: Press the **DEL** softkey to delete the appropriate directory data.

STEP 9: After the appropriate directory data is deleted, the following display appears. Confirm delete by pressing **Yes**.

TLBK1: DELETE DATA
DELETE DATA?
Yes No

STEP 10: The following confirmation message appears.

DELETE COMPLETE!

5. CALL HISTORY OPERATION

This chapter explains Call History of DT730G. By using Call History, you can make a call with simple operation.



Call History allows the telephone to register up to 50 records into its memory. If the number of registered records exceeds 50, a record will be deleted in order of occurrence.

Note: Register Call History data to Personal Directory as necessary. Call History data will be cleared when powering off the telephone. However, Call History data can be backed up to your PC. About Backup/Restore, see [Backup Personal Settings](#) or [Restore Personal Settings](#) in 2.TERMINAL SETUP.

Note: The Call History data that is stored in the memory of each telephone cannot be added to Phonebook (both System Phonebook and Local Phonebook) controlled by the system.

Note: On the Menu screen, use  or \uparrow/\downarrow softkey to move the cursor up/down a line.

To View Call History

- STEP 1: Press the  key. The menu screen is displayed.
- STEP 2: Select **1**: **History** then press  (**Enter**) or press **1** key.
- STEP 3: Display an item from the history by pressing the **CID** softkey.

LIST MENU

Redial CID

- STEP 4: Detailed information of the last call is displayed.



01:	2142622000
\uparrow	\downarrow
2-9	10:42
Store	DEL

Note: Use the Cursor key to display the next/former records.

Note: If no history data is saved, "LIST END" will be displayed on the LCD.

To Make a Call from Call History

Note: While the history data is displayed, you cannot make a call by dialing a telephone number.

- STEP 1: Press the  key. The menu screen is displayed.
- STEP 2: Select **1**: **History** then press  (**Enter**) or press **1** key.
- STEP 3: Press the **Redial** softkey.

LIST MENU

Redial CID

STEP 4: Detailed information of the last call is displayed.

Redial - 01		2142622000	
↑	↓	Store	DEL

STEP 5: Lift the **Handset** or press the  key to dial the displayed number.

Store Call History data to Speed Dial

STEP 1: Display the Call History data of the target telephone number (see Make a Call from History). The following is an example when the history of a call is displayed.

01:	2142622000		
↑	↓	2-9	10:42
		Store	DEL

STEP 2: Press the **Store** softkey while displaying the call history information for the target telephone number. The display changes as follows:

01:	2142622000		
4-28	2:40	Jane Doe	
STA	Abb	TELBK	

STEP 3: Select **STA** to store in a Speed Dial bin or select **Abb** to store in a System Speed Dial bin. Select **TELBK** to store in a Telephone Book.

To Delete Call History Data

STEP 1: Press the  key. The menu screen is displayed.

STEP 2: Select **1**: **History** then press  (**Enter**) or press **1** key.

STEP 3: Display an item from the history by pressing the **CID** softkey.

LIST MENU	
Redial	CID

STEP 4: Detailed information of the last call is displayed.

01:	2142622000		
↑	↓	2-9	10:42
		Store	DEL

STEP 5: Press the **DEL** softkey.

STEP 6: Select **One** to delete a single call or **All** to delete all call histories.

01:	2142622000		
4-28	2:40	Jane Doe	
One	All		

APPENDIX : PHOTO FRAME APPLICATION

The Photo Frame application allows the DT730G LCD to display image files which are loaded from a USB memory or downloaded from a XML server.

Images can be viewed one at a time, or as a slide show.

TIP For details of how to use the Photo Frame application through XML server, contact the System Administrator.

TIP To use the Photo Frame application, configuration setting by System Administrator is required. For details, contact the System Administrator.

Note: *The supported image file is bitmap format only.*

Note: *For (ITL-12DG-3), Photo Frame application is not supported.*

To Launch Photo Frame Application

The following are ways to start the Photo Frame application.

Usage	Procedure
Implemented as an XML application.	Select Service → 2 Photo Frame from the Menu screen.
Used as a screen saver.	An image file of the application appears automatically when the screen saver started.

TIP The launching method of Photo Frame application depends on the configuration setting. For details, contact the System Administrator.

Display Sample and Key Operations

The following shows the display sample and key operations for the Photo Frame application.

Example of full screen display.



TIP When the size of an image file to be displayed is larger than the screen size of an LCD (480 x 272), the image file is partially displayed from the upper-left corner of the LCD.

By the aspect ratio of an image file, some portions of the image file may be displayed in black color. Also, when the size of the image file to be displayed is smaller than the size of an LCD, the relative position of the image file will be displayed in black color.

TIP



Key operations for full screen display.

	Menu/Icon	Description
Soft Keys	Soft Key 1 ~ 3	Not used.
	Soft Key 4 (Photo Frame Setting)	Displays Photo Frame Setting screen.
	Up/Down/Left/Right	Moves the selected focus to the other direction.
	Enter	Not used.

TIP

When an image is displayed as a screen saver in a full screen, the Photo Frame application can be closed by pressing any key, and you can go back to the previous screen before launching Photo Frame application.

• Configuration for Photo Frame Application

By pressing **Soft Key 4** (the soft key on the far right)) while the Photo Frame application is activated, you can configure the setting of Photo Frame application. For details, see [MENU LIST](#)

How to Use the Photo Frame Application Using USB Memory

This section explains how to load images from a USB memory and view them on the Photo Frame application.

Note: *A USB memory with security feature is not available.*

Note: *For format types of USB memory, be sure to use the USB memory which has been formatted as FAT or FAT32.*

Note: *You must connect USB memory to the USB port of the terminal directly.*

Note: *When you save image files of Photo Frame application to the USB memory, the image files must be stored in a folder created (the folder name must be named as **PhotoFrame**) directly beneath the USB memory.*

• How to Launch the Photo Frame Application

STEP 1: Insert USB memory into the USB port of the terminal.



TIP Be sure to confirm the USB Connection icon is displayed on the LCD.

STEP 2: Press **Menu** to display the **Menu** screen, and select **Service**.

Select an item by one of the following operations.

- Highlight an item by using cursor key, and press , or **OK**.
- Press **3**.

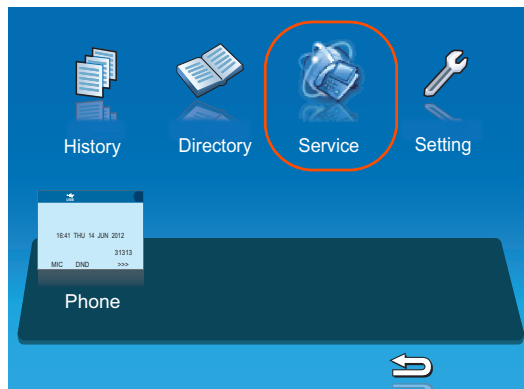

When two or more Service URLs are registered, Service screen appears.

TIP

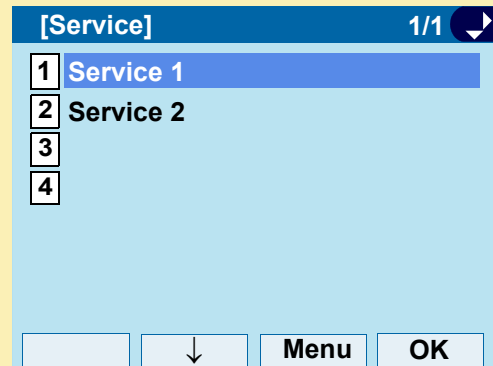
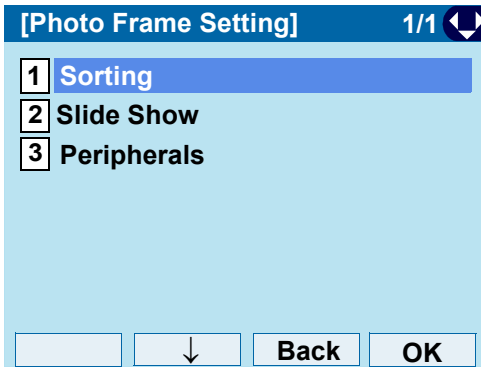

Photo Frame application has been launched.





• Sort Setting

STEP 1: Press **Soft Key 4** (the soft key on the far right) while the Photo Frame application is activated.



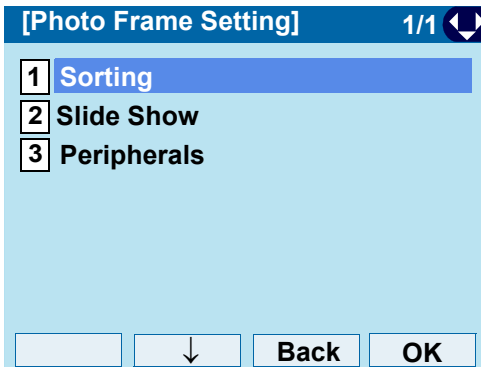

STEP 2: On the **Photo Frame Setting** screen, select **1 Sorting**.
Select an item by one of the following operations.

- Highlight an item by using , and press , or **OK**.
- Press **1**.



STEP 3: Choose **1 File Name**.
Select an item by one of the following operations.

- Highlight an item by using , and press  or **OK**.
- Press **1**, and press  or **OK**.

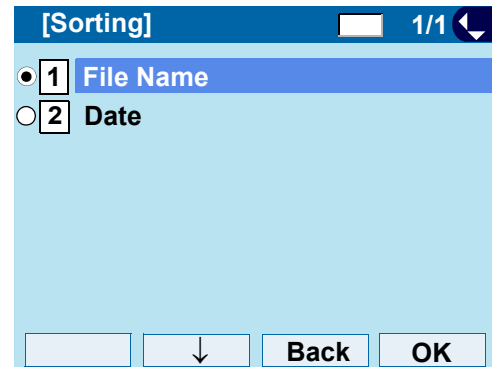

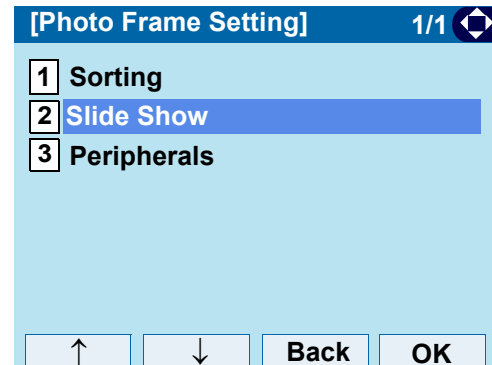

• To Set Slide Show

STEP 1: Press **Soft Key 4** (the soft key on the far right) while the Photo Frame application is activated.



STEP 2: On the **Photo Frame Setting** screen, select **2 Slide Show**.

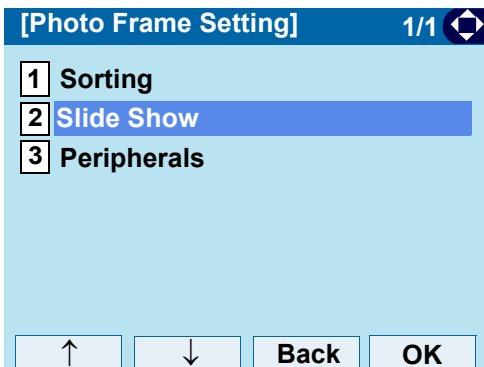

Select an item by one of the following operations.

- Highlight an item by using , and press ,  or **OK**.
- Press **2**.



STEP 4: Choose whether to **Enable/Disable** the Slide Show Mode.

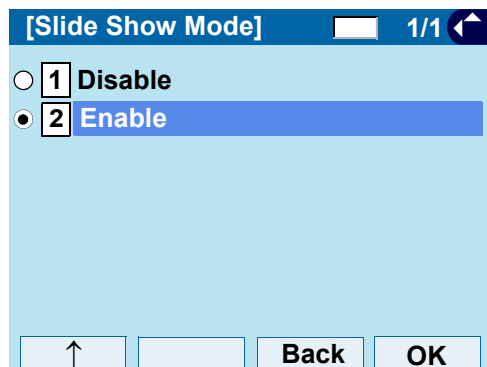

Select an item by one of the following operations.

- Highlight an item by using , and press  or **OK**.
- Press **1** or **2**, and press  or **OK**.



STEP 3: Choose **1 Slide Show Mode**.

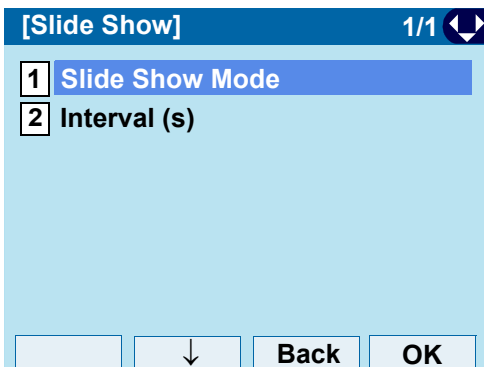

Select an item by one of the following operations.

- Highlight an item by using , and press ,  or **OK**.
- Press **1**.



STEP 5: Choose **2 Interval (s)**

Select an item by one of the following operations.

- Highlight an item by using , and press ,  or **OK**.
- Press **2**.

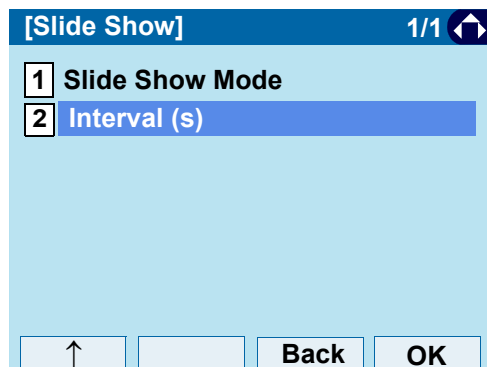

STEP 6: Specify interval time.

Enter the interval time to switch with digit keys, and press  or **OK**.

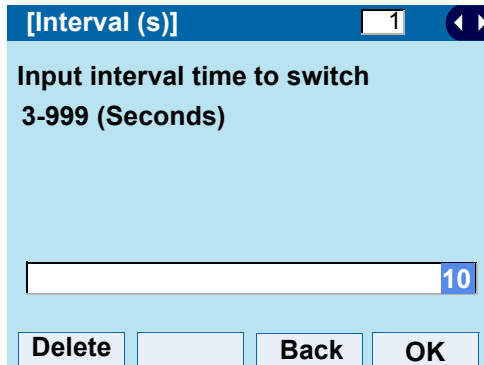

• Remove USB Memory

The following explains how to remove a connected USB memory from the terminal while the Photo Frame application is activated.

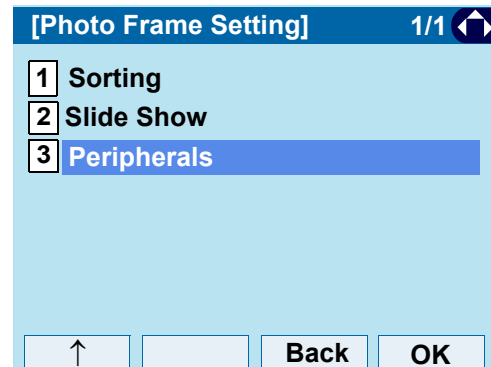

TIP For how to remove the USB memory, you can also refer [Safely Remove USB Device](#).

STEP 1: Press **Soft Key 4** (the soft key on the far right) while the Photo Frame application is activated.





STEP 2: On the **Photo Frame Setting** screen, select **3 Peripherals**.

Select an item by one of the following operations.

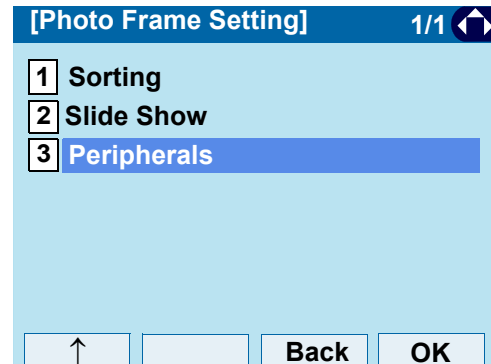
- Highlight an item by using , and press ,  or **OK**.
- Press **3**.



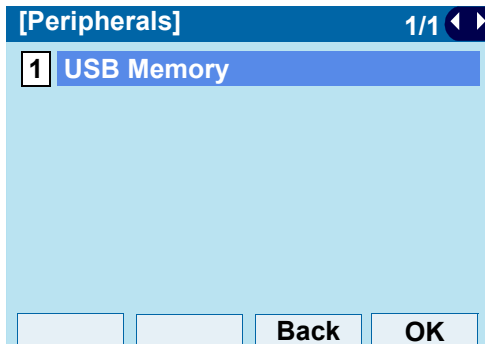

STEP 3: Ensure that **1** **USB Memory** is specified.
Select an item by one of the following operations.

- Highlight an item by using, press ,  or **OK**.
- Press **1**.



STEP 4: Verify that **1** **Remove** is specified.
Select an item by one of the following operations.

- Highlight an item by using, press ,  or **OK**.
- Press **1**.

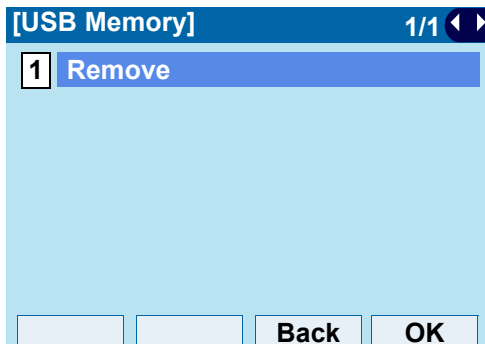

STEP 5: Press  or **OK**.

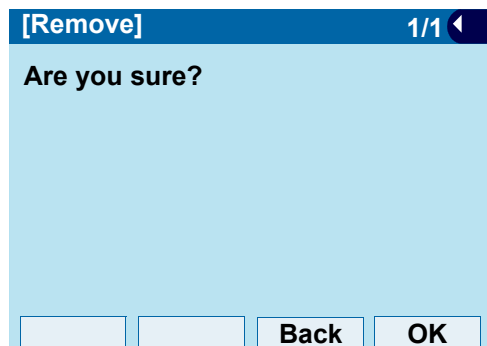

STEP 6: Press  or **OK**.

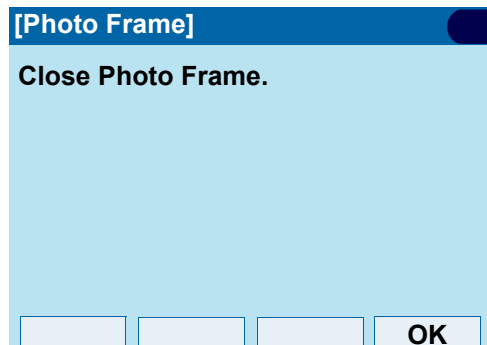

STEP 7: Confirm that the USB icon has disappeared from the screen, and remove the USB device from the terminal.

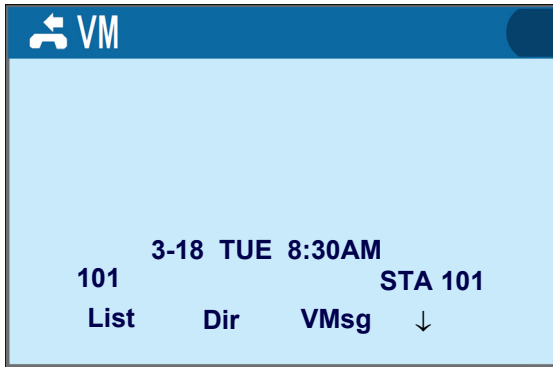

Note: Be sure to confirm that the USB icon () has disappeared from the screen.

Note: When you turn off the power of terminal, be sure to remove the USB memory beforehand.

MENU LIST

Menu List: DT730G (ITL-12CG-3)

Menu Item	Description
Menu	Press  to display the Menu screen.
History	Select this option to view the Call History data. Also, you can add the history data to the directory.
Directory	Select this option to access the directory feature. There are the following three types of directory features: Personal Directory, Phonebook and Corporate Directory. This chapter explains the menu list for Personal Directory feature.
Service	Select this option to display the screen of XML application/Photo Frame application registered in the service URL.
Setting	Select this option to make the user setting of DT730G.
Portal	Select this option to display XML application screen registered in the home URL.

Menu List for **History**

Menu Item	Description	Default Value
History	System history.	–

Menu List for **Directory**

Menu Item	Description	Default Value
Directory	Directory history.	–

Menu List for **Setting**

Menu Item		Description	Default Value
Setting			
1	User Setting	Select this option to configure the user setting of DT730G.	–
	1 Incoming Call	Select this option to set up for incoming calls.	–
	1 Ring Volume	Not used.	–
	2 Offhook Ring	Select this option to specify whether to use the Off-hook ringing.	Enable
	3 Headset Ring	Select this option to specify whether to use the headset ringing.	Disable
	4 Ring Tone	Select a ringer tone for External Call and Internal Call. (Automatic / Tone Type 1~14 / Download 1~3)	Automatic (Tone Type 1)
	5 Illumination	Select this option to set the illumination pattern for External Call and Internal Call. (Automatic / Disable / Red / Green / Blue / Yellow / Purple Light Blue / White / Rotation)	Automatic (Red)
	6 Headset Ring Volume	Not used.	–
	2 Talk	Select this option to set up for telephone conversation.	–
	1 RTP Alarm	Select this option to specify whether to use the RTP alarm.	Automatic
	2 DTMF Tone	Select this option to specify whether to use the DTMF tone.	Automatic
	3 Key Touch Tone	Select this option to set the key touch tone generated when the digit keys are pressed while the telephone is off-hook.	Automatic (Tone)
	4 Hold Music	Select a Music on Hold to be heard by DT730G user.	Default
	5 Prefix	Select this option to register a Prefix number.	–
	3 Display	Select this option to set up for the LCD display.	–
	1 Time Format	Choose between 12-hour or 24-hour clock format.	Automatic (12-hour format)
	2 Local Volume	Specify whether to display the following volume levels: handset receiver volume, speaker volume, ringer tone volume and LCD contrast.	Automatic (Enable)
	3 Screen Saver	Select this option to set up Screen Saver related data.	–

Menu Item		Description	Default Value
	1 Screen Saver Mode	Select this option to specify whether to use a Screen Saver.	Disable
	2 Wait Time	Select this option to specify the Wait Time to launch a Screen Saver.	120 min
	4 Back Light	Select this option to set the brightness of the backlight. 1. Level 1 (Bright) ~ 4. Level 4 (Dark)	Level 2
	5 Font Size	Select this option to change the font size displayed on an LCD.	Standard
	1 Standard		
	2 Small		
	6 Language	Select this option to select a language to be displayed on an LCD.	Automatic
	7 Advanced	Select this option to set up for the following additional data.	–
	1 Wallpaper	Select this option to specify the Home screen background. (default/download)	Default
	2 Shortcut Icon	Not used.	–
	3 Font Color	Select this option to specify the font color for the Time Display/Feature Information Display area. * You can check the color by selecting each color number. (Color 1 ~ Color 16)	Color 2
	4 Turn Off Display	Select this option to specify the data when turning off the display automatically.	–
	1 Turn Off Display Mode	Select this option to set up for Turn Off Display Mode. (Disable/Enable/App Priority)	App Priority
	2 Wait Time	Select this option to specify the time until turning off the display. (1-999 min.)	180 min
	5 Backlight Fade Control	Select this option to specify whether Backlight Fade Control is in service, when turning on/off the backlight of the LCD. (Disable/Enable)	Enable
	4 Change Password	Select this option to change the password to lock/unlock the telephone.	0000
	5 Security	Not used.	–

Menu Item		Description	Default Value
	6 Peripherals	Select this option to setup the usage of the peripheral equipment of DT730G.	–
	1. USB Memory	Select this option when removing a USB memory from the terminal.	
	7 Usability	Select this option to set up for the operation of the Help key while Pop-up window is displayed.	–
	1. Help Key Mode	Select this option to set up for Help Key Mode (1 SubMenu/2 Popup Window).	SubMenu
	0 Setting Reset	Select this option to reset the telephone settings.	–
	2 Download	Set the data required when downloading a file.	–
	1 Download Files	Select this option to download files for Music on Hold, ringer tone, Directory and Wallpaper.	–
	1 Hold Music	Select this option to download a file for Music on Hold.	MOH.wav
	2 Ring Tone	Select this option to download files for ringer tones (Download 1 to 3).	–
	1 Download 1	Select this option to download a file for ringer tone (Download 1).	Melody1.wav
	2 Download 2	Select this option to download a file for ringer tone (Download 2).	Melody2.wav
	3 Download 3	Select this option to download a file for ringer tone (Download 3).	Melody3.wav
	3. Directory	Select this option to download the directory files.	Directory.csv
	4. Wallpaper	Select this option to download a file for Wallpaper.	WallPaper.bmp
	2 Download Address	Select this option to enter an IP address of the FTP/TFTP server.	0.0.0.0
	3 Protocol	Select this option to specify a protocol of the server (either FTP or TFTP).	FTP
	4 FTP Settings	Select this option to set necessary data when using FTP service.	–
	1 User ID	Select this option to enter a user ID for downloading via FTP server.	–
	2 Password	Select this option to enter a password for downloading via FTP server.	–
	3 Folder	Select this option to specify the directory where the downloaded file is stored.	–
	3 Data Backup/Restore	Select this option to set the data required for a file backup/restore.	–
	1 Data Backup	Select this option to specify the file name to be backed up.	PersonalData.tgz
	2 Data Restore	Select this option to specify the file name to be restored.	PersonalData.tgz

Menu Item		Description	Default Value
	3 Server Address	Select this option to enter an IP address of the FTP/TFTP server.	0.0.0.0
	4 Protocol	Select this option to select a protocol of the server (either FTP or TFTP).	FTP
	5 FTP Settings	Select this option to set necessary data when using FTP service.	–
	1 User ID	Select this option to enter a user ID for the data backup via FTP server.	–
	2 Password	Select this option to enter a password for data backup via FTP server.	–
	3 Folder	Select this option to specify the destination directory of FTP server.	–

Setting Menu List for **Photo Frame Application**

Menu Item		Description	Default Value
1. Sorting	File Name	Select this option to view the image files sorted by name in alphabetical order.	File Name
	Date	Select this option to view the image files sorted by date of the last update.	
2. Slide Show	Slide Show Mode	Disable	Select this option whether to use Screen Saver Mode.
		Enable	
	Interval Time	Select this option to specify an interval to switch the image file on LCD automatically.	10
3. Peripherals		Select this option when removing a USB memory from the terminal.	–

Menu List: DT730G (ITL-12DG-3)

Menu Item	Description
Menu	Press  to display the Menu screen.
History	Select this option to view the Call History data. Also, you can add the history data to the directory.
Directory	Select this option to access the directory feature. There are the following three types of directory features: Personal Directory, Phonebook and Corporate Directory. This chapter explains the menu list for Personal Directory feature.
Service	Select this option to display the screen of XML application/Photo Frame application registered in the service URL.
Setting	Select this option to make the user setting of DT730G.
Portal	Select this option to display XML application screen registered in the home URL.

Menu List for **History**

Menu Item	Description	Default Value
History	System history	–

Menu List for **Directory**

Menu Item	Description	Default Value
Directory	Directory history.	–

Menu List for **Setting**

Menu Item		Description	Default Value
Setting			
1	User Setting	Select this option to configure the user setting of DT730G.	–
	1 Incoming Call	Select this option to set up for incoming calls.	–
	1 Ring Volume	Not used.	–
	2 Offhook Ring	Select this option to specify whether to use the Off-hook ringing.	Enable
	3 Headset Ring	Select this option to specify whether to use the headset ringing.	Disable
	4 Ring Tone	Select a ringer tone for External Call and Internal Call. (Automatic / Tone Type 1~14 / Download 1~3)	Automatic (Tone Type 1)
	5 Illumination	Select this option to set the illumination pattern for External Call and Internal Call. (Automatic / Disable / Red / Green / Blue / Yellow / Purple Light Blue / White / Rotation)	Automatic (Red)
	6 Headset Ring Volume	Not used.	–
2	Talk	Select this option to set up for telephone conversation.	–
	1 RTP Alarm	Select this option to specify whether to use the RTP alarm.	Automatic
	2 DTMF Tone	Select this option to specify whether to use the DTMF tone.	Automatic
	3 Key Touch Tone	Select this option to set the key touch tone generated when the digit keys are pressed while the telephone is off-hook.	Automatic (Tone)
	4 Hold Music	Select a Music on Hold to be heard by DT730G user.	Default
	5 Prefix	Select this option to register a Prefix number.	–

Menu Item		Description	Default Value
3	Display	Select this option to set up for the LCD display.	–
1	Time Format	Choose between 12-hour or 24-hour clock format.	Automatic (12-hour format)
2	Local Volume	Specify whether to display the following volume levels: handset receiver volume, speaker volume, ringer tone volume and LCD contrast.	Automatic (Enable)
3	Screen Saver	Select this option to set up Screen Saver related data.	–
1	Screen Saver Mode	Select this option to specify whether to use a Screen Saver.	Disable
2	Wait Time	Select this option to specify the Wait Time to launch a Screen Saver.	120 min
4	Back Light	Select this option to set the brightness of the backlight. (Disable/Enable)	Enable
5	Font Size	Select this option to change the font size displayed on an LCD.	Standard
1	Standard		
2	Small		
6	Language	Select this option to select a language to be displayed on an LCD.	Automatic
7	Advanced	Select this option to set up for the following additional data.	–
5	Backlight Fade Control	Select this option to specify whether Backlight Fade Control is in service, when turning on/off the backlight of the LCD. (Disable/Enable)	Enable
4	Change Password	Select this option to change the password to lock/unlock the telephone.	0000
5	Security	Not used.	–
6	Peripherals	Select this option to setup the usage of the peripheral equipment of DT730G.	–
1.	USB Memory	Select this option when removing a USB memory from the terminal.	
7	Usability	Select this option to set up for the operation of the Help key while Pop-up window is displayed.	–
1.	Help Key Mode	Select this option to set up for Help Key Mode (1 SubMenu/2 Popup Window).	SubMenu
0	Setting Reset	Select this option to reset the telephone settings.	–

Menu Item	Description	Default Value
2 Download	Set the data required when downloading a file.	–
1 Download Files	Select this option to download files for Music on Hold, ringer tone, Directory and Wallpaper.	–
1 Hold Music	Select this option to download a file for Music on Hold.	MOH.wav
2 Ring Tone	Select this option to download files for ringer tones (Download 1 to 3).	–
1 Download 1	Select this option to download a file for ringer tone (Download 1).	Melody1.wav
2 Download 2	Select this option to download a file for ringer tone (Download 2).	Melody2.wav
3 Download 3	Select this option to download a file for ringer tone (Download 3).	Melody3.wav
3. Directory	Select this option to download the directory files.	Directory.csv
4. Wallpaper	Select this option to download a file for Wallpaper.	WallPaper.bmp
2 Download Address	Select this option to enter an IP address of the FTP/TFTP server.	0.0.0.0
3 Protocol	Select this option to specify a protocol of the server (either FTP or TFTP).	FTP
4 FTP Settings	Select this option to set necessary data when using FTP service.	–
1 User ID	Select this option to enter a user ID for downloading via FTP server.	–
2 Password	Select this option to enter a password for downloading via FTP server.	–
3 Folder	Select this option to specify the directory where the downloaded file is stored.	–
3 Data Backup/Restore	Select this option to set the data required for a file backup/restore.	–
1 Data Backup	Select this option to specify the file name to be backed up.	PersonalData.tgz
2 Data Restore	Select this option to specify the file name to be restored.	PersonalData.tgz
3 Server Address	Select this option to enter an IP address of the FTP/TFTP server.	0.0.0.0
4 Protocol	Select this option to select a protocol of the server (either FTP or TFTP).	FTP
5 FTP Settings	Select this option to set necessary data when using FTP service.	–
1 User ID	Select this option to enter a user ID for the data backup via FTP server.	–
2 Password	Select this option to enter a password for data backup via FTP server.	–
3 Folder	Select this option to specify the destination directory of FTP server.	–

This page is for your notes.

WEB PROGRAMMING

Web Programming allows you to configure the terminal settings of DT730G from the PC. A web browser (Internet Explorer, etc.) is used to access Web Programming. It is not necessary to install any special application software onto the PC.

Note: *The DT730G and Web Programming PC need to be connected to the same network. When downloading the files for Music on Hold, Ringer Tone and Directory to the DT730G, FTP (TFTP server) are required on the network. For details on the FTP service, contact to the System Administrator.*

Note: *Terminal settings through Web Programming is available while DT730G is logged into the system.*

PC Requirements for Web Programming

Items		Operating Conditions
Operating System		Microsoft® Windows® XP/Vista/ Windows® 7
CPU		Comply with conditions for use of Microsoft® Windows or Microsoft® Internet Explorer.
Memory		
Browser		Microsoft® Internet Explorer 6.0 or later
Monitor	ITL-12CG-3	4.3 inch Color (16777216 colors) TFT
	ITL-12DG-3	3.8 inch Gray Scale (8 gradations) FSTN
Others		Mouse, LAN connection port (RJ-45)

To Login

Follow the steps below to open the Web Programming.

- STEP 1: Start up Internet browser on the PC.
- STEP 2: Enter **IP address** of the target DT730G on the address toolbar and press **Enter** key.
- STEP 3: The Web Programming Login screen is displayed. Enter a user name (type **USER**) and a password (**Note 1**), then click the **OK** button.

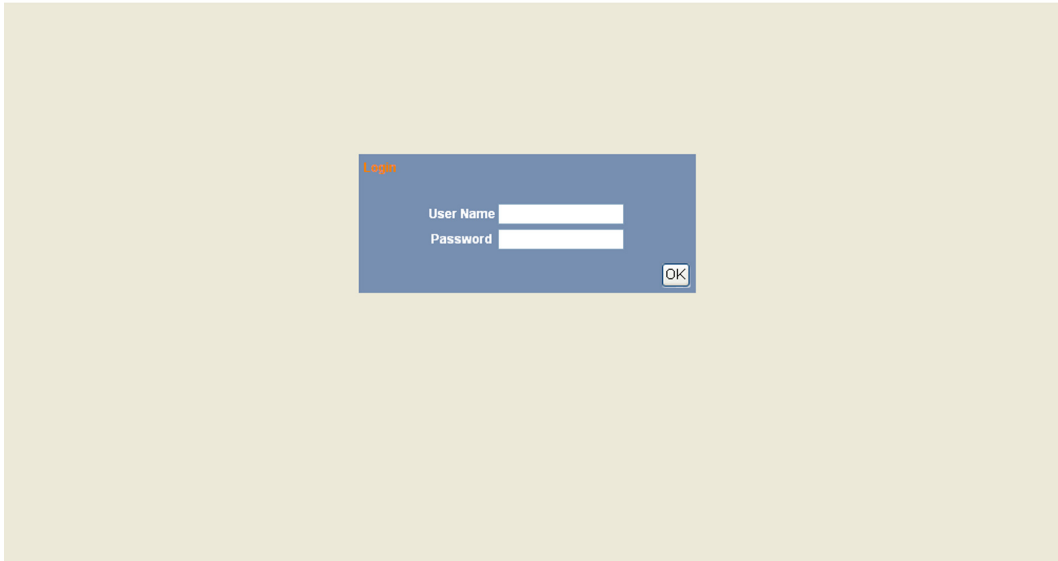

- Note:** Enter the same password used when logging into the DT730G. "0000" is used as the default password
- Note:** For IP address of the DT730G, contact the System Administrator.
- Note:** If the login screen does not appear, check the LAN connection status and entered IP address. If the problem persists, contact the System Administrator.

STEP 4: The Web Programming **Home** screen appears.

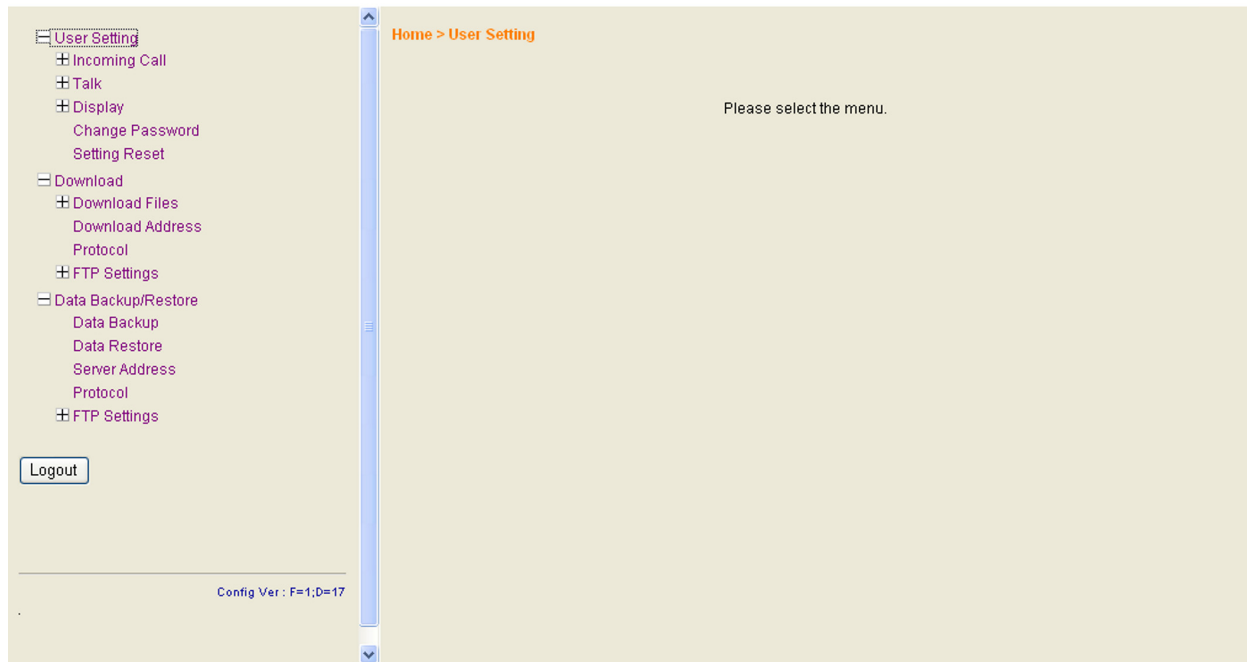

To Logout

Follow the steps below to exit the Web Programming.

STEP 1: Click **Logout** button at the lower left of the screen.

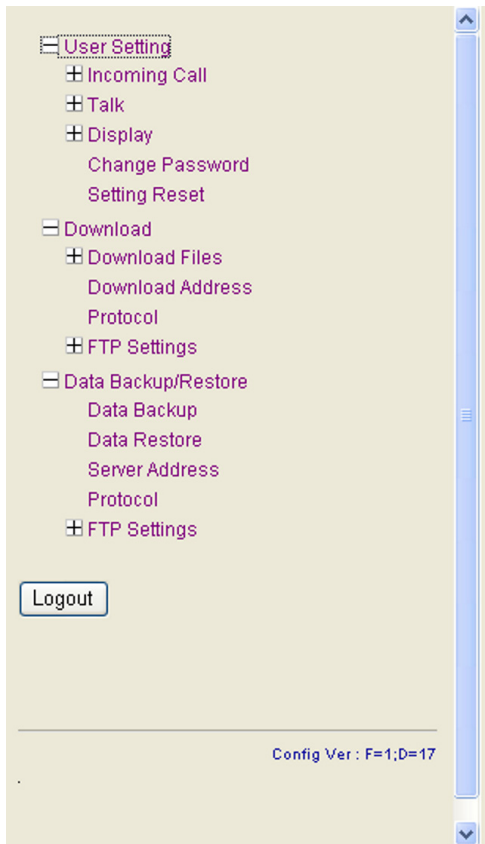

- STEP 2: The confirmation message appears. Click **OK** button to log out of Web Programming.
- STEP 3: The display changes as follows. Click **Back** button.



STEP 4: After the Web Programming Login screen is displayed, close the Internet browser.

- Note:** Make sure to perform the logout operation after the data setting of the telephone.
- Note:** When 15 minutes have passed leaving the PC without operation after log in to Web Programming, the user is forcibly logged out from the Web Programming.

How to Operate

The following explains how to change the ringer tone for external call. Web Programming includes the same menu configuration as "Setting" of DT730G terminal. For details on each menu item, see [Setup With Feature Key](#) in [2.TERMINAL SETUP](#).

- STEP 1: From the Home screen, click **User Setting** → **Incoming Call** → **Ring Tone** → **External Call**.
- STEP 2: Select a desired tone type by clicking the corresponding radio button.
- STEP 3: Click **OK** button to save the change to the database.

STEP 1: Click items to navigate through the menu.

NEC Empowered by Innovation

DT700 Series
Web Programming
Hardware Ver 9.1.3.4
Firmware Ver 0.3.5.0
MAC Address 00:60:89:07:14:57

Home > User Setting > Incoming Call > Ring Tone > External Call

External Call

- 0. Automatic
- 1. Tone Type 1
- 2. Tone Type 2
- 3. Tone Type 3
- 4. Tone Type 4
- 5. Tone Type 5
- 6. Tone Type 6
- 7. Tone Type 7
- 8. Tone Type 8
- 9. Tone Type 9
- 10. Tone Type 10
- 11. Tone Type 11
- 12. Tone Type 12
- 13. Tone Type 13
- 14. Tone Type 14
- 15. Download 1
- 16. Download 2
- 17. Download 3

External Call

Cancel OK

Logout

STEP 2: Click the radio button to select a parameter.

STEP 3: Click OK button to accept the selection.

Click Logout button to exit from the Web Programming.

STEP 4: A confirmation dialog appears. Click **OK** button on the dialog.

This page is for your notes.

UT880 User Guide

NEC Corporation of America
September, 2014