

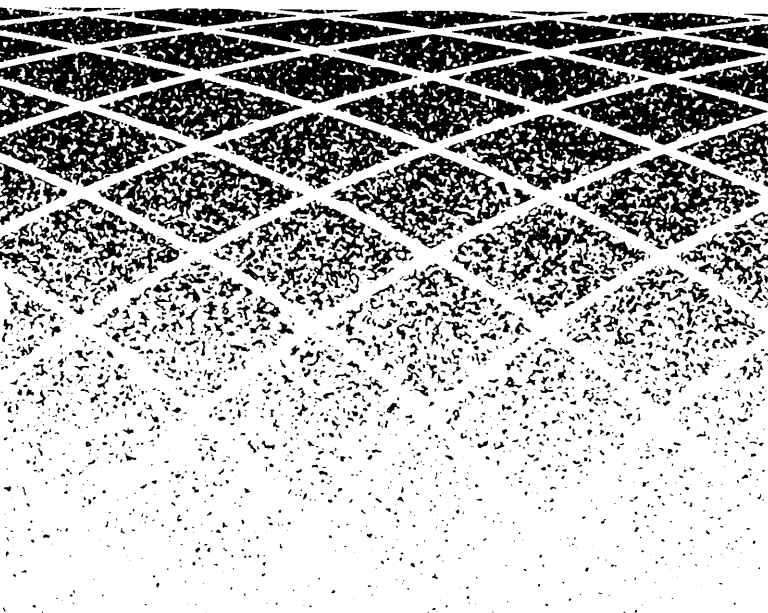

PARTNER® Plus/PARTNER **II**
Communications System

Quick Reference for Use with
MLS-Series Telephones



Copyright © 1994 AT&T
All Rights Reserved
Printed in U.S.A.

518-455-327
Issue 1
August 1994

MLS-34D, MLS-18D, MLS-12D, MLS-12, MLS-6, and PARTNER are registered trademarks of AT&T.

Table of Contents

Telephone Buttons and Indicators	2
RinginG Patterns	4
Lights	4
ProgramminG	5
Dial-Code Features	7
Using the Phone	11
EnterinG a Password	11
EnterinG an Account Code	11
MakinG a Call	11
AnswerinG a Call	12
TransferriG a Call	13
PuttinG a Call on Hold	14
AnswerinG a Call RinginG at Another Extension	14
MakinG a Conference Call	15
JoininG a Call	15
MakinG a Call to a CallinG Group	16
Loudspeaker PagiG	16
Simultaneous PagiG	16
ForwardinG a Call	17
SendinG Calls to a CoverinG Extension	17
SendinG Calls Immediately to Your Voice Mailbox	18
Personal Speed Dial Numbers	Back Cover
System Extensions	Back Cover

Help

If you have problems with your phone, contact your System Manager. If the problem is not solved, in the continental U.S. please call our toll-free Helpline, available 24 hours a day, at 1 800 628-2888.

Outside the continental U.S., contact your AT&T Representative or local Authorized Dealer.

Telephone Buttons and Indicators

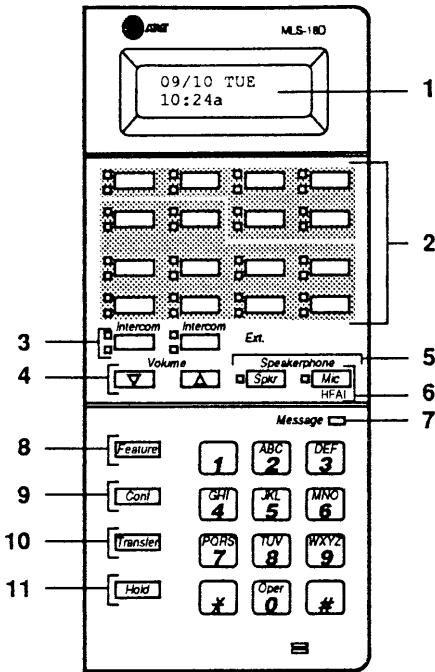

1 Display [MLS-34D,*MLS18D,*and MLS-12D* only]

When dialing, shows the number dialed, duration of call, and feature messages. When receiving an intercom call, shows the number (and name if programmed) of the extension calling. When in programming mode, displays programming messages. When not using the phone, displays today's date and time, or Caller ID information (if available—on PARTNER II system only). (You can adjust the display contrast on the MLS-18D; see "Volume Control Buttons" on page 3.)

2 Line/Pool*/Programmable Buttons

A line or pool can be assigned on any button with status lights. (The MLS-34D and MLS-18D have status lights for all of these buttons; the MLS-12D and MLS-12^e are identical to the MLS-18D, except that they do not have lights for the 6 buttons shown above the white line.) If a line or pool is assigned, press the button to make and receive calls. You may have to enter an account code to get an outside line (see page 7).

If no line or pool is assigned, you can program the button with one-touch dialing features (no status lights are required for most features). Then you can press the button to dial a number or use the feature. Dial-code features are listed on pages 7-10; programming instructions are on page 5. (**NOTE:** *The MLS-6^e phone has 4 line/pool/programmable buttons. If all of the buttons are used for lines or pools, it has no buttons left for dial-code features.*)

* Pool buttons apply only to PARTNER II systems in Hybrid mode.

Telephone Buttons and Indicators

3 Intercom Buttons

Press either button to place an inside (intercom) call to another extension.

4 Volume Control Buttons

Press to decrease (▼) or increase (▲) the volume:

- To adjust ringer volume, press while phone is idle and handset is on the phone.
- To adjust speaker volume, press while listening through the speaker.
- To adjust handset earpiece volume, press while listening to a call through the handset
- To adjust background music volume, press while listening to music through the phone's speaker.

To adjust the display brightness on an MLS-18D phone, when the phone is idle and the handset is on the phone, press [▲]. Then press ▼ to decrease brightness or ▲ to increase brightness.

5 Speakerphone Operation

[MLS-34D, MLS-18D, MLS-12D, and MLS-12 only]

Press [Spkr] to dial and speak on your phone without lifting the handset. When you press [Spkr], both the speaker and the microphone come on (indicated by the lights next to the [Spkr] and [Mic] buttons). When the party on the other end answers, you can speak without lifting the handset. (On the MLS-6, press to dial without lifting the handset; when the party you are calling answers, lift the handset to speak.)

6 Mic (Microphone) Button

[MLS-34D, MLS-18D, MLS-12D, and MLS-12 only]

Press [Mic] to turn your microphone on and off. When the green light next to [Mic] is on, the microphone is on. To answer calls without lifting the handset, leave the microphone on (see "HFAI" below). On a speakerphone call, press [Mic] to mute your voice.

HFAI (Hands-Free Answer on Intercom)

For more convenient speakerphone operation, leave the microphone on all the time (press [Mic] when the phone is not in use). When you receive a voice-sigaled call (you hear a beep), the person calling can talk to you over your phone's speaker; simply begin speaking to have a hands-free, two-way conversation.

7 Message Indicator

Lights when someone signals you using Message Light On (see page 9) or if you have a message in your voice mailbox. To turn off, dial [Feature][1][2] and your extension number, or call the voice messaging system to retrieve then delete your messages.

8 Feature Button

Press to program (page 5) or to use dial-code features (pages 7-10).

9 Conf (Conference) Button

Press to add other parties to your call (page 15).

10 Transfer Button

Press to pass a call to another extension (page 13).

11 Hold Button

Press to put a call on hold for later pickup (page 14).

RinginG Patterns

You can tell the type of call coming in by the way the phone rings:

An Outside Call will *Ring...Ring...Ring...Ring...Ring...Ring...*

An Intercom Call will *Ring-BEEP...Ring-BEEP...Ring-BEEP...*

A Transferred Call will *Ring-BEEP-BEEP...Ring-BEEP-BEEP...*

Lights

Red (top) light shows activity at another extension.

Green (bottom) light shows activity at your extension.

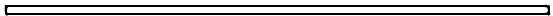

Steady on: Line or pool* is in use.



Off (off continuously): Line or pool* is idle, available for use.

Flash (long on, long off): Call is ringing on the line or in the pool*, or another extension is calling you.

Alternating Red/Green Flash: (red on, green on, red on, green on): Appears at all extensions in a conference or joined call.

Wink (long on, short off): Call is on hold (anyone with the line can retrieve the call).

Green Flutter (short on, short off): Call is on exclusive hold (only extension that put the call on hold can retrieve it), a transferred call is returning to you, or you are being manually signaled by the extension. On PARTNER II systems only, flutter also can mean Caller ID Inspect feature is on or you are receiving a coverage call.

Red Broken Flutter (short on and off followed by long off): Fax trouble.

* Pool buttons apply only to PARTNER II systems in Hybrid mode

To Program Buttons

Use programming to store dialing sequences on programmable buttons (see diagram, page 2). Then simply touch the button to dial automatically.

- 1 Press [*Feature*] [0] [0] to enter programming mode.
- 2 Press a programmable button.
- 3 Press the buttons you normally press to dial another extension, to dial an outside telephone number, or to use a system feature (see examples below).

NOTE: To store [*Intercom*] on a button, press the left [*Intercom*] button.

To program more buttons, or to change the programming, repeat Steps 2 and 3.

- 4 Press [*Feature*] [0] [0] to exit programming mode.

Examples:

Autodial another extension number

To ring extension 11 with one touch, program left [*Intercom*] [1] [1]; to voice signal extension 11, program left [*Intercom*] [★] [1] [1] .

You can also use this button to:

- Transfer calls to the extension with one touch.
- See when the extension is in use (*red steady light*).
- See when the extension is calling you (*green flashing light*).
- See when a call you transferred to the extension is returning to you, the extension is manually signaling you, or (on PARTNER II systems only) when you are receiving a coverage call for the extension (*green fluttering light*).

Autodial an outside telephone number

To dial 555-5678 with one touch, program [5] [5] [5] [5] [6] [7] [8] .

Any dial-code feature on pages 7–10

Program the dial code on a button. For example, to use Do Not Disturb with one touch, program [*Feature*] [0] [1] on a button with lights. For some features, you can also program an extension number or group number on the button, as indicated in the descriptions on pages 7–10. For example, to use Call Pickup for calls ringing at extension 12, program left [*Intercom*] [6] [1] [2] on a button.

Programming

To Program Personal Speed Dial Numbers

- 1 Press [*Feature*] [*Q*] [*Q*] to enter programming mode.
- 2 Press [*Feature*], then a two-digit Dial Code (80–99).
- 3 Enter the phone number. (An outside number can have up to 28 digits.)
To add more Speed Dial numbers, repeat Steps 2 and 3.
- 4 Press [*Feature*] [*Q*] [*Q*] to exit programming mode.

To change a number, follow Steps 1–4 but enter the new number in Step 3.

Special Dialing Functions

You can enter the following special functions in Speed Dial or Auto Dial numbers:

Function	Button	Display	Description
Pause	[<i>Hold</i>]	P	1.5-second pause
Recall	[<i>Spkr</i>]	R	Timed switchhook flash
Stop	[<i>Mic</i>]	S	Stops dialing sequence until button is pressed or code is dialed again
Touch-Tone Enable	[<i>Transfer</i>]	T	Sends touch tones over a rotary line

Dial-Code Features

Feature Description	To Use Manually	To Use Button
Account Code Entry Lets you enter a code of up to 16 digits for an incoming or outgoing call. You may have to enter an account code to access an outside line.	Dial [<i>Feature</i>] [1] [2], the account code, then [<i>Feature</i>] [1] [2] again	☀ Press the button*, dial the account code, then press the button again
Background Music Plays Music On Hold through the speaker on your idle MLS-model phone.	Dial [<i>Feature</i>] [1] [2] to turn on and off	☀ Press the button* to turn on and off
Call Coverage (PARTNER II only) Redirects calls on owned line to another extension for coverage. To cancel, enter your extension as the covering extension. Extension numbers are optional on a button (must be entered manually if not stored).	Dial [<i>Feature</i>] [2] [2] + Your Extension Number + Covering Extension Number	☀ Press the button* + Your Extension Number (if not stored) + Covering Extension Number (if not stored)
Call Forwarding/Call Follow-Me Forwards calls to another extension. To cancel, enter your extension as the destination. Unless Do Not Disturb is on, phone beeps when a call is forwarded. Extension numbers are optional on a button (must be entered manually if not stored).	Dial [<i>Feature</i>] [1] [1] + Your Extension Number + Destination Extension Number	☀ Press the button* + Your Extension Number (if not stored) + Destination Extension Number (if not stored)
Call Pickup Picks up a call ringing at a specific extension. On a programmed button, include extension number.	Dial [<i>Intercom</i>] [6] + Extension Number	Press the button
Caller ID Inspect (PARTNER II only) Shows Caller ID information for another line (without disconnecting a current call or putting it on hold). If a coverage call is ringing, shows the number of the covered extension. To use, program [<i>Feature</i>] [1] [2] on a button with lights (green light flutters when feature is on) .	Not available	☀ Press the button, then press a line, pool**, or intercom button. Press the button again to turn off

* On a button with lights, light is on when feature is on.

** Pool buttons apply only to PARTNER II systems in Hybrid mode.

☀ Feature must be programmed onto a button with lights (see pages 2 and 5).

☀ Button with lights recommended (not required).

Dial-Code Features

Feature Description	To Use Manually	To Use Button
Caller ID Name Display (Partner II only) Switches between caller's phone number and name (if available). To use, program [<i>Feature</i>] [1] [6] on a button with lights (button light is on when name is selected).	Not available	☒ Press the button to turn on and off
Conference Drop Drops the last outside party added to a conference call.	Dial [<i>Feature</i>] [2] [6]	Press the button
Direct Line Pickup—Active Line Accesses a ringing, held, or active call on a line that is not assigned to your phone.	Dial [<i>Intercom</i>] [6] [8] + Line Number	Press the button + Line Number
Direct Line Pickup—Idle Line Accesses an idle line that is not assigned to your phone.	Dial [<i>Intercom</i>] [8] + Line Number	Press the button + Line Number
Do Not Disturb Prevents your incoming calls from ringing (use only if someone covers your calls). To use, program [<i>Feature</i>] [2] [1] on a button with lights. Also provides "Send All Calls" capability: when used with VMS Cover, sends callers directly to your voice mailbox; on PARTNER II only when used with Call Coverage, sends callers directly to the covering extension.	Not available	☒ Press the button to turn on and off
Exclusive Hold Places a call on hold so other extensions cannot retrieve it.	Dial [<i>Feature</i>] [2] [2]	Press the button
Group Calling—Ring/Page Simultaneously rings or pages all extensions in a Calling Group†, or transfers a call to a Calling Group. You are connected to the first group extension that answers.	Ring: Dial [<i>Intercom</i>] [2] + Group Number (1-4) Page: Dial [<i>Intercom</i>] [★] [2] + Group Number (1-4) Transfer: Dial [<i>Transfer</i>] [2] + Group Number (1-4)	Press the button

† If programmed on a button, include the group number (see System Manager for group assignments).

☒ Feature must be programmed onto a button with lights (see pages 2 and 5).

Dial-Code Features

Feature Description	To Use Manually	To Use Button
Group Hunting—Ring/Voice Signal Rings, voice signals, or transfers a call to the next available extension in a Hunt Group. [†]	<i>Ring:</i> Dial [<i>Intercom</i>] [<i>Z</i>] [<i>Z</i>] + Group Number (1-7) <i>Voice Signal:</i> Dial [<i>Intercom</i>] [<i>★</i>] [<i>Z</i>] [<i>Z</i>] + Group Number (1-6) <i>Transfer:</i> Dial [<i>Transfer</i>] [<i>Z</i>] [<i>Z</i>] + Group Number (1-7)	Press the button
Group Pickup Picks up a call ringing at any extension in a Pickup Group. [†]	Dial [<i>Intercom</i>] [<i>4</i>] [<i>4</i>] + Group Number (1-4)	Press the button
Last Number Redial Redials the last outside number you dialed.	Dial [<i>Feature</i>] [<i>0</i>] [<i>5</i>]	Press the button
Loudspeaker Paging Connects you to the loudspeaker paging system.	Dial [<i>Intercom</i>] [<i>Z</i>] [<i>0</i>]	Press the button
Manual Signaling—Ring/Voice Signal When on-hook or on an outside line, beeps an extension; when on intercom, rings or voice signals. Program [<i>Feature</i>] [<i>1</i>] [<i>3</i>] and the extension on a button to ring, or [<i>Feature</i>] [<i>★</i>] [<i>1</i>] [<i>3</i>] and the extension to voice signal. On a button with lights, lights show calling activity.	Not available	★ <i>To beep:</i> Press the button <i>To ring or voice signal:</i> Press [<i>Intercom</i>], then press the button <i>To transfer:</i> Press [<i>Transfer</i>], then press the button
Message Light On/Off Turns phone's message light on or off. Extension number is optional on a button (must be entered manually if not stored).	<i>On:</i> Dial [<i>Feature</i>] [<i>0</i>] [<i>0</i>] + Extension Number <i>Off:</i> Dial [<i>Feature</i>] [<i>1</i>] [<i>0</i>] + Extension Number	Press the button + Extension Number (if not stored)

[†] If programmed on a button, include the group number (see System Manager for group assignments).

★ Button with lights recommended (not required).

Dial-Code Features

Feature Description	To Use Manually	To Use Button
Privacy Prevents others from joining your calls. To use, program [<i>Feature</i>] [0] [2] on a button with lights.	Not available	 Press the button to turn on and off
Recall "Recalls" dial tone when you are on a call, to access a PBX or Central Office service.	Dial [<i>Feature</i>] [0] [3]	Press the button
Save Number Redial Saves the last outside number you dialed into memory (but not a System Speed Dial number). Save a number before you hang up; the number stays in memory until a new one is saved.	Dial [<i>Feature</i>] [0] [4] before hanging up to redial later, dial [<i>Feature</i>] [0] [4] again	Press the button before hanging up to redial later, press the button again
Simultaneous Paging Connects you to the loudspeaker paging system and idle system phones with speakers in Calling Group 1.	Dial [<i>Intercom</i>] [★] [2] [0]	Press the button
Touch-Tone Enable Sets to touch-tone dialing for the rest of a call.	Dial [<i>Feature</i>] [0] [8]	Press the button
VMS Cover Turns voice mail coverage on and off. To use, program [<i>Feature</i>] [1] [5] on a button with lights.	Not available	 Press the button to turn on and off
Voice Interrupt on Busy Talk-Back Lets you respond to a voice interrupt on busy call. To use, program [<i>Feature</i>] [1] [8] on a button with lights.	Not available	 Press the button to turn on and off
Voice Mail Messages Dials the voice messaging system to check messages.	Dial [<i>Intercom</i>] [2] [2] [2]	Press the button
Voice Mailbox Transfer Transfers a call directly to an extension's voice mailbox, so a caller can leave a message.	Dial [<i>Feature</i>] [1] [4] + Extension Number	Press the button + Extension Number

 Feature must be programmed onto a button with lights (see pages 2 and 5).

Using the Phone

[*Hold*] + Password

Entering a Password

- 1 Before lifting the handset or pressing [*Spkr*], press [*Hold*] and enter the four-digit password.

[*Feature*] [1] [2] +
Account Code +
[*Feature*] [1] [2]

Entering an Account Code

- 1 While off-hook, dial [*Feature*] [1] [2].
- 2 Enter an account code of up to 16 digits (manually or using an Auto Dial button or Speed Dial number). See your System Manager for a list of account codes.
- 3 Dial [*Feature*] [1] [2].

Outside:

[*Line*] or [*Pool*] +
Phone Number
or

[*Intercom*] [8] +
Line Number +
Phone Number
or

[*Intercom*] +
Pool Access Code
+ Phone Number

Making a Call

To call an outside party:

If a password is needed, enter it before step 1. Also, to get outside dial tone, you may have to enter an account code before step 2. If this applies to your phone, contact your System Manager for instructions.

You can lift the handset or press [*Spkr*] before dialing.

- 1 If desired, either:
 - Press an idle (not lit) line button. To dial on a line not assigned to your phone, press [*Intercom*] [8] followed by the line number.
 - Press an idle (not lit) pool* button. To access lines in pools not assigned to your phone, press [*Intercom*] followed by the pool access code (880-883).
- 2 Dial telephone number.

To call another extension:

You can lift the handset or press [*Spkr*] before dialing.

Inside—Ringing:

[*Intercom*] +
Extension Number

- 1 Press an idle [*Intercom*] button.
*You hear intercom dial tone, and the light next to the [*Intercom*] button is steady green.*
- 2 To ring the extension, dial the two-digit extension number.

* Pool buttons apply only to PARTNER II systems in Hybrid mode.

Using the Phone

Inside—Voice-Signaled:

[*Intercom*] + [*] +
Extension Number

To voice-signal a system phone at the extension, press [*] plus the two-digit extension number:

- If you hear *one beep*, you have reached an idle system phone. You can speak after the beep. Your voice is heard through the other extension's speaker. If the recipient is present, he or she can reply.
- If you hear *two beeps*, you have reached a busy system phone with Voice Interrupt On Busy assigned. You can speak after the beeps. Be aware that the third party to whom the recipient is speaking will probably also hear the two beeps and the faint sound of your voice. If the recipient has a Voice Interrupt On Busy Talk-Back button, wait for a response.
- If you hear ringing, you have reached an idle standard, MLC-6, MDC 9000, or MDW 9000 phone, or a busy system phone with Voice Interrupt on Busy not assigned. Your call is not completed until someone answers.

Answering a Call

You can answer a call on any line or pool* that is ringing, or select a specific line or pool if more than one is ringing:

- When the telephone is ringing, lift the handset.
- To answer a call on a specific line or in a specific pool, press the button for the line or pool you want to answer, then lift the handset.

If you are already on a call:

- 1 Press [*Hold*] to put the first call on hold.
- 2 Press the line or pool button next to the flashing light to pick up the new call.

To answer a voice-signaled call (your phone beeps):

- 1 If the microphone is on, begin speaking (if not, press [*Mic*] or lift handset).

To respond to a voice interrupt on busy call (you hear two beeps through your phone's handset):

- 1 Press the Voice Interrupt On Busy Talk-Back button, begin speaking, then press the button again.

* Pool buttons apply only to PARTNER II systems in Hybrid mode.

At Your Extension:
[*Line*] or [*Pool*]

[*Hold*] +
[*Line*] or [*Pool*]

Using the Phone

Transferring a Call

To pass a call to another extension:

[Transfer] +
Extension Number
or
[z] [z] + Hunt Group
Number (1-7),
or
[z] + Calling Group
Number (1-4)

- 1 While active on the call, press [Transfer].
The call is put on hold and you hear intercom dial tone.
- 2 Dial the extension number, [z] [z] and a Hunt Group number (1-7), or [z] and a Calling Group number (1-4)*.
- 3 When someone answers, announce the call, then hang up.
If no one answers or the call is refused, press the line or pool button next to the winking green light to reconnect to the caller.

To make a voice-signaled transfer:

[Transfer] + [★] +
Extension Number

- 1 While active on the call, press [Transfer].
The call is put on hold and you hear intercom dial tone.
- 2 Dial [★] and the two-digit extension number:
 - If you hear *one beep*, you have reached an idle system phone. You can speak after the beep.
Your voice is heard through the other extension's speaker. If the call is accepted, hang up. If no one answers or the call is refused, press the line or pool button next to the winking green light to reconnect to the caller.
 - If you hear *two beeps*, you have reached a busy system phone with Voice Interrupt On Busy assigned. You can speak after the beeps. Be aware that the third party to whom the recipient is speaking will probably also hear the two beeps and the faint sound of your voice.
Your voice is heard through the recipient's handset or speaker. If the recipient has a Voice Interrupt On Busy Talk-Back button, wait for a response. To complete the transfer, hang up. If the call is refused, press the line or pool button next to the winking green light to reconnect to the caller.
 - If you hear ringing, you have reached an idle standard, MLC-6, MDC 9000, or MDW 9000 phone, or a busy system phone with Voice Interrupt on Busy not assigned. When someone answers, announce the call, then hang up. If no one answers or the call is refused, press the line or pool button next to the winking green light to reconnect the caller.

* See your System Manager for group assignments.

† Pool buttons apply only to PARTNER II systems in Hybrid mode.

Using the Phone

Putting a Call on Hold

To hold so anyone with the line can retrieve it:

Hold:

[Hold]

1 Press [Hold].

The green light next to the button begins to wink.

To hold so only you can retrieve it (Exclusive Hold):

Exclusive Hold:

[Feature] [0] [2]

1 Press [Feature] [0] [2].

The green light next to the button begins to flutter.

To Pick Up:

[Intercom] or
[Line] or [Pool]

To retrieve a held call:

1 Press the intercom, line, or pool* button next to the winking or fluttering light.

2 Lift handset.

Answering a Call Ringing at Another Extension

To answer a call ringing at any other extension:

At a specific extension:

[Intercom] [6] +

Extension Number
or

At any extension:

[Intercom] [6] [8] +

Line Number

1 Press [Intercom].

2 Lift handset.

3 Dial [6] plus the number of the ringing extension (or if you know which line is ringing—but not the specific extension—dial [6] [8] plus the two-digit line number).

To answer a call ringing at any extension in a Pickup Group†:

At any extension in a Pickup Group:

[Intercom] [6] [6] +
Group Number (1-4)

1 Press [Intercom].

2 Lift handset.

3 Dial [6] [6] plus the group number (1-4).

* Pool buttons apply only to PARTNER II systems in Hybrid mode.

† See your System Manager for group assignments.

Using the Phone

Making a Conference Call

To add parties to a call (max. 4 parties plus you):

Telephone or
Extension Number +
[Conf] + [Line] or
[Pool] or [Intercom] +
Telephone or
Extension Number
+ [Conf]

- 1 Call the first party (can use Speed Dial or Auto Dial buttons).
- 2 After the first party answers, press [Conf].
- 3 Press an idle line or pool* button and call the second party (or press [Intercom] and extension number to add an inside party).
- 4 After the second party answers, press [Conf] again; you are connected with both parties.

The lights at all extensions in the conference flash red and green.

- 5 To add others, repeat steps 2–4.

To drop the last outside party added to the call:

To Drop:
[Feature] [0] [6]

- 1 Press [Feature] [0] [6].

NOTE: *You cannot add more than 2 outside parties, transfer a conference call, join a conference call, or drop the first-added party.*

Joining a Call

To connect yourself to an outside call being conducted at another extension:

[Line]
or
[Intercom] [6] [8]
+ Line Number

- 1 Press the line button next to the steady red light or dial [Intercom] [6] [8] and the two-digit line number.
- 2 Lift handset.

NOTE: *You cannot join an inside call, a conference call, or a call at an extension with Privacy turned on. You cannot join calls using pool buttons.*

* Pool buttons apply only to PARTNER II systems in Hybrid mode.

Using the Phone

Making a Call to a Calling Group

To call everyone in a Calling Group:*

Ringing Call:

[*Intercom*] [*Z*] +
Group Number (1-4)

- 1 Press [*Intercom*].
- 2 Lift handset.
- 3 Dial [*Z*] and a group number (1-4) to ring the group, or dial [*★*] [*Z*] plus a group number to page those in the group who have idle system phones with speakers.

Paging Call:

[*Intercom*] [*★*] [*Z*] +
Group Number (1-4)

You are connected to the first extension to answer.

Loudspeaker Paging

To make an announcement over the loudspeaker paging system (if one is connected to your system):

[*Intercom*] [*Z*] [*Q*]

- 1 Press [*Intercom*].
- 2 Lift handset.
- 3 Dial [*Z*] [*Q*], then follow the instructions for your loudspeaker paging system to make your announcement.

Simultaneous Paging

To make an announcement over the loudspeaker paging system and all idle system phones with speakers in Calling Group 1:

[*Intercom*] [*★*] [*Z*] [*Q*]

- 1 Press [*Intercom*].
- 2 Lift handset.
- 3 Dial [*★*] [*Z*] [*Q*], then follow the instructions for your loudspeaker paging system to make your announcement.

If someone answers the simultaneous page, the page becomes an intercom call.

* See your System Manager for group assignments.

Forwarding a Call

To forward intercom, outside, and transferred calls:

[*Feature*] [1] [1]
+ Your Extension
Number +
Destination
Extension Number

- 1 Press [*Feature*] [1] [1].
- 2 Dial your extension number.
- 3 Dial the destination extension number.

Your phone beeps once each time a call is forwarded from your extension.

To cancel Call Forwarding, follow Steps 1-3 above, but enter your own extension number as the destination extension in Step 3.

Sending Calls to a Covering Extension

On PARTNER II systems only, you may be able to send intercom and transferred calls and outside calls on lines assigned ownership to another extension for coverage*:

[*Feature*] [2] [0]
+ Your Extension
Number + Covering
Extension Number

- 1 Press [*Feature*] [2] [0].
- 2 Dial your extension number.
- 3 Dial the covering extension number.

Calls are routed to the covering extension after the Call Coverage Ring interval set for your system.

- 4 If you want to bypass the Call Coverage Ring interval and send calls to the covering extension as soon as they start to ring, press the Do Not Disturb button.

If you have a voice messaging system and VMS Cover is activated, calls that are not answered at the covering extension go to your voice mailbox.

To cancel Call Coverage, follow Steps 1-3 above, but enter your own extension number as the covering extension in step 3.

* Ask your System Manager if you can use this feature.

Sending Calls Immediately to Your Voice Mailbox

If you have a voice messaging system and VMS Cover is activated, calls are sent to your voice mailbox after the VMS Cover Ring interval set for your system. If you want to bypass the VMS Cover Ring interval and send calls to your mailbox as soon as they start to ring, press the Do Not Disturb button while VMS Cover is on.

Personal Speed Dial Numbers

To dial a Personal Speed Dial number: Press [*Feature*] then the Dial Code.

See page 6 for programming instructions. Your system may also be programmed with System Speed Dial numbers (Dial Codes 600-699), which are similar to Personal Speed Dial numbers except anyone on the system can dial them. If programmed, a list is available from your System Manager.

Record your Personal Speed Dial numbers below, in pencil.

CODE	NAME	CODE	NAME
80		90	
81		91	
82		92	
83		93	
84		94	
85		95	
86		96	
87		97	
88		98	
89		99	

System Extensions

To call the receptionist at extension 10: Dial [*Intercom*] [0] or [*Intercom*] [1] [0].

EXT	NAME	EXT	NAME	EXT	NAME
10		26		42	
11		27		43	
12		28		44	
13		29		45	
14		30		46	
15		31		47	
16		32		48	
17		33		49	
18		34		50	
19		35		51	
20		36		52	
21		37		53	
22		38		54	
23		39		55	
24		40		56	
25		41		57	

* Shading indicates extensions that apply only to the PARTNER II system.