



▶ User Guide for the
Polycom[®] SoundStation[®] IP 6000
Phone

Trademark Information

POLYCOM®, the Polycom “Triangles” logo and the names and marks associated with Polycom’s products are trademarks and/or service marks of Polycom, Inc. and are registered and/or common law marks in the United States and various other countries. All other trademarks are property of their respective owners. No portion hereof may be reproduced or transmitted in any form or by any means, for any purpose other than the recipient’s personal use, without the express written permission of Polycom.

Patent Information

The accompanying product is protected by one or more U.S. and foreign patents and/or pending patent applications held by Polycom, Inc.

Disclaimer

Some countries, states, or provinces do not allow the exclusion or limitation of implied warranties or the limitation of incidental or consequential damages for certain products supplied to consumers, or the limitation of liability for personal injury, so the above limitations and exclusions may be limited in their application to you. When the implied warranties are not allowed to be excluded in their entirety, they will be limited to the duration of the applicable written warranty. This warranty gives you specific legal rights which may vary depending on local law.

Copyright Notice

Portions of the software contained in this product are:

Copyright © 1998, 1999, 2000 Thai Open Source Software Center Ltd. and Clark Cooper

Copyright © 1998 by the Massachusetts Institute of Technology

Copyright © 1998-2003 The OpenSSL Project

Copyright © 1995-1998 Eric Young (eay@cryptsoft.com). All rights reserved

Copyright © 1995-2002 Jean-Loup Gailly and Mark Adler

Copyright © 1996-2004, Daniel Stenberg, <daniel@haxx.se>

Permission is hereby granted, free of charge, to any person obtaining a copy of this software and associated documentation files (the “Software”), to deal in the Software without restriction, including without limitation the rights to use, copy, modify, merge, publish, distribute, sublicense, and/or sell copies of the Software, and to permit persons to whom the Software is furnished to do so, subject to the following conditions:

The above copyright notice and this permission notice shall be included in all copies or substantial portions of the Software.

THE SOFTWARE IS PROVIDED “AS IS”, WITHOUT WARRANTY OF ANY KIND, EXPRESS OR IMPLIED, INCLUDING BUT NOT LIMITED TO THE WARRANTIES OF MERCHANTABILITY, FITNESS FOR A PARTICULAR PURPOSE AND NONINFRINGEMENT. IN NO EVENT SHALL THE AUTHORS OR COPYRIGHT HOLDERS BE LIABLE FOR ANY CLAIM, DAMAGES OR OTHER LIABILITY, WHETHER IN AN ACTION OF CONTRACT, TORT OR OTHERWISE, ARISING FROM, OUT OF OR IN CONNECTION WITH THE SOFTWARE OR THE USE OR OTHER DEALINGS IN THE SOFTWARE.

© 2009 Polycom, Inc. All rights reserved.

Polycom, Inc.

4750 Willow Road

Pleasanton, CA 94588-2708

USA

No part of this document may be reproduced or transmitted in any form or by any means, electronic or mechanical, for any purpose, without the express written permission of Polycom, Inc. Under the law, reproducing includes translating into another language or format.

As between the parties, Polycom, Inc., retains title to and ownership of all proprietary rights with respect to the software contained within its products. The software is protected by United States copyright laws and international treaty provision. Therefore, you must treat the software like any other copyrighted material (e.g., a book or sound recording).

Every effort has been made to ensure that the information in this manual is accurate. Polycom, Inc., is not responsible for printing or clerical errors. Information in this document is subject to change without notice.

About This Guide

Thank you for choosing the Polycom® SoundStation® IP 6000 conference phone. This phone provides multi-person audio conferencing capabilities for medium to large conference rooms within a Session Initiation Protocol (SIP) internet telephony system.

This guide provides everything you need to quickly use your new phone. Verify with your system administrator that the network is prepared for configuring the phone. Also, read the Parts List and the Safety and Compliance section in this guide before you set up and use the phone.

This guide includes regulatory compliance information that your system administrator should review. You can also view this guide at www.polycom.com/voicedocumentation.

Changes to This Guide

Major changes have occurred to [Managing Contacts](#) on page 2-12. The sections related to Corporate Directory have been updated.

Contents

About This Guide	iii
Changes to This Guide	iii
1 Getting Started with Your Phone	1-1
Parts List	1-2
Optional Accessories	1-2
Installing the Phone	1-2
Connecting Network and Power Sources	1-3
Power over Ethernet	1-3
AC Power	1-4
Connecting Optional Extension Microphones	1-5
Registering the Phone	1-5
Before You Use Your Phone	1-6
Features of the Phone	1-6
Understanding Line and Call Icons	1-11
Navigating Menus and Entering Data	1-12
2 Customizing Your Phone	2-1
Configuring Basic Settings	2-2
Updating Preferences	2-2
Updating the Language	2-2
Updating the Time and Date Display	2-3
Updating the Display Contrast	2-5
Updating the Backlight Intensity	2-6
Updating the Ring Tone	2-8
Selecting a Ring Tone	2-8
Setting Distinctive Ring Tones for Contacts	2-9
Adjusting the Speaker and Ringer Volume	2-10
Using Call Lists	2-10
Viewing Call Lists	2-10
Managing Call Lists	2-11
Managing Contacts	2-12
Viewing Your Local Contact Directory	2-13
Accessing Your Corporate Directory	2-13
Enabling Your Phone to Save Corporate Directory Search Results	2-14

Adding Contacts to Your Local Contact Directory	2-14
Adding Contacts Manually	2-15
Adding Contacts from Call Lists	2-17
Adding Contacts to Your Contact Directory from a Corporate Directory	2-18
Searching for Contacts	2-19
Searching for Contacts in Your Local Contact Directory	2-19
Searching for Contacts in Your Corporate Directory	2-20
Updating Contacts in Your Local Contact Directory	2-21
Deleting Contacts from Your Local Contact Directory	2-22
Placing Calls to Contacts	2-23
Managing Incoming Calls	2-24
Distinguishing Calls	2-24
Rejecting Calls	2-24
Diverting Calls	2-25
Understanding Shared Lines	2-26

3 Using the Basic Features of Your Phone 3-1

Placing Calls	3-2
Placing Calls Using Speed Dials	3-3
Answering Calls	3-4
Ending Active Calls	3-4
Muting the Microphone	3-4
Redialing Numbers	3-5
Holding and Resuming Calls	3-5
Hosting Conference Calls	3-6
Setting Up Conferences	3-6
Setting Up a Conference Using the Conference Soft Key	3-7
Setting Up a Conference with an Active Call and a Call on Hold	3-7
Holding and Resuming Conferences	3-8
Splitting Conferences	3-8
Ending Conferences	3-9
Transferring Calls	3-9
Performing a Consultative Transfer	3-9
Performing a Blind Transfer	3-10
Forwarding Calls	3-10
Forwarding Calls Statically	3-11
Forwarding Calls Dynamically	3-13
Using Do Not Disturb	3-13
Managing Speed Dial Entries	3-14
Using Voice Mail	3-16

4 Using the Advanced Features of Your Phone4-1

Handling Multiple Call Appearances 4-1

Using Buddy Lists 4-2

 Updating Presence Settings 4-2

 Selecting Contacts to Monitor 4-3

 Blocking Contacts from Viewing Your Status 4-4

 Using Your Blocked List to Unblock Contacts 4-6

 Monitoring the Status of Contacts in Your Buddy List 4-6

 Integrating with Microsoft Office Live Communications Server 2005 4-7

Using Instant Messaging 4-8

 Managing Instant Messages 4-8

 Sending Instant Messages 4-9

Restarting the Phone 4-10

5 Troubleshooting Your Phone5-1

Installation Configuration 5-2

Power and Startup 5-2

Controls 5-3

Access to Screens and Systems 5-4

Calling 5-5

Displays 5-6

Audio 5-6

Productivity Suite 5-6

Testing Phone Hardware 5-7

Safety Notices Safety Notices-1

IndexIndex-1

End-User License Agreement for Polycom® Software

Getting Started with Your Phone

This chapter provides basic installation instructions and information for obtaining the best performance from your SoundStation IP 6000 conference phone.

The phone is a next-generation phone with a modern industrial design, and the latest advancements in Polycom voice technology.

Some of the key features of the phone include:

- Excellent wideband audio performance
- A console microphone with a range of up to ten feet
- Expansion microphones to accommodate large room sizes
- International language support
- Corporate Directory support

This chapter includes the following topics:

- [Parts List](#) on page 1-2
- [Installing the Phone](#) on page 1-2
- [Registering the Phone](#) on page 1-5
- [Features of the Phone](#) on page 1-6
- [Understanding Line and Call Icons](#) on page 1-11
- [Navigating Menus and Entering Data](#) on page 1-12

To read about how to change the settings on your phone, see [Chapter 2, Customizing Your Phone](#). To read about the phone's basic features, see [Chapter 3, Using the Basic Features of Your Phone](#). To read about more advanced features, see [Chapter 4, Using the Advanced Features of Your Phone](#).

If you require additional information or assistance with your new phone, see your system administrator.

Parts List

The following items are included in your basic SoundStation IP 6000 package:

- SoundStation IP 6000 Conference Phone
- 25-foot Network Cable
- Quick Start Guide

Make sure your phone package contains each item. If any item is missing, see your system administrator.

SoundStation IP 6000 Conference Phone

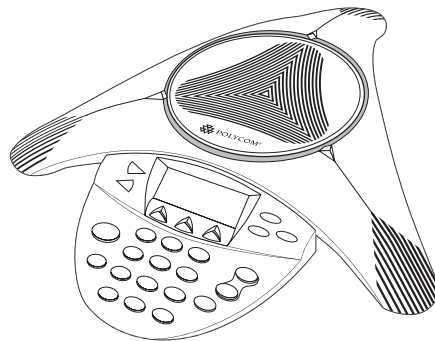

25-foot Network Cable

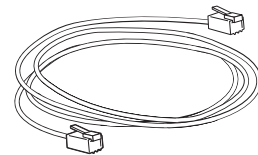

Quick Start Guide



Optional Accessories

The following items are optional accessories for your phone:

- AC Power Kit with:
 - Power Adapter
 - Regional Power Cord
 - Power Insertion Cable
- External Microphone Kit with two extension microphones

Installing the Phone

This section describes how to install your phone. It includes the following topics:

- [Connecting Network and Power Sources](#) on page 1-3.
- [Connecting Optional Extension Microphones](#) on page 1-5.

Connecting Network and Power Sources

There are two ways to connect your phone to the network and a power source. Your system administrator can tell you which of the following methods best suits your teleconferencing needs:

- Power over Ethernet (PoE)
- AC Power

Power over Ethernet

Power over Ethernet is the default connection for your phone.

Note

AC power adapters are not included in the PoE package. If you require one, see your system administrator.

The following figure shows how to connect your phone to the network using a PoE source.

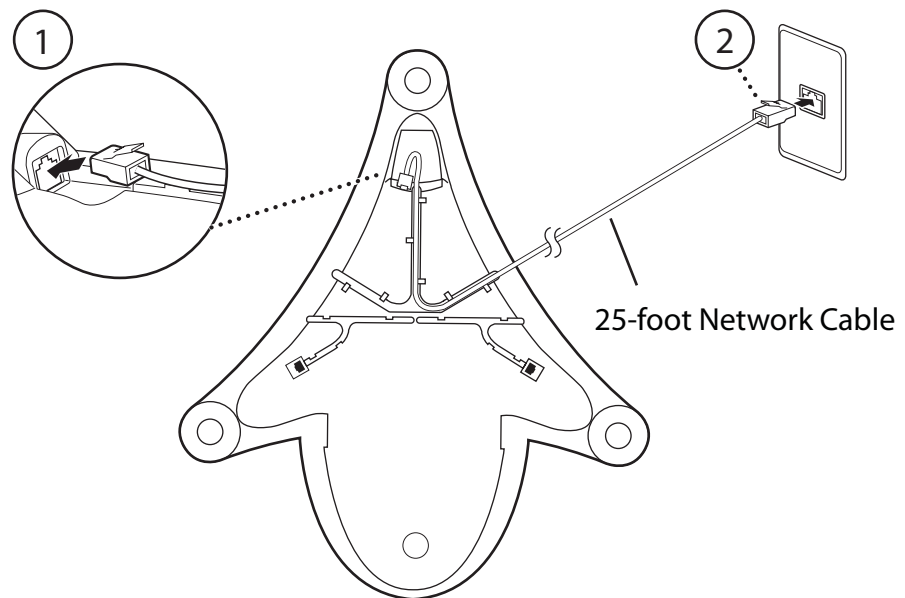

To connect the phone using a PoE source:

1. Connect one end of the 25-foot Network Cable to the LAN jack on the phone.
2. Connect the other end of the 25-foot Network Cable to an available LAN port on the wall or hub/switch device port.

AC Power

To connect your phone to the network using AC power, make sure you have the optional AC Power Kit. The AC Power Kit contains a Power Adapter, Regional Power Cord, and a Power Insertion Cable.

The following figure shows how to connect your phone to the network using optional AC power.

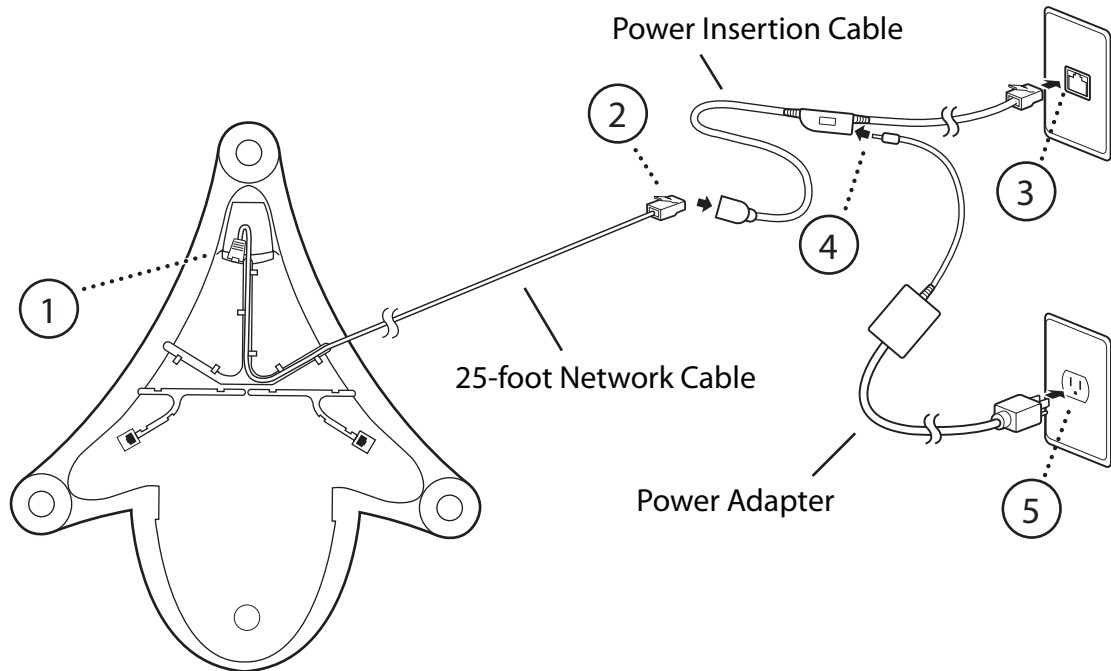

To connect the phone using AC power:

1. Connect one end of the 25-foot Network Cable to the LAN jack on the phone.
2. Connect the other end of the 25-foot Network Cable to the Power Insertion Cable.
3. Connect the Power Insertion Cable to an available LAN port on the wall or hub/switch device port.
4. Connect the Power Adapter to the Power Insertion Cable.
5. Connect the Power Adapter (with the attached Regional Power Cord) to the wall outlet.

Connecting Optional Extension Microphones

To connect extension microphones to your phone, make sure you have the optional External Microphone Kit. The External Microphone Kit contains two extension microphones.

Connect the free end of the optional extension microphone cable to one of the microphone connectors on the phone.

The following figure shows the optional extension microphones connected to the microphone connectors on the phone.

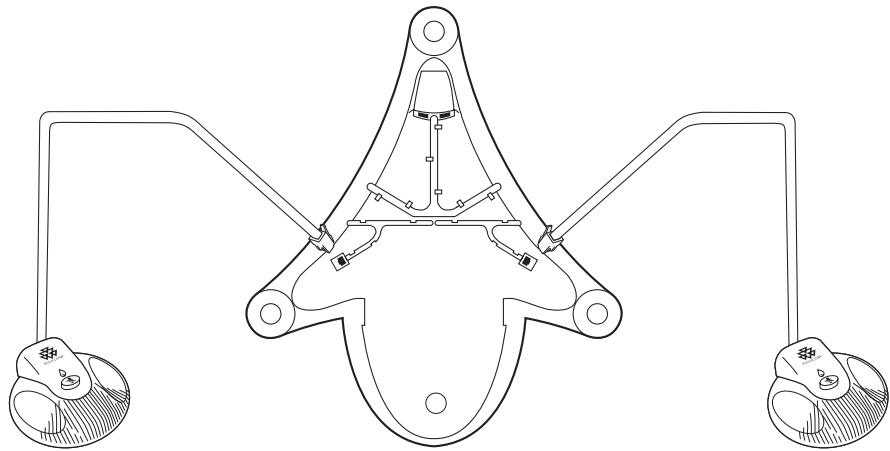

Registering the Phone

Generally, your phone will be deployed with multiple other phones. In this case, your system administrator will configure the phone parameters beforehand, so that after you set up your phone, the phone will be registered and ready to use.

If your phone is not part of a large phone deployment, your phone may not be registered after you set it up. Before you use your phone, you or your system administrator will have to register it.

For detailed information on how to register your phone after you install it, see *Quick Tip 44011: Register Standalone SoundPoint IP, SoundStation IP, and Polycom VVX 1500 Phones*, available at http://www.polycom.com/usa/en/support/voice/soundpoint_ip/VoIP_Technical_Bulletins_pub.html

Before You Use Your Phone

Note

Since you can customize your phone in many different ways, and your system administrator can enable and disable certain features, the user interface that displays on your phone may differ from the figures that appear in this guide.

Before you use your phone, familiarize yourself with the phone's features, the icons that display on the screen, and how to navigate menus and enter data.

Features of the Phone

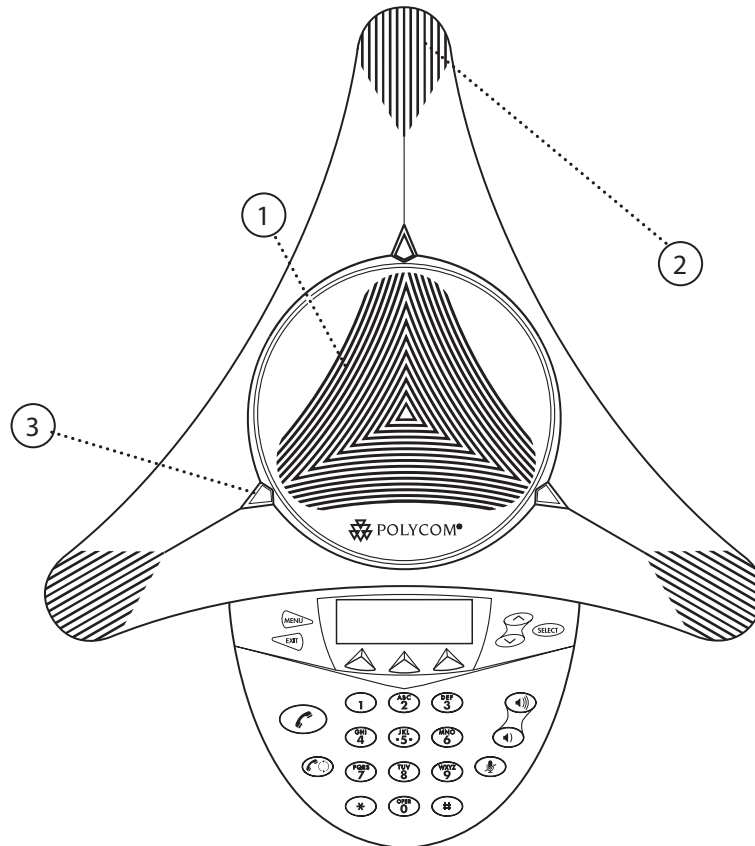

The following figure shows the primary hardware features of your phone console.





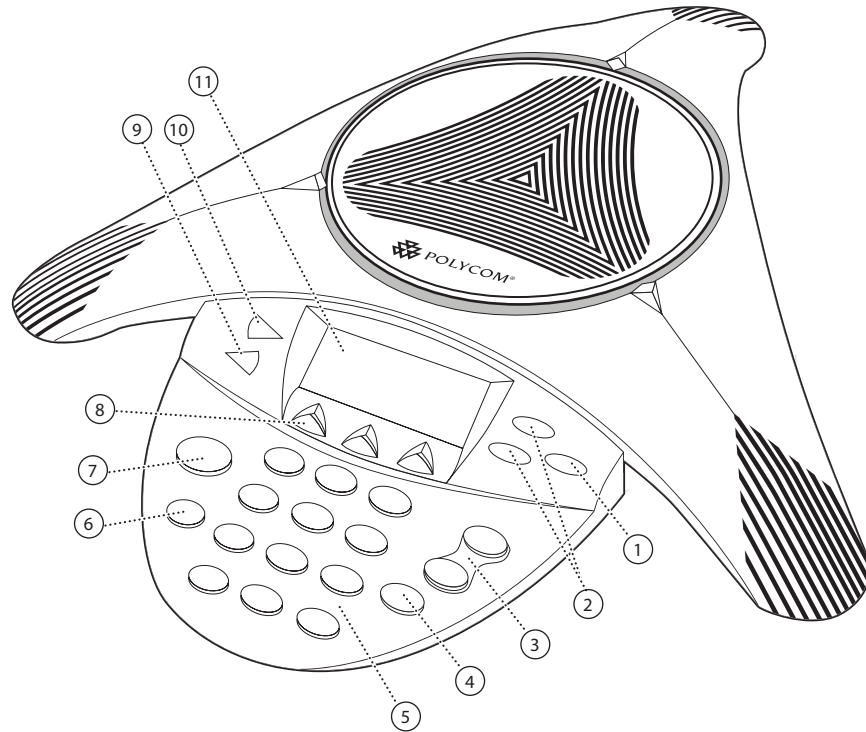



	Feature	Description
1	Speaker	Allows for ringer and hands-free audio output.
2	Microphones	Provide 360° coverage by three internal microphones.
3	LED Indicators	Indicate phone and call status through three bi-color LEDs. The LEDs illuminate to indicate the following normal operational states: <ul style="list-style-type: none">• Solid red—A muted call• Flashing red—A call is on hold• Solid green—A dial-tone is available, dialing is in-progress, or a call is in-progress• Flashing green—An incoming call

The following figure shows the primary key buttons, controls, and indicators on your phone console:















	Item	Description
1	Select key 	Allows you to: <ul style="list-style-type: none"> • Select a field of displayed data • Toggle features on or off
2	Scroll keys 	Allow you to: <ul style="list-style-type: none"> • Scroll through displayed information • Enable or disable fields From the idle screen, the scroll keys also allow you to: <ul style="list-style-type: none"> • View speed dial information (Up scroll key) • View missed calls (Down scroll key)
3	Volume keys 	Adjust the volume of the speaker and the ringer.

	Item	Description
4	Mute key 	Toggles the microphone on or off during a conversation by doing the following: <ul style="list-style-type: none">• Stopping local audio from being heard at the far end of the call• Allowing local audio to be heard at the far end of the call
5	Dial pad keys	Contain 10 digits, 26 alphabetic characters, and other special characters available in context-sensitive applications.
6	Redial key 	Automatically dials the last number you called.
7	Call key 	Initiates or ends a call.
8	Soft keys 	Select specific context-sensitive functions that display on the screen above each soft key.

	Item	Description
9	Exit key 	Exits the current screen and returns to the previous menu.
10	Menu key 	Allows you to: <ul style="list-style-type: none"> • Access additional features and configuration settings • Exit the current screen and return to the idle screen
11	LCD graphic display	Shows the time and date, menus, and soft keys, as well as information about calls, messages, and features. The information display line (the line that displays the directory number) also displays icons and text, such as: <ul style="list-style-type: none"> • Popup text (like network error messages) • Do Not Disturb text/icon (e.g., “Do Not Disturb”) • Call forwarding text/icon (e.g., “Call Forwarding Enabled”) • Missed call text (like “4 new missed calls”) • Presence text (like “Busy”) • Prompt text (like “Enter URL”) • Time and date text If there are multiple items to display, the items will display in a scrolling fashion.

Understanding Line and Call Icons

Icon	Line or Call State	Description
	Active call using Polycom® HD Voice™ technology	A call is in progress using Polycom HD Voice. The active call icons merge into one icon on the phone screen. The following figure shows what displays on the screen during an active call: <div style="text-align: center; margin: 10px 0;">  </div>
	Active call not using Polycom HD Voice	A call is in progress that does not use Polycom HD Voice.
	Conference	A conference is in progress. See Hosting Conference Calls on page 3-6.
	Dialing	The phone is dialing a number.
	Do Not Disturb	You have enabled the Do Not Disturb feature on your phone. Your phone will not ring. See Using Do Not Disturb on page 3-13.
	Forwarding	You have enabled the forwarding feature on your phone. See Forwarding Calls on page 3-10.
	Hold	A call or conference is on hold. See Holding and Resuming Calls on page 3-5 and Holding and Resuming Conferences on page 3-8.
	Registered line	The phone can place and receive calls.
	Registered shared line	The phone, which shares a directory number with another phone, can place and receive calls. See Understanding Shared Lines on page 2-26.







Icon	Line or Call State	Description
	Ringing	The phone is ringing.
	Unregistered Line	The phone is unable to place and receive calls.
	Voice mail message	You have a new voice mail message. See Using Voice Mail on page 3-16.



Navigating Menus and Entering Data

To navigate menus and enter data, follow these tips:

Note

After 20 seconds of inactivity, the menu system automatically exits to the idle screen unless an edit session is in progress.

If you want to...	Then do this...
Enter the main menu	Press  .
Exit the main menu and return to the idle screen	Press  .
Return to the previous menu	Press  . In some cases, you can press the Back soft key to return to the previous menu.
Scroll through menu items	Use  . When lists appear on more than one page, you can press the * key to Page Up, or press the # key to Page Down.
Scroll through lists or fields	Use  or the Next and Prev soft keys.
Select a menu item	Do one of the following: <ul style="list-style-type: none"> Scroll to the menu item, and then press . or Press the dial pad key that corresponds to the item in the numbered menu list. For example, to select the second item in a menu, press 2.

If you want to...	Then do this...
Enter text	Press the dial pad keys one or more times. For example, to enter 'A,' press 2 . To enter 'C,' press 222 .
Enter numbers, uppercase characters, or lowercase characters	Press the 1/A/a soft key one or more times to select numerical, uppercase, or lowercase mode, and then press the dial pad keys one or more times.
Enter special characters	Do the following: <ul style="list-style-type: none"> • Press the * and # keys one or more times. • Press the 1/A/a soft key to select uppercase or lowercase mode, and then press the 1 or 0 keys one or more times.
Enter text in a specific language	Press the Encoding soft key. When in text entry mode, the language the text will display in appears at the top of the screen.
Enter a space	Press the 0 key three times quickly.
Delete text you entered	Press the << soft key.
View additional soft keys	Press the More soft key.
Enable or disable fields	Use  or the Change soft key.
Enable or disable menu items	Press  .

Customizing Your Phone

You can customize your SoundStation IP 6000 conference phone by adjusting certain settings, including language, volume, time and date, display contrast, backlight intensity, and ring type. You can also add contacts to the phone's local Contact Directory.

This chapter shows you how to customize your phone. It includes the following topics:

- [Configuring Basic Settings](#) on page 2-2
- [Adjusting the Speaker and Ringer Volume](#) on page 2-10
- [Using Call Lists](#) on page 2-10
- [Managing Contacts](#) on page 2-12
- [Managing Incoming Calls](#) on page 2-24
- [Understanding Shared Lines](#) on page 2-26

Some customizations, including shared lines and viewing a Corporate Directory, must be set up by your system administrator.

To learn about your phone's basic features, see Chapter 3, [Using the Basic Features of Your Phone](#). To read about the phone's advanced features, see Chapter 4, [Using the Advanced Features of Your Phone](#).

For more information or assistance with your new phone, see your system administrator.

Configuring Basic Settings

To configure basic phone settings, press , and then select **Settings > Basic** to view the basic phone settings you can customize.

This section includes the following topics:

- [Updating Preferences](#)
- [Updating the Display Contrast](#)
- [Updating the Backlight Intensity](#)
- [Updating the Ring Tone](#)

Updating Preferences

The Preferences menu allows you to customize the language that displays on your phone and to specify how the time and date display on the idle screen. You can also enable your phone to save Corporate Directory search results, if Corporate Directory is set up on your phone (see [Searching for Contacts in Your Corporate Directory](#) on page 2-20).

Updating the Language



The phone supports many languages. English (Internal) is the default language that displays.

To change the language:

1. Press , and then select **Settings > Basic > Preferences > Language**.

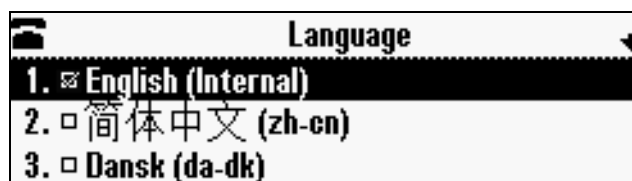
The Language screen displays.



2. Scroll to the language you want, and then press .
The text on the screen changes to the language that you selected.
3. Press  to return to the idle screen.

Updating the Time and Date Display

The time and date appear on the idle screen of your phone. If the phone cannot obtain a time and date, the display will flash. If this happens, or if the time or date is incorrect, see your system administrator.

You can select from various formats for the time and date display, including whether the time or date displays first (clock order). You can also turn the time and date display off, so the time and date does not display on the idle screen. Select and set options that are right for you.

The following figure shows the default format for the date and time display on the phone screen.

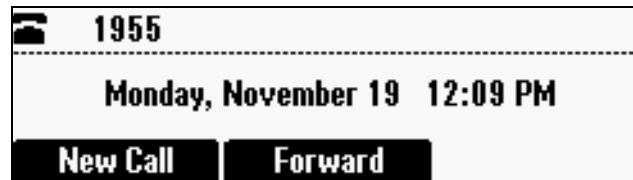



To update the time and date display:

1. Press , and then select **Settings > Basic > Preferences > Time and Date**.

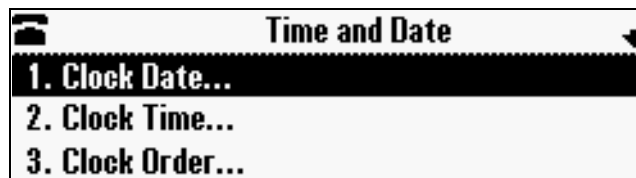
The Time and Date screen displays.



2. Do one of the following:
 - To change the date format, press .
 - or
 - To change the time format, scroll to **Clock Time**, and then press .

The Clock Date screen or the Clock Time screen displays.

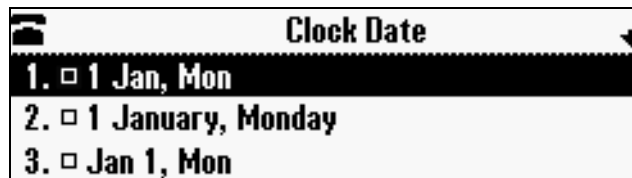

or



3. Scroll to the date or time format you want, and then press **SELECT**.
4. Press **MENU** to return to the idle screen.

To change the order of the time and date display:

1. Press **MENU**, and then select **Settings > Basic > Preferences > Time and Date > Clock Order**.

The Clock Order screen displays.



2. Scroll to the clock order you want, and then press **SELECT**. The default setting is date before time.
3. Press **MENU** to return to the idle screen.

To enable or disable the time and date display:

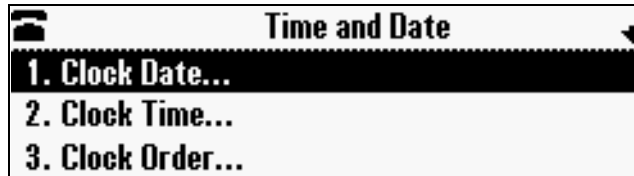

1. Press , and then select **Settings > Basic > Preferences > Time and Date**.

The Time and Date screen displays.

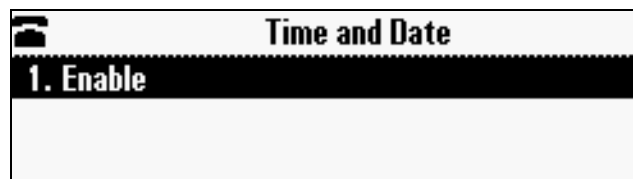

2. Do one of the following:
 - To disable the time and date display, scroll to **Disable**.
 or
 - To enable the time and date display, you do not have to highlight an item. Enable is already highlighted. Go to step 3.



3. Press .
4. Press  to return to the idle screen.

Updating the Display Contrast

You can set how light or dark the screen appears.

To adjust the contrast on the phone screen:

1. Press , and then select **Settings > Basic > Contrast**.

The Contrast screen displays.

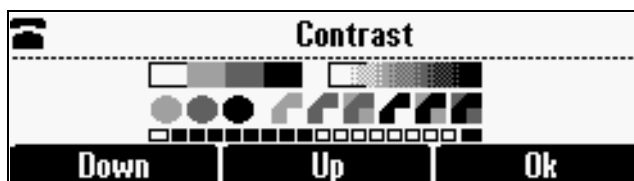

2. Press the **Up** or **Down** soft keys to increase or decrease the display contrast.
3. Press the **Ok** soft key.
4. Press  to return to the idle screen.

Updating the Backlight Intensity

Backlight intensity on the phone has three components:

- Backlight On
- Backlight Idle
- Maximum Intensity

You can modify the Backlight On intensity and the Backlight Idle intensity separately. You can select high, medium, low, and off levels for both.

When you modify the Maximum Intensity, you modify the entire backlight intensity scale. For example, if you decrease the Maximum Intensity, the low, medium, and high levels for both Backlight On and Backlight Idle intensities decrease.

The Backlight On intensity applies to the following events:

- Any key press
- Incoming calls
- Ending a call, holding a call, resuming a call by the other party
- A voice message received

If you do not press any keys on the phone, after 20 seconds of the backlight turning on, the backlight dims (or changes) to medium in the following cases:

- A call is in progress
- A call is on hold
- There is an incoming call (ringing)
- There is an outgoing call (ringing back)
- Any menu shows on the display

In all other cases, the Backlight Idle intensity applies.

To change the backlight intensity:

1. Press , and then select **Settings > Basic > Backlight Intensity**.



The Backlight Intensity screen displays.



2. Select **Backlight On Intensity**.



The Backlight On Intensity screen displays.



3. Scroll to the intensity you want, and then press . The default Backlight On Intensity is High.
4. If you selected a new intensity, press the **Save** soft key. If you did not select a new intensity, press .
5. Select **Backlight Idle Intensity**.

The Backlight Idle Intensity screen displays.



6. Scroll to the intensity you want, and then press . The default Backlight Idle Intensity is Low.
7. If you selected a new intensity, press the **Save** soft key. If you did not select a new intensity, press .

8. Select **Maximum Intensity**.

The Maximum Intensity screen displays.

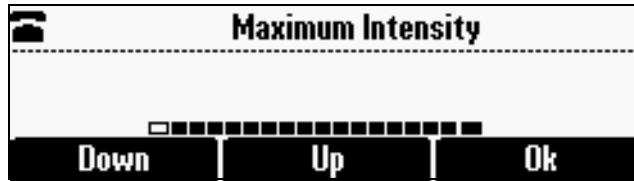

9. Press the **Up** or **Down** soft keys to increase or decrease the maximum intensity the screen can display.
10. If you selected a new intensity, press the **Ok** soft key. If you did not select a new intensity, press **EXIT**.
11. Press **MENU** to return to the idle screen.

Updating the Ring Tone

You can select from many different ring tones to distinguish your phone from your neighbor's. You can also set distinctive ring tones for contacts in your local directory so you can identify callers when your phone rings.

Selecting a Ring Tone

You can choose a unique ring tone for your phone to identify it when it rings.

To select a different ring tone:

1. Press **MENU**, and then select **Settings > Basic > Ring Type**.

The Ring Type screen displays.



2. Scroll to the ring type you want. To hear the ring type before you select it, press the **Play** soft key. The default ring type is Low Trill.
3. To select the ring type, press **SELECT**.
4. Press **MENU** to return to the idle screen.

Setting Distinctive Ring Tones for Contacts

Note

Your company's settings may override this feature. For more information, contact your system administrator.

You can set a distinctive ring tone for each contact in your Contact Directory so you can distinguish callers.

To set a distinctive ring tone for a local contact:

1. Press , and then select **Features > Contact Directory**.

The Directory screen displays.



2. Scroll to the contact for whom you want to assign a distinctive ring tone.
3. Press the **Edit** soft key.

The Edit Contact screen displays.



4. Use the **Next** soft key to scroll to **Ring Type**, and then enter a number corresponding to one of the ring types available.

If a ring type is already assigned to the contact, but you want to change it, press the << soft key to delete the existing ring type. Then, enter a number corresponding to one of the ring types available.



Note

To exit this screen and determine the number associated with a ring type, press the **Menu** key twice, and then select **Settings > Basic > Ring Type**. Each ring type has a number associated with it.



5. Press the **Save** soft key.
6. Press  to return to the idle screen.

Adjusting the Speaker and Ringer Volume

To adjust the speaker volume:

>> During a call, press either  or .

To adjust the ringer volume:

>> When the phone is in the idle state, press either  or .

Using Call Lists

Your phone maintains lists of missed, received and placed calls. Each list can hold up to 100 entries.

If you miss a call, the idle screen will display a message indicating the number of missed calls you have. To view information about the missed call, view your Missed Calls list (see [Viewing Call Lists](#) on page 2-10). After you view the Missed Calls list, the message on the idle screen is removed.

The following figure shows what the idle screen looks like when you miss a call.

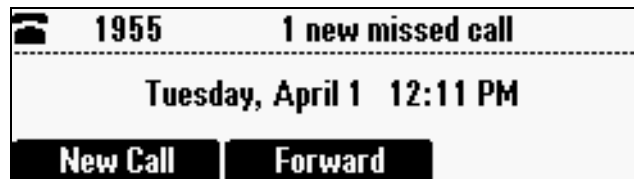

Viewing Call Lists

You can access any call list from the Call Lists menu, or you can quickly access missed calls from the idle screen.

To view a call list:

>> Do one of the following:

- Press , and then select **Features > Call Lists > Missed Calls, Received Calls, or Placed Calls.**

or

- To quickly view the missed calls list, press  from the idle screen.

Managing Call Lists

You can clear all the records in a call list, or just one record. You can also choose a record in a list and return the call, store the call details in your local Contact Directory, or view detailed information about the particular call.

To manage a call list:

1. Press **MENU**, and then select **Features > Call Lists**.

The Call Lists screen displays.

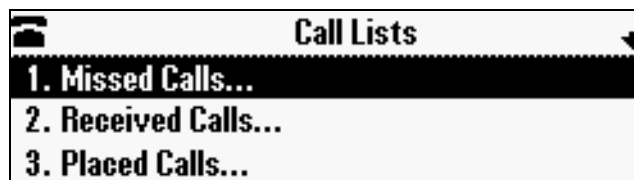

2. Do one of the following:
 - To clear the records in a call list, select **Clear**, and then scroll to either **Missed Calls**, **Received Calls** or **Placed Calls**. Then, press **SELECT**.

The following figure shows the message that displays when you clear a Missed Calls list.

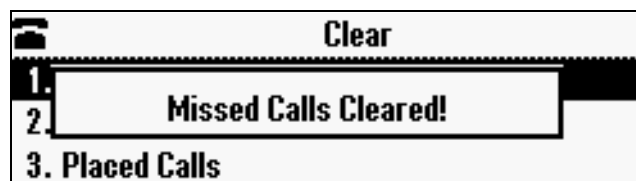

Note

To manually clear all calls in all call lists, restart the phone. See [Restarting the Phone](#) on page 4-10.

or

- To view and manage a call list, scroll to either **Missed Calls**, **Received Calls**, or **Placed Calls**, and then press **SELECT**. The call list information displays.

The following figure shows a Placed Calls list.

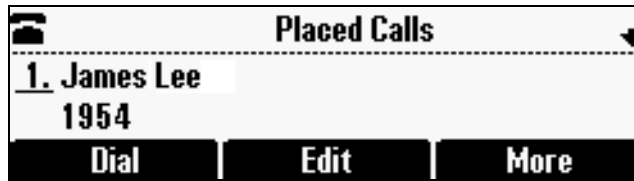

To manage your call list (press the **More** soft key to view all these options):

- To return the call, press the **Dial** soft key.
- To edit the phone number (if necessary) before you dial the number or store the call details in your Contact Directory, press the **Edit** soft key.
- To remove the call from the list, press the **Clear** soft key.
- To store the contact in your Contact Directory, press the **Save** soft key.
- To view information about the call, such as the phone number, the time and duration of the call, and the name of the caller, press the **Info** soft key.

3. Press  to return to the idle screen.

Managing Contacts

You can store a large number of contacts in your phone's local Contact Directory. Contact your system administrator for the exact number.

You can dial and search for contacts in this directory. You may be able to add, edit, and delete contacts. Contact your system administrator to see if you have read-only access to your local Contact Directory, or if you can update it.

If your system administrator sets up Corporate Directory on your phone, you may also have read access to portions of your Corporate Directory. Your system administrator determines which contacts you can see. You can search for contacts in the Corporate Directory, and add contacts from the Corporate Directory to your local Contact Directory. For more information, see [Searching for Contacts in Your Corporate Directory](#) on page 2-20 and [Adding Contacts to Your Contact Directory from a Corporate Directory](#) on page 2-18.

Note

You cannot update the contacts in your Corporate Directory. You can only search for and dial contacts, and add contacts from your Corporate Directory to your local Contact Directory.

Viewing Your Local Contact Directory

To view your local Contact Directory:

>> Press , and then select **Features > Contact Directory**.

The Directory screen displays, listing all the contacts in your directory. Scroll to view all your contacts. You can use the # key to Page Down, and the * key to Page Up.



Accessing Your Corporate Directory

When you access Corporate Directory, a search screen displays so you can search for a specific contact. You can perform a quick search or an advanced search.

Note

Each time you access Corporate Directory, the search screen displays, unless you enable your phone to remember the last search you performed or the last person you selected. To enable this feature, see [Enabling Your Phone to Save Corporate Directory Search Results](#) on page 2-14.

To access your Corporate Directory:

1. Press , and then select **Features > Corporate Directory**.

The Corporate Directory search screen displays.

Note

If you have enabled your phone to save the results of your last search (or remember the last contact you selected), your previous search results (or the contact), will display instead of a blank search screen. To enable this feature, see [Enabling Your Phone to Save Corporate Directory Search Results](#) on page 2-14.

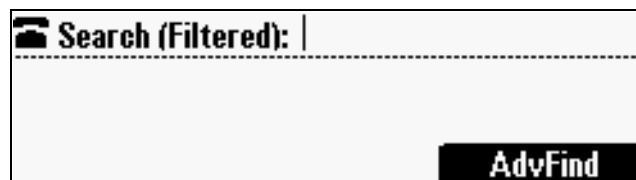





2. Search for the contact. (See [Searching for Contacts in Your Corporate Directory](#) on page 2-20.)

Enabling Your Phone to Save Corporate Directory Search Results

You can enable your phone to save Corporate Directory search results, and to remember the last person you viewed in the directory. Whenever you re-display Corporate Directory, the results of your last search, or the last person you selected, will display. If you don't enable your phone to save search results, each time you access Corporate Directory, a blank search screen will display.

To enable your phone to save Corporate Directory search results:

1. Press , and then select **Settings > Basic > Preferences > Corporate Directory > View Persistency**.
2. Scroll to **Enabled**, and then press .
3. Press .
4. Press  to return to the idle screen.

Adding Contacts to Your Local Contact Directory

You can add contacts to your local Contact Directory in the following ways:

- Manually (if you have permission to update your local Contact Directory)
- From a call list
- From a Corporate Directory (if this is set up on your phone)

Note

You cannot update Corporate Directory from your phone.

Adding Contacts Manually

You can update your local Contact Directory manually, instead of importing contact information from a call list or a Corporate Directory.

To add a contact manually:

1. Press , and then select **Features > Contact Directory**.

The Directory screen displays.



2. To add a contact to your phone's database, press the **Add** soft key.

The Add To Directory screen displays.

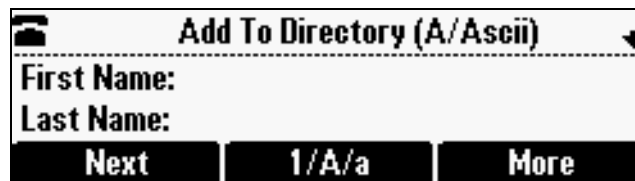

3. Enter the contact information. To move between fields, use the **Next** and **Prev** soft keys. Enter the following information:

Note

Your phone may not display all the following fields. For more information, see your system administrator.

- (Optional.) Enter the First Name and Last Name of the contact. (To enter the contact's name, see [Navigating Menus and Entering Data](#) on page 1-12.)
You can enter a maximum of 32 characters.
- (Required.) Enter the Contact phone number.
You can enter a maximum of 32 characters. The phone number must be unique, and must not already exist in the directory. If you save an entry with a non-unique phone number, the entry will not be saved.
- (Optional.) Update the Speed Dial Index number.
The speed dial index number is automatically assigned to the next available index value, up to a maximum value of 99. You can assign any unused speed dial index number from 1 to 99.

If you assign a speed dial index number that is already taken, the message “Speed dial index already exists” displays. If you enter an invalid speed dial index number (for example, 0 or 00), the message “Speed dial index is invalid” displays.

For more information on speed dial index numbers, see [Managing Speed Dial Entries](#) on page 3-14.

- (Optional.) Enter a Label for the contact. You can enter a maximum of 32 symbols, letters, or numbers.

If you specify a label, the label will be the first item that displays for the contact in the Contact Directory and on the Speed Dial Info screen (before the contact’s first and last names, if specified). For example, in the following figures, Ann Brown has been assigned the label “Sales.”

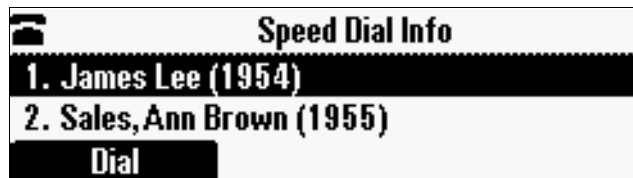

- (Optional.) Set the Ring Type.
For information on setting the ring type, see [Updating the Ring Tone](#) on page 2-8.

- (Optional.) Assign a Divert Contact.
The Divert Contact identifies the third party to which you want this contact’s calls sent. You can enter a maximum of 32 characters.

- (Optional.) Change the Auto Reject and Auto Divert settings.
If you set the Auto Reject field to enabled, each time the contact calls, the call will be directed to your voice mail system (if a voice mail system is set up). If you set the Auto Divert field to enabled, each time the contact calls, the call will be directed to a third party you specify in the Divert Contact field.

Use the scroll keys or the **Change** soft key to switch between the Enabled and Disabled settings for the Auto Reject and Auto Divert fields.

Note

If you do not have a voice mail system set up, enabling the Auto Reject field will have no effect. Each time the contact calls, your phone will ring (unless you choose to divert the contact’s calls, or enable call forwarding or Do Not Disturb on your phone).

- (Optional.) Change the Watch Buddy and Block Buddy settings.

If you set the Watch Buddy field to enabled, you can monitor the contact's status. If you set the Block Buddy field to enabled, the contact cannot monitor your status. For more information on monitoring status, see [Using Buddy Lists](#) on page 4-2.



Use the scroll keys or the **Change** soft key to switch between the Enabled and Disabled settings for the Watch Buddy and Block Buddy fields.

4. Press the **Save** soft key.
5. Press  to return to the idle screen.

Adding Contacts from Call Lists

You can save call information from a call list to your local Contact Directory.

To add a contact to the local Contact Directory from a call list:

1. Do one of the following:
 - To select a call list, press , and then select **Features > Call Lists > Missed Calls, Received Calls, or Placed Calls**.
 - or
 - To quickly see a list of missed calls, press  from the idle screen.
2. Scroll to the contact's call.
3. To save the contact to your Contact Directory, press the **Save** soft key.

The following figure shows the message that displays when you save a contact to your Contact Directory.



If the contact already exists in your Contact Directory, "Contact already exists" displays.

4. Press  to return to the idle screen.

Note

You may want to go to the Contact Directory to see if the contact was saved correctly and to add any missing contact information. To view your Contact Directory, see [Managing Contacts](#) on page 2-12. To update missing contact information, see [Adding Contacts Manually](#) (step 3) on page 2-15.

Adding Contacts to Your Contact Directory from a Corporate Directory

You can save any contact listed in your Corporate Directory (if it is set up on your phone) to your local Contact Directory.

To add a contact to your Contact Directory from a Corporate Directory:

1. Press , and then select **Features > Corporate Directory**.

The Corporate Directory search screen displays.

Note

If you have enabled your phone to save the results of your last search (or remember the last contact you selected), your previous search results (or the contact), will display instead of a blank search screen. To enable this feature, see [Enabling Your Phone to Save Corporate Directory Search Results](#) on page 2-14.

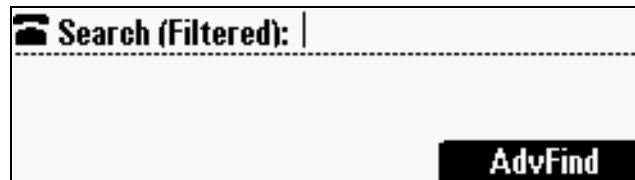

2. Search for the contact, or scroll to the contact's entry.

For information on how to search for a contact, see [Searching for Contacts in Your Corporate Directory](#) on page 2-20.

3. Press the **View** soft key.

The Contact screen displays.

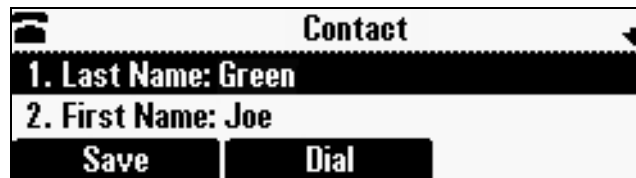

4. To save the contact to the local Contact Directory, press the **Save** soft key.

"Saved" displays on the screen. Only the first name, last name, and phone number are saved.

If the contact already exists in your local Contact Directory, "Contact already exists" displays.

5. Press  to return to the idle screen.

Note

You may want to go to the Contact Directory to see if the contact was saved correctly and to add additional contact information. To view your Contact Directory, see [Managing Contacts](#) on page 2-12. To update contact information, see [Adding Contacts Manually](#) (step 3) on page 2-15.

Searching for Contacts

You can search for contacts in your local Contact Directory, or in a Corporate Directory (if this is set up on your phone).

Searching for Contacts in Your Local Contact Directory

Search for a contact by scrolling through the directory, or entering specific search criteria.

To search for a contact in the local Contact Directory:

1. Press , and then select **Features > Contact Directory**.

The Directory screen displays.



2. Press the **Search** soft key. Then, enter the first few characters of the contact's first or last name, and then press the **Search** soft key again.

The Directory Search screen displays a list of successful matches.



3. Scroll to the contact you are searching for.
You can dial, edit, or delete the contact.
4. Press  to return to the idle screen.

Searching for Contacts in Your Corporate Directory

Search for a contact by entering specific search criteria.

Note

You can enable your phone to save Corporate Directory search results, and to remember the last person you viewed in the directory. Whenever you re-display Corporate Directory, the last search you performed will display, or the last person you selected will display. To enable this feature, see [Enabling Your Phone to Save Corporate Directory Search Results](#) on page 2-14.

To search for a contact in the Corporate Directory:

1. Press , and then select **Features > Corporate Directory**.

The Corporate Directory search screen displays.

Note

If you have enabled your phone to save the results of your last search (or remember the last contact you selected), your previous search results (or the contact), will display instead of a blank search screen. To enable this feature, see [Enabling Your Phone to Save Corporate Directory Search Results](#) on page 2-14.

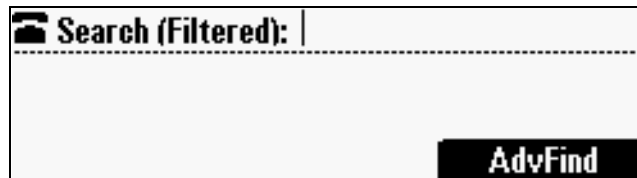

2. Perform a quick search or an advanced search.

A quick search allows you to search using the contact's last name (if the directory is alphabetized by last name) or first name (if the directory is alphabetized by first name). An advanced search uses any combination of the contact's first and last names, phone numbers, address, and title.

Do one of the following:

- To perform a quick search, next to "**Search (Filtered),**" enter the first few characters of the contact's first or last name (depending on how the directory is organized), and then press the **Submit** soft key. The screen displays a list of contacts, starting with any successful matches.

or

- To perform an advanced search, press the **AdvFind** soft key.

The Advanced Find screen displays.



Enter your search criteria, and then press the **Submit** soft key. The screen displays any successful matches.

Note

If you want to erase all your search criteria and enter new criteria before you submit your search, press the **Clear** soft key.

3. Press  to return to the idle screen.

Updating Contacts in Your Local Contact Directory

You can update contact information for contacts in your local Contact Directory. You cannot update information for contacts in your Corporate Directory.

To update a contact in your local Contact Directory:

1. Press , and then select **Features > Contact Directory**.

The Directory screen displays.



2. Scroll to the contact whose information you want to update, or search for the contact (see [Searching for Contacts in Your Local Contact Directory](#) on page 2-19).

To scroll through a list of contacts, use the * key to Page Up and the # key to Page Down.

3. Press the **Edit** soft key.

The Edit Contact screen displays.



4. Update the contact information. Use the **Next** and **Prev** soft keys to scroll between fields.

For information on the fields you can update, see [Adding Contacts Manually](#) (step 3) on page 2-15.

5. Press the **Save** soft key.
6. Press  to return to the idle screen.

Deleting Contacts from Your Local Contact Directory

You can delete contacts from your local Contact Directory, but not from your Corporate Directory.

To delete a contact from the local Contact Directory:

1. Press , and then select **Features > Contact Directory**.

The Directory screen displays.



2. Scroll to the contact you want to delete. Or, search for the contact (see [Searching for Contacts in Your Local Contact Directory](#) on page 2-19).

To scroll through a list of contacts, use the * key to Page Up and the # key to Page Down.

3. Press the **Delete** soft key.
The contact is deleted from the directory.
4. Press  to return to the idle screen.

Placing Calls to Contacts

You can place calls to contacts from your local Contact Directory or from your Corporate Directory (if this is set up on your phone).

To place a call to a contact in the local Contact Directory:

1. Press , and then select **Features > Contact Directory**.

The Directory screen displays.



2. Scroll to the contact you want to call. Or, search for the contact (see [Searching for Contacts in Your Local Contact Directory](#) on page 2-19).

To scroll through a list of contacts, use the * key to Page Up and the # key to Page Down.

3. Press the **Dial** soft key.

To place a call to a contact in the Corporate Directory:

1. Press , and then select **Features > Corporate Directory**.

The Corporate Directory search screen displays.

Note

If you have enabled your phone to save the results of your last search (or remember the last contact you selected), your previous search results (or the contact), will display instead of a blank search screen. To enable this feature, see [Enabling Your Phone to Save Corporate Directory Search Results](#) on page 2-14.

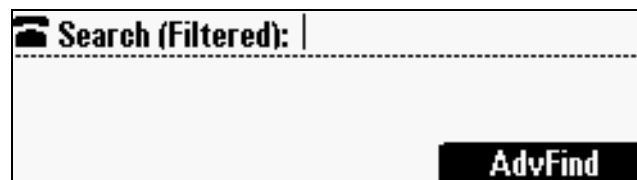

2. Scroll to the contact you want to call. Or, search for the contact (see [Searching for Contacts in Your Corporate Directory](#) on page 2-20).

To scroll through a list of contacts, use the * key to Page Up and the # key to Page Down.

3. Press the **Dial** soft key.

Managing Incoming Calls

You can manage incoming calls from the contacts in your Contact Directory by doing the following:

- Setting up a distinctive ring tone for a contact.
- Rejecting calls from a particular contact by sending the call to your voice mail system. (If you do not have a voice mail system set up, the call will still ring on your phone.)
- Diverting calls from a particular contact to another party.

Distinguishing Calls

You can customize your phone so that you can distinguish callers by certain ring tones. For information on setting a distinctive ring tone for a particular contact, see [Setting Distinctive Ring Tones for Contacts](#) on page 2-9.

Rejecting Calls

You can customize your phone so that incoming calls from a particular party are immediately sent to your voice mail system. (If you do not have a voice mail system set up, the call will still ring on your phone.)

Note

Rejecting calls is not available on shared lines.

To send incoming calls from a particular contact directly to voice mail:

1. Press , and then select **Features > Contact Directory**.

The Directory screen displays.



2. Scroll to the contact. Or, search for the contact (see [Searching for Contacts in Your Local Contact Directory](#) on page 2-19).

To scroll through a list of contacts, use the * key to Page Up and the # key to Page Down.

3. Press the **Edit** soft key.

The Edit Contact screen displays.



4. Use the **Next** soft key to scroll to the **Auto Reject** field, and then change the Auto Reject setting to **Enabled**. Use the scroll keys or the **Change** soft key to select Enabled.
5. Press the **Save** soft key.
6. Press  to return to the idle screen.

Diverting Calls

You can customize your phone so that incoming calls from a particular party are transferred directly to a third party.

To divert incoming calls from a contact to a third party:

1. Press , and then select **Features > Contact Directory**.

The Directory screen displays.



2. Scroll to the contact for whom you want to transfer calls. Or, search for the contact (see [Searching for Contacts](#) on page 2-19).

To scroll through a list of contacts, use the * key to Page Up and the # key to Page Down.

3. Press the **Edit** soft key.

The Edit Contact screen displays.



4. Use the **Next** soft key to scroll to the **Divert Contact** field, and then enter the number of the party to whom you want to divert the call.
You can enter a maximum of 32 characters.
5. Use the **Next** soft key to scroll to the **Auto Divert** field, and then change the Auto Divert setting to **Enabled**. Use the scroll keys or the **Change** soft key to select Enabled.
6. Press the **Save** soft key.
7. Press  to return to the idle screen.

Understanding Shared Lines

Note

Shared lines is an optional feature that your system administrator sets up. Your system may not support it. For more information, contact your system administrator.

If two phones share a line, an incoming call to one number will cause both phones to ring. The call can be answered by either phone, but not both. If your phone shares a line, a shared line icon that is half black and half grey displays on the screen.

The following figure shows the shared line icon at the top left of the screen.



The shared line icon changes to a moving icon, and the console's LEDs glow a steady red, when the line is in use remotely.

Calls on shared lines can be transferred, put on hold, or added to a conference. You cannot forward or reject calls on shared lines.

For information on answering calls with shared lines, see [Answering Calls](#) on page 3-4.

Using the Basic Features of Your Phone

Your SoundStation IP 6000 conference phone is designed to be used like a regular conference phone on a public switched telephone network (PSTN). You can place calls, transfer a call to someone else, conduct a multi-party conference call, or perform other basic and more advanced functions.

At any time, only one active call may be in progress on your phone. The active call is the one that has audio associated with it. In addition to an active call, your phone can handle up to seven other calls, including conference calls, on hold. Your phone can handle a total of eight calls at one time.

This chapter provides introductory information and basic operating instructions for the phone. It includes the following topics:

- [Placing Calls](#) on page 3-2
- [Answering Calls](#) on page 3-4
- [Ending Active Calls](#) on page 3-4
- [Muting the Microphone](#) on page 3-4
- [Redialing Numbers](#) on page 3-5
- [Holding and Resuming Calls](#) on page 3-5
- [Hosting Conference Calls](#) on page 3-6
- [Transferring Calls](#) on page 3-9
- [Forwarding Calls](#) on page 3-10
- [Using Do Not Disturb](#) on page 3-13
- [Managing Speed Dial Entries](#) on page 3-14
- [Using Voice Mail](#) on page 3-16

For information on the advanced features of your phone, see [Chapter 4, Using the Advanced Features of Your Phone](#).

Placing Calls

You can place a call off-hook (with a dial tone), or on-hook (without a dial tone). If you place a call off-hook, you have the option of dialing a contact using a URL or IP address, if this feature is enabled for your phone. You can also place calls (on-hook and off-hook) using speed dial numbers (see [Placing Calls Using Speed Dials](#) on page 3-3).

The phone displays the duration of active calls on the phone screen. The following figure shows an active call to Jane Smith at directory number 1951 that has lasted for nine seconds.

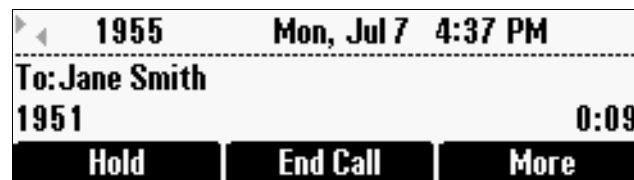

To place a call off-hook (to dial a phone number, IP address, or URL):

Note

Placing calls using an IP address or URL may not be enabled for your phone. For more information, see your system administrator.

1. To obtain a dial tone, press  or the **New Call** soft key.
2. Do one of the following:
 - To dial a phone number, enter the phone number of the party you want to call.
 - To dial an IP address or URL, press the **URL** soft key, and then enter the IP address or URL of the party you want to call.

To enter the number and letters displayed on a key, press the key one or more times quickly.

To enter “@”, press the # key. To enter “.”, press the * key.

Note

When you dial a URL, the maximum number of characters you can enter is 32.

3. Press the **Send** soft key.

To place a call on-hook (to dial a phone number):

- >> Enter the phone number of the party you want to call, and then press the **Dial** soft key.

Note

Instead of entering a phone number from memory, you can access call lists, directories, and speed dial lists to display and dial the number for you.

- To access a call list, press the **Menu** key, and then select **Features > Call Lists > Missed Calls, Received Calls, or Placed Calls**. Scroll to the call you want to dial, and then press the **Dial** soft key. For more information, see [Using Call Lists](#) on page 2-10.
- To access your Contact Directory or Corporate Directory (if enabled for your phone), press the **Menu** key, and then select **Features > Contact Directory or Corporate Directory**. Scroll to or search for the contact you want to dial, and then press the **Dial** soft key. For more information, see [Managing Contacts](#) on page 2-12.
- To place a call using a speed dial index number, press the **Up** scroll key, scroll to the party you want to call, and then press the **Dial** soft key. For more information on other ways to use speed dial, see [Placing Calls Using Speed Dials](#) on page 3-3.

Placing Calls Using Speed Dials

Use a speed dial index number for quick dialing. Speed dial index numbers are associated with entries in your Contact Directory. For information on managing speed dial entries from your Contact Directory, see [Managing Speed Dial Entries](#) on page 3-14.

To place a call using a speed dial index number:

1. Press .

The Speed Dial Info screen displays.

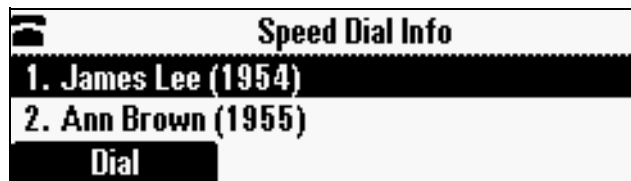

2. Do one of the following:
 - If you know the contact's speed dial index number, enter the number.
 - or
 - If you do not know the contact's speed dial index number, scroll to the contact, and then press the **Dial** soft key.

The call is placed.

Answering Calls

To answer a call:

>> Press  or the **Answer** soft key.

The three LEDs flash green when the phone rings.

Note

To ignore Incoming calls, press the **Reject** soft key (for private lines) or the **Silence** soft key (for shared lines). To prevent your phone from ringing, enable the **Do Not Disturb** feature (see [Using Do Not Disturb](#) on page 3-13).

You can forward incoming calls by pressing the **Forward** soft key (see [Forwarding Calls Dynamically](#) on page 3-13).

If you set up your phone with a silent ring, press the **Answer** soft key to answer the call.

To answer a call on a shared line:

1. Answer the incoming call.
2. Press the **Hold** soft key.

Anyone on another phone configured to use the same shared line can take the call by selecting the call on their phone screen.

Ending Active Calls

To end a call:

>> Press  or the **End Call** soft key.

Note

You cannot end a call that is on hold until you resume the call. To end a call on hold, press the **Resume** soft key, and then end the call.

Muting the Microphone

To mute the microphone:

>> During a call, press .

The three console LEDs glow red to indicate that the other party (or parties) cannot hear you. You can still hear all other parties while Mute is enabled.

To turn off the Mute feature, press  again.

To mute the microphone if you use external microphones:

>> Press  on the phone or the  button on the top of the external microphones.

To turn off the Mute feature, press  again.

Redialing Numbers

You can redial the last number you dialed, or search a list of placed calls to find a previously-dialed number.

To redial the last number dialed:

>> Press .

To redial a previously dialed number:

1. Press , and then select **Features > Call Lists > Placed Calls**.

The Placed Calls screen displays.

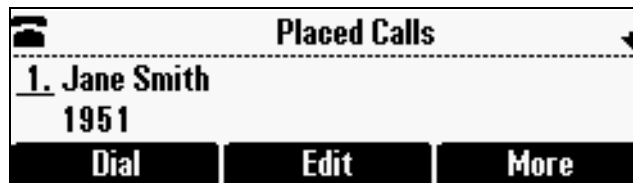

2. Scroll to the number you want to redial, and then press the **Dial** soft key.

Holding and Resuming Calls

You can place up to eight calls on hold on your phone.

(For information on placing conference calls on hold, see [Holding and Resuming Conferences](#) on page 3-8.)

To place a call on hold:

>> During a call, press the **Hold** soft key. The console LEDs flash red to indicate that a call is on hold.

The following screen shows Jane Smith on hold. The Resume soft key now displays on the screen.

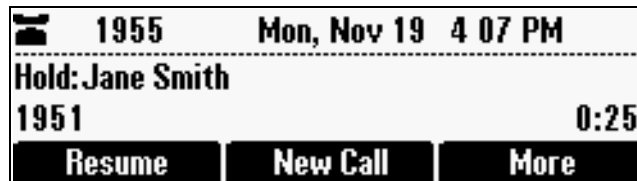

To resume a call on hold:

>> While a call is on hold, press the **Resume** soft key.

Note

To end a call on hold, you must resume the call first.

Hosting Conference Calls

You can create a conference with up to two other parties using the phone's local conference feature. To quickly set up a conference, you can use the **Join** soft key to create a conference between an active call and a call on hold.

After you set up a conference, you can hold the conference call, split the conference call into individual calls on hold, or end the conference call (and your connection to the conference call participants).

This section includes the following topics:

- [Setting Up Conferences](#) on page 3-6
- [Holding and Resuming Conferences](#) on page 3-8
- [Splitting Conferences](#) on page 3-8
- [Ending Conferences](#) on page 3-9

Setting Up Conferences

You can set up a conference in one of two ways:

- Using the **Confrnc** soft key.
- Using the **Join** soft key, if you have an active call and a call on hold.

Setting Up a Conference Using the Conference Soft Key

To set up a conference using the Conference soft key:

1. Call the first party. See [Placing Calls](#) on page 3-2.
2. Press the **Confrnc** soft key. The active call is placed on hold.

Note

If configured for single key-press conferences, the conference participant hears the dial tone and ringback when the conference host places the call to the new party.

3. Enter the number of the second party, and then press the **Send** soft key.
4. When the second party answers, press the **Confrnc** soft key to join all parties in the conference.

Note

If configured for single key-press conferences, you do not have to press the **Confrnc** soft key again.

The Active:Conference screen displays.

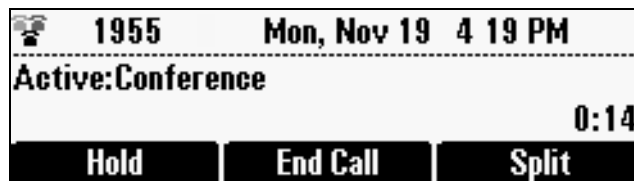

Setting Up a Conference with an Active Call and a Call on Hold

If you are currently in an active call, and you have another call on hold, you can create a conference call between the active call, the call on hold, and yourself, by pressing the **Join** soft key.

To set up a conference call with an active call and a call on hold:

- >> If you have an active call and a call on hold, scroll to either call, and then press the **Join** soft key.

The Active:Conference screen displays.

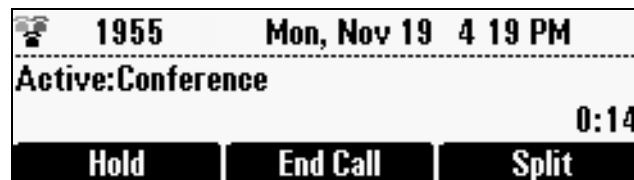

A conference is created with the active call, the call on hold, and yourself.

Holding and Resuming Conferences

When you place a conference call on hold, you place all other conference participants on hold.

To place a conference call on hold:

>> From the Active:Conference screen, press the **Hold** soft key.

The Hold:Conference screen displays. The other parties in the conference call are put on hold.

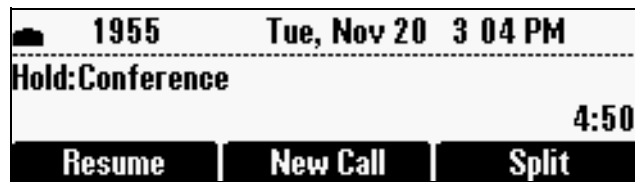

From the Hold:Conference screen, you can do the following:

- To resume the conference call, press the **Resume** soft key. The Active:Conference screen will display again.
- To place a call to a new party, press the **New Call** soft key. The conference remains on hold, and the new call becomes the active call.
- To end the conference call and split the conference into two separate calls on hold, press the **Split** soft key.

Splitting Conferences

When a conference has been established, a **Split** soft key is available. When you split a conference, you end the conference and put all parties on hold.

To split a conference:

>> From the Active:Conference screen, press the **Split** soft key.

The conference ends, and all calls are split into individual calls and put on hold.

Ending Conferences

You can end a conference, and your connection to the other parties, by pressing the **End Call** soft key. When you use the End Call soft key, the other parties remain connected.

To end a conference:

>> From the Active:Conference screen, press the **End Call** soft key.

The two other parties remain connected.

Transferring Calls

A call can be transferred in one of three ways:

- Consultative transfer – You have the option of either talking to the party to whom you are transferring the call, or you can choose not to talk to the party, and complete the transfer when you hear the party's ring-back sound.
 - [Performing a Consultative Transfer](#) on page 3-9.
- Blind transfer – The call is automatically transferred after you dial the number of the party to whom you want to transfer the call. You do not have the option of talking to the party.
 - [Performing a Blind Transfer](#) on page 3-10.
- Attended transfer – The parties are automatically connected to each other after you exit a conference.
 - Set up a conference call and then end your participation. For more information, see [Setting Up Conferences](#) on page 3-6 and [Ending Conferences](#) on page 3-9.

Performing a Consultative Transfer

Perform a consultative transfer if you want to talk to the party to whom you are transferring the call. Or, you can choose not to talk to the party. In this case, you wait for the party's ring-back sound, and then transfer the call.

To transfer a call:

1. During a call, press the **Trnsfer** soft key. The active call is placed on hold.
2. Place a call to the party to whom you want to transfer the call. See [Placing Calls](#) on page 3-2.

3. When you hear the ring-back sound, press the **Trnsfer** soft key. The transfer is complete.

If you want to talk privately to the person to whom you are transferring the call before the transfer is complete, wait until the person answers the call, talk to the person, and then press the **Trnsfer** soft key.

To cancel the transfer before the call connects, press the **Cancel** soft key.

Performing a Blind Transfer

When you use a blind transfer, you transfer a call without speaking to the party to whom you are transferring the call. The call is automatically transferred as soon as you dial the party's number.

To perform a blind transfer:

1. During a call, press the **Trnsfer** soft key.

The following screen, with the Blind soft key, displays.



2. Press the **Blind** soft key, and then place a call to the party to whom you want to transfer the call. See [Placing Calls](#) on page 3-2.

(If you want to cancel the transfer before the call is placed, and return to the original call, press the **Cancel** soft key.)

The call automatically transfers to the party you specified.

Forwarding Calls

Note

Your company's settings may override this feature. For more information, contact your system administrator.

Call forwarding is not available on shared lines.

You can set up your phone to forward incoming calls to another party (static forwarding), or you can forward a call as your phone rings (dynamic forwarding). Your phone will forward calls even if you enable the Do Not Disturb Feature.

You can also reject calls from a particular contact (by sending the call to your voice mail system), or divert calls from a particular contact to another party. For more information, see [Managing Incoming Calls](#) on page 2-24.

To access forwarding options:

>> Do one of the following:

- Press , and then select **Features > Forward**.

or

- From the idle screen, press the **Forward** soft key.

Forwarding Calls Staticly

You can set up your phone to forward calls to another number.

To forward calls to another extension:

1. From the idle screen, press the **Forward** soft key.

The Forwarding Type Select screen displays.

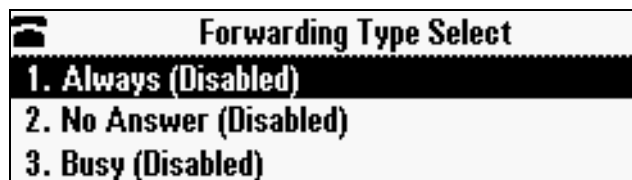

2. Scroll to the forwarding type you want, and then press . The options are:
 - **Always** – To forward all incoming calls.
 - **No Answer** – To forward all unanswered incoming calls.
 - **Busy** – To forward calls that arrive when you are already in a call.
3. Do one of the following:
 - If you selected **Always**, the Call Forward Always screen displays.



Enter a number to forward all incoming calls to.

- If you selected **No Answer**, the Call Forward No Answer screen displays.



Do the following (use the **Next** and **Prev** soft keys to move between fields):

- In the **Contact** field, enter a number to forward all unanswered incoming calls to.
 - In the **Forward After Rings** field, enter how many rings to wait before forwarding the call (one ring is approximately six seconds). Two rings is the recommended value.
- If you selected **Busy**, the Call Forward Busy screen displays.



Enter a number to forward all future incoming calls to when you are already in another call.

4. Press the **Enable** soft key.

If you selected the forwarding type **Always**, a moving arrow displays on the idle screen next to the directory number.

To disable call forwarding:

1. From the idle screen, press the **Forward** soft key.

The Forwarding Type Select screen displays, showing the forwarding type that is enabled.

The following screen shows the forwarding type "Always" enabled.

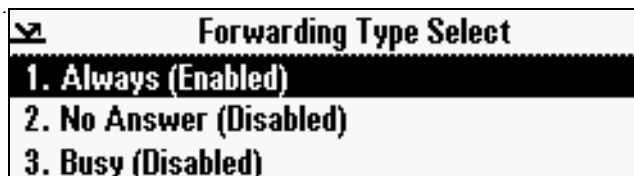

2. Scroll to the forwarding type you want to change, and then press **SELECT**.
A screen displays showing the details of the forwarding type you want to disable.



3. To turn off call forwarding, press the **Disable** soft key.

Forwarding Calls Dynamically

You can manually forward a call to another number while your phone rings.

To forward an incoming call to another extension:

1. While your phone rings, press the **Forward** soft key.

The Call Forwarding screen displays.



2. Enter the number to forward the incoming call to.

Your phone displays the last number you forwarded calls to (either statically or dynamically). If you previously set a forwarding number and want to enter a new one, use the **<<** soft key to delete the number.

3. Press the **Forward** soft key.

The incoming call is forwarded to the other party. If call forwarding is disabled, future calls will not be forwarded and forwarding remains disabled.

Using Do Not Disturb

To prevent your phone from ringing, activate the Do Not Disturb feature.

Calls you receive while Do Not Disturb is enabled will display in your Missed Calls Call List (see [Using Call Lists](#) on page 2-10). If you have chosen to forward your calls to another number, calls will be sent to that number if Do Not Disturb is enabled.



To enable and disable Do Not Disturb:

1. Press , and then select **Features**.

The Features screen displays. If Do Not Disturb is not highlighted, scroll to it.





2. To toggle Do Not Disturb on or off, press .

When you enable Do Not Disturb, a flashing icon, , displays at the top left of the screen. When you disable Do Not Disturb, the registered line icon, , displays instead.

The following figure shows what the Features menu looks like with Do Not Disturb enabled.



3. Press , to return to the idle screen.

If you enabled Do Not Disturb, the idle screen displays a flashing icon, , next to the directory number.

Managing Speed Dial Entries

Use the speed dial feature for fast, automated dialing. To use speed dial, you enter a speed dial index number instead of entering a complete phone number.

When you create a Contact Directory entry, the phone automatically assigns a Speed Dial Index number to the entry. You can change the index number or delete it.

Note

Only entries in your Contact Directory can be set up as speed dial entries. To create a new Contact Directory entry with a speed dial index number, see [Adding Contacts to Your Local Contact Directory](#) on page 2-14.

The following steps describe how to update a speed dial entry for a user. For information on how to place a call using a speed dial number, see [Placing Calls Using Speed Dials](#) on page 3-3.

To update a speed dial entry in your contact directory:

1. Press , and then select **Features > Contact Directory**.

The Directory screen displays.



2. Scroll to the user's entry, and then press the **Edit** soft key.

The Edit Contact screen displays.



3. Use the **Next** and **Prev** soft keys to scroll to the Speed Dial Index field, and then update the speed dial index number. Use the << soft key to delete an existing entry.

You can assign any unused speed dial index number from 1 to 99. If you assign a speed dial index number that is already taken, the message "Speed dial index already exists" displays. If you enter an invalid speed dial index number (for example, 0 or 00), the message "Speed dial index is invalid" displays.

4. Press the **Save** soft key.
5. Press  to return to the idle screen.

Using Voice Mail

Note

Voice mail is an optional feature that your system administrator sets up. Your system may not support it. For more information, contact your system administrator. Screen options may vary with your application. Voice mail may be accessible with a single key press. Contact your system administrator about this option.

Your voice mail is saved in a centralized location and may be accessed from your phone. Your phone may indicate voice mail by the following:

- An icon, , on the phone screen
- A stutter dial tone instead of a normal dial tone

To listen to voice mail messages:

1. Press , and then select **Features > Messages > Message Center**.

The Messages screen displays, indicating the number of urgent, new, and old messages you have.



2. To listen to your voice mail, press the **Connect** soft key, and then follow the voice or visual prompts on the screen.
3. Press  to return to the idle screen.

Using the Advanced Features of Your Phone

This chapter provides operating instructions for the advanced features of the SoundStation IP 6000 conference phone. If you require additional information or assistance with these features, contact your system administrator.

For information on the basic features of your phone, see Chapter 3, [Using the Basic Features of Your Phone](#).

This chapter includes the following topics:

- [Handling Multiple Call Appearances](#) on page 4-1
- [Using Buddy Lists](#) on page 4-2
- [Using Instant Messaging](#) on page 4-8
- [Restarting the Phone](#) on page 4-10

Handling Multiple Call Appearances

Your system administrator can set up your phone to have one or more call appearances. If your phone is set up to have multiple call appearances, your phone screen can display information for multiple calls, and you can handle active and held calls at the same time. Your phone can handle a maximum of eight different calls, or eight “appearances” at one time.

If two or more calls are taking place, the phone displays a counter at the top right of the display. For example, in the following figure, “1/3” indicates that the call to James Lee is the first one out of a total of three.

To display the other two calls on hold, use the scroll keys.

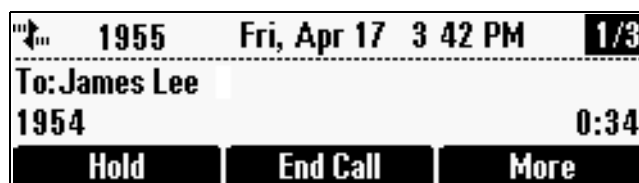

Using Buddy Lists

Note

Monitoring the status (presence) of contacts in a buddy list is an optional feature that your system administrator enables. Your system may not support it. For more information, contact your system administrator.

A buddy list is a list of users/devices whose status, or “presence,” you can monitor. Your contacts update their presence setting (for example, Be right back, Out to lunch, or Busy), and you can view their status in real time from your phone’s Buddy Status screen. If you like, you can block others from monitoring your status.

Your phone can “watch” the status of up to eight other phones. These phones form your “buddy list.” Your phone can be monitored by up to eight other phones.

If your phone is configured to work with Microsoft Office Live Communications Server 2005, the behavior of presence settings and buddy lists is different. For more information, see [Integrating with Microsoft Office Live Communications Server 2005](#) on page 4-7, or contact your system administrator.

Updating Presence Settings



Your presence setting indicates your status (either online, busy, be right back, away, out to lunch, offline, or do not disturb). Update your presence setting so that other users can monitor your status from their phones.

To change your presence setting:

1. Do one of the following:
 - Press , and then select **Features > Presence > My Status**.
 - or
 - From the idle screen, press the **MyStat** soft key.

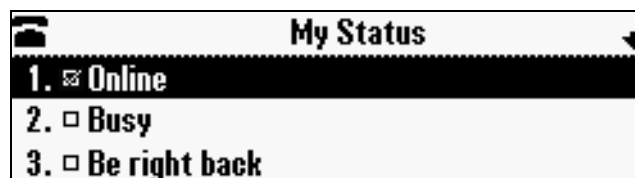
The My Status screen displays.



2. Scroll to the status you want, and then press . The default status is Online.
3. Press  to return to the idle screen.

The following figure shows what the idle screen looks like when you assign a presence status (in this case, “Be right back”). If you assign the status “Online” (the default status), the presence status does not display on the screen.

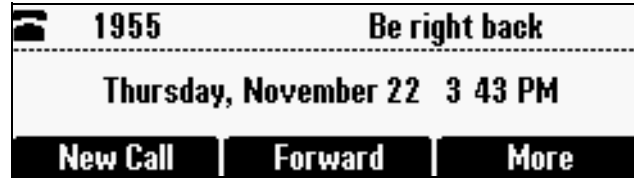

Selecting Contacts to Monitor

Select the contacts whose presence you want to monitor by updating the contacts in your buddy list. You add contacts to your buddy list from your local Contact Directory. To view the status of contacts in your buddy list, see [Monitoring the Status of Contacts in Your Buddy List](#) on page 4-6.

Note

If your call server is Microsoft Office Live Communications Server 2005, see [Integrating with Microsoft Office Live Communications Server 2005](#) on page 4-7.

To update your buddy list:

1. Press , and then select **Features > Contact Directory**.

The Directory screen displays.



2. Scroll to the contact. Or, search for the contact (see [Searching for Contacts in Your Local Contact Directory](#) on page 2-19).

To scroll through a list of contacts, use the * key to Page Up and the # key to Page Down.

3. Press the **Edit** soft key.

The Edit Contact screen displays.



4. Use the **Next** and **Prev** soft keys to scroll to the **Watch Buddy** field, and then use the scroll keys or the **Change** soft key to choose **Enabled** or **Disabled**.

When Watch Buddy is enabled, the contact is added to your buddy list and you can monitor the contact's status. When Watch Buddy is disabled, the contact is removed from your buddy list and you cannot monitor the contact's status.

The default for Watch Buddy is Disabled.

5. Press the **Save** soft key.
6. Press  to return to the idle screen.

Blocking Contacts from Viewing Your Status

Block a contact in your Contact Directory if you don't want the contact to view your status. If you unblock a contact, the contact can add you to their buddy list and view your status. You can also use your Blocked List to unblock contacts (see [Using Your Blocked List to Unblock Contacts](#) on page 4-6).

Note

To view a list of contacts that can and cannot monitor your status, do the following:

- To view contacts that cannot view your status, press the **Menu** key, and then select **Features > Presence > Blocked List**.
- To view contacts that can view your status, press the **Menu** key, and then select **Features > Presence > Watcher List**.

To block or unblock a contact:

1. Press , and then select **Features > Contact Directory**.

The Directory screen displays.



2. Scroll to the contact. Or, search for the contact (see [Searching for Contacts in Your Local Contact Directory](#) on page 2-19).

To scroll through a list of contacts, use the * key to Page Up and the # key to Page Down.

3. Press the **Edit** soft key.

The Edit Contact screen displays.



4. Use the **Next** and **Prev** soft keys to scroll to the **Block Buddy** field, and then use the scroll keys or the **Change** soft key to choose **Enabled** or **Disabled**.

When Block Buddy is enabled, the contact cannot watch your phone. The contact will display in your Blocked List.

When Block Buddy is disabled, the contact can watch your phone. The contact will display in your Watcher List.

The default for Block Buddy is Disabled.

5. Press the **Save** soft key.
6. Press  to return to the idle screen.

Using Your Blocked List to Unblock Contacts

Use the Blocked List to quickly unblock a contact, rather than updating the Block Buddy setting for the contact in your Contact Directory.

To use your Blocked List to unblock a contact:

1. Press , and then select **Features > Presence > Blocked List**.

The Blocked List screen displays.



2. Scroll to the contact.
3. Press the **Unblock** soft key.
4. Press  to return to the idle screen.

The contact can now watch your phone. The contact will display in your Watcher List. (To view your Watcher List, press the **Menu** key, and then select **Features > Presence > Watcher List**.)

Monitoring the Status of Contacts in Your Buddy List

You can monitor the status of all the contacts in your buddy list, except those contacts that have blocked you from viewing their status. (To add contacts to your buddy list, see [Selecting Contacts to Monitor](#) on page 4-3.)

To monitor a contact in your buddy list:

>> Do one of the following:

- From the idle screen, press the **Buddies** soft key.

or

- Press , and then select **Features > Presence > Buddy Status**.

The Buddy Status screen displays, listing the status of all your buddies. From this screen, you can scroll to and dial the contact.

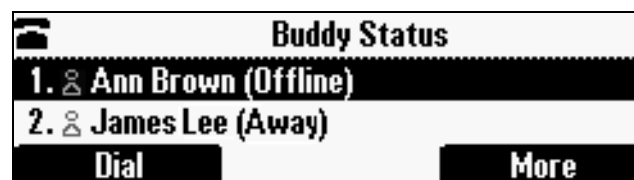



Integrating with Microsoft Office Live Communications Server 2005

Your system administrator can configure your phone to work with Microsoft Office Live Communications Server 2005 and communicate with others using Microsoft Office Communicator and Windows Messenger. From your phone, you can invite, join, control, and monitor integrated multipoint conferences.

Any contact added through your buddy list will appear as a contact in Microsoft Office Communicator and Windows Messenger. Any contact added as a contact in Microsoft Office Communicator and Windows Messenger will appear in your buddy list. You can access your Privacy List on the phone to allow or disallow your contacts from monitoring your presence.

To view and change your presence, see [Updating Presence Settings](#) on page 4-2. For more information on integrating with Microsoft Office Live Communications Server 2005, contact your system administrator.

To add a contact to your buddy list:

1. Press , and then select **Features > Presence > Buddy Status**.
2. Press the **Add** soft key.
3. Enter the phone number of the contact.
4. Press the **Submit** soft key.
5. Press  to return to the idle screen.

To view and change your privacy list:

1. Press , and then select **Features > Presence > Buddy Status > Privacy List**.
2. Scroll to the contact.
3. Press the **Edit** soft key.
4. Scroll to **Access**, and then use the scroll keys to select **Enabled**.

When Access is enabled, you allow the contact to see your presence. When Access is disabled, you prevent the contact from viewing your presence.

The default for Access is Disabled.

5. Press  to return to the idle screen.

For more information on contacting buddies, see the Microsoft Office Communicator and Windows Messenger documentation.

Using Instant Messaging

Note

Instant Messaging is an optional feature that your system administrator enables. Your system may not support it. For more information, contact your system administrator.

You can send and receive instant messages using your phone. Your phone may indicate instant messages by the following:

- An icon, , on the phone screen
- A stutter dial tone instead of a normal dial tone

Managing Instant Messages

From the Instant Messages screen, you can view instant messages, delete a message, or create a new message. Messages display in the order they are received (the first message received displays first).

To manage instant messages:

1. Press , and then select **Features > Messages > Instant Messages**.
2. From the Instant Messages screen, you can do the following:
 - To view instant messages, press the **Next** or **Prev** soft keys to cycle through the messages in order.
 - To delete a message, press the **Next** or **Prev** soft keys to scroll to the message, and then press the **Delete** soft key.
 - To create a new message, press the **New** soft key. (See [Sending Instant Messages](#) on page 4-9.)

Sending Instant Messages

To send an instant message:

1. Press , and then select **Features > Messages > Instant Messages**.
The Instant Messages screen displays.



2. Do one of the following:
 - To send a message, press the **New** soft key.
Enter the phone number or IP address, and then press the **Ok** soft key. Or, to enter a URL, press the **1/A/a** soft key to select uppercase or lowercase mode, enter the URL, and then press the **Ok** soft key.
(To enter special characters, see [Navigating Menus and Entering Data](#) on page 1-12.)

or

- To reply to a message, press the **Next** or **Prev** soft keys to select a message. Then, press the **Reply** soft key.

The Instant Messages screen displays. The phone number or URL you entered or selected displays on the screen.



3. Do one of the following:
 - To choose from various pre-scripted short messages, press the **Select** soft key. From the Message Select screen, scroll to the message you want.
- or
- To compose a custom message, press the **Edit** soft key. Then, enter your message. (To enter a message, see [Navigating Menus and Entering Data](#) on page 1-12.)
4. Press the **Send** soft key.
5. Press  to return to the idle screen.

Restarting the Phone

Note

If your phone malfunctions, you may be able to restore normal operation without restarting it. Before you restart your phone, contact your system administrator.

Periodically, you may need to restart your phone so your phone can accept a new configuration.

Note

Call lists are automatically cleared when you restart your phone.

To restart the phone:

1. Press , and then select **Settings > Basic > Restart Phone**.

The Restart Phone screen displays. The message “Are you sure?” displays.



2. If you still want to restart the phone, press the **Yes** soft key.

The restart process begins. The process ends when the idle screen displays.

Troubleshooting Your Phone

This chapter contains general troubleshooting information to help you solve any problems you might encounter when you use the SoundStation IP 6000 conference phone. The tables in this chapter list possible trouble symptoms, the likely causes of these problems, and recommended corrective actions to take. Problems are grouped as follows:

- [Installation Configuration](#) on page 5-2
- [Power and Startup](#) on page 5-2
- [Controls](#) on page 5-3
- [Access to Screens and Systems](#) on page 5-4
- [Calling](#) on page 5-5
- [Displays](#) on page 5-6
- [Audio](#) on page 5-6
- [Productivity Suite](#) on page 5-6

To obtain more detailed troubleshooting information, you can access certain menus on your phone that test your phone hardware. For more information, see [Testing Phone Hardware](#) on page 5-7.

If you require more information or assistance, contact your system administrator.

Installation Configuration

Symptom	Problem	Corrective Action
The display shows: “General configuration error Unsupported configuration Undo last configuration change.”	The phone installation configuration is not supported.	Verify that you have installed the phone and any components correctly: <ul style="list-style-type: none"> • See Installing the Phone on page 1-2. • Check that no more than two microphones are installed. • Contact your system administrator.

Power and Startup

Symptom	Problem	Corrective Action
The display shows “Network Link is Down.”	The network cable is not properly connected.	Verify that the network cable is properly connected: <ul style="list-style-type: none"> • Check the cable termination at the switch or hub (furthest end of the cable from the phone). • Check that the switch or hub is operational (flashing link/status lights). • Check if the LAN port is active or inactive. Press the Menu key, and then select Status > Network > Ethernet. From the Ethernet screen, scroll to LAN port and verify that it is Active. <div data-bbox="1019 1325 1417 1434" style="border: 1px solid black; padding: 5px; margin: 10px 0;"> <p style="text-align: right; margin: 0;">Ethernet</p> <hr style="border-top: 1px dashed black; margin: 0;"/> <p>LAN port: Active LAN Speed: 100Mbps LAN Mode: Full-duplex</p> </div> <ul style="list-style-type: none"> • To attempt re-registration with the call server, reboot the phone. For more information, see your system administrator. • Contact your system administrator.

Controls

Symptom	Problem	Corrective Action
<p>The dial pad does not work.</p>	<p>The dial pad on the phone does not respond.</p>	<p>Try the following:</p> <ul style="list-style-type: none"> • Check for a response from other feature keys or from the dial pad. • Place a call to the phone from a known working telephone. Check for display updates. • Check if the LAN port is active or inactive. Press the Menu key, and then select Status > Network > Ethernet. From the Ethernet screen, scroll to LAN port and verify that it is Active. <div data-bbox="1019 810 1417 919" style="border: 1px solid black; padding: 5px; margin: 10px 0;"> <p style="text-align: right; margin: 0;">Ethernet</p> <hr style="border: 0.5px dashed black; margin: 2px 0;"/> <p>LAN port: Active LAN Speed: 100Mbps LAN Mode: Full-duplex</p> </div> <ul style="list-style-type: none"> • Check the termination at the switch or hub end of the network LAN cable. Ensure that the switch/hub port is operational (if it is not accessible, contact your system administrator). • Before restarting your phone, contact your system administrator. Your system administrator may want to troubleshoot the phone in more detail before restarting the phone and losing current status information.

Access to Screens and Systems

Symptom	Problem	Corrective Action
There is no response when you press a feature key.	The phone is not in an active state.	<p>Try the following:</p> <ul style="list-style-type: none"> Press the keys more slowly. Call the phone to confirm that inbound call display and ringing is normal. If successful, try to press feature keys within the call to access the Directory or Buddy Status screens, for example. To confirm the line is actively registered to the call server, press the Menu key, and then select Status > Lines > Line Information. From the Line Information screen, verify that your phone line is registered. <div data-bbox="1019 835 1414 940" style="border: 1px solid black; padding: 5px; margin: 10px 0;"> <p style="text-align: center;">Line Information</p> <hr style="border: 0.5px dashed black;"/> <p>Line1: 1955 (Registered 25:40:35) Server-1: r13as1:0</p> </div> <ul style="list-style-type: none"> To attempt re-registration with the call server, reboot the phone. For more information, see your system administrator.
The display shows “Network Link is Down.”	The network cable is not properly connected.	See Power and Startup on page 5-2.

Calling

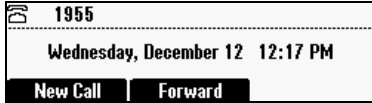
Symptom	Problem	Corrective Action
There is no dial tone.	Power is not correctly applied to the phone.	<p>Verify that power is correctly applied to the phone:</p> <ul style="list-style-type: none"> • Check that the display is illuminated. • Ensure the network cable is inserted properly on the underside of the phone. (Try unplugging and re-inserting the cable.)
There is no audible ring tone.	Ringer volume is low, or the Ring Type is set to Silent Ring.	<p>Verify ringer volume and Ring Type:</p> <ul style="list-style-type: none"> • To adjust the ringer volume, press either of the volume keys when the phone is in the idle state. • Check that the Ring Type is not set to Silent Ring. (See Updating the Ring Tone on page 2-8.)
	Outbound or inbound calling is unsuccessful.	Place a call to the phone under investigation. Check that the display indicates incoming call information.
<p>A “hollow” phone icon displays at the top of the screen.</p> 	The phone is not registered to a server.	Ask your system administrator to register the phone to a server.

Displays

Symptom	Problem	Corrective Action
There is no display. The display is incorrect. The display has bad contrast.	Power is not correctly applied to the phone.	Verify that power is correctly applied to the phone: <ul style="list-style-type: none"> • Check that the display is illuminated. • Ensure the network cable is inserted properly on the underside of the phone. (Try unplugging and re-inserting the cable.) • If your phone uses Power over Ethernet (PoE), have your system administrator check that the switch is supplying power to the phone.
	The contrast needs adjustment.	Adjust the screen contrast. (See Updating the Display Contrast on page 2-5.)
The display is flickering.	Certain types of older fluorescent lighting cause the display to appear to flicker.	Try the following: <ul style="list-style-type: none"> • Move the phone away from the lights. • Replace the lights.

Audio

Symptom	Problem	Corrective Action
The speaker has no audible sound.	Speaker volume is low.	Adjust the speaker volume. During a call, press the volume keys to adjust the volume.

Productivity Suite

Symptom	Problem	Corrective Action
You are trying to access Corporate Directory, but it is not available on your phone.	The license is not installed on your phone or it has expired.	Do the following: <ol style="list-style-type: none"> 1. Press the Menu key, and then select Status > Licenses. 2. Using the arrow keys, verify that the feature you want to use has a valid license. For more information, contact your system administrator.

Testing Phone Hardware

Your system administrator may ask you to access a diagnostics menu on your phone to test your phone hardware. From the diagnostics menu, you can test your phone's microphones, keypad mappings, and display. See your system administrator for instructions on how to perform these tests.

To access the diagnostics menus:

>> Press , and then select **Status > Diagnostics > Test Hardware > Audio Diagnostics, Keypad Diagnostics, or Display Diagnostics.**

Safety Notices

Service Agreements

Please contact your Polycom Authorized Reseller for information about service agreements applicable to your product.

Governing Law

This Limited Warranty and Limitation of Liability shall be governed by the laws of the State of California, U.S.A., and by the laws of the United States, excluding their conflicts of laws principles. The United Nations Convention on Contracts for the International Sale of Goods is hereby excluded in its entirety from application to this Limited Warranty and Limitation of Liability.

All rights reserved under International and Pan-American Copyright Conventions. No part of the contents of this manual may be copied, reproduced, or transmitted in any form or by any means, or translated into another language or format, in whole or part, without written consent from Polycom, Inc. Do not remove (or allow anybody else to remove) any product identification, copyright or other notices.

Limitations of Liability

LIMITATION OF LIABILITY. TO THE FULL EXTENT ALLOWED BY LAW, POLYCOM EXCLUDES FOR ITSELF AND ITS SUPPLIERS ANY LIABILITY, WHETHER BASED IN CONTRACT OR TORT (INCLUDING NEGLIGENCE), FOR INCIDENTAL, CONSEQUENTIAL, INDIRECT, SPECIAL, OR PUNITIVE DAMAGES OF ANY KIND, OR FOR LOSS OF REVENUE OR PROFITS, LOSS OF BUSINESS, LOSS OF INFORMATION OR DATA, OR OTHER FINANCIAL LOSS ARISING OUT OF OR IN CONNECTION WITH THE SALE, INSTALLATION, MAINTENANCE, USE, PERFORMANCE, FAILURE, OR INTERRUPTION OF ITS PRODUCTS, EVEN IF POLYCOM OR ITS AUTHORIZED RESELLER HAS BEEN ADVISED OF THE POSSIBILITY OF SUCH DAMAGES, AND LIMITS ITS LIABILITY TO REPAIR, REPLACEMENT, OR REFUND OF THE PURCHASE PRICE PAID, AT POLYCOM'S OPTION. THIS DISCLAIMER OF LIABILITY FOR DAMAGES WILL NOT BE AFFECTED IF ANY REMEDY PROVIDED HEREIN SHALL FAIL OF ITS ESSENTIAL PURPOSE.

Polycom Limited Warranty and Limitation Liability

LIMITED WARRANTY. Polycom warrants to the end user (“Customer”) that this product is expected to be free from defects in workmanship and materials, under normal use and service, for one year from the date of purchase from Polycom or its authorized reseller.

Polycom’s sole obligation under this express warranty is at Polycom’s option and expense, to repair the defective product or part, deliver to Customer an equivalent product or part to replace the defective item, or if neither of the two foregoing options are reasonably available, Polycom may, on its sole discretion, refund to Customer the purchase price paid for the defective product. All products that are replaced will become the property of Polycom. Replacement products or parts may be new or reconditioned.

Polycom is expected to warrant any replaced or repaired product or part for ninety (90) days from shipment, or the remainder of the initial warranty period, whichever is longer. Products returned to Polycom must be sent prepaid and packaged appropriately for safe shipment, and it is recommended that they be insured or sent by a method that provides for tracking of the package. Responsibility for loss or damage does not transfer to Polycom until the returned item is received by Polycom. The repaired or replaced item will be shipped to Customer, at Polycom’s expense, not later than thirty (30) days after Polycom receives the defective product, and Polycom will retain risk of loss or damage until the item is delivered to Customer.

Exclusions

Polycom will not be liable under this limited warranty if its testing and examination disclose that the alleged defect or malfunction in the product does not exist or results from:

- Failure to follow Polycom’s installation, operation, or maintenance instructions.
- Unauthorized product modification or alteration.
- Unauthorized use of common carrier communication services accessed through the product.
- Abuse, misuse, negligent acts or omissions of Customer and persons under Customer’s control; or
- Acts of third parties, acts of God, accident, fire, lightening, power surges or outages, or other hazards.

Warranty Exclusive

IF A POLYCOM PRODUCT DOES NOT OPERATE AS WARRANTED ABOVE, CUSTOMER’S SOLE REMEDY FOR BREACH OF THAT WARRANTY SHALL BE REPAIR, REPLACEMENT, OR REFUND OF THE PURCHASE PRICE PAID, AT POLYCOM’S OPTION. TO THE FULL EXTENT ALLOWED BY LAW, THE FOREGOING WARRANTIES AND REMEDIES ARE EXCLUSIVE AND ARE IN LIEU OF ALL OTHER WARRANTIES, TERMS, OR CONDITIONS, EXPRESS OR IMPLIED, EITHER IN FACT OR BY OPERATION OF LAW, STATUTORY OR OTHERWISE, INCLUDING WARRANTIES, TERMS, OR CONDITIONS OF MERCHANTABILITY, FITNESS FOR A PARTICULAR PURPOSE, SATISFACTORY QUALITY, CORRESPONDENCE WITH DESCRIPTION, AND NON-INFRINGEMENT, ALL OF WHICH ARE EXPRESSLY DISCLAIMED. POLYCOM NEITHER ASSUMES NOR AUTHORIZES ANY OTHER PERSON TO ASSUME FOR IT ANY OTHER LIABILITY IN CONNECTION WITH THE SALE, INSTALLATION, MAINTENANCE OR USE OF ITS PRODUCTS.

Safety and Compliance

Part 15 FCC Rules

This device is compliant with Part 15 of the FCC Rules. Operation is subject to the following two conditions:

1. This device may not cause harmful interference, and
2. This device must accept any interferences received, including interference that may cause undesired operation.

Class B Digital Device or Peripheral

Note: This equipment is tested and complies with the limits for a Class B digital device, pursuant to Part 15 of the FCC Rules. These limits are designed to provide reasonable protection against harmful interference in a residential installation. This equipment generates, uses, and can radiate radio frequency energy and, if not installed and used in accordance with the instructions, may cause harmful interference to radio communications. However, there is no guarantee that interference will not occur in a particular installation. If this equipment does cause harmful interference to radio or television reception, which can be determined by turning the equipment off and on, the user is encouraged to try to correct the interference by one or more of the following measures:

1. Reorient or relocate the receiving antenna.
2. Increase the separation between the equipment and receiver.
3. Connect the equipment into an outlet on a circuit different from that to which the receiver is connected.
4. Consult the dealer or an experienced radio/TV technician for help.

Modifications

In accordance with Part 15 of the FCC Rules, the user is cautioned that any changes or modifications not expressly approved by Polycom, Inc. could void the user's authority to operate the equipment. This equipment may not be used on a coin service or party line.

Installation Instructions

Installation must be performed in accordance with all relevant national wiring rules.

L'Installation doit être exécutée conformément à tous les règlements nationaux applicable au filage électrique.

When using Power over Ethernet (PoE), the equipment is to be connected only to PoE networks without connections to the outside plant.

Plugs Acts as Disconnect Device

The socket outlet to which this apparatus is connected must be installed near the equipment and must always be readily accessible.

La prise électrique à laquelle l'appareil est branché doit être installée près de l'équipement et doit toujours être facilement accessible.

Industry Canada (IC)

This Class [B] digital apparatus complies with Canadian ICES-003.

Cet appareil numérique de la classe [B] est conforme à la norme NMB-003 du Canada.

CE and VCCI Mark

This SoundStation IP 6000 phone is marked with the CE mark. This mark indicates compliance with EC Directives 2006/95/ED and 2004/108/EC. A full copy of the Declaration of Conformity can be obtained from Polycom Ltd., 270 Bath Road, Slough, Berkshire, SL1 4DX, UK.

この装置は、情報処理装置等電波障害自主規制協議会（VCCI）の基準に基づくクラスB情報技術装置です。この装置は、家庭環境で使用することを目的としていますが、この装置がラジオやテレビジョン受信機に近接して使用されると、受信障害を引き起こすことがあります。

取扱説明書に従って正しい取り扱いをして下さい。

Safety and Compliance (continued)

WARNING Electrical Safety

To avoid electric shock, do not connect safety extra low voltage (SELV) circuits to teleconference station network (TNV) circuits. LAN ports contain SELV circuit, and WAN ports contain TNV circuits. Some LAN and WAN ports both use RJ-45 connectors. Use caution when connecting cables.

This product is rated 48Vdc, 0.375A. When used with the optional external power supply, the power supply shall be a Listed power supply with a LPS output, rated 48V, min. 0.375A.

Russian Compliance

Ministry of Information Technologies & Communication of the Russian Federation - Declaration of Conformity.
DoC # СПД 1917. Expiry 03/28/2011.

New Zealand Telepermit

Polycom SoundStation IP 6000 Handsfree VoIP Conference Telephone PTC 216/08/012

PTC General Warning

The grant of a Telepermit for any item of terminal equipment indicates only that Telecom has accepted that the item complies with minimum conditions for connection to its network. It indicates no endorsement of the product by Telecom, nor does it provide any sort of warranty. Above all, it provides no assurance that any item will work correctly in all respects with another item of Telepermitted equipment of a different make or model, nor does it imply that any product is compatible with all of Telecom's network services.

Index

Symbols

key, page down shortcut 1-12

* key, page up shortcut 1-12

Numerics

1/A/a soft key, using 1-13

A

AC power adapters 1-3

AC Power Kit 1-2, 1-4

AC power, using 1-4

accessories, for phone 1-2

addresses, entering 1-12

answering calls 3-4

attended transfer, about 3-9

Audio Diagnostics menu 5-7

audio problems, troubleshooting 5-6

auto divert setting 2-16, 2-26

auto reject setting 2-16, 2-25

B

backlight idle intensity, about 2-6

backlight intensity, updating 2-6

backlight on intensity, about 2-6

Blind soft key 3-10

blind transfer, about 3-9

blind transfer, performing 3-10

block buddy setting 2-17, 4-5

Blocked List 4-4, 4-5

blocking and unblocking contacts 4-4

Buddies soft key 4-6

buddies, managing 4-2

buddy list, updating 4-3

buddy list, viewing 4-6

Buddy Status screen 4-2

C

call

appearances 4-1

forwarding 3-10

icons 1-11

key, about 1-9

lists, using 2-10

calling problems, troubleshooting 5-5

calls

answering 3-4

and call lists 2-10

dialing using speed dials 3-2, 3-3

distinguishing by ring type 2-24

diverting 2-25

ending 3-4

forwarding 3-10, 3-11

holding 3-5

ignoring 3-4

placing 3-2

redialing 3-5

rejecting 2-24, 3-4

resuming 3-5

transferring 2-25, 3-9

types of 3-2

characters, entering 1-13

clearing call list entries 2-12

clock order, changing 2-4

conference calls

about 3-6

ending 3-8, 3-9

holding 3-8

setting up 3-6

setting up with Join soft key 3-7

splitting 3-8

conference phone. *See* SoundStation IP 6000

Confrnc soft key 3-6

Connect soft key 3-16

consultative transfer 3-9

consultative transfer, performing 3-9

Contact Directory

- about 2-12
 - accessing 2-13
 - adding contacts to 2-14
 - deleting contacts from 2-22
 - managing 2-12
 - placing calls to contacts in 2-23
 - searching for contacts in 2-19
 - storing contacts in 2-12
 - updating contacts in 2-21
- contacts
- adding to Contact Directory 2-14
 - blocking and unblocking 4-4
 - calling 2-23
 - deleting 2-22
 - managing 2-12
 - saving from Corporate Directory 2-18
 - searching for in Contact Directory 2-19
 - searching for in Corporate Directory 2-20
 - setting ring types for 2-9
 - storing in Contact Directory 2-12
 - unblocking 4-6
 - updating 2-21
 - viewing in Contact Directory 2-13
 - viewing in Corporate Directory 2-13
- contrast, updating 2-5
- Corporate Directory
- about 2-12
 - accessing 2-13
 - placing calls to contacts in 2-23
 - saving contact to Contact Directory 2-18
 - saving search results for 2-14
 - searching for contacts in 2-20
 - and View Persistence setting 2-14
- customizing your phone 2-1

D

- data, entering 1-12
- date and time display, updating 2-3
- deleting text 1-13
- Diagnostics Menu, accessing 5-7
- dial pad keys, about 1-9
- dialing 3-2
- dialing, using IP addresses and URLs 3-2
- directory contacts, managing 2-12
- display contrast, updating 2-5
- Display Diagnostics menu 5-7
- display problems, troubleshooting 5-6
- divert contact setting 2-16, 2-26
- diverting calls 2-25
- Do Not Disturb feature 3-4, 3-13, 3-14
- dynamic forwarding 3-13

E

- Encoding soft key, about 1-13
- ending calls 3-4, 3-9
- exit key, about 1-10
- extension microphones 1-2, 1-5
- External Microphone Kit 1-2

F

- fields, enabling and disabling 1-13
- forwarding calls 3-10

H

- hardware, troubleshooting 5-7
- HD Voice, about 1-11
- holding calls 3-5, 3-8

I

- ignoring calls 3-4
- installation instructions 1-1
- installation issues, troubleshooting 5-2
- installing phone
 - using AC power 1-4
 - with extension microphones 1-5
 - using PoE 1-3
- instant messaging, using 4-8
- intensity, updating 2-6
- IP addresses, dialing 3-2
- IP addresses, entering 1-12

J

- Join soft key 3-6, 3-7

K

- key buttons, identifying 1-8
- Keypad Diagnostics menu 5-7
- keypad mappings, testing 5-7

L

- label setting 2-16
- LAN port, checking status of 5-2
- language, selecting for text 1-13
- language, updating for phone 2-2
- LED indicators, about 1-7
- letters, entering 1-13
- licenses, status of 5-6
- line and call icons 1-11
- line information, checking 5-4
- lowercase characters, entering 1-13

M

- maximum intensity, about 2-6
- menu key, about 1-10
- menus, navigating 1-12
- messages, accessing 3-16, 4-9
- messaging, using 4-8
- microphone, muting 3-4
- microphones, internal, about 1-7
- microphones, testing 5-7
- Microsoft Office Live Communications Server 2005 4-2, 4-7
- missed calls list 2-10
- missed calls list, shortcut to view 2-10
- More soft key, about 1-13
- multiple call appearances 4-1
- mute key, about 1-9
- muting the microphone 3-4
- MyStat soft key 4-2

N

- navigation keys, using 1-12
- network cable 1-2
- network, connecting phone to 1-3
- numbers, entering 1-13

O

- off-hook dialing, about 3-2
- on-hook dialing, about 3-2
- optional accessories for phone 1-2

P

- package contents 1-2
- parts list for phone 1-2
- phone controls, troubleshooting 5-3
- phone hardware, testing 5-7
- placed calls list 2-10
- placing calls 3-2
- PoE, using 1-3
- power adapter 1-2, 1-4
- power insertion cable 1-2, 1-4
- power issues, troubleshooting 5-2
- Power over Ethernet 1-3
- power source, connecting to phone 1-3
- Preferences menu, about 2-2
- presence settings 4-2
- presence settings, updating 4-2
- privacy list, updating 4-7
- productivity suite 5-6

R

- received calls list 2-10
- records, clearing in call lists 2-11, 2-12
- redial key, about 1-9
- redialing numbers 3-5
- regional power cord 1-2
- registered line, description of 1-11
- registering the phone 1-5
- registration status of phone 5-4
- Reject feature 3-4
- rejecting calls 2-24
- restarting the phone 2-11, 4-10
- Resume soft key 3-4, 3-6
- resuming calls 3-5, 3-8
- ring tones
 - and associated number 2-9
 - selecting 2-8
 - setting for contacts 2-9, 2-24
- ringer volume, adjusting 2-10

S

- scroll keys, about 1-8
- select key, about 1-8
- setting up the phone 1-2
- shared lines
 - about 2-26
 - answering calls on 3-4
 - and call forwarding 2-26
 - ignoring calls on 3-4
 - and rejecting calls 2-24
 - and the Silence feature 3-4
- silent ring, answering calls with 3-4
- soft keys, about 1-9
- SoundStation IP 6000
 - accessories for 1-2
 - customizing 2-1
 - features, list of 1-6
 - figure of 1-6, 1-8
 - hardware, testing 5-7
 - icons for 1-11
 - installing 1-1
 - key buttons, list of 1-8
 - language support for 2-2
 - menus, navigating 1-12
 - package contents 1-2
 - parts list for 1-2
 - restarting 4-10
 - settings, configuring 2-2
 - troubleshooting 5-1
- spaces, entering 1-13

- speaker volume, adjusting 2-10
- speaker, about 1-7
- special characters, entering 1-13
- speed dialing 3-3, 3-14
- Split soft key 3-8
- splitting conference calls 3-8
- standalone deployments, about 1-5
- startup issues, troubleshooting 5-2
- static forwarding 3-11
- status settings, updating 4-2

T

- testing phone hardware 5-7
- text messaging, using 4-8
- text, entering and deleting 1-13
- time and date display, updating 2-3
- transferring calls 3-9
- troubleshooting phone issues 5-1

U

- Unblock soft key 4-6
- unblocking contacts 4-6
- unregistered line, description of 1-12, 5-5
- uppercase characters, entering 1-13
- URLs, dialing 3-2
- URLs, entering 1-12

V

- View Persistency setting 2-14
- voice mail, using 2-24, 3-16
- volume keys, about 1-8
- volume, adjusting 1-8, 2-10

W

- watch buddy setting 2-17, 4-4
- Watcher List 4-4, 4-5

End-User License Agreement for Polycom[®] Software

This End-User License Agreement (“Agreement”) is a legal agreement between you (either an individual or a single entity) and Polycom, B.V for the Polycom Software Product licensed by Polycom B.V in Europe, the Middle East, Africa, and Asia Pacific or Polycom, Inc., for the Polycom Software Product licensed by Polycom, Inc. in the rest of the world (collectively, “Polycom”). The Software Product includes the computer software included herewith and may include associated media, printed materials and online or electronic documentation (“Software Product”). By clicking ‘I agree’ or by installing, copying, or otherwise using the Software Product, you agree to be bound by the terms of this Agreement. If you do not agree to the terms of this Agreement, do not install or use the Software Product, and return it to your place of purchase for a full refund.

The Software Product is protected by copyright laws and international copyright treaties, as well as other intellectual property laws and treaties. The Software Product is licensed (not sold) to you, and its use is subject to the terms of this Agreement.

1. GRANT OF LICENSE.

Subject to the terms of this Agreement, Polycom grants to you a nonexclusive license to install and use the Software Product included with the Polycom product that incorporates or uses the Software Product (the “Product”). You may use the Software Product only in connection with the use of the Product. You are not permitted to lease, rent, distribute or sublicense the Software Product or to use the Software Product in a time-sharing arrangement or in any other unauthorized manner. Further, no license is granted to you in the human readable code of the Software Product (source code). Except as provided below, this License Agreement does not grant you any rights to patents, copyrights, trade secrets, trademarks, or any other rights in respect to the Software Product.

2. DESCRIPTION OF OTHER RIGHTS AND LIMITATIONS.

2.1 Limitations on Reverse Engineering, Decompilation, and Disassembly. You may not reverse engineer, decompile, or disassemble the Software Product, except and only to the extent that such activity is expressly permitted by applicable law notwithstanding this limitation. The Software Product is licensed as a single product. Its component parts may not be separated for use on more than one Product.

2.2 Backup. Except as expressly provided for under this Agreement, you may not copy the Software Product, except, however, you may keep one copy of the Software Product and, if applicable, one copy of any previous version for back-up purposes, only to be used in the event of failure of the original. All copies of the Software Product must be marked with the proprietary notices provided on the original Software Product. You may not reproduce the supporting documentation accompanying the Software Product.

2.3 Modifications. You may not modify, translate, or create derivative works of the Software Product.

2.4 Proprietary Notices. You may not remove or obscure any proprietary notices on or in the Software Product or the supporting documentation.

2.5 Software Transfer. You may permanently transfer all of your rights under this Agreement provided you retain no copies, you transfer all of the Software Product (including all component parts, the media, any printed materials, any upgrades, this Agreement, and, if applicable, the Certificate of Authenticity), and any recipient agrees to the terms of this Agreement. If the Software Product is an upgrade, any transfer must include all prior versions of the Software Product. However, if the Software Product is marked “Not for Resale” or “NFR,” you may not resell it or otherwise transfer it for value.

2.6 Copyright. All title and copyrights in and to the Software Product (including, but not limited to, any images, photographs, animations, video, audio, music, text, and “applets” incorporated into the Software Product), the accompanying printed materials, and any copies of the Software Product are owned by Polycom or its suppliers. The Software Product is protected by copyright laws and international treaty provisions. Title, ownership rights, and intellectual property rights in the Software Product shall remain in Polycom or its suppliers. Title and related rights in the content accessed through the Software Product is the property of such content owner and may be protected by applicable law. This Agreement gives you no rights in such content.

2.7 Confidentiality. The Software Product contains valuable proprietary information and trade secrets of Polycom and its suppliers and you shall protect the confidentiality of, and avoid disclosure and unauthorized use of, the Software Product.

2.8 Dual-Media Software. You may receive the Software Product in more than one medium. Regardless of the type or size of medium you receive, you may use only one medium that is appropriate for your single Product. You may not use or install the other medium on another Product.

2.9 Reservation. Polycom reserves all rights in the Software Product not expressly granted to you in this Agreement.

3. SUPPORT SERVICES.

Polycom may provide you with support services related to the Software Product (“Support Services”). Use of Support Services is governed by the Polycom policies and programs described in the Polycom-provided materials. Any supplemental software code provided to you as part of the Support Services is considered part of the Software Product and is subject to the terms and conditions of this Agreement. With respect to technical information you provide to Polycom as part of the Support Services, Polycom may use such information for its business purposes, including for product support and development. Polycom will not utilize such technical information in a form that personally identifies you.

4. TERMINATION.

Without prejudice to any other rights, Polycom may terminate this Agreement if you fail to comply with any of the terms and conditions of this Agreement. In such event, you must destroy all copies of the Software Product and all of its component parts. You may terminate this Agreement at any time by destroying the Software Product and all of its component parts.

5. UPGRADES.

If the Software Product is labeled as an upgrade, you must be properly licensed to use the software identified by Polycom as being eligible for the upgrade in order to use the Software Product. A Software Product labeled as an upgrade replaces and/or supplements the software that formed the basis for your eligibility for the upgrade. You may use the resulting upgraded Software Product only in accordance with the terms of this Agreement. If the Software Product is an upgrade of a component of package of software programs that you licensed as a single product, the Software Product may be used and transferred only as part of that single Software Product package and may not be separated for use on more than one Product.

6. WARRANTY AND WARRANTY EXCLUSIONS.

6.1 Limited Warranty. Polycom warrants that (a) the Software Product will perform substantially in accordance with the accompanying documentation for a period of ninety (90) from the date of receipt by you, and (b) any Support Services provided by Polycom shall be substantially as described in applicable written materials provided to you by Polycom, and Polycom support engineers will make commercially reasonable efforts to solve any problem issues. Polycom does not warrant that your use of the Software Product will be uninterrupted or error free, or that all defects in the Software Product will be corrected. Polycom’s sole obligation under this express warranty shall be, at Polycom’s option and expense, to

refund the purchase price paid by you for any defective software product which is returned to Polycom with a copy of your receipt, or to replace any defective media with software which substantially conforms to applicable Polycom published specifications. Any replacement Software Product will be warranted for the remainder of the original warranty period or thirty (30) days, whichever is longer.

6.2 Warranties Exclusive. If this Software Product does not operate as warranted above, your sole remedy for breach of that warranty shall be repair, replacement, or refund of the purchase price paid, at Polycom's option. TO THE FULL EXTENT ALLOWED BY LAW, THE FOREGOING WARRANTIES AND REMEDIES ARE EXCLUSIVE AND ARE IN LIEU OF ALL OTHER WARRANTIES, TERMS OR CONDITIONS, EXPRESS OR IMPLIED, EITHER IN FACT OR BY OPERATION OF LAW, STATUTORY OR OTHERWISE, INCLUDING WARRANTIES, TERMS OR CONDITIONS OF MERCHANTABILITY, FITNESS FOR A PARTICULAR PURPOSE, SATISFACTORY QUALITY, CORRESPONDENCE WITH DESCRIPTION, AND NON-INFRINGEMENT, ALL OF WHICH ARE EXPRESSLY DISCLAIMED. POLYCOM NEITHER ASSUMES NOR AUTHORIZES ANY OTHER PERSON TO ASSUME FOR IT ANY OTHER LIABILITY IN CONNECTION WITH THE SALE, INSTALLATION, MAINTENANCE, OR USE OF THIS SOFTWARE PRODUCT.

POLYCOM SHALL NOT BE LIABLE UNDER THIS WARRANTY IF ITS TESTING AND EXAMINATION DISCLOSE THAT THE ALLEGED DEFECT OR MALFUNCTION IN THE SOFTWARE PRODUCT DOES NOT EXIST OR WAS CAUSED BY YOUR OR ANY THIRD PERSON'S MISUSE, NEGLIGENCE, IMPROPER INSTALLATION OR TESTING, UNAUTHORIZED ATTEMPTS TO MODIFY THE PRODUCT, OR ANY OTHER CAUSE BEYOND THE RANGE OF THE INTENDED USE, OR BY ACCIDENT, FIRE, LIGHTNING, POWER CUTS OR OUTAGES, OTHER HAZARDS, OR ACTS OF GOD.

7. LIMITATION OF LIABILITY.

TO THE MAXIMUM EXTENT PERMITTED BY APPLICABLE LAW, IN NO EVENT SHALL POLYCOM OR ITS SUPPLIERS BE LIABLE FOR ANY SPECIAL, INCIDENTAL, INDIRECT, OR CONSEQUENTIAL DAMAGES WHATSOEVER (INCLUDING, WITHOUT LIMITATION, DAMAGES FOR LOSS OF BUSINESS PROFITS, BUSINESS INTERRUPTION, LOSS OF BUSINESS INFORMATION, OR ANY OTHER PECUNIARY LOSS) ARISING OUT OF THE USE OR INABILITY TO USE THE SOFTWARE PRODUCT OR THE PROVISION OF OR FAILURE TO PROVIDE SUPPORT SERVICES, EVEN IF POLYCOM HAS BEEN ADVISED OF THE POSSIBILITY OF SUCH DAMAGES. IN ANY CASE, POLYCOM'S ENTIRE LIABILITY SHALL BE LIMITED TO THE GREATER OF THE AMOUNT ACTUALLY PAID BY YOU FOR THE SOFTWARE PRODUCT OR U.S. \$5.00; PROVIDED, HOWEVER, IF YOU HAVE ENTERED INTO A POLYCOM SUPPORT SERVICES AGREEMENT, POLYCOM'S ENTIRE LIABILITY REGARDING SUPPORT SERVICES SHALL BE GOVERNED BY THE TERMS OF THAT AGREEMENT.

8. DISCLAIMER.

Some countries, states, or provinces do not allow the exclusion or limitation of implied warranties or the limitation of incidental or consequential damages for certain products supplied to consumers, or the limitation of liability for personal injury, so the above limitations and exclusions may be limited in their application to you. When the implied warranties are not allowed to be excluded in their entirety, they will be limited to the duration of the applicable written warranty. This warranty gives you specific legal rights which may vary depending on local law.

9. EXPORT CONTROLS.

The Software Product may not be downloaded or otherwise exported or re-exported (i) into (or to a national or resident of) Cuba, North Korea, Iran, Syria, Sudan, or any other country to which the U.S. has embargoed goods; or (ii) to anyone on the U.S. Treasury Department's List of Specially Designated Nationals or the U.S. Commerce Department's Table of Denial Orders. By downloading or using this Software Product, you are agreeing to the foregoing and you are representing and warranting that you are

not located in, under the control of, or a national or resident of any such country or on any such list. If you obtained this Software Product outside of the United States, you are also agreeing that you will not export or re-export it in violation of the laws of the country in which it was obtained.

10. MISCELLANEOUS.

10.1 Governing Law. This Agreement shall be governed by the laws of the State of California, as such laws are applied to agreements entered into and to be performed entirely within California between California residents, and by the laws of the United States. The United Nations Convention on Contracts for the International Sale of Goods (1980) is hereby excluded in its entirety from application to this Agreement.

10.2 General. This Agreement represents the complete agreement concerning this license and may amended only by a writing executed by both parties. If any provision of this Agreement is held to be unenforceable, such provision shall be reformed only to the extent necessary to make it enforceable.

10.3 Contact. If you have any questions concerning this Agreement, or if you desire to contact Polycom for any reason, please contact the Polycom office serving your country.

10.4 U.S. Government Restricted Rights. The software and documentation provided by Polycom pursuant to this Agreement are "Commercial Items," as the term is defined at 48 C.F.R. §2.101, consisting of "Commercial Computer Software" and "Commercial Computer Software Documentation," as such terms are used in 48 C.F.R. §12.212 or 48 C.F.R. §227.7202, as applicable. Consistent with 48 C.F.R. §12.212 or 48 C.F.R. §§227.7202-1 through 227.7202-4, as applicable, the Commercial Computer Software and Commercial Computer Software Documentation are licensed to United States Government end users (1) only as Commercial Items and (2) with only those rights as are granted to all other users pursuant to the terms of this Agreement.

www.polycom.com

Corporate Headquarters: 4750 Willow Road, Pleasanton, CA 94588,
USA
Phone: 925.924.6000

Israel Office: 94 Derech Em Hamoshavot P.O.B. 3654,
Petach-Tikva 49130, Israel
Phone: +972 3 925 1444
Fax: +972 3 921 1571

Netherlands Office: Tarnspolis Park, Siriusdreef 41, 2132 Wt
Hoofddorp Netherlands
Phone: 31-0-230-2600