



IP Office

5420 + EU24 User's Guide

Contents

The 5420 Telephone	6
Overview of the 5420	6
Call Appearance Keys.....	7
System Features	8
Call Appearance/Function Key Icons	8
Basic Call Handling Features	9
Answer a Call.....	9
Making a Call	9
Clearing a Call	9
Headset Working	10
Speakerphone.....	10
Speed Dial	11
Redial.....	11
Mute.....	11
Hold.....	11
Transfer.....	12
Conference	12
Message	12
Speed Dials.....	13
Overview of Speed Dials.....	13
Using Speed Dials	14
Dialing a Speed Dial Number	14
Deleting a Speed Dial.....	14
Editing a Speed Dial	14
Converting a Call Log Entry to a Speed Dial	14
Adding a New Speed Dial.....	15
Using the Call Log	16
Overview of the Call Log	16
Using the Call Log.....	17
Viewing the Call Log.....	17
Making Calls from the Call Log.....	17
Saving a Call Log Entry to Your Speed Dial List	17
Deleting a Call Log Entry.....	18
Erasing All Logged Calls	18
Setting Which Calls are Logged	18
Changing the 5420 Options	19
Overview of 5420 Options.....	19
Selecting Personalized Options	20
Ring Options.....	20
Adjusting the Display Contrast.....	20
Call Log Setup.....	21
Miscellaneous.....	21
Using Self Test	21
Selecting the Display Mode	21
Default Phone/Erase All Settings.....	21
Language.....	22
Changing Function Key Labels.....	22
Automatic Gain Control (AGC)	22
Function Keys	23
Overview of the Function Keys	23

Display Mode	24
Function Key Programming.....	25
Shorthand Programming Mode	26
Longhand Programming	27
Display Key Features	28
Dial (#).....	28
Group (#).....	28
User (#).....	28
Absnt - Set Absent Text	29
Acct - Account Code Entry (!).....	29
AD - Abbreviated Dial (!)	29
Admin - Self-Administer (!)	29
Apear - Appearance	30
AutCB - Automatic Callback (!).....	30
Busy - Busy	30
BusyH - Busy On Held	30
CFrwd - Call Forwarding All (!).....	31
ClrCW - Clear CW	31
CnfRV - Conference Meet Me	31
Conf+ - Conference Add.....	31
CPark - Call Park (!)	32
CPkUp - Call Pickup (!)	32
CWOFF - Call Waiting Off	32
CWOOn - Call Waiting On	33
CWSus - Call Waiting Suspend.....	33
DCW - Dial CW.....	33
Dir - Directory (!).....	33
Dirct - Dial Direct	34
DNDOn - Do Not Disturb On	34
DNDOf - Do Not Disturb Off	34
DNDX+ - Do Not Disturb Exception Add	34
DNDX- - Do Not Disturb Exception Delete	34
DPkUp - Directed Call Pickup (!).....	35
Drop - Drop (!)	35
DTone - Secondary Dial Tone.....	35
Emrgy - Dial Emergency	35
Flash - Flash Hook (#).....	35
FolTo - Follow Me To	36
FwBNo - Forward On Busy Number.....	36
FwBOn - Forward On Busy On	36
FwBOF - Forward On Busy Off	36
FwdH+ - Forward Hunt Group Calls On	37
FwdH- - Forward Hunt Group Calls Off.....	37
FwdNo - Forward Number	37
FwdOf - Cancel All Forwarding	37
FwNOn - Forward On No Answer On	38
FwNOF - Forward On No Answer Off	38
FwUOn - Forward Unconditional On	38
FwUOf - Forward Unconditional Off	38
GrpPg - Group Paging (!)	38
HdSet - Headset Toggle (!)	39
Here- - Follow Me Here Cancel.....	39
Here+ - Follow Me Here	39
HfAns - Internal Auto-Answer (!)	39
HGEna - Hunt Group Enable.....	40
HGDis - Hunt Group Disable.....	40
HGNS+ - Set Hunt Group Night Service (!).....	40
HGNS- - Clear Hunt Group Night Service.....	40
HGOS+ - Set Hunt Group Out of Service.....	41
HGOS- - Clear Hunt Group Out of Service	41
Hold - Hold Call	41
HoldCW - Hold Call Waiting	41
IAuto - Automatic Intercom.....	41
ICSeq - Set Inside Call Sequence.....	42

IDial - Dial Intercom	42
Inclu - Dial Inclusion	42
Intru - Call Intrude	42
Listn - Call Listen	42
Login - Extn Login	42
Logof - Extn Logout	43
Music - Hold Music	43
NATim - Set No Answer Time	43
OCSeq - Set Outside Call Sequence	43
Page - Page	43
Park - Park (#)	44
Park - Call Park to Other Extension (!)	44
PCall - Priority Call	44
PhyEx - Dial Physical Extension by Number	44
PickA - Call Pickup Any	45
PickG - Call Pickup Group	45
PickM - Call Pickup Members	45
Prog - Abbreviated Dial Program (!)	46
Quota - Clear Quota	46
Queue - Call Queue	46
RBak+ - Ringback When Free	46
RBak - Cancel Ringback When Free	47
RBSeq - Set Ringback Sequence	47
Recor - Call Record	47
Relay - Relay Pulse	47
Rely+ - Relay On	47
Rely- - Relay Off	48
Resum - Resume Call	48
Rtriv - Retrieve Call	48
Ride - Ride Call	48
RngOf - Ringer Off (!)	49
SAC - Send All Calls (!)	49
Spres - AD Suppress (!)	49
Steal - Call Steal	50
SusCW - Suspend CW	50
Suspe - Suspend Call	50
Timer - Timer (!)	51
TmDay - Time of Day (!)	51
Toggl - Toggle Calls	51
VMRB- - Voicemail Ringback Off	51
VMRB+ - Voicemail Ringback On	51
VMCol - Voicemail Collect	52
VMOff - Voicemail Off	52
VMOOn - Voicemail On	52
WUTim - Set Wrap Up Time	52
System Features	53
Introduction	53
Making Calls	53
Answering Calls	53
Call Waiting	54
Call Forwarding	54
Diverting Calls	54
Do Not Disturb	54
Voicemail	55
Default Feature Codes	55
EU24 Expansion Module	56
EU24 Overview	56
Connection	56
Using the EU24 Expansion Module	57
Viewing the Alternate Display	57

Selecting a Call Appearance/Feature Button.....	57
Understanding Call Appearance/Feature Button Status Icons	57
Index.....	58



The 5420 Telephone

Overview of the 5420

This guide covers the use of the Avaya 5420 telephone, running in Key and Lamp mode, on Avaya IP Office telephone systems operating with Level 3.0 software and the 5420 telephone's software running at REL:4.00 or higher (see Using Self Test on page 21). The diagram below shows the main 5420 telephone features.



1. **Display, Call Appearance and Function keys:** Call Appearance Keys allow the user to handle multiple calls and the display shows call information. System functions (allocated by your System Administrator) can also be displayed. See Call Appearance Keys on page 7 and Function Keys on page 23.
2. **Message lamp:** Lit when the user has voicemail messages. Can also be set to flash when the phone is ringing.
3. **Previous/Next Page:** Move through the different pages of the call handling, speed dials and call log screens. Also used to move the cursor during data entry.
4. **Messages:** Access the user's mailbox.
5. **Call Handling Buttons:** See Basic Call Handling Features on page 9.
 - **Hold:** Place call on hold.
 - **Transfer:** Transfer call.
 - **Conference:** Conference held calls.
 - **Drop:** Drop call.
 - **Redial:** Redial last number dialed.
6. **Dial pad:** Standard 12-button pad for dialing telephone numbers.
7. **Volume Controls:** Adjust the speaker, handset, headset, or ringer volume depending on which is currently in use.
8. **Mute:** Turns the microphone on/off. When Mute in use, the associated light is on and the caller cannot hear you.
9. **Headset:** Switches from handset to headset. The light associated with this button turns on when the headset is active.

10.  **Speaker:** Access the speakerphone. The light associated with this button turns on when the speakerphone is active.
11.  **Exit:** Returns you to the main call handling screen.
12.  **Softkeys:** Used to navigate to or initiate certain features, such as Speed Dial or Call Log, as well as control certain actions within the features. These keys correspond to the text prompts in the display screen immediately above them. See Speed Dials on page 13, Using the Call Log on page 16, Changing the 5420 Options on page 19 and **Error! Reference source not found.** on page **Error! Bookmark not defined.**

Call Appearance Keys

Normally, the first page of the main call handling screen contains three keys set as 'call appearance' keys. These are allocated to you by your System Administrator and are indicated as **a=**, **b=** and **c=**.

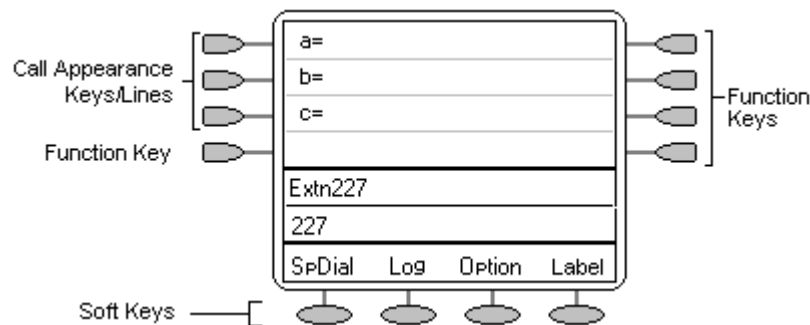

Your System Administrator can change a call appearance key with:

- **A Bridged Appearance**
A bridged appearance key matches the status and operation of the Call Appearance Key on a pre-defined colleague's telephone. Hence, you can pick-up, make and receive calls on behalf of your colleague.
- **A Line Appearance**
An IP Office exchange line (but not IP lines) can be allocated to you such that the status of that line is displayed and you can use the line appearance key to make and receive calls.
- **Call Coverage Appearance**
A call coverage appearance key alerts you when a pre-defined colleague is receiving a call. The covered user does not need to be using call appearance keys. Hence, you can pick-up calls on behalf of your colleague.

All of the above can only be allocated to you by your System Administrator.

For details of Bridged, Line and Call Coverage Appearance Keys set-up and their operation, refer the *IP Office Key and Lamp Operation* manual.

CAUTIONS:

1. Having **more than two** Call Appearance keys is very useful. When holding a call you can answer/make another call and then switch between calls or transfer or conference. If you are set to receive *call waiting* indication, the waiting call is shown against the next call appearance key.
2. Although the System Administrator can replace the Call Appearance Keys with:
 - A Bridged Appearance
 - A Line Appearance
 - Call Coverage Appearance
 - System Features
 This would severely restrict the use of features such as conference and transfer.

It is for these reasons that it is **strongly recommended** that all Call Appearance keys **remain at their default settings.**















System Features

System Features **can only be** set against soft Function Keys by your System Administrator. However, your System Administrator may allocate you two 'self administrator' features that will enable you to add System Features to your soft Function Keys. Refer to Function Keys on page 23 for details of the System Feature that **can only be allocated to you** by your System Administrator.

In addition, there are a number of System Features that you can always access **yourself** by the use of short codes. Refer to System Features on page 53 for details of System Features that **you can always access** yourself by dialing short codes, e.g. *17 to listen to your VoiceMail messages.

Call Appearance/Function Key Icons

The icons displayed against the Call Appearance/Feature Keys allow you to determine the status (for example, on Hold) of each call. Icons also indicate whether a feature has been activated for a particular button.

- **Incoming Call:**  A  symbol next to a call appearance key indicates an incoming call. Pressing the adjacent   key answers the call and puts any other current call on hold.
- **Connected:**  A  symbol next to a call appearance key indicates that it is the currently connected call. The caller's telephone number (if available) is also shown. Pressing the adjacent   key puts the call on hold. An H is also shown on the display.
- **On Hold:**  A  symbol next to a call appearance key indicate a call on hold. Pressing the adjacent   key takes the call off hold and puts any other current call on hold.
- **Function Active:**  or  The button to the left or right of the function key is active.

Basic Call Handling Features

Answer a Call

When a call arrives at your 5420 telephone, you hear a ringing tone and a blinking bell icon appears on the associated call appearance.

To answer an incoming call:





Do one of the following:

- If you are not active on another call, answer the call using your handset, headset, or speakerphone (see Speakerphone on page 10).
- If you are active on a call already, place the active call on hold (Hold on page 11), and then answer the incoming call.
- If the call appearance for the ringing call is not displayed on the current screen page, use  to return to the first page of the Home screen. When you locate the call appearance for the ringing call, press the corresponding call appearance button.

Making a Call



You can make calls from the 5420 telephone using a variety of methods as follows:

To manually make a call:

1. Dial the required number on the key pad (remember to include the required access code (for example, 9) for an outside line) and listen to the progress of the call.
2. Adjust speakerphone volume as necessary.
 - To change the volume use the  and  buttons. The display shows the volume level. (There are eight volume levels.)
3. If the call is not answered, you can clear the call by pressing  **Speaker** or  **Drop**
or
4. When the call is answered, either speak or pick up the handset and speak to the called party.

To automatically make a call:

Do any of the following:

- Press  **Redial** and a call appearance key  to have the 5420 telephone dial the last number that you dialed.
or
- Access the Call Log and initiate a call to a specific entry.
See Using the Call Log on page 17.
or
- Access the Speed Dial List in your personal directory and initiate a call to a specific entry. See Speed Dials on page 13.
- When the call is answered, either speak or pick up the handset and speak to the called party.

Clearing a Call

To clear an established call either:

1. Replace the handset
or
2. Press  **Drop**. You will hear dial tone, unless you are in 'call centre mode' when you will then hear silence (see Display Mode on page 24).

Headset Working

When a headset is to be used on your 5420, it must be plugged in to the headset socket on the base of your 5420 telephone. To activate the headset and switch off the handset, press  **Headset**. The lamp beside the button is illuminated when headset working is activated.

To answer an incoming call:

1. Press the call appearance key next to the flashing bell icon ():

To clear a headset call:



1. Press  **Drop**.

To manually make a call:

1. Dial the number (remember to include the required access code (for example, **9**) for an outside line) and listen to the progress of the call.

To automatically make a call:





Do any of the following:

- Press  **Redial** and a call appearance key  to have the 5420 telephone dial the last number that you dialed.
- or
- Access the Call Log and initiate a call to a specific entry. See Using the Call Log on page 17.
- or
- Access the Speed Dial List in your personal directory and initiate a call to a specific entry. See Speed Dials on page 13.
- When the call is answered, speak to the called party.

Speakerphone

The two-way built-in speakerphone allows you to make and answer calls without lifting your handset. Keep in mind that two-way speakerphones may not operate satisfactorily in every environment (such as in very noisy locations) and that they operate best when you speak directly to them.

To make or answer a call without lifting the handset, or to use the speakerphone with any feature:

1. Press  **Speaker**. The LED beside the  **Speaker** button illuminates.
2. Make or answer the call, or access the selected feature.
3. Adjust the speakerphone volume if necessary.
 - To change the volume use the  and  buttons. The display shows the volume level. (There are eight volume levels.)

To change from the speakerphone to handset (or headset if fitted)

1. Pick up the handset (or press  **Headset**) and talk.

To change from the handset to the speakerphone

1. Press  **Speaker**.
2. Hang up the handset.



To end a speakerphone call

1. Press  **Speaker** again.

Speed Dial

The Speed Dial feature allows you to have the 5420 telephone automatically dial calls to telephone numbers stored in your personal directory (maximum of 104). See Speed Dials on page 13.

To make a call to a personal directory entry using the Speed Dial feature:



1. Press the  **SpDial** softkey. The Speed Dial screen is displayed.
2. Press the button next to the entry you want to call.
3. If the entry you want is not displayed, use  and  to cycle through the entries **or** key the first letter of the required name to jump to the page with a matching entry.
4. The 5420 telephone dials the number for you.

Redial

The Redial (or Last Number Dialed) feature automatically redials a previously dialed extension or outside number (up to 24 digits). Your 5420 will store the up to ten of the last numbers dialed.

Note: If you have dialed the same number twice in succession, it will only have one appearance in the redial list.



To redial previously dialed number:

1. Press  **Redial**. Use  and  to step through the entries. When you have located the required number, press the associated key.

Mute

During an active call, the Mute feature prevents the party with whom you are speaking from hearing you. This feature is most commonly used in conjunction with the Speakerphone, but can be used to hold an off-line conversation at any time during a call.





Preventing the other person on the line from hearing you:

1. Press  **Mute**.
 - The other party cannot hear you. The indicator next to the **Mute** button lights when **Mute** is active.
2. To reinstate two-way conversation, press  **Mute** again.

Hold



If, with a call in progress, a second call arrives and is shown against a Call Appearance key, you can then Hold the first call and answer the second call.

To put an existing call on hold:

1. Press  **Hold** or the Call Appearance button with the  symbol against it. The symbol changes to ; showing that the line is on hold.
2. Answer the second call by pressing the Call Appearance button with the  symbol against it. The symbol changes to ; showing that the line is connected.

To return to the held call:

1. If you have a call in progress, then first put that call on hold as above.
2. To retrieve a held call, simply press the Call Appearance button with the  against it.







Note: After a pre-set time (defined by your System Administrator), you are reminded that you have a call on hold by the  hold icon changing for a few moments to  and the phone ringing.

Also see Transfer on page 12.



Transfer

The Transfer feature allows you to transfer a call from your telephone to another extension or outside number.

To transfer the current call to another extension

1. With a call in progress, press  **Transfer** or  **Hold**.
2. When you hear dial tone, dial the number to which the call is to be transferred.
3. Do one of the following:
 - To transfer the call without announcing it, either hang up or press  **Transfer** again. The transfer is complete. If the transferred call is not answered within a preset time, it is returned to you.
 - To announce the call before transferring it, wait for the called party to answer. If the called party is willing to accept the call, press  **Transfer** again to complete the transfer.
If the called party does not wish to accept the call, press  **Drop**. You can return to the held call by pressing its call appearance button.
 - If the line is busy or if there is no answer, press  **Drop**.
You can return to the held call by pressing its call appearance button.

To transfer a new call to a held call using Conference:



1. With a call in progress and you wish to make an enquiry call or another call arrives, press  **Hold**. Make or answer the second call. The second call requires to be transferred to the first held call.
2. To transfer the new call to the held call, press  **Conference** and then  **Drop**. The transfer is complete.

Conference

The Conference feature allows you to conference other parties (including yourself) into a call.

- Notes:**
1. The number of parties allowed in a conference is controlled by your telephone system.
 2. Two Call Appearance keys are required for the conference feature.

To add another party to a call:

1. Press  **Conference**.
2. Dial the number of the person you want to add to the call.
3. Wait for an answer.
If the called party does not answer or does not want to join the conference, press  **Drop**.
4. To add the person to the call, press  **Conference** again.
You can return to the held call by pressing its call appearance button.
5. Repeat steps 1 through 4 for additional conference connections.

To add a held call(s) to an active call:

1. Press  **Conference**.
2. All held calls are added to the conference.

To leave a conference call:

1. To leave a conference, press  **Drop**.

Message

Your Message lamp turns on when a caller has left a message for you.

Press the  **Messages** button to retrieve your messages and follow the prompts.

Speed Dials

Overview of Speed Dials

The 5420 can store up to 104 personal speed dials. The list of these speed dials is accessed by pressing **SpDial**. If **SpDial** is not shown, press **Exit** to exit the current screen.

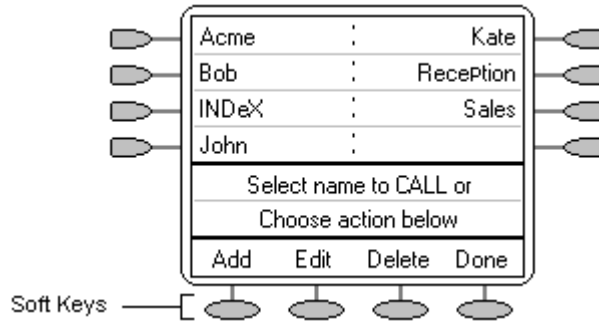

- The speed dial list is sorted alphabetically.
- Press **Left Arrow** and **Right Arrow** to move between pages **or** key the first letter of the required name to jump to the page with a matching entry.
- Press the **Left Arrow** or **Right Arrow** next to an entry to call the associated number.
- Use the **Soft Keys** to perform other actions.

Pressing **Add** or **Edit** gives access to the details of a particular speed dial.

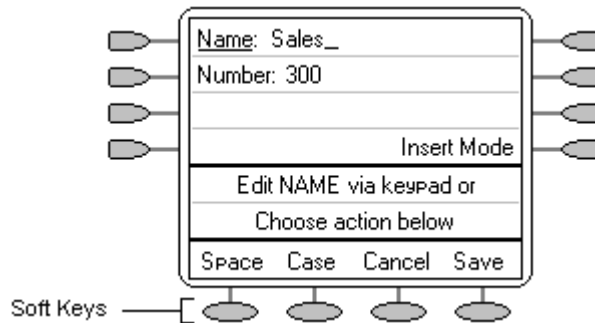





Note: Speed dials can be used for any numbers that can be manually dialed from the extension. Where a dialing prefix is required (for example an external line access digit; usually 9) then that prefix must be part of the speed dial number.





Using Speed Dials

Dialing a Speed Dial Number





You can use the speed dial directory to make a call with the handset on hook or off hook.

1. Press **SpDial**. If **SpDial** is not shown, press  to exit the current screen.
2. Press either the  or  key to display different pages of speed dials **or** key the first letter of the required name to jump to the page with a matching entry.
3. When the required entry is displayed, press the adjacent  or  key. The number is automatically dialed for you.

Deleting a Speed Dial

1. Press **SpDial**. If **SpDial** is not shown, press  to exit the current screen.
2. Press **Delete**.
3. Select the speed dial entry you want to delete.
 - Press either the  or  key to display different pages of speed dials **or** key the first letter of the required name to jump to the page with a matching entry.
4. When the required entry is displayed, press the adjacent  or  key. A request for confirmation will appear.
5. Press **Yes** to delete the entry or **Cancel** to exit without deleting.
6. Select another entry to delete or press **Done** to return to the speed dial list.

Editing a Speed Dial

1. Press **SpDial**. If **SpDial** is not shown, press  to exit the current screen.
2. Press **Edit**.
3. Select the speed dial entry you want to edit.
 - Press either the  or  key to display different pages of speed dials **or** key the first letter of the required name to jump to the page with a matching entry.
4. When the required entry is displayed, press the adjacent  or  key.
5. Edit the speed dial using the same methods as for adding a new speed dial. See Adding a New Speed Dial on page 15.
6. After saving or cancelling any changes you will be returned to the speed dial selection list. Select another speed dial to edit or press **Done** to return to the speed dial list.

Converting a Call Log Entry to a Speed Dial

You can create a new speed dial from a call log entry. See Saving a Call Log Entry to Your Speed Dial List on page 17. This process will start the normal speed entry screen but pre-filled with the name and number from the call log entry.

Adding a New Speed Dial

1. Press **SpDial**. If **SpDial** is not shown, press **Exit** to exit the current screen.
 - Press **Add**. If a message stating that the speed dial list is full appears, you must first delete an existing entry before adding any new entry. See Deleting a Speed Dial on page 14.

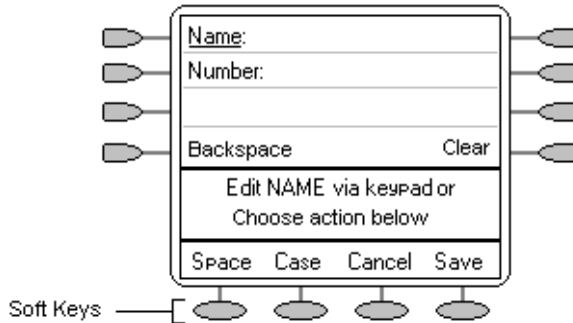

You can switch between **Name** and **Number** entry by pressing the key next to the item you want to edit. The options also change accordingly.

2. With **Name** selected, begin entering text using the telephone keypad. Each key is marked with the letters and number it provides. You may have to press the key more than once depending on the character you require.
 - For example, the key **2** is also marked as **A**, **B** and **C**. To enter a **C**, press **2** until a **C** is displayed.
 - If the next character you want to enter is on the same key, press **Right Arrow** to move the cursor right and then enter the character.
 - By default the first letter is entered in upper-case and the phone then switches to lower-case entry mode. To change the case of the current character press **Case**.
 - To enter a space press **Space**.
 - If you make a mistake, use **Backspace** to delete the character to the left of the cursor.
 - If you have made a mistake in the middle of a character string and do not wish to backspace and re-enter all the characters, use the **Left Arrow** key to step back to one character before the point where you wish to edit. Either insert the new character or press **Backspace** to delete the character to the left of the cursor.
 - Pressing the ***** key once enters a . (period) or twice a *. To enter more than one * or period, press **Right Arrow** to move the cursor right and then enter the character.
 - Pressing the **#** key once enters a - (dash) or twice a #. To enter more than one # or dash, press **Right Arrow** to move the cursor right and then enter the character.
3. When the name is set as required, select **Number**.
4. Enter the number required using the dialing keypad. For external numbers remember to enter any external dialing prefix required (9 say).
 - To enter a hyphen, press **Hyphen**. This does not affect the number dialed but may help make numbers more readable.
 - To enter a 1.5 second pause, press **Pause**. This will appear as a , (comma) character in the telephone number.
 - Use either the **Left Arrow** or **Right Arrow** key to move the cursor left or right.
 - If you make a mistake, use **Backspace** to delete the number to the left of the cursor.
5. Do one of the following:
 - To save the speed dial and return to the speed dial list, press **Save**.
 - To return to the speed dial list without saving the changes press **Cancel**.
 - To return to the call handling screen without saving changes press **Exit**.

Using the Call Log

Overview of the Call Log

The 5420 maintains a call log, accessed by pressing **Log**.

This log can store up to 100 entries. These can be a mixture of incoming answered calls, incoming unanswered calls and outgoing calls.

You can select which types of calls are included in the log. You can also use call log entries to make return calls or convert the entry into a speed dial for future use.



WARNING: Calls that are made using pin codes and other information will appear in the call log. Either *Logging of outgoing calls* should be switched off or those call logs removed manually. See Setting Which Calls are Logged on page 18.

- Notes:**
1. Only outgoing calls made using the dial pad or a **SpDial** entry are logged.
 2. Call log entries are lost if the 5420 is disconnected from the IP Office.

When **Log** is pressed a screen similar to the following is displayed:

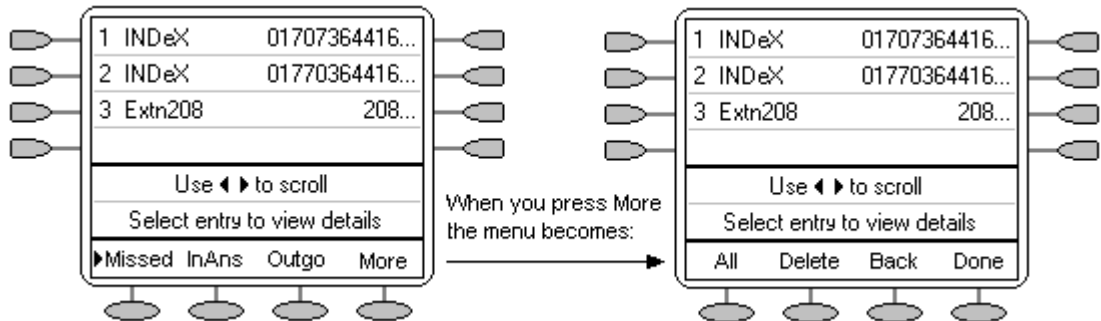

- **Missed** calls are displayed first. You can select from **InAns** or **Outgo**. Alternatively, press **More** and select **All** to display all three options.
- Logged calls are shown with the most recent first.
- The name of the called or calling party is shown if available.
- The number of the called or calling party is shown.
- Press either the or key to display further pages of entries.
- Pressing the or key next to a log entry display further details of that particular call.

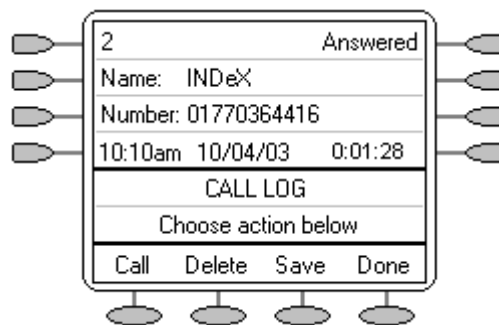











- The number of the log entry.
- The type of log entry, i.e. **Answered**, **Un-answered** or **Outgoing**.
- The name of the called or calling party is shown (if available).
- The number of the called or calling party is shown.
- The date and time of the call. (And for InAns/Outgo, the duration of the call.)
- Press either the or key to display the previous or next logged call.
- The keys provide a number of actions.

Also see Making Calls from the Call Log on page 17, Saving a Call Log Entry to Your Speed Dial List on page 17, Viewing the Call Log on page 17 and Deleting a Call Log Entry on page 18.









Using the Call Log

You can make calls directly from the call log. Whilst in the call log you can still make a call by going off-hook, pressing  **Speaker** and dialing a new call. Similarly, you can still receive calls and handle them using the dial pad key functions.









Viewing the Call Log

1. Press  **Log**. If  **Log** is not shown, press any  **Soft Key**.
2. At default, **Missed** calls are displayed first. You can select from **InAns** or **Outgo**. Alternatively, press **More** and select **All** to display all three options. To return to **Missed** or **InAns** or **Outg**, press **Back** and make your selection.
3. Press  and  to display different pages of log entries.
 - To exit the call log and return to the previous screen press  **Done**.
 - To exit the call log and return to the call handling screen press  **Exit**.
 - To view the details of a particular log entry, press the  or  key next to the entry.
3. Press  **Done** to return to the previous screen.

Making Calls from the Call Log

1. Press  **Log**. If  **Log** is not shown, press any  **Soft Key**.
2. At default, **Missed** calls are displayed first. You can select from **InAns** or **Outgo**. Alternatively, press **More** and select **All** to display all three options. To return to **Missed** or **InAns** or **Outg**, press **Back** and make your selection.
3. Press  and  to display different pages of log entries.
4. When you locate the entry you want to call, press the  or  key next to the entry.
5. Press  **Call** make the call.
 - If the number shown is external but doesn't include the external dialing prefix used by your telephone system, go off-hook, dial the prefix and then press  **Call**.

Saving a Call Log Entry to Your Speed Dial List

1. Press  **Log**. If  **Log** is not shown, press any  **Soft Key**.
2. At default, **Missed** calls are displayed first. You can select from **InAns** or **Outgo**. Alternatively, press **More** and select **All** to display all three options. To return to **Missed** or **InAns** or **Outg**, press **Back** and make your selection.
3. Press  and  to display different pages of log entries.
4. When you locate the entry you want to call, press the  or  key next to the entry.
5. Press  **Save**. The speed dial editing screen appears, pre-filled with the details from the call log entry. See Adding a New Speed Dial on page 15.

Deleting a Call Log Entry

1. Press **Log**. If **Log** is not shown, press any **Soft Key**.
2. At default, **Missed** calls are displayed first. You can select from **InAns** or **Outgo**. Alternatively, press **More** and select **All** to display all three options. To return to **Missed** or **InAns** or **Outg**, press **Back** and make your selection.
3. Press **◀** and **▶** to display different pages of log entries.
4. When you locate the entry you want to call, press the **☐** or **☐** key next to the entry.
5. Press **Delete** and **Done**. The entry is deleted from the Call Log and the details of the next call are shown.
6. To exit the call log and return to the call handling screen press **☐** **Exit**.

Erasing All Logged Calls

Loss of power to the 5420 phone will cause all call log entries to be deleted.

The Erase All option deletes the calls you have selected to log (see Setting Which Calls are Logged on page 18).

Caution: This action also deletes all speed dial entries and phone personalization options. See Default Phone/Erase All Settings on page 21.

1. Press **Log** followed by **More**.
2. Press **Delete**. You are presented with a message asking you to confirm that you want to delete all entries.
3. Press **Erase** to remove all logged entries

Setting Which Calls are Logged

Caution: If you change these settings, any call details already in the call log that no longer match the selection made are deleted.

1. Press **Option**. If **Option** is not shown, press **☐** to exit the current screen.
2. Press **Log Setup**. A menu showing **Answered**, **Un-Answered** and **Outgoing**, with their current settings, is displayed.
3. To toggle a particular setting between **Yes** or **No**, press the **☐** key next to it. Alternatively, press the **☐** key next to a call type to underline its current setting and then press **Yes/No** to change the value of the currently underlined setting.
4. Do one of the following:
 - Note:** If you press **Save** after changing the settings, any existing call log entries that do not match the call types selected are deleted from the call log.
 - To save the settings and return to the options menu, press **Save**. You will hear a confirmation tone.
 - To return to the **Options** menu without saving any changes, press **Cancel**.
 - To return to the call handling screen without saving any changes, press **☐** **Exit**.



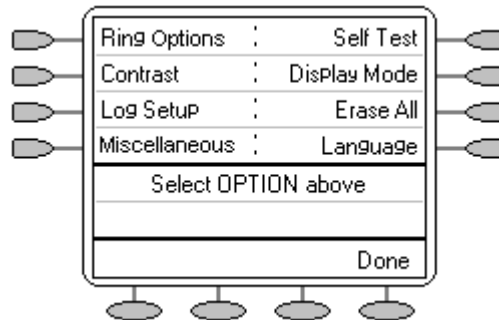

Changing the 5420 Options

Overview of 5420 Options

The options menus are accessed by pressing  **Option**. These menus allow you to adjust a number of 5420 features.



To select an option:

1. Press the  or  next to it
2. The  key actions change according to the current available actions.
3. To exit and return to the normal call handling screen press  **Exit**.
4. Whilst in the options menus, you can still make and receive calls using the telephone keypad controls.

The options are:

- **Ring Options:**
Sets the:
 - The ringing used by your 5420.
 - Toggles the message lamp on/off to show when you have an incoming call.
 - Toggles the 'Show Phone Screen' option on or off.
 See Ring Options on page 20.
- **Contrast:**
Adjust the display contrast.
See Adjusting the Display Contrast on page 20.
- **Log Setup:**
Configure which calls appear in the call log.
See Setting Which Calls are Logged on page 18.
- **Miscellaneous:**
Enables you to select to remain in your Speed Dial Menu during call handling.
- **Self Test:**
Test the phone.
See Using Self Test on page 21.
- **Display Mode:**
Select the order in which functions are shown against display keys.
See Display Mode on page 24.
- **Erase ...:**
Reset the telephone to its default settings.
See Default Phone/Eraser All Settings on page 21.
- **Language:**
Select the phone's display language.
See Language on page 22.

Press  to display:

- **Handset AGC/Headset AGC:**
Switch handset/headset automatic gain control on/off.
See Automatic Gain Control (AGC) on page 22.

Selecting Personalized Options









Ring Options

The Ring Options menus allows you to:



- Choose a personalized ringing pattern for your telephone.
Note: If you receive a call while selecting a ring pattern, you are automatically returned to the call handling screen.
- Set the message lamp to flash when you receive a call.
- Set the telephone to revert to the call handling screen when you are setting up/using Speed Dial, Call Log, etc.

To change the ring pattern:



You can choose from among eight different ring patterns. This alters the tone and style of ringing used by the 5420, e.g. the number of rings will still vary according to the type of call.

1. Press  **Option**.
2. Press  **Ring Options** followed by  **Ring Pattern**. A menu with the current ring pattern appears.
3. To select a ringing pattern use either the  or  keys or press a dial pad key between **1** and **8**. You will hear the selected ringing pattern.
4. To hear the ringing pattern again press  **Play** or repress the dial pad key.
 - When you have selected a ringing pattern, press  **Save**. You will hear a confirmation tone and be returned to the options menu.
 - If you want to return to the options menu without changing the ring pattern, press  **Cancel**.

To set the Flash Message Lamp:







1. Press  **Option**.
2. Press  **Ring Options** and set **Flash Message Lamp** to **Yes** or **No**.
When set to **Yes** the Message lamp will flash when you receive a call.
 - Changing this option does not affect the voicemail visual indicator feature.

To set the Show Phone Screen:

1. Press  **Option**.
2. Press  **Ring Options** and set **Show Phone Screen** to **Yes** or **No**.
If set to **Yes** then, when you are setting up/using Speed Dial, Call Log, etc, you are automatically returned to the call handling screen when you receive a call.

Adjusting the Display Contrast

You can adjust the contrast level on the telephone display. You can choose from among fifteen levels of contrast.

1. Press  **Option**
2. Press  **Contrast**. A menu with the current contrast setting appears.
3. Use either the  or  key to adjust the level of contrast.
4. When the contrast is set as required, either:
 - Return to the options menu by pressing  **Done**.
 - Return to the call handling screen by pressing .

Call Log Setup



Through the **Option** menu you can specify which types of calls should be included in the 5420's call log. See Setting Which Calls are Logged on page 18.

Miscellaneous

This option only contains one menu item: **Stay in Speed Dial**.





When set to **Yes** and you access your personal Speed Dial list (see Using Speed Dials on page 14) the menu will remain displayed regardless of any calls made or received.





To display the call handling screen at any time, press  **Exit**.

1. Press  **Option**.
2. Press  **Miscellaneous** and set **Stay in Speed Dial** to **Yes**.

Using Self Test

Self test can be used to display information about the phone and to check operation of the lamps and display. The information may be required by a telephone system maintainer.

3. Press  **Option**. If  **Option** is not shown, press any  **Soft Key**.
4. Press  **Self Test**. A screen of information appears.









Caution: In the top row, the centre of the display should show **REL:4.00** or higher. If not the telephone's software needs to be upgraded. Consult your system Administrator.
5. Press and hold the  **Test** key. The screen lines should all go black and all the phone lamps should come on. If they do not consult your system Administrator.
6. Release the  **Test** key and do one of the following:
 - To return to the options menu, press  **Done**.
 - To return to the call handling screen, press  **Exit**.

Selecting the Display Mode

See Display Mode on page 24.

Default Phone/Erase All Settings

The Erase All option allows you to reset all personalized settings entered through the 5420's Option menus (except contrast level). It also deletes all entries in the phones Call Log and Speed Dial lists.







1. Press  **Option**.
2. Press  **Erase** A menu is displayed giving you the option to erase: Speed Dial, Call Log, User Labels, Options, Language or All.
3. If you do not want to erase, do one of the following:
 - To return to the options menu without erasing, press  **Cancel**.
 - To return to the call handling screen without erasing, press  .
4. To continue with erasing, select from Speed Dial, Call Log, User Labels, Options, Language or All and press  **Erase**. You will be asked to confirm the action.
 - If you want to erase the settings selected, press  **Erase** again.
 - To return to the options menu without erasing, press  **Cancel**.
 - To return to the call handling screen without erasing, press  .

Language

When the 5420 telephone is first installed, it is set to display screen text in English. You can select the language that you would prefer from the following:

English, German (Deutsch), French (Français), Spanish (Español), Italian (Italiano), Dutch (Nederlands), Portuguese (Português) or Japanese (Katakana characters).

Note: This does not alter your user language setting on the telephone system.

1. Press  **Option**.
2. Press  **Language**. A menu listing the available languages appears, with the current language underlined.
3. Press the  or  key next to the language required. The screen text changes to the language selected.
4. Do one of the following:
 - To save the settings and return to the options menu, press  **Save**. You will hear a confirmation tone.
 - To return to the options menu without saving any changes, press  **Cancel**.
 - To return to the call handling screen without saving any changes, press .









Changing Function Key Labels

This function is currently not supported on IP Office.

Automatic Gain Control (AGC)



Automatic Gain Control (AGC) raises the volume when a caller is speaking quietly and lowers the volume when the caller is loud. The 5420 supports AGC for both the handset and the headset (if connected).

Note: If the ambient background noise in the office is too high, this can affect the AGC settings. Hence it is advisable in this type of environment to switch AGC off.

1. Press  **Option**.
2. Press the  key. A menu listing the current AGC settings for the handset, headset or speaker appears.
3. To toggle a particular setting between **Yes** or **No**, press the  key next to it. Alternatively, press the  key next to **Handset**, **Headset** or **Speaker** to underline its current setting and then press  **Yes/No** to change the value of the currently underlined setting.
4. Do one of the following:
 - To save the settings and return to the options menu, press  **Save**. You will hear a confirmation tone.
 - To return to the options menu without saving any changes, press  **Cancel**.
 - To return to the call handling screen without saving any changes, press .



Function Keys



Overview of the Function Keys

Both the ,  Function Keys and  Soft Keys can be used to access a range of system features. The display adjacent to the key shows the feature name.



Some of these features are default features supported by all 5420 telephones (e.g. **SpDial**, **Log**, **Option** and **Label** on the Soft Keys) and are always available. Others are system features that **can only be programmed by the System Administrator** for Function Keys. See Function Key Programming on page 25.

In addition, there are a number of System Features that you can always **access yourself** by the use of short codes. Refer to System Features on page 53 for details of System Features that **you can always access** yourself by dialing short codes, e.g. *17 to listen to your VoiceMail messages.

The main screen has three pages. This means that the eight  and  Function Keys on each page could be used for up to 24 features. However, it is **strongly recommended** that all three Call Appearance keys **remain at their default settings**. Hence, there are 21 soft Function Keys that can be allocated to system features.

To move between pages use the  and  keys.

In the following example:

- The first three keys have been set (default setting) as call appearance lines. See Call Appearance Keys on page 7.
- Key 4 has been set to access the **Admin** programmable functions. See Function Key Programming on page 25.
- Key 5 has been set to monitor system park slot 1. The **◆** indicates a call is currently parked in slot 1 by the user and when parked in a slot by other users, the label is underlined. See Park - Park (#) on page 44.
- Key 7 has been set to the **SAC** (Send All Calls) function. See SAC - Send All Calls (!) on page 49.
- Key 8 has been set to **VMOn**, a function which toggle use of the user's voicemail mailbox on/off. The **◀** indicates that this function is currently on. See VMOn - Voicemail On on page 52.
- Pressing either  or  will display the other two pages of programmed functions set for this phone.

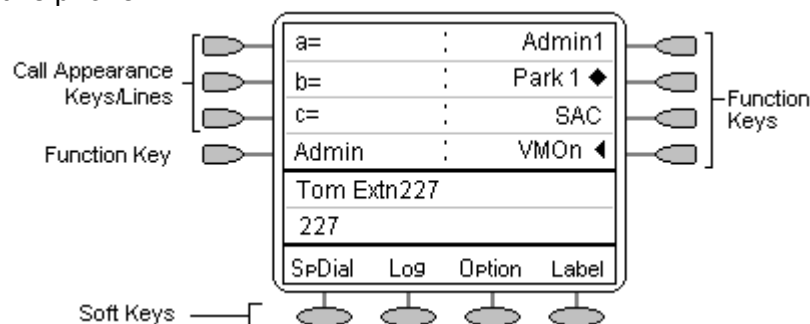

Changing the labels of the Function Keys:

You can personalize the Function Key labels. E.g. you can change **SAC** to **Send All** for instance. See **Error! Reference source not found.** on page **Error! Bookmark not defined.** on page.



Programming Your Own Features:

If the phone has been setup with either or both the **Admin** and **Admin1** features assigned to display keys, you can select and program your own feature choices against other keys. See Function Key Programming on page 25.

Display Mode

The 5420 telephone has two display modes. These control the order in which features are assigned to the display keys. The modes are:



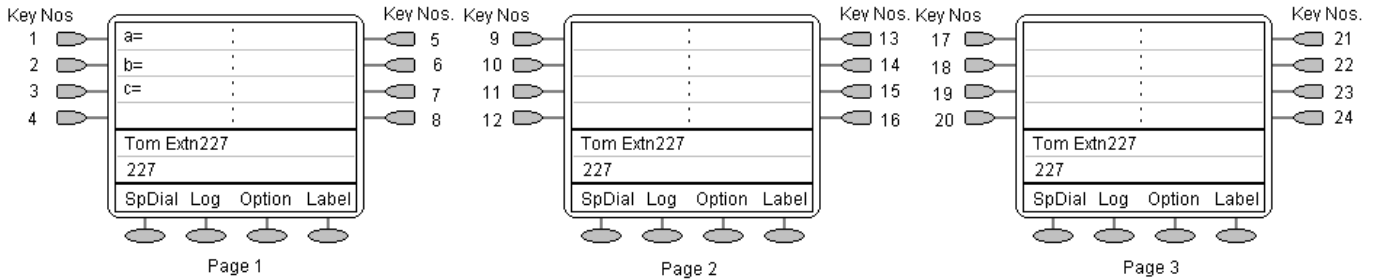

- **Normal Mode:**

In this mode the 3 pages of  and  keys are ordered sequentially.

The  keys at the base of each page provide the **SpDial**, **Log**, **Option** and **Label** options.







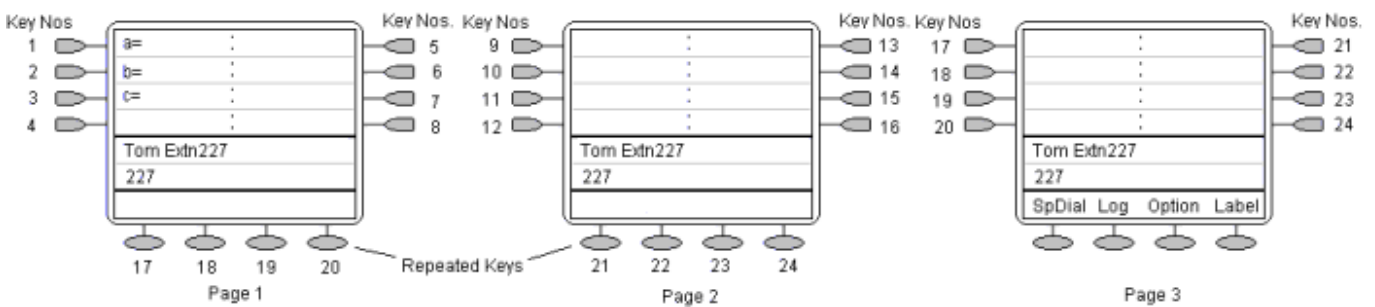



- **Call Center Mode:**

In this mode some of the  and  key features are repeated against the  keys on the first two screen pages. The  keys for **SpDial**, **Log** and **Option** are only shown on the third screen page.



To change the Display Mode:

1. Press  **Option**. If  **Option** is not shown, press  to exit the current screen.
2. Press  **Display Mode**. A menu showing the current setting appears.
3. To change the current setting, either press the  key next to the setting or press  **Yes/No**.
4. Do one of the following:
 - To save the settings and return to the options menu, press  **Save**. You will hear a confirmation tone.
 - To return to the options menu without saving any changes, press  **Cancel**.
 - To return to the call handling screen without saving any changes, press  **Exit**.

Function Key Programming

If any one of the keys on the telephone is programmed with an **Admin** or **Admin 1** feature, it allows you to program further features against other function keys. Both **Admin** and **Admin1** are allocated to your function keys by your System Administrator and would appear on a menu screen that is similar to the following:

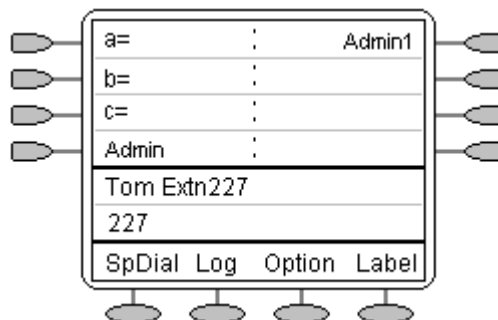

The two tables below list the user programmable features available for **Admin** and **Admin1** respectively. For full details of how each feature works see Display Key Features on page 28.

Admin: The programmable functions available via an **Admin** key.

Name	Description	Toggles	Data
Acct	Account Code Entry	No	Optional
AD	Abbreviated Dial	No	Yes
Admin	Self-Administer	No	No
AutCB	Automatic Callback	Yes	No
CFrwd	Call Forwarding All	Yes	Optional
CPark	Call Park	Yes	Optional
CPkUp	Call Pickup	No	No
Dir	Directory	No	No
DPkUp	Directed Call Pickup	No	Yes
Drop	Drop	No	No
GrpPg	Group Paging	No	Yes
HdSet	Headset Toggle	Yes	No
HfAns	Internal Auto-Answer	Yes	No
HGNS+	Set Hunt Group Night Service	Yes	Yes
Park	Call Park to Other Extension	No	Yes
Prog	Abbreviate Dial Program	No	Yes
RngOf	Ringer Off	Yes	No
SAC	Send All Calls	Yes	No
Spres	AD Suppress	Yes	No
Timer	Timer	Yes	No
TmDay	Time of Day	Yes	No

In addition to the above, there is a key labeled **Exlp?** This key enables you to change the display from the shorthand version displayed at default to a longhand version of your own. See Shorthand Programming Mode on page 26 and Longhand Programming on page 27 respectively.

Admin1: The programmable functions available via an **Admin 1** key.

Name	Description	Toggles	Data
Park	Park	No	Yes
<User>	User	No	Yes
<Group>	Group	No	Yes
<Number>	Dial	No	Yes
Flash	Hook Flash	No	No

Shorthand Programming Mode

1. Press **Admin** or **Admin 1**. See Function Key Programming on page 25.
2. The **Admin** or **Admin1** menu appears as follows:

Admin Pages

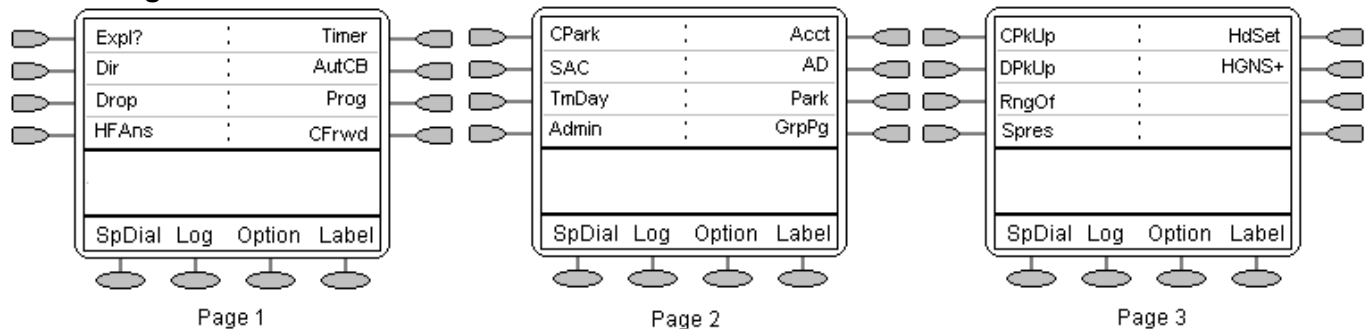

With the exception of **Expl?**, the names shown are the features that you can assign to soft keys. When **Admin** has been selected you can display the full name of the feature by pressing **Expl?**. See Longhand Programming on page 27.

Admin1 Page

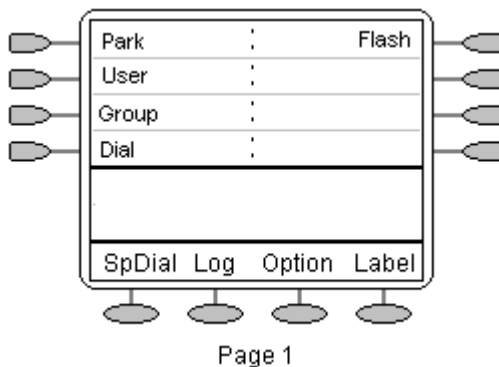

Similarly, when **Admin1** is pressed, you can assign any one of the functions shown to a soft key.

3. On the **Admin** pages, use the **Left** or **Right** keys to move through the list of features.
4. When the function required is shown, press the **Enter** key adjacent to its name.
5. If the function requires some data to be entered, **[]** is shown at the bottom of the display. Enter the data using the normal telephone keypad.
6. The upper part of the display reverts to showing the functions currently assigned to each **Left** and **Right** key.
7. Select the display key against which to program the new function by pressing that **Left** or **Right** key.

CAUTION: Do not select the slot used for the **Admin** function. Replacing this function will lock the phone for further programming until reset through the telephone system by your System Administrator.
8. If the display slot is not already used, the display shows **BUTTON PROGRAMMED!**.
 - Press **EXIT** to end programming
 - or
 - Press **Cont** to continue programming other functions.
9. If the display slot already has a programmed function, the display shows **FEATURE ON BUTTON**.
 - Press **Repla** to replace that existing function with the one just programmed. The display then shows **BUTTON PROGRAMMED!** as in step 8 above.
 - Press **Keep** to keep the existing function and forget the function just programmed.
 - Press **Delete** to delete the existing function and forget the function just programmed.



Longhand Programming

1. Press **Admin** or **Admin 1**. See Function Key Programming on page 25.
2. Pressing **Expl?** to switch to longhand programming mode.
3. Press **Next** until the required feature required is shown, then press **Selct**.
4. If the feature requires some data to be entered, [] is shown at the bottom of the display. Enter the data using the normal telephone keypad.
5. The upper part of the display reverts to showing the features currently assigned to each and key.
6. Use the or keys to move between the pages of display keys.
7. Select the display key against which to program the new feature by pressing that or key

CAUTION: Do not select the slot used for the **Admin** function. Replacing this function will lock the phone for further programming until reset through the telephone system by your System Administrator.

8. If the display slot is not already used, the display shows **BUTTON PROGRAMMED!**
 - Press **EXIT** to end programming or
 - Press **Cont** to continue programming other functions.
9. If the display slot already has a programmed function, the display shows **FEATURE ON BUTTON.**
 - Press **Repla** to replace that existing function with the one just programmed. The display then shows **BUTTON PROGRAMMED!** as above.
 - Press **Keep** to keep the existing function and forget the function just programmed.
 - Press **Delete** to delete the existing function and forget the function just programmed.

Display Key Features

This section lists the features that can be programmed against  and  Function Keys. Both the shorthand and longhand names are shown. The shorthand name is the name that is displayed next to the programmed key, along with any data programmed for the feature.



Those functions marked with a **(!)** or an **(#)** can be programmed by the 5420 user. This programming requires the phone to already have a soft key assigned to the **Admin** (for **!** functions) and/or to **Admin1** (for **#** functions). See Function Key Programming on page 25 for lists of **Admin** and **Admin1** functions.

All of the following functions can be programmed onto your 5420 by your System Administrator. The command path is shown, for example:

```
[User | Digital Telephony | Emulation | Directory].
```

Dial (#)

Automatically dials the displayed number.

This function requires entry of the number to dial when programmed. The number is then displayed next to the  key. This function can be programmed through the phone by the user using an  **Admin 1** key.

Pressing the **Dial**  key dials the associated number.



```
[User | Digital Telephony | Dial]
```





See also:

- AD - Abbreviated Dial (!) on page 29.
- Prog - Abbreviated Dial Program (!) on page 46.

Group (#)

Answer or clear calls ringing a specific group.



This function requires entry of the group number (allocated by your System Administrator). When programmed, the group name is then displayed next to the  key. This function can be programmed through the phone by the user using an  **Admin 1** key and the group number.

A **◆** appears against the group when calls to that group are ringing. Pressing  displays details of one of those calls and options to drop (**Drop** ) the call, answer the call (**Answer** ) or exit the group monitor ( **EXIT**).

```
[User | Digital Telephony | Group]
```

User (#)

See the status of a specific user, call that user and pick-up calls to that user.

When programmed by your System Administrator (on the IP Office), the user name is entered. That name is then displayed next to the  key. This function can also be programmed through the phone by the user using an  **Admin 1** key and then the user number. Pressing the  key calls the user.

When the user is called the user name is underlined with a **◆** symbol beside it. Press the  key next to the name. **DkPickup** appears against a call appearance key. To pick up the call press this key.

If the System Administrator has setup group monitoring of the same user, pressing the  user key when the user is busy on a call displays several options. These are **Drop** (end the user's call), **Listn** (listen to the call), and **Aquir** (takeover the call). If the System Administrator has not setup group monitoring, then the options shown are **Call**, **Message**, **Vmail** and **CallB**.

```
[User | Digital Telephony | User]
```

Absnt - Set Absent Text

Set the users current absence message setting.



This function is currently not supported on the 5420 telephone.

Acct - Account Code Entry (!)

Make a call using an account code or enter an account code during a call.

This function can be programmed with or without data. This function can be programmed through the phone by the user using an  **Admin** key.

If programmed with data, the account code entered when programmed must match a valid account code set on the telephone system. The  **Acct** key displays that number.

If programmed without data, **ENTER ACCOUNT** is displayed after  **Acct** is pressed. Enter an account code and press **Set** .

If the account code entered does not match a valid account code set on the telephone system, **REENTER ACCOUNT** is displayed.

An  **Acct** key can be pressed before or during a call.

[User | Digital Telephony | Emulation | Account Code Entry]

AD - Abbreviated Dial (!)

Dial the displayed number.

This function requires entry of a number to dial when programmed. The  **AD** key displays that number. This function can be programmed through the phone by the user.

The number does not have to be a complete number, the user can dial additional digits after pressing  **AD**. * and # can be entered in the number to match IP Office shortcodes.

[User | Digital Telephony | Emulation | Abbreviated Dial]



See also:

- Dial (#) on page 28.
 - Prog - Abbreviated Dial Program (!) on page 46.
-

Admin - Self-Administer (!)

Access menus for programming functions against display keys.

This function can be programmed with or without data. If programmed with a setting of **1**, the key accesses a different set of functions. See Function Key Programming on page 25. This function can be programmed through the phone by the user using an existing  **Admin** key.

The  **Admin** key gives access to the menus for programming functions against  and  keys.

[User | Digital Telephony | Emulation | Self-Administer]

Apear - Appearance

Add a display line for call appearances with symbols being displayed for Incoming Calls, Connected and On Hold. See Call Appearance Keys on page 7.

This function does not require any data entered when programmed. However it is normal to enter some text such as **a=**, **b=** and so on for each call appearance key.



This function cannot be programmed through the phone by the user.

[User | Digital Telephony | Emulation | Appearance]

AutCB - Automatic Callback (!)

Sets a callback when free on busy extensions and callback when next used on unanswered extensions.

This function does not require any data entered when programmed. This function can be programmed through the phone by the user using an  **Admin** key.

When the called target extension does not answer or is busy, pressing  **AutCB** sets a callback on that extension. Whilst the callback is set, **AutCB** is shown with a  symbol. Pressing  **AutCB** again cancels the callback.

Hence, when the callback target extension becomes free or is next used, pressing  starts a call to that extension.

[User | Digital Telephony | Emulation | Automatic Callback]

See also:

- RBak - Cancel Ringback When Free on page 47.
- RBak+ - Ringback When Free on page 46.

Busy - Busy

Sets the extension as being busy. This feature is not applicable when working with multiple Call Appearance lines as all the call appearance lines must be in use before this function becomes active.

This function does not require any data entered when programmed. This function cannot be programmed through the phone by the user.

The  **Busy** key sets the extension as busy to callers. If a forward on busy number is set, it is followed (see FwBNo - Forward On Busy Number on page 36). Otherwise calls go to voicemail if on or receive busy tone if internal and ringing if external.

To return the extension from busy, press  **Busy** and then  **Speaker**.

[User | Digital Telephony | Advanced | Busy | Busy]

BusyH - Busy On Held

Switch the users busy on held status on/off.

This function requires data entered when programmed. Enter 0 for **off** or 1 for **on**.

This function cannot be programmed through the phone by the user.

Pressing  **BusyH** switches the user's 'busy on held' state to either on or off as indicated by the data value. When on, if the user has a call on hold, new callers receive busy tone (ringing if analogue) or are diverted to voicemail (if enabled), rather than ringing the user. This function also overrides call waiting indication when the user has a call on hold.

[User | Digital Telephony | Advanced | Busy | Busy On Held]



CFrwd - Call Forwarding All (!)



Switch call forwarding on/off and set the forwarding number.

This function can be programmed with or without a target forwarding number. This function can be programmed through the phone by the user using an  **Admin** key.

If programmed with a forwarding number, that number is shown next to **CFrwd**.

Pressing **CFrwd** switches on forwarding to that number.

If programmed without a forwarding number, when  **CFrwd** is pressed, the user's current forwarding number setting is shown. Change the number using the telephone keypad and <<<  to backspace. When the number set as required press **Done** .

When call forwarding is on, **CFrwd** is shown with a  symbol and **D** (Diverted) is shown at the top of the display. To switch call forwarding off, press  **CFrwd** again.

[User | Digital Telephony | Emulation | Call Forwarding All]

See also:

- FwNOn - Forward On No Answer On on page 38
- FwUOn - Forward Unconditional On on page 38.
- FwdNo - Forward Number on page 37.
- FwdH+ - Forward Hunt Group Calls On on page 37

ClrCW - Clear CW

Clears the current connected call and connects any waiting call. This feature is not applicable when working with multiple Call Appearance lines.

This function does not require any data entered when programmed. This function cannot be programmed through the phone by the user.

Pressing  **ClrCW** disconnects the extension's current call and connects any waiting call.

[User | Digital Telephony | Advanced | Call | Clear CW]

CnfRV - Conference Meet Me

Allows the extension to join a specified conference.

This function requires the conference number to be entered when programmed. That number is then shown next to **CnfRV**. This function cannot be programmed through the phone by the user.

Pressing  **CnfRV** places the extension into the specified conference. Note that the number of conference parties allowed at any time is determined by the telephone system.

[User | Digital Telephony | Advanced | Call | Conference Meet Me]

Conf+ - Conference Add

Places all calls held by the extension into a conference.

This function does not require any data entered when programmed. This function cannot be programmed through the phone by the user.

Pressing  **Conf+** places the extension and any calls it has put on hold into a conference. This function will not work if the extension has a current call.

[User | Digital Telephony | Advanced | Call | Conference Add]

CPark - Call Park (!)

Park the current call.

This function can be programmed with or without data. This function can be programmed through the phone by the user using an  **Admin** key.

If programmed with data, the number entered is shown next to the  **CPark** key and is the number assigned to the parked call.

If programmed without data, the key displays just **CPark**. Calls parked using this key are assigned a number based on the parking extensions number. For example, extension 290's first parked call is numbered 2900, its next 2901 if 2900 is still parked and so on. If calls are parked using this key, **CPark** is shown with a ◀ symbol. Pressing the key again displays the user's parked calls and allow them to be retrieved. Parked calls are retrieved with the **Ride** function (page 48).

If not retrieved elsewhere, a parked call will recall to the parking extension after a set time.

[User | Digital Telephony | Emulation | Call Park]

See also:

- Park - Park (#) on page 44.
- Park - Call Park to Other Extension (!) on page 44.
- Ride - Ride Call on page 48.

CPkUp - Call Pickup (!)

Answer a call ringing elsewhere on the telephone system.

This function does not require any data entered when programmed. This function can be programmed through the phone by the user using an  **Admin** key.

The  **CPkUp** call answers (pickup) any call currently ringing on the telephone system.

Note: We recommend that this function is only used on systems with a small number of users all in one area. Use of this function on larger system may lead to confusion.

[User | Digital Telephony | Emulation | Call Pickup]

See also:

- PickA - Call Pickup Any on page 45.
- PickG - Call Pickup Group on page 45.
- PickM - Call Pickup Members on page 45.

CWOff - Call Waiting Off

Switches call waiting for the extension off.

This function does not require any data entered when programmed. This function cannot be programmed through the phone by the user.

The  **CWOff** key switches call waiting for the extension off.

[User | Digital Telephony | Advanced | Call | Call Waiting Off]

CWOn - Call Waiting On

Switches call waiting for the extension on/off.

This function does not require any data entered when programmed. This function cannot be programmed through the phone by the user.

The  **CWOn** key toggles call waiting on/off. When call waiting is on, **CWOn** is shown with a ◀ symbol. When call waiting is on and the extension is on a call, any additional call receives ringing rather than busy tone.

[User | Digital Telephony | Advanced | Call | Call Waiting On]

CWSus - Call Waiting Suspend

Suspend the current call at the exchange and answer the waiting call.

This function is not supported in the USA.

If no slot number is specified when the function is programmed, exchange slot 0 is used. This function cannot be programmed through the phone by the user.

Pressing  **CWSus** is only supported if the exchange provides a Q.931 suspend call facility.

[User | Digital Telephony | Advanced | Call | Call Waiting Suspend]

See also:

- Resum - Resume Call on page 48.

DCW - Dial CW

Allows the user to force another extension to have call waiting mode on for the duration of a call attempt. This function is not supported in the USA.

This function requires the target extension number to be entered when programmed. That number is then shown next to **DCW**. This function cannot be programmed through the phone by the user.

Normally, if the target extension is on a call and doesn't have call waiting on, any new call will receive busy tone or be diverted to voicemail. Pressing  **DCW** will cause the target extension to receive call waiting indication and allow the caller to hear ringing until answered.

[User | Digital Telephony | Advanced | Dial | Dial CW]

See also:



- Queue - Call Queue on page 46.

Dir - Directory (!)

Accesses the telephone system directory.

This function does not require any data entered when programmed. This function can be programmed through the phone by the user using an  **Admin** key.

Pressing  **Dir** displays a number of options.

- **INDeX**  - Search for a matching extension user name on the telephone system.
- **Group**  - Search for a matching group name on the telephone system.
- **Extrn**  - Search for a name match in the telephone systems directory of external numbers.

[User | Digital Telephony | Emulation | Directory]

Direct - Dial Direct

Connects a call to the target extension without any ringing.

This function requires the target extension number to be entered when programmed. That number is then shown next to **Direct**. The target extension must be capable of auto-answering. This function cannot be programmed through the phone by the user.

[User | Digital Telephony | Advanced | Dial | Dial Direct]

DNDOn - Do Not Disturb On

Puts the extension into 'do not disturb' (no calls) mode.

This function does not required any data to be entered when programmed. This function cannot be programmed through the phone by the user.

Pressing  **DNDOn** toggles the extension's do not disturb state. When on, **DNDOn** is shown with a **N** symbol and the display includes an **N** (No calls).

[User | Digital Telephony | Advanced | Do Not Disturb | Do Not Disturb On]

See also:

- SAC - Send All Calls (!) on page 49.

DNDOf - Do Not Disturb Off

Takes the extension out of 'do not disturb' (no calls) mode.

This function does not required any data to be entered when programmed. This function cannot be programmed through the phone by the user.

Pressing  **DNDOf** switches the extension's do not disturb state off.

[User | Digital Telephony | Advanced | Do Not Disturb | Do Not Disturb Off]

DNDX+ - Do Not Disturb Exception Add

Adds the specified number to the extension's do not disturb exception list.

This function requires entry of the calling number when programmed. That number is then shown next to **DNDX+**. This function cannot be programmed through the phone by the user.

Pressing  **DNDX+** adds the set number to the extension's do not disturb exception list. That number can then call the extension and transfer calls to the extension even when the extension is in do not disturb mode.

[User | Digital Telephony | Advanced | Do Not Disturb | Do Not Disturb Exception Add]

DNDX- - Do Not Disturb Exception Delete

Removes the specified number from the extension's do not disturb exception list.

This function requires entry of the calling number when programmed. That number is then shown next to **DNDX-**. This function cannot be programmed through the phone by the user.

Pressing  **DNDX-** adds the set number to the extension's do not disturb exception list. That number can then call the extension and transfer calls to the extension even when the extension is in do not disturb mode.

[User | Digital Telephony | Advanced | Do Not Disturb | Do Not Disturb Exception Del]

DPkUp - Directed Call Pickup (!)

Answer a call currently ringing at a specified user or group.

This function can be programmed with or without a target extension or group number. This function can be programmed through the phone by the user using an  **Admin** key.

If programmed with a target number, the  **DPkUp** key displays that number. When a call is ringing at that extension or group, press  **DPkUp** to answer (pick up) that call.

If programmed without a target number, pressing  **DPkUp** allows the user to enter the target number for that pickup attempt.

[User | Digital Telephony | Emulation | Directed Call Pickup]

Drop - Drop (!)

Clears a current calls.

This function does not require any data entered when programmed. This function can be programmed through the phone by the user using an  **Admin** key.

For a call in progress, pressing  **Drop** disconnects the caller.

When drop is used, silence is returned to the user rather than dial tone. This is intended operation, reflecting that **Drop** is mainly used by call center headset users.

[User | Digital Telephony | Emulation | Drop]

DTone - Secondary Dial Tone

Return secondary dial tone to the user.

This function is currently not supported on the 5420 telephone.

Emrgy - Dial Emergency

Dials a specified number regardless of any call barring applied to the user.

This function requires entry of a number to dial when programmed. That number is then shown next to **Emrgy**. This function cannot be programmed through the phone by the user.

[User | Digital Telephony | Advanced | Dial | Dial Emergency]

Flash - Flash Hook (#)

Send a hook flash signal to the currently connected line.



This function does not require any data entered when programmed. This function cannot be programmed through the phone by the user. This function can be programmed through the phone by the user using an  **Admin 1** key.

[User | Digital Telephony | Advanced | Miscellaneous | Flash Hook]

FoITo - Follow Me To

Forwards calls from this extension to the specified target.

This function requires the target extension to be entered when programmed. The extension number is then shown next to **FoITo**. This function cannot be programmed through the phone by the user.

Pressing  **FoITo** sets the extension's Follow Me To number to the specified extension and switches follow me use on. Whilst on, **FoITo** is shown with a  symbol. Press  **FoITo** again to switch off.

[User | Digital Telephony | Advanced | Follow Me | Follow Me To]

FwBNo - Forward On Busy Number

Sets the extensions forwarding number for use with forward on busy and forward on no answer.

This feature requires the target number to be entered when programmed. The number set is shown next to **FwBNo**. This function cannot be programmed through the phone by the user.

Pressing  **FwBNo** set the extension's forwarding number to that specified by the key pressed.

[User | Digital Telephony | Advanced | Forward | Forward On Busy Number]

See also:



- FwBOn - Forward On Busy On on page 36
- FwNOn - Forward On No Answer On on page 38.

FwBOn - Forward On Busy On

Switches the extension to forward on busy on.

Note: When Call Appearance keys have been allocated, all the call appearance lines must be in use before this function becomes active.

This function does not required any data to be entered when programmed. This function cannot be programmed through the phone by the user.

Pressing  **FwBOn** toggles the extension's forward on busy state and can also be used in conjunction with FwBOf - Forward On Busy Off on page 36. When on, **FwBOn** is shown with a  symbol. When on, calls are forwarded to the extension's forward on busy number.

[User | Digital Telephony | Advanced | Forward | Forward On Busy On]

See also:

- FwBNo - Forward On Busy Number on page 36.

FwBOf - Forward On Busy Off

Switches the extension to forward on busy off. Used in conjunction with FwBOn - Forward On Busy On on page 36

This function does not required any data to be entered when programmed. This function cannot be programmed through the phone by the user.

Pressing  **FwBOf** switches the extension's use of forward on busy off.

[User | Digital Telephony | Advanced | Forward | Forward On Busy Off]

FwdH+ - Forward Hunt Group Calls On

Switches the extension to forward hunt group calls it receives.

Note: Calls are only forwarded when forward unconditional (see CFwd - Call Forwarding All (!) on page 31 or FwUOn - Forward Unconditional On on page 38 is also on.

This function does not required any data to be entered when programmed. This function cannot be programmed through the phone by the user.

Pressing  **FwdH+** toggles the feature on/off. When on, **FwdH+** is shown with a ◀ symbol. Can also be used in conjunction with FwdH- - Forward Hunt Group Calls Off on page 37.

[User | Digital Telephony | Advanced | Forward | Forward Hunt Group Calls On]

FwdH- - Forward Hunt Group Calls Off

Switches the extension to forward unconditional off.

This function does not required any data to be entered when programmed. This function cannot be programmed through the phone by the user.

Pressing  **FwdH-** switches the extension's use of forward hunt group calls off. Can also be used in conjunction with FwdH+ - Forward Hunt Group Calls On on page 37

[User | Digital Telephony | Advanced | Forward | Forward Hunt Group Calls Off]

FwdNo - Forward Number

Sets the extension's forwarding number for use when forwarding all calls.

This feature requires the target number to be entered when programmed. The number set is shown next to **FwdNo**. This function cannot be programmed through the phone by the user.

Pressing  **FwdNo** sets the extension's forwarding number to that specified by the key pressed.

[User | Digital Telephony | Advanced | Forward | Forward Number]

Also See:

- FwBOn - Forward On Busy On on page 36
- FwUOn - Forward Unconditional On on page 38

FwdOf - Cancel All Forwarding

Switch off all call forwarding.

This function does not require any data entered when programmed. This function cannot be programmed through the phone by the user.



Pressing  **FwdOf** switches off all the extensions call forwarding options. It does not delete the forwarding number settings.

[User | Digital Telephony | Advanced | Call | Cancel All Forwarding]

FwNOn - Forward On No Answer On

Switches the extension to forward on no answer on.

This function does not required any data to be entered when programmed and cannot be programmed through the phone by the user.

Pressing  **FwNOn** toggles the extension's forward on no answer state. When on, **FwNOn** is shown with a  symbol. When on, calls are forwarded to the extension's forward on busy number (see FwBNo - Forward On Busy Number on page 36).

[User | Digital Telephony | Advanced | Forward | Forward On No Answer On]

FwNOF - Forward On No Answer Off

Switches the extension to forward on no answer off.

This function does not required any data to be entered when programmed. This function cannot be programmed through the phone by the user.

Pressing  **FwNOF** switches the extension's use of forward on no answer off. Can also be used in conjunction with FwNOn - Forward On No Answer On on page 38.



[User | Digital Telephony | Advanced | Forward | Forward On No Answer Off]

FwUOn - Forward Unconditional On

Switches the extension to forward all its calls except hunt group calls.

Note: When Call Appearance keys have been allocated, all the call appearance lines must be in use before this function becomes active.

This function does not required any data to be entered when programmed. This function cannot be programmed through the phone by the user.

Pressing  **FwUOn** toggles the extension's forward on busy state. When on, **FwUOn** is shown with a  symbol and the display includes a **D**. When on, calls are forwarded to the extension's forward number (see FwBNo - Forward On Busy Number on page 36).

[User | Digital Telephony | Advanced | Forward | Forward Unconditional On]

FwUOf - Forward Unconditional Off

Switches the extension's forward unconditional off.



This function does not required any data to be entered when programmed. This function cannot be programmed through the phone by the user.

Pressing  **FwUOf** switches the extension's use of forward unconditional off. Can also be used in conjunction with FwUOn - Forward Unconditional On on page 38.

[User | Digital Telephony | Advanced | Forward | Forward Unconditional Off]

GrpPg - Group Paging (!)

This function can be programmed with or without a target extension or group number. This function can be programmed through the phone by the user using an  **Admin** key.

If programmed with a target number, the  **GrpPg** key displays that number. When  **GrpPg** is pressed, it will make a paging call to that number.

If programmed without a target number, the number must be dialed after the user presses  **GrpPg**.

[User | Digital Telephony | Emulation | Group Paging]

HdSet - Headset Toggle (!)

This function does not require any data entered when programmed. This function can be programmed through the phone by the user using an  **Admin** key.

The programmed key will then switch the phone between handset and headset operation. When on, **HdSet** is shown on a dark background.

There is no linkage between a programmed **HdSet** key and the phone's  **HEADSET** key.

[User | Digital Telephony | Advanced | Miscellaneous | Headset Toggle]

Here- - Follow Me Here Cancel

If another extension has follow me set to this extension, switches off the follow me action.

This function requires the original target extension to be entered when programmed. The extension number is then shown next to **Here-**. This function cannot be programmed through the phone by the user.

Pressing  **Here-** cancels the use of follow me at the target extension.

[User | Digital Telephony | Advanced | Follow Me | Follow Me Here Cancel]

Here+ - Follow Me Here

Forwards calls to the target extension to this extension.

This function requires the original target extension to be entered when programmed. The extension number is then shown next to **Here+**. This function cannot be programmed through the phone by the user.



Pressing  **Here+** sets the target extension's Follow Me To number to that this extension. Calls to the target extension are then forwarded to this extension.

[User | Digital Telephony | Advanced | Follow Me | Follow Me Here]

HfAns - Internal Auto-Answer (!)

Answers internal calls after a single ring.

This function does not require any data entered when programmed. This function can be programmed through the phone by the user using an  **Admin** key.

The  **HfAns** key toggles internal auto-answer on/off. When on, **HfAns** is shown with a  symbol.

[User | Digital Telephony | Emulation | Internal Auto Answer]



See also:



- RngOf - Ringer Off (!) on page 49.
- CWOn - Call Waiting On on page 33.

HGE_{na} - Hunt Group Enable

Sets the extension's membership of a group or groups as enabled. This function **does not** take the Hunt Group In/Out of Service.

This function can be programmed with or without a target group number. This function cannot be programmed through the phone by the user.

If programmed without a group number, pressing  **HGE_{na}** toggles all the extension's group memberships to either enabled or disabled. A  is shown next to  **HGE_{na}** when the group memberships are enabled.

If programmed with a group number, that number is shown next to  **HGE_{na}**. Pressing  **HGE_{na}** will enable the extension's membership of that group. In this mode the key does not toggle.

When enabled, **G** is shown on the display and the extension will receive group calls.

[User | Digital Telephony | Advanced | Hunt Group | Hunt Group Enable]

See also:

- HGNS+ - Set Hunt Group Night Service (!) on page 40.
- HGOS+ - Set Hunt Group Out of Service on page 41.
- HGDis - Hunt Group Disable on page 40.

HGD_{is} - Hunt Group Disable

Sets the extension's group membership as disabled. Used with HGE_{na} - Hunt Group Enable on page 40. This function **does not** take the Hunt Group Out of Service.

This function can be programmed with or without a target group number. This function cannot be programmed through the phone by the user.

If programmed without a group number, pressing  **HGD_{is}** disables all the extension's group memberships.

If programmed with a group number, pressing  **HGD_{is}** disables just the extension's membership of that group.

[User | Digital Telephony | Advanced | Hunt Group | Hunt Group Disable]

HGNS+ - Set Hunt Group Night Service (!)

Put a specific hunt group into or out of night service mode.

This function requires the hunt group number to be entered when programmed. The hunt group number is then shown next to **HGNS+**. This function can be programmed through the phone by the user using an  **Admin** key.

Pressing  **HGNS+** puts the hunt group into night service. Group calls then go to its night service fallback group if set or, if not answered, to voicemail.

[User | Digital Telephony | Advanced | Set | Set Hunt Group In Service]

HGNS- - Clear Hunt Group Night Service

Returns a hunt group that has been manually put into night service back to normal service. Used with HGNS+ - Set Hunt Group Night Service (!) on page 40.

This function requires that the hunt group number is entered when programmed. This function cannot be programmed through the phone by the user.

The hunt group number is shown next **HGNS-**. Pressing  **HGNS-** puts the group back into normal service if in night service.

[User | Digital Telephony | Advanced | Call | Clear Hunt Group Night Service]

HGOS+ - Set Hunt Group Out of Service

Put a specific hunt group out of service mode.

This function requires the hunt group number to be entered when programmed. The hunt group number is then shown next to **HGOS+**. This function cannot be programmed through the phone by the user.

Pressing **HGOS+** puts the hunt group out of service. Group calls then go to its out of service fallback group if set or, if not answered, to voicemail.

[User | Digital Telephony | Advanced | Set | Set Hunt Group Out Service]

HGOS- - Clear Hunt Group Out of Service

Returns a hunt group that has been manually put into out of service back to normal service. Used with HGOS+ - Set Hunt Group Out of Service on page 41.

This function requires that the hunt group number is entered when programmed. This function cannot be programmed through the phone by the user.

The hunt group number is shown next **HGOS-**. Pressing **HGOS-** puts the group back into normal service if in night service.

[User | Digital Telephony | Advanced | Call | Clear Hunt Group Out Of Service]

Hold - Hold Call

Place the current external call on hold at the central office. This function is not supported in the USA.

If no exchange slot number is specified when the function is programmed, exchange slot 0 is used. This function cannot be programmed through the phone by the user.

Pressing **Hold** is only supported if the exchange provides a Q.931 hold facility. It is not the same as local hold provided by the telephone system.

[User | Digital Telephony | Advanced | Hold | Hold Call]

See also:

- Rtriv - Retrieve Call on page 48.

HoldCW - Hold Call Waiting

Place the current call on hold and connects any call waiting. This function is not supported in the USA.

This function does not required any data to be entered when programmed. This function cannot be programmed through the phone by the user.

Pressing **HoldCW** places the current call on hold and connects any call waiting without any ringing.

[User | Digital Telephony | Advanced | Hold | Hold CW]

IAuto - Automatic Intercom

Connects call to the extension without ringing.

This function requires entry of an extension number when programmed. The target extension must be support handsfree operation. This function cannot be programmed through the phone by the user.

Press **IAuto** connects the call without any ringing at the remote extension. If the target extension is busy or not available, the call will follow any forwarding or diversion to voicemail set.

[User | Digital Telephony | Emulation | Automatic Intercom]

ICSeq - Set Inside Call Sequence

Sets the ringing pattern (sequence) used for internal calls.

This function is currently not supported on the 5420 telephone.

IDial - Dial Intercom

The same as IAuto - Automatic Intercom on page 41. This function cannot be programmed through the phone by the user.

[User | Digital Telephony | Emulation | Dial Intercom]

Inclu - Dial Inclusion

Intrudes on a call in progress at the target extension.

This function is currently not supported on the 5420 telephone.

Intru - Call Intrude

Intrudes on a call in progress at the target extension, creating a conference between the callers and the intruding extension.

This function requires entry of the target extension number when programmed. The  **Intru** key shows the target extension number. This function cannot be programmed through the phone by the user.

Pressing  **Intru** intrudes on the call in progress.

Note: That the System Administrator must configure the intruding extension as being able to intrude. Additionally none of the other extensions involved in the call can have "Cannot be intruded on" status.

[User | Digital Telephony | Advanced | Call | Call Intrude]

Listn - Call Listen

Allow the extension to listen to groups calls to the target extension. The call parties cannot hear the listening extension.

This function requires entry of the target extension number when programmed. This function cannot be programmed through the phone by the user.

The  **Listn** key shows the target extension number.

Use of this function requires setup of the extension's monitor group by the System Administrator. This function requires the telephone system to have some free conference capacity when invoked.

[User | Digital Telephony | Advanced | Call | Call Listen]

See also:

- Intru - Call Intrude on page 42.
- Recor - Call Record on page 50.
- Steal - Call Steal on page 50.

Login - Extn Login

Logs the current user onto the extension.

This function does not require any data to be entered when programmed. The user cannot program this function through the phone. Pressing the soft key login prompts the user **Enter Extn:**. The user enters the desired extension and presses the soft function key **Next**. The user is prompted for the password. The user enters the password and presses the soft function key "Done."

[User | Digital Telephony | Advanced | Extn | Extn Login]

Logof - Extn Logout

Logs the current user off the extension.

This function does not required any data to be entered when programmed. This function cannot be programmed through the phone by the user.

Pressing  **Logof** logs the current user off the extension. A new user must then log on to use the extension or dial ***36** to re-associate the extension with its default user.

[User | Digital Telephony | Advanced | Extn | Extn Logout]

Music - Hold Music

Plays the telephone system's music on hold.

This function does not required any data to be entered when programmed. This function cannot be programmed through the phone by the user.

Pressing  **Music** plays the telephone system's music on hold through the extension.

[User | Digital Telephony | Advanced | Hold | Hold Music]

NATim - Set No Answer Time

Sets the extension's no answer time after which ringing calls are forwarded or go to voicemail.

This function requires the time in seconds to be entered when programmed. The value is shown next to **NATim**. This function cannot be programmed through the phone by the user.

Pressing  **NATim** sets the extension's busy wrap up time to the indicated number of seconds. This time is used to set a delay between ending one call and the next call ringing the extension (the waiting call may be indicated on the display however).

[User | Digital Telephony | Advanced | Set | Set No Answer Time]

See also:

- WUTim - Set Wrap Up Time on page 52.
-

OCSeq - Set Outside Call Sequence

Sets the ringing pattern (sequence) used for internal calls.

This function is currently not supported on the 5420 telephone.

Page - Page

Page the specified target extension or group. The target must be capable of hands-free speech.

This function requires the target extension or group number to be specified when programmed. The target is then shown next to  **Page**. This function cannot be programmed through the phone by the user.



[User | Digital Telephony | Advanced | Dial | Dial Paging]



See also:

- GrpPg - Group Paging (!)on page 38.
-

Park - Park (#)

Park calls to and retrieve calls from a specific park slot.

This function requires entry of a park slot number when programmed. That number and **Park** then appears next to the  key. This function can be programmed through the phone by the user using an  **Admin 1** key. The user can use the  key to park calls into that park slot and unpark calls from that slot. Parked calls can also be retrieved with the **Ride** function (see page 48).

When a call is parked in that park slot by the user, a  symbol appears next to the  key and parked by another user, then **Park** is underlined.

[User | Digital Telephony | Park]

See also:

- CPark - Call Park (!) on page 32.
- Park - Call Park to Other Extension (!) on page 44.
- Ride - Ride Call on page 48.

Park - Call Park to Other Extension (!)

Allows a call to be parked against another extension. Depending on the other extension's type, its parked call indication is triggered. Parked calls are retrieved with the **Ride** function (see page 48).

This function can be programmed with or without a target extension number. This function can be programmed through the phone by the user using an  **Admin** key.

If programmed with a number, the  **Park** key displays that number. After answering a call, pressing  **Park** parks the call against that extension.

If programmed without a number, after pressing  **Park** the target for the parked call must be entered.

The parked call is assigned a number based on the parking extensions number. For example, extension 290's first parked call is numbered 2900, it's next 2901 if 2900 is still parked and so on. If not retrieved elsewhere, a parked call will recall to the parking extension after a set time.

[User | Digital Telephony | Emulation | Call Park to Other Extension]

See also:

- CPark - Call Park (!) on page 32.
- Park - Call Park to Other Extension (!) on page 44.
- Ride - Ride Call on page 48.

PCall - Priority Call

Call a specified target extension even if that extension is set to 'Do not Disturb'.

This function requires the target extension number to be specified when programmed. The target extension is then shown next to  **PCall**. This function cannot be programmed through the phone by the user.

[User | Digital Telephony | Advanced | Call | Priority Call]

PhyEx - Dial Physical Extension by Number

Dial a specified extension regardless of the current logged on user at that extension and any forwarding, follow me and do not disturb settings applied by the extension user.

This function requires the target extension number to be specified when programmed. The target extension is then shown next to  **PhyEx**. This function cannot be programmed through the phone by the user.

This function is currently only available on US based systems.

[User | Digital Telephony | Dial | Dial Physical Extension by Number]

PickA - Call Pickup Any

Pickup any ringing call.

This function does not require any data entered when programmed. This function cannot be programmed through the phone by the user.

Pressing  **PickA** answers any call currently ringing on the telephone system.

Note: We recommend that this function is only used on systems with a small number of users all in one area. Use of this function on larger system may lead to confusion.

[User | Digital Telephony | Advanced | Call | Call Pick Up Any]

See also:

- CPkUp - Call Pickup (!) on page 32.
- DPKUp - Directed Call Pickup (!) on page 35.

PickG - Call Pickup Group

Pickup any ringing call to a group of which the extension is a member.

This function does not require any data entered when programmed. This function cannot be programmed through the phone by the user.

Pressing  **PickG** answers any call currently ringing a group of which the extension is a member.

[User | Digital Telephony | Advanced | Call | Call Pick Up Group]

See also:

- CPkUp - Call Pickup (!) on page 32.
- DPKUp - Directed Call Pickup (!) on page 35.

PickM - Call Pickup Members

Pickup any call ringing an extension that is a member of the specified group.

This function requires entry of the target group number when programmed or the group name in quotation marks. This function cannot be programmed through the phone by the user.

Pressing  **PickM** answers any call currently ringing a member of the specified group. The call does not have to be a call to the group number.

[User | Digital Telephony | Advanced | Call | Call Pickup Members]

See also:

- CPkUp - Call Pickup (!) on page 32.
- DPKUp - Directed Call Pickup (!) on page 35.

Prog - Abbreviated Dial Program (!)

Select and program numbers against display keys.

This function can be programmed through the phone by the user using an  **Admin** key.

[User | Digital Telephony | Emulation | Abbreviated Dial Program]

See also:

- Dial (#) on page 28.
- AD - Abbreviated Dial (!) on page 29.

Quota - Clear Quota

Clears (resets) the time quota for connections to a specified external data service (eg. the internet).

This function requires entry of the service name when programmed. If left blank then the quotas for all services are cleared (reset). This function cannot be programmed through the phone by the user.

[User | Digital Telephony | Advanced | Call | Clear Quota]

Queue - Call Queue

Places a current call into the call queue of a specified extension. Allows calls to be transferred to extensions that return busy tone. This feature is not applicable when working with multiple Call Appearance lines.

This function requires entry of a target extension number when programmed. This function cannot be programmed through the phone by the user.

During a call, pressing  **Queue** places that call in the target extensions call queue. If the target extension is free, it rings immediately. If the target extension is busy, it rings when it becomes free again.

[User | Digital Telephony | Advanced | Call | Call Queue]



See also:

- DCW - Dial CW on page 33.

RBak+ - Ringback When Free

Sets a callback when free on busy extensions and callback when next used on unanswered extensions.

This function does not require any data entered when programmed. This function cannot be programmed through the phone by the user.

When an extension called does not answer or is busy, pressing  **AutCB** sets a callback on that extension. Whilst the callback is set, **AutCB** is shown with a  symbol. Pressing  **AutCB** again cancels the callback.

When the extension becomes free or is next used, **Ring Back to** and the number appears on the phone that set the callback. Pressing  answers the ringback and starts a call to the callback target.

[User | Digital Telephony | Advanced | Miscellaneous | Ringback When Free]





See also:

- AutCB - Automatic Callback (!) on page 30.

RBak - Cancel Ringback When Free

Cancels any set ringback when free function.

This function does not require any data entered when programmed. This function cannot be programmed through the phone by the user.

Pressing  **RBak**- switches off any set ring back when free. If the ringback was set using a  **AutCB** key, that key will still appear with a  symbol that can be cancelled by pressing the  **AutCB** key again.

[User | Digital Telephony | Advanced | Miscellaneous | Cancel Ringback When Free]

RBSeq - Set Ringback Sequence

Sets the ringing pattern (sequence) used for voicemail and ringback calls.

This function is currently not supported on the 5420 telephone.

Recor - Call Record

Records the current call at the specified target extension.

This function requires entry of a target extension number when programmed. This function cannot be programmed through the phone by the user.

When  **Recor** is pressed, the target extensions current call is recorded into their voicemail mailbox.

Note: This function requires Voicemail Pro to be installed. If advice of call recording is enabled, the call parties will hear a warning before the recording takes place. In some locations it may be a legal requirement to advise callers that a call is being recorded.

[User | Digital Telephony | Advanced | Call | Call Record]

See also:

- Listn - Call Listen on page 42.
- Steal - Call Steal on page 50.

Relay - Relay Pulse

Pulse the specified external output relay (1 or 2) on for 5 seconds.

This function requires the relay switch (1 or 2) on the telephone system to be entered when programmed. This function cannot be programmed through the phone by the user.

Pressing  **Relay** switches the specified relay on for 5 seconds and then off.

[User | Digital Telephony | Advanced | Relay | Relay Pulse]

Rely+ - Relay On

Switch the specified external output relay (1 or 2) on.

This function requires the relay switch (1 or 2) on the telephone system to be entered when programmed. This function cannot be programmed through the phone by the user.

Pressing  **Relay** switches the specified relay on.

[User | Digital Telephony | Advanced | Relay | Relay On]

Rely - Relay Off

Switch the specified external output relay (1 or 2) off.

This function requires the relay switch (1 or 2) on the telephone system to be entered when programmed. This function cannot be programmed through the phone by the user.

Pressing  **Relay** switches the specified relay off.

[User | Digital Telephony | Advanced | Relay | Relay Off]

Resum - Resume Call

Resume a call previously suspended into a specified ISDN exchange slot. This function is not supported in the USA.

This function requires the exchange slot number to be specified when programmed.

The slot number is then shown next to  **Resum**. This function cannot be programmed through the phone by the user.

Pressing  **Resum** resumes any call previous suspended into the specified exchange slot. Suspended calls can be resumed by any extension.

[User | Digital Telephony | Advanced | Call | Resume Call]

See also:

- SusCW - Suspend CW on page 50.
- Suspe - Suspend Call on page 50.

Rtriv - Retrieve Call

Retrieve a call previously held into a specified ISDN central office slot and is only supported if the central office provides a Q.931 hold facility. This function is not supported in the USA.

This function requires the central office slot number to be specified when programmed. The slot number is then shown next to  **Rtriv**. This function cannot be programmed through the phone by the user.

Pressing  **Rtriv** retrieves any call previous held into the specified central office slot. Held calls can only be retrieved by the extension that put the call on central office hold.

[User | Digital Telephony | Advanced | Call | Retrieve Call]

See also:

- Hold - Hold Call on page 41.

Ride - Ride Call

Unpark a parked call from a specified system park slot.

This function requires the park slot number to be specified when programmed. The slot number is then shown next to  **Ride**. This function cannot be programmed through the phone by the user.

Pressing  **Ride** unparks any call previously parked into the specified system park slot by the same or another extension.

[User | Digital Telephony | Advanced | Call | Ride Call]



See also:

- CPark - Call Park (!) on page 32
- Park - Park (#) on page 44.
- Park - Call Park to Other Extension (!) on page 44.

RngOf - Ringer Off (!)

Switches the phones audible ringer on/off.

This function does not require any data entered when programmed. This function can be programmed through the phone by the user using an  **Admin** key.

The programmed  **RngOf** key toggles the phones call ringer on/off. When off, **RngOf** is shown with a .

[User | Digital Telephony | Emulation | Ringer Off]



See also:

- CWOn - Call Waiting On on page 33
- HfAns - Internal Auto-Answer (!) on page 39.

SAC - Send All Calls (!)

Switch do not disturb on/off.

This function does not require any data entered when programmed. This function can be programmed through the phone by the user using an  **Admin** key.

The  **SAC** key switches "do not disturb" on/off. When on, **SAC** is shown with a  symbol and the display includes an **N** (No calls).

When **SAC** is on, callers receive busy tone or are diverted to voicemail. For each user the System Administrator can set which numbers can still call when SAC is on. If the extension user has Phone Manager, they can set those numbers themselves. With a call already connected and another call already alerting, activating SAC will not affect the already alerting call.

[User | Digital Telephony | Emulation | Send All Calls]



See also:

- DNDOn - Do Not Disturb On on page 34.

Spres - AD Suppress (!)

Replace the display of dialed digits with **s** characters.

This function does not require any data entered when programmed. This function can be programmed through the phone by the user using an  **Admin** key.

The programmed  **Spres** key toggles the display of dialed digits on/off. When on, **Spres** is shown with a  symbol and each dialed digit is replaced by **s** on the display.

[User | Digital Telephony | Emulation | AD Suppress]

Steal - Call Steal

Take over a call from a specified extension or retrieve a call just transferred or forwarded. This function cannot be programmed through the phone by the user.

If a target extension number is entered when this function is programmed, **Steal** displays that number. Pressing **Steal** when the target extension has a call will take over the call.

If no target extension number is entered when the function is programmed, **Steal** retrieves the last calls transferred from the extension. This includes calls diverted to voicemail.

- Notes:**
1. Target extension must not have *Cannot Intrude* set.
 2. Extension with **Steal** allocated must also have *Can Intrude* set.

[User | Digital Telephony | Advanced | Call | Call Steal]

SusCW - Suspend CW

Suspend the current external call at the exchange and answer the waiting call. This feature is not supported in the USA.

If no exchange slot number is specified when the function is programmed, exchange slot 0 is used. This function cannot be programmed through the phone by the user.

Pressing **SusCW** is only supported if the exchange provides a Q.931 suspend call facility.

[User | Digital Telephony | Advanced | Suspend | Suspend CW]

See also:

- Resum - Resume Call on page 48.

Suspe - Suspend Call

Suspend the current external call at the exchange. This feature is not supported in the USA.

If no exchange slot number is specified when the function is programmed, exchange slot 0 is used. This function cannot be programmed through the phone by the user.

Pressing **Suspe** is only supported if the exchange provides a Q.931 suspend call facility.

[User | Digital Telephony | Advanced | Suspend | Suspend Call]

See also:

- Resum - Resume Call on page 48.

Timer - Timer (!)

Starts a timer on the phone's display.

This function does not require any data entered when programmed. This function can be programmed through the phone by the user using an  **Admin** key.

The timer is reset for each new call made or answered. When timer mode is selected, a  is shown next to **Timer**.

[User | Digital Telephony | Emulation | Timer]

TmDay - Time of Day (!)

Replaces the user name and number details on the phone display with the date and time.

This function does not require any data entered when programmed. This function can be programmed through the phone by the user using an  **Admin** key.

When time and date mode is selected, a  is shown next to **TMDay**.

[User | Digital Telephony | Emulation | Time of Day]

Toggl - Toggle Calls

Cycle through each of the extension user's current held calls.

This function does not require any data entered when programmed. This function cannot be programmed through the phone by the user.

Pressing  **Toggl** puts the user's current call on hold and connects a previously held call.

[User | Digital Telephony | Advanced | Call | Toggle Calls]

VMRB- - Voicemail Ringback Off

Switches voicemail ringback for the extension off.

This function does not require any data entered when programmed. This function cannot be programmed through the phone by the user.



The  **VMRB-** key switches voicemail ringback for the extension off.

[User | Digital Telephony | Advanced | Voicemail | Voicemail Ringback Off]

VMRB+ - Voicemail Ringback On

Switches voicemail ringback for the extension on/off.

This function does not require any data entered when programmed. This function cannot be programmed through the phone by the user.

The  **VMRB+** key toggles voicemail ringback for the extension on/off. When on, **VMRB+** is shown with a  symbol and the extension is called when new messages are left in its mailbox.

[User | Digital Telephony | Advanced | Voicemail | Voicemail Ringback On]

VMCol - Voicemail Collect

Accesses a specified voicemail mailbox to collect or leave messages.

This function requires entry of the target mailbox name prefixed by either ? to collect messages or # to leave a message. If just ? or # is entered then the calling extension's mailbox is assumed. This function cannot be programmed through the phone by the user.

The  **VMCol** key appears followed by the mailbox name.

[User | Digital Telephony | Advanced | Voicemail | Voicemail Collect]

VMOff - Voicemail Off

Disables access to the user's voicemail box.

This function does not require any data entered when programmed. This function cannot be programmed through the phone by the user.



The  **VMOff** key switches voicemail operation for the extension off.

[User | Digital Telephony | Advanced | Voicemail | Voicemail Off]

VMOOn - Voicemail On

Enables/disables access to the user's voicemail box.

This function does not require any data entered when programmed. This function cannot be programmed through the phone by the user.

The  **VMOOn** key toggles voicemail operation for the extension on/off. When voicemail is on, **VMOOn** is shown with a  symbol.

[User | Digital Telephony | Advanced | Voicemail | Voicemail On]

WUTim - Set Wrap Up Time

Sets the extension's busy wrap up time to be inserted between calls.

This function requires the time in seconds to be entered when programmed. The value is shown next to **WUTim**. This function cannot be programmed through the phone by the user.

Pressing  **WUTim** sets the extension's busy wrap up time to the indicated number of seconds. This time is used to set a delay between ending one call and the next call ringing the extension (the waiting call may be indicated on the display however).

[User | Digital Telephony | Advanced | Set | Set Wrap Up Time]

See also:

- NATim - Set No Answer Time on page 43.

System Features

Introduction

As well as your phones specific features, you can access a number of system features by dialing short codes.

These instructions are for the system's default configuration. They assume that you are using the default feature codes. It also assumes that you have full access to all features and the public telephone network

Making Calls

Internal Calls:

If your System Administrator has allocated you the *Ring Back When Free* feature (see page 46) under a dial pad digit, you can:

1. When you call an extension that does not answer or is busy, press the  **RBak** feature key to set a callback on that extension.
2. When the extension you called becomes free, your phone will ring (a burst of three rings).
3. Lift the handset and the extension is called automatically.
4. When the extension you called is free, your phone will ring (a burst of three rings).
5. Lift the handset and the extension is called automatically.

External calls:

To make an external call, either dial the number (prefixed by the access code if required) or use a *speed dial* code (contact your system manager for a list of your speed codes).

If you hear busy tone while dialing, then the call may be barred. Your system manager can bar certain calls, such as those to premium rate numbers and international calls

Answering Calls

Ringling at your own extension:

Simply pick up the handset. When in headset mode, press the button associated with the alerting call.

The default ringing cadences are:

- Internal calls have a single ring cadence
- External calls have a double ring cadence.

These can be changed by your System Administrator.

Ringling at another extension:

You can answer from your own phone by using *Call Pick-Up*; lift your handset and dial:

- ***30** to answer a call ringing anywhere.
- ***31** to answer a call within your group.
- ***32*201#** to answer the call for a particular extension, in this example 201.

Note: If your phone rings for any longer than a specified period (15 seconds in default), any re-direction feature that you have activated, such as voicemail or call forwarding, will come into effect.

Call Waiting

Call Waiting tells you if another call arrives while you are already making a call by providing call waiting tone. If you hear the call waiting tone, either end your current call or put the caller on hold. The waiting call should then ring.

To turn call waiting on use the code ***15**; to turn it off use ***16**.

Call Forwarding

Your calls can be forwarded to another extension or an external number either when you are away from your desk (on no answer), when your extension is busy, and all calls (for example when you go on holiday).

- To switch forward direct station (i.e. not Hunt Group*) calls on dial ***01**, to switch it off dial ***02**.
- To switch forward on busy on dial ***03**, to switch it off dial ***04**.
- To switch forward on no answer on dial ***05**, to switch it off dial ***06**.
- To set the number to which your calls are forwarded dial ***07*201#**, forwarding to 201 in this example.

* To forward Hunt Group Calls On/Off, use ***50** and ***51** respectively.

Diverting Calls

You can divert your calls to another extension.

Note: If you do not answer calls at the temporary extension, they are forwarded to your own voicemail or call forwarding number.

At another extension:

- ***12*N#** from the extension you are temporarily using (where **N** is your extension number). Hence, calls to your extension will be diverted to the extension you are temporarily using.
- ***13*N#** to re-direct the calls back to your own extension, before you return to it.

At your own extension:

- ***14*N#** from your own extension (where **N** is the extension to which you want your calls diverted..)
- ***14*#** to cancel either feature from your own extension.

Do Not Disturb

You may choose to receive no calls at all or only those from particular callers on your exceptions list:

- To switch Do Not Disturb on (with or without exceptions) dial ***08**, to switch it off dial ***09**.
- ***10*N#** to add a number to the exception list.
- ***11*N#** to delete a number from the exception list.

Note: Your callers, other than your exceptions, either hear busy tone or are re-directed to your voicemail.

Voicemail

Where your system has voicemail support and has been installed:

- To switch voicemail on dial ***18**, to switch it off dial ***19**.
- To retrieve your voicemail, use the code ***17**.

Your voicemail may be set up to deliver your messages by calling you whenever you hang up: this feature is known as *Voicemail Ringback*.

- To turn Voicemail Ringback on dial ***48**; to turn it off dial ***49**.

Dialing a number while listening to your messages invokes further facilities:

Once messages have been delivered, they are held on the system for 24 hours (this is fixed for Voicemail Lite, but can be varied by your System Administrator if your IP Office is equipped with VoicemailPro).

You can collect your voicemail from another extension by using the PIN your System Administrator has set up for you. You can collect your messages if you are out of the office, by either dialing from a number that has been registered for the purpose or by dialing your extension number and PIN when prompted. If validation is successful, then dial **1** to retrieve your mail.

The System Administrator also specifies the reception number, to which the call is diverted if the caller dials **0**, and your email address if your voicemail and email are integrated.

Default Feature Codes

The following are the normal default feature codes available to all users. Your System Administrator may change these and/or add additional codes for other features and for speed dials.

The **N** where shown, should be replaced by the appropriate number. For example, with ***07*N#**, replace **N** with the extension to which you want your calls forwarded when you have forwarding switched on.

*00	Cancel All Forwarding	*32*N#	Call Pick Up Extension
*01	Forward Unconditionally On	*33*N#	Call Queue
*02	Forward Unconditionally Off	*34	Hold Music
*03	Forward on Busy On	*35*N#	Extn Login
*04	Forward on Busy Off	*36*N#	Extn Logout
*05	Forward on No Answer On	*37*N#	Park Call
*06	Forward on No Answer Off	*38*N#	Ride Call
*07*N#	Forward to number	*39	Relay On
*08	Do Not Disturb On	*40	Relay Off
*09	Do Not Disturb Off	*41	Relay Pulse
*10*N#	Do Not Disturb Exception Add	*42	Relay On
*11*N#	Do Not Disturb Exception Delete	*43	Relay Off
*12*N#	Follow Me Here	*44	Relay Pulse
*13*N#	Follow Me Here Cancel	*45*N#	Call Steel
*14*N#	Follow Me To	*46	Call Steel
*15	Call Waiting On	*47	Conference Add
*16	Call Waiting Off	*48	Voicemail Ringback On
*17	Voicemail Collect	*49	Voicemail Ringback Off
*18	Voicemail On	*50	Forward Hunt Group Calls On
*19	Voicemail Off	*51	Forward Hunt Group Calls Off
*20*N#	Set Hunt Group Night Service	*52	Clear Call
*21*N#	Clear Hunt Group Night Service	*53*N#	Call Pickup Members
*29	Toggle Calls	*57*N#	Forward on busy number
*30	Call Pick Up Any	*70*N#	Dial Physical Extn by Number
*31	Call Pick Up Group	*71*N#	Dial Physical Extn by ID

EU24 Expansion Module

EU24 Overview

The EU24 Expansion Module is an optional device that can be connected to your 5420 Digital Telephone to extend the number of call appearance and feature buttons available on the telephone.

The expansion module has 24 buttons arranged in two columns. Depending on how they have been programmed by your System Administrator, these buttons can be used for call appearances or features. You can adjust the viewing angle of the EU24 display to match that of your 5420 telephone.

The following figure shows a top view of the EU24 (the left hand column is displayed).



Key:

- 1. Call Appearance/Feature Button
- 2. Feature Active icon for feature in right column
- 3. Alternate Display Button
- 4. Feature Active icon for feature in left column
- 5. Display

Connection

Before you can begin using the EU24 Expansion Module, the module must be connected to the 5420 telephone according to the instructions in the *EU24 Expansion Module Installation and Safety Instructions* (555-233-136).

The following diagram shows an overview of these connections.



Using the EU24 Expansion Module

The following sections explain how to use the features of the EU24 Expansion Module. For more information, consult your System Administrator.

Viewing the Alternate Display

Although the EU24 Expansion Module supports an additional 24 call appearance/feature buttons, it only displays the button labels and icons for one column at a time. A dotted line separates the left column from the right column.

When you are viewing the labels and icons for the left column, the icons for the right column are displayed to the **right** of the dotted line. To view the column not currently displayed, press the Alternate Display button.

Selecting a Call Appearance/Feature Button

To select an available call appearance or feature, press the button next to the label in the column currently displayed.

If the call appearance or feature is not currently displayed, use the Alternate Display key to access the additional 12 call appearance/feature button labels.

Understanding Call Appearance/Feature Button Status Icons

When a call arrives for a call appearance on the EU24 Expansion Module, the bell icon blinks on the corresponding call appearance. To answer the call, press the button associated with the call appearance.

The icons displayed on the call appearance allow you to determine the status (for example, on hold) of each call on the EU24 Expansion Module. Icons also indicate whether a feature has been administered for a particular button on the EU24 Expansion Module. For an explanation of these icons see Call Appearance/Function Key Icons on page 8.

Index

Abbreviated Dial.....	29	Clear Quota.....	46	On Busy On.....	36
Program.....	46	ClrCW	31	On No Answer Off.....	38
Absent Text.....	29	CnfrV	31	On No Answer On.....	38
Absnt.....	29	Conf+	31	Unconditional Off.....	38
Account Code Entry.....	29	Conference		Unconditional On.....	38
Acct.....	29	Add.....	31	FwBNo	36
AD 29		Rendezvous	31	FwBOf.....	36
AD Suppress.....	49	CPark	32	FwbOn	36
Admin.....	29	CPkUp.....	32	FwdH.....	37
Apear	30	CWOff.....	32	FwdH+	37
Appearance.....	30	CWOn	33	FwdOf.....	37
Aquir.....	28	CWSus.....	33	FwNOF.....	38
AutCB.....	30	DCW	33	FwNOn.....	38
Auto-Answer	39	Dial.....	28	FwUOf.....	38
Automatic		CW	33	FwUOn.....	38
Callback.....	30	Direct.....	34	Group	28
Intercom	41	Emergency	35	Disable	40
Busy	30	Inclusion	42	Enable	40
Forward Calls	36	Intercom	42	Forward Calls	37
On Held	30	Physical Extension.....	44	Night Service.....	40
BusyH	30	Dial Tone.....	35	Out of Service	41
Call		Dir 33		Paging.....	38
Appearance.....	30	Dirct.....	34	Pickup.....	45
Forwarding All	31	Directed Call Pickup	35	GrpPg.....	38
Hold.....	41	Directory.....	33	HdSet.....	39
Intrude	42	Display Key		Headset Toggle	39
Listen.....	42	Dial	28	Here-.....	39
Park.....	32, 44	Group	28	Here+	39
Park to Other Extension	44	User.....	28	HfAns	39
Pickup.....	32	DNDOf	34	HGDis	40
Priority	44	DNDOn	34	HGE na	40
Queue.....	46	DNDX-.....	34	HGNS-.....	40
Record.....	47	DNDX+.....	34	HGNS+.....	40
Resume	48	Do Not Disturb		HGOS-.....	41
Retrieve.....	48	Exception Add	34	HGOS+	41
Ride.....	48	Exception Delete	34	Hold.....	41
Steal	50	Off.....	34	Call Waiting	41
Suspend	50	On.....	34	Hold Music.....	43
Timer	51	DpkUp.....	35	HoldCW.....	41
Toggle	51	Drop	28	Hook Flash.....	35
Call Pickup		DTone	35	Hunt Group	28
Any	45	Emergency Dial	35	Disable	40
Directed.....	35	Emrgy.....	35	Enable	40
Group	45	Extn		Forward Calls	37
Members	45	Login.....	42, 43, 47	Night Service.....	40
Call Waiting		Logout	43	Out of Service	41
Clear.....	31	Flash	35	Paging.....	38
Dial	33	Follow Me		Pickup.....	45
Hold.....	41	Here.....	39	IAuto.....	41
Off.....	32	Here Cancel	39	ICSeq	42
On.....	33	To	36	IDial.....	42
Suspend	33, 50	To Number	39	Inclu	42
Callback	30	FoITo.....	36	Inclusion.....	42
Cancel		Forward		Inside Call Sequence.....	42
All Forwarding	37	All	31	Intercom.....	41, 42
Ringback When Free	47	Cancel All	37	Internal Auto-Answer	39
Cfrwd.....	31	Forward Number	37	Intru	28, 42
Clear		Hunt Group Calls Off.....	37	Intrude.....	42
CW	31	Hunt Group Calls On.....	37	Listen	42
Hunt Group Night Service	40	On Busy Number.....	36	Listn	28, 42
Hunt Group Out of Service... ..	41	On Busy Off.....	36	Login	42, 43, 47

Logof.....	43	RBak-.....	47	No Answer Time.....	43
Music.....	43	RBak+.....	46	Outside Call Sequence.....	43
NATime.....	43	RBSeq.....	47	Ringback Sequence.....	47
Night Service.....	40	Recor.....	47	Wrap Up Time.....	52
No Answer		Record Call.....	47	Spres.....	49
Forward Calls.....	38	Relay.....	47	Steal.....	50
Time.....	43	Off.....	48	Suppress.....	49
Number		On.....	47	SusCW.....	50
Follow Me To.....	36	Pulse.....	47	Suspe.....	50
Forward Number.....	37	Rely-.....	48	Suspend	
Forward On Busy.....	36	Rely+.....	47	Call.....	50
OCSeq.....	43	Resum.....	48	Call Waiting Suspend.....	33
On Busy		Resume Call.....	48	CW.....	50
Forward Calls.....	36	Retrieve Call.....	48	Time	
On No Answer		Ride.....	48	No Answer.....	43
Forward Calls.....	38	Ringback		Wrap Up.....	52
Out of Service.....	41	Cancel.....	47	Time of Day.....	51
Outside Call Sequence.....	43	Sequence.....	47	Timer.....	51
Paging.....	38	When Free.....	46	TmDay.....	51
Park.....	32, 44	Ringback Off.....	51	Toggl.....	51
Park to Other Extension.....	44	Ringback On.....	51	Toggle Calls.....	51
PCall.....	44	Ringer Off.....	49	Toggle Headset.....	39
PhyEx.....	44	RngOf.....	49	User.....	28
PickA.....	45	Rtriv.....	48	VMCol.....	52
PickG.....	45	SAC.....	49	VMOff.....	52
PickM.....	45	Secondary Dial Tone.....	35	VMon.....	52
Pickup		Self-Administer.....	29	VMRB-.....	51
Any.....	45	Send All Calls.....	49	VMRB+.....	51
Call.....	32	Sequence		Voicemail	
Directed.....	35	Outside Call.....	43	Collect.....	52
Group.....	45	Ringback.....	47	Off.....	52
Members.....	45	Set		On.....	52
Priority Call.....	44	Absent Text.....	29	Ringback Off.....	51
Prog.....	46	Hunt Group Night Service.....	40	Ringback On.....	51
Queue.....	46	Hunt Group Out of Service.....	41	Wrap Up Time.....	52
Quota.....	46	Inside Call Sequence.....	42	WUTim.....	52

Performance figures and data quoted in this document are typical, and must be specifically confirmed in writing by Avaya before they become applicable to any particular order or contract. The company reserves the right to make alterations or amendments to the detailed specifications at its discretion. The publication of information in this document does not imply freedom from patent or other protective rights of Avaya or others.

Intellectual property related to this product (including trademarks) and registered to Lucent Technologies have been transferred or licensed to Avaya.

All trademarks identified by the ® or ™ are registered trademarks or trademarks, respectively, of Avaya Inc. All other trademarks are the property of their respective owners.

This document contains proprietary information of Avaya and is not to be disclosed or used except in accordance with applicable agreements.

Any comments or suggestions regarding this document should be sent to "wgctechpubs@avaya.com".

© 2005 Avaya Inc. All rights reserved.

Avaya
Sterling Court
15 - 21 Mundells
Welwyn Garden City
Hertfordshire
AL7 1LZ
England

Tel: +44 (0) 1707 392200

Fax: +44 (0) 1707 376933

Email: contact@avaya.com

Web: <http://www.avaya.com>