

Custom Install Product Guide

SPEAKERS & ELECTRONICS



Interactive PDF

Click on product images and text to learn more about products and services

ABOUT MONITOR AUDIO

For over 45 years, **Monitor Audio** has been designing and building award-winning loudspeakers. Since our launch in 1972, we have successfully introduced hundreds of models – from bookshelf speakers to 5.1 home cinema systems to acoustically matched architectural speakers and beyond – and we’re constantly developing and innovating new products to meet our customers’ ever-changing requirements.

A British company from birth, we continue to design and engineer products in our UK-based headquarters, exporting to over 80 countries worldwide.

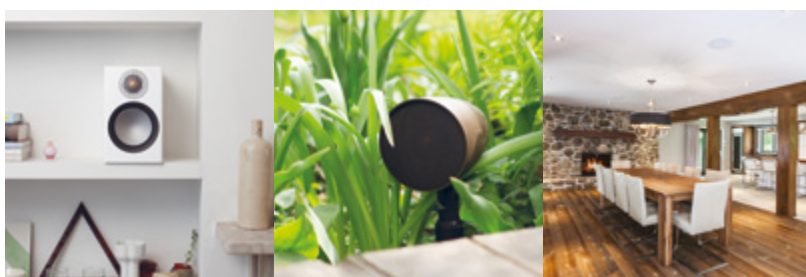

Stereo / Surround sound systems
Custom Install / Architectural speakers



By choosing **Monitor Audio** Custom Install products, you’re securing the utterly desirable combination of seamless integration and superior sound quality, backed by decades of design innovation and award success.

Please refer to our website [monitoraudio.com](https://www.monitoraudio.com)

WHY CHOOSE MONITOR AUDIO CUSTOM INSTALL SOLUTIONS

Monitor Audio's Custom Install products are engineered for high performance, reliability and ease-of-use. They've been developed using the advanced driver technologies of our award-winning hi-fi speaker ranges to deliver world-famous sound quality without compromising room design.

Available across varying performance levels, Monitor Audio's architectural speakers bring innovation to every application – wherever you decide to experience dynamic music and film sound, there's an In-Ceiling or In-Wall speaker that's perfect for the role. The speakers are expertly optimised for rhythmic wideband audio, seamless room integration and easy, secure installation.

If you love your décor and appreciate great audio, you needn't compromise: Monitor Audio's architectural speakers will create harmony all around your home. Every product is designed and built with you firmly in mind.

Main features

Developed using the advanced driver technologies
of our award-winning hi-fi speaker ranges
Audio solutions for diverse spaces and applications
High quality sound performance
Solid and reliable build quality
Patented Tri-Grip mounting clamps
Quick, easy and secure installations
Minimum cut outs
Minimum mounting depths
Magnetic round and square grilles
Vertical or horizontal orientation

Range features





Super Slim and Slim In-Ceiling/In-Wall designs
Back Box solutions
Flush Fit design
Invisible In-Wall speaker
Weather Resistant solutions

CEDIA[™] MEMBER

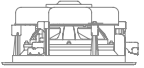

CONTENTS

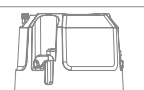
CI Ranges – Click on sections below, to return click on the home button

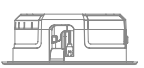
Page		
8	Core (C/W)	 114 mm / 4 ¹ / ₂ "
12	Slim (CS)	 98.6 mm / 3 ⁷ / ₈ "
13	Super Slim (CSS/WSS)	 50 mm / 2"
15	Controlled Performance (CP)	 151 mm / 5 ¹⁵ / ₁₆ "
20	Flush Fit (CF)	 83.5 mm / 3 ⁹ / ₁₆ "
22	Invisible (IV)	Ultimate discretion
24	Platinum II (PL)	Flagship
27	Pro (PRO)	 Commercial 87.7 mm / 3 ⁷ / ₁₆ "
29	All Weather (AWC)	 Weather Resistant 88.5 mm / 3 ¹ / ₂ "
30	Vecta (V)	Weather Resistant
32	Climate	Weather Resistant
33	Climate Garden System (CLG)	Weather Resistant garden speakers
34	Custom Subwoofers	
36	Amplifiers (IA)	
38	Soundbars (SB)	
40	SoundFrame (SF)	
43	Accessories	
46	Specification tables	

CUSTOM INSTALL NAMING SYSTEM

Monitor Audio's Custom Install products are named based on their application, technologies, driver sizes and special features.

Example

C265-IDC

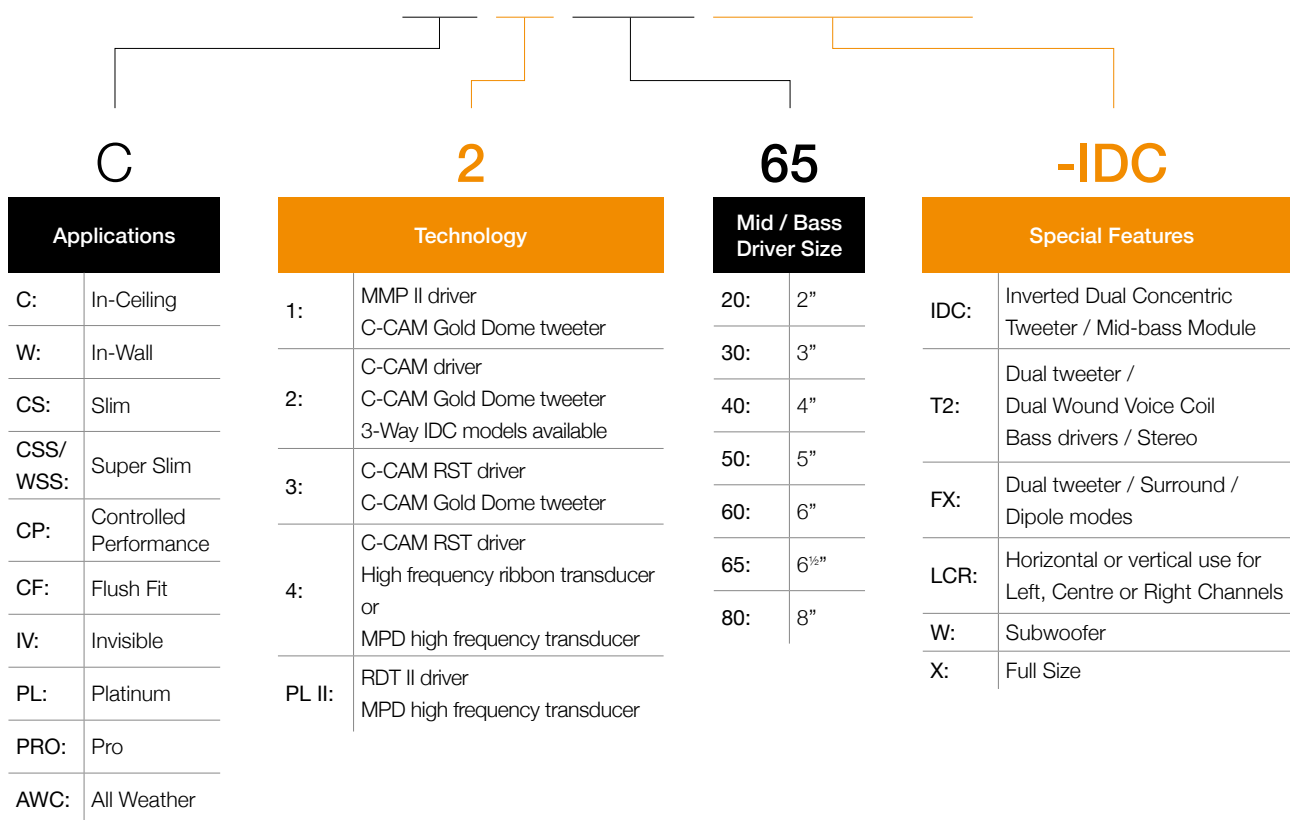

There is explanation of our technology mentioned above on the next page.

TECHNOLOGY

Below is a brief description of each advanced technology used in our award-winning speakers. To achieve a harmony of space and sound for every possible application, we've created a wide range of options across varying performance levels.

DRIVERS

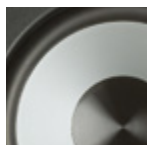

MMP II Driver: Metal Matrix Polymer driver cones have a polypropylene base loaded with metallic particles to offer a rigid and responsive structure.



C-CAM Driver: Ceramic-Coated Aluminium Magnesium cones have a much higher resistance to bending stress and therefore exhibit much greater fidelity over their entire operating range.

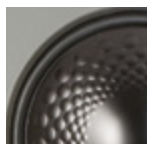

C-CAM RST Driver: Rigid Surface Technology cone developed and perfected using sophisticated computer modelling (Finite Element Analysis). The strengthening effect of RST means that we can use thinner, lighter and more responsive C-CAM cones, providing speed and accuracy with reduced distortion.

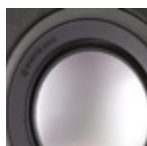

RDT II Driver: Rigid Diaphragm Technology 2nd Generation is a composite 'sandwich' structure made from ultra-thin low mass skins, bonded to a honeycomb Nomex® core material. Very light and very strong, responds with great speed without bending. RDT II uses C-CAM for the front skin, while the rear skin is made from a woven carbon fibre material. This structure reduces distortion by over 8 dB above 300 Hz.

TWEETERS



C-CAM Gold Dome Tweeter: The Gold Dome tweeter is formed from a Ceramic-Coated Aluminium Magnesium alloy, Gold anodised to a specific thickness for ideal stiffness and damping characteristics. Thinner, lighter, more rigid and more efficient than domes made from other materials which are prone to distortion in the audio band.



Ribbon Transducer: An ultra-thin sandwich of C-CAM alloy suspended in a powerful transverse magnetic field of high energy NeFeB rare earth magnets. The ribbon serves as both voice coil and radiating diaphragm, with every part of the ribbon driven directly and simultaneously without energy storage. The diaphragm is specified to reach ultra-high frequencies up to an elusive 100 kHz.



MPD High Frequency Transducer: Micro Pleated Diaphragm high frequency transducer uses a proprietary low-mass pleated diaphragm with a surface area eight times larger than that of a traditional dome tweeter. MPD transducers work like a super-fast accordion by rapidly squeezing the pleats to produce a smooth, wide, naturally fast response up to 100 kHz.

SPECIAL FEATURES

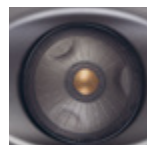

IDC Driver Module: Inverted Dual Concentric pivoting mid-range/tweeter module with up to 18 degrees of adjustment in all directions. Sound can be directed toward the desired listening area.

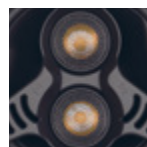

T2 Dual Tweeter Configuration (Stereo): Dual, independent, pivoting 1" C-CAM tweeters and dual wound voice coil bass drivers for high performance stereo sound.

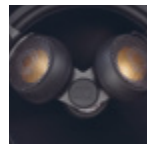

FX Dual Tweeter Configuration (Surround): FX speakers are ideal for surround or rear channel use in home cinema applications for a fully immersive experience.



Adjustable Response Controls: Optimum imaging and set-up are established via pivoting tweeters, pivoting IDC driver modules, high-frequency, mid-range-frequency, and/or boundary compensation controls.



Patented Tri-Grip Mounting Clamps: The Tri-Grip mounting clamps have three clamping points per dogleg. Providing a better seal between the speaker and the ceiling.

Custom Install Speakers



Core

The sonic building block of any custom installation project, our Core line provides a comprehensive selection of models, meticulously developed for specific uses.

In-Ceiling



C165

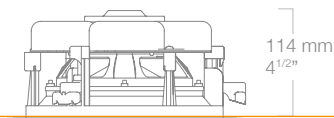

C165-T2

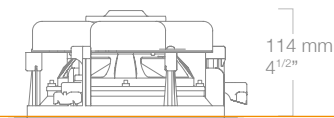

Sensitivity (1W@1m)	88.5 dB	88.5 dB
Cut Out Diameter	211 mm / 8 ^{1/4} "	211 mm / 8 ^{1/4} "
Mounting Depth	114 mm / 4 ^{1/2} "	114 mm / 4 ^{1/2} "
Power Handling (RMS)	65 W	65 W
Impedance	6 ohms	6 + 6 ohms
Driver Size & Technology	6 ^{1/2} " MMP II driver 1" C-CAM pivoting Gold Dome tweeter HF level switch	6 ^{1/2} " MMP II driver 2 x 1" C-CAM pivoting Gold Dome tweeters
Pre-Construction Bracket	CB6 (Purple)	CB6 (Purple)
Back Box	CCBOX-R / CMBOX-R	CCBOX-R / CMBOX-R

C265

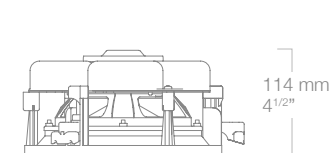

C265-IDC

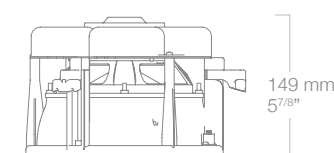

C265-FX

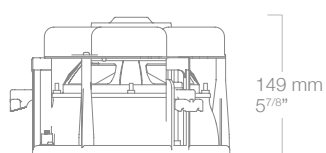

Sensitivity (1W@1m)	88.5 dB	88.5 dB	88.5 dB
Cut Out Diameter	211 mm / 8 ^{1/4} "	211 mm / 8 ^{1/4} "	211 mm / 8 ^{1/4} "
Mounting Depth	114 mm / 4 ^{1/2} "	149 mm / 5 ^{7/8} "	149 mm / 5 ^{7/8} "
Power Handling (RMS)	75 W	85 W	85 W
Impedance	6 ohms	6 ohms	6 ohms
Driver Size & Technology	6 ^{1/2} " C-CAM driver 1" C-CAM pivoting Gold Dome tweeter HF level switch Boundary compensation switch	6 ^{1/2} " C-CAM driver Pivoting IDC module (4" C-CAM RST inverted mid-range driver, 1" C-CAM Gold Dome tweeter) HF level switch Boundary compensation switch	6 ^{1/2} " C-CAM driver 2 x 1" C-CAM Gold Dome tweeters HF level switch Bipole / Dipole switch
Pre-Construction Bracket	CB6 (Purple)	CB6 (Purple)	CB6 (Purple)
Back Box	CCBOX-R / CMBOX-R	CCBOX-L / CMBOX-R	CCBOX-L / CMBOX-R

Core

C180

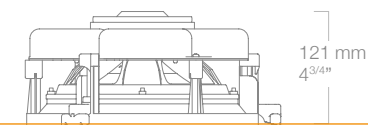

C180-T2

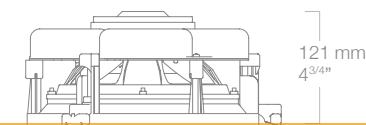

C280

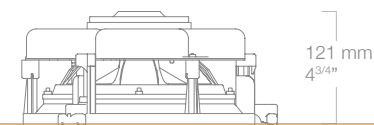

Sensitivity (1W@1m)	90 dB	90 dB	90 dB
Cut Out Diameter	247 mm / 9 ³ / ₄ "	247 mm / 9 ³ / ₄ "	247 mm / 9 ³ / ₄ "
Mounting Depth	121 mm / 4 ³ / ₄ "	121 mm / 4 ³ / ₄ "	121 mm / 4 ³ / ₄ "
Power Handling (RMS)	120 W	120 W	120 W
Impedance	6 ohms	6 + 6 ohms	6 ohms
Driver Size & Technology	8" MMP II driver 1" C-CAM pivoting Gold Dome tweeter HF level switch	8" MMP II driver 2 x 1" C-CAM pivoting Gold Dome tweeters HF level switch	8" C-CAM driver 1" C-CAM pivoting Gold Dome tweeter HF level switch Boundary compensation switch
Pre-Construction Bracket	CB8 (Green)	CB8 (Green)	CB8 (Green)
Back Box	CCBOX-R / CMBOX-R	CCBOX-R / CMBOX-R	CCBOX-R / CMBOX-R

C280-IDC

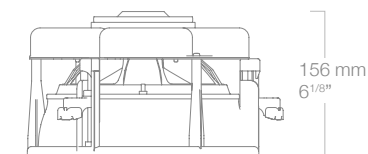

C380-IDC

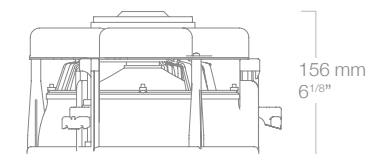

C380-FX

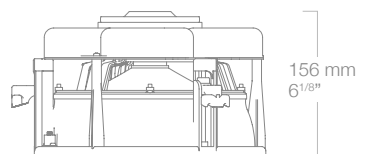

Sensitivity (1W@1m)	90 dB	90 dB	90 dB
Cut Out Diameter	247 mm / 9 ³ / ₄ "	247 mm / 9 ³ / ₄ "	247 mm / 9 ³ / ₄ "
Mounting Depth	156 mm / 6 ¹ / ₈ "	156 mm / 6 ¹ / ₈ "	156 mm / 6 ¹ / ₈ "
Power Handling (RMS)	120 W	150 W	120 W
Impedance	6 ohms	6 ohms	6 ohms
Driver Size & Technology	8" C-CAM driver Pivoting IDC module (4" C-CAM RST inverted mid-range driver, 1" C-CAM Gold Dome tweeter) HF level switch Boundary compensation switch	8" C-CAM RST driver Pivoting IDC module (4" C-CAM RST inverted mid-range driver, 1" C-CAM Gold Dome tweeter) HF level switch Boundary compensation switch	8" C-CAM RST driver 2 x 1" C-CAM Gold Dome tweeters HF level switch Bipole / Dipole switch with additional 12 V trigger switching
Pre-Construction Bracket	CB8 (Green)	CB8 (Green)	CB8 (Green)
Back Box	CMBOX-R	CMBOX-R	CMBOX-R

Core

The sonic building block of any custom installation project, our Core line provides a comprehensive selection of models, meticulously developed for specific uses.

In-Wall Centres

W150-LCR

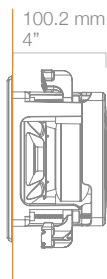

W250-LCR

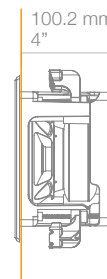

Sensitivity (1W@1m)	88 dB	88 dB
Cut Out Dimensions (H x W)	145 x 353 mm / 5 ^{3/4} " x 13 ^{7/8} "	145 x 353 mm / 5 ^{3/4} " x 13 ^{7/8} "
Mounting Depth	100.2 mm / 4"	100.2 mm / 4"
Power Handling (RMS)	100 W	100 W
Impedance	8 ohms	8 ohms
Driver Size & Technology	2 x 5" MMP II drivers 1" C-CAM pivoting Gold Dome tweeter Fits within standard 400 mm / 16" centre studs	2 x 5" C-CAM drivers 1" C-CAM pivoting Gold Dome tweeter HF level switch Fits within standard 400 mm / 16" centre studs
Pre-Construction Bracket	WB5LCR (Yellow)	WB5LCR (Yellow)



In-Wall

W165

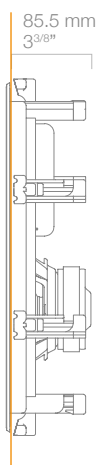

W265

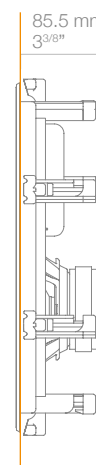

Sensitivity (1W@1m)	88.5 dB	88.5 dB
Cut Out Dimensions (H x W)	332 x 213 mm / 13 ^{1/16} " x 8 ^{3/8} "	332 x 213 mm / 13 ^{1/16} " x 8 ^{3/8} "
Mounting Depth	85.5 mm / 3 ^{3/8} "	85.5 mm / 3 ^{3/8} "
Power Handling (RMS)	65 W	65 W
Impedance	6 ohms	6 ohms
Driver Size & Technology	6 ^{1/2} " MMP II driver 1" C-CAM pivoting Gold Dome tweeter HF level switch	6 ^{1/2} " C-CAM driver 1" C-CAM pivoting Gold Dome tweeter HF level switch Boundary compensation switch
Pre-Construction Bracket	WB6 (Purple)	WB6 (Purple)

Core

W180

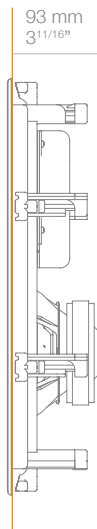

W280

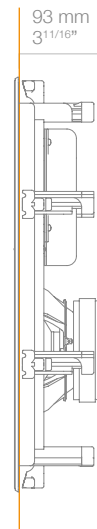

Sensitivity (1W@1m)	90 dB	90 dB
Cut Out Dimensions (H x W)	387 x 234 mm / 15 ^{1/4} " x 9 ^{3/16} "	387 x 234 mm / 15 ^{1/4} " x 9 ^{3/16} "
Mounting Depth	93 mm / 3 ^{11/16} "	93 mm / 3 ^{11/16} "
Power Handling (RMS)	120 W	120 W
Impedance	6 ohms	6 ohms
Driver Size & Technology	8" MMP II driver 1" C-CAM pivoting Gold Dome tweeter HF level switch	8" C-CAM driver 1" C-CAM pivoting Gold Dome tweeter HF level switch Boundary compensation switch
Pre-Construction Bracket	WB8 (Green)	WB8 (Green)
Back Box	WCBOX-L	WCBOX-L

W280-IDC

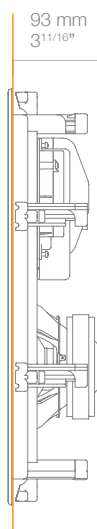

W380-IDC

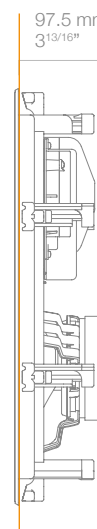

Sensitivity (1W@1m)	90 dB	90 dB
Cut Out Dimensions (H x W)	387 x 234 mm / 15 ^{1/4} " x 9 ^{3/16} "	387 x 234 mm / 15 ^{1/4} " x 9 ^{3/16} "
Mounting Depth	93 mm / 3 ^{11/16} "	97.5 mm / 3 ^{13/16} "
Power Handling (RMS)	150 W	150 W
Impedance	6 ohms	6 ohms
Driver Size & Technology	8" C-CAM driver Pivoting IDC module (4" C-CAM RST inverted mid-range driver, 1" C-CAM Gold Dome tweeter) HF level switch Boundary compensation switch	8" C-CAM RST driver Pivoting IDC module (4" C-CAM RST inverted mid-range driver, 1" C-CAM Gold Dome tweeter) HF & MF level switches Boundary compensation switch
Pre-Construction Bracket	WB8 (Green)	WB8 (Green)
Back Box	WCBOX-L	WCBOX-L

Slim

All of our Slim range speakers – whether used In-Ceiling or In-Wall – have a physical depth of less than 100 mm / 4", making installation in restricted depth, as well as standard stud walls, a trouble-free process.

In-Ceiling / In-Wall

CS140 Round / Square

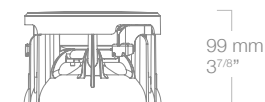

CS160 Round / Square

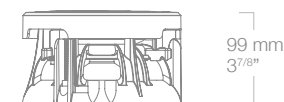

CS180 Round / Square

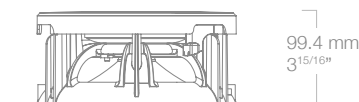

Sensitivity (1W@1m)	85 dB	88 dB	90 dB
Cut Out Diameter	149 mm / 5 ^{7/8} "	170 mm / 6 ^{11/16} "	213 mm / 8 ^{3/8} "
Mounting Depth	99 mm / 3 ^{7/8} "	99 mm / 3 ^{7/8} "	99.4 mm / 3 ^{15/16} "
Power Handling (RMS)	50 W	70 W	120 W
Impedance	6 ohms	6 ohms	6 ohms
Driver Size & Technology	4" MMP II driver 1" C-CAM pivoting Gold Dome tweeter	6" MMP II driver 1" C-CAM pivoting Gold Dome tweeter	8" MMP II driver 1" C-CAM pivoting Gold Dome tweeter
Pre-Construction Bracket	CB4 (Pink)	CB5 (Blue)	CB6 (Purple)
Back Box	CCBOX-R	CCBOX-R / CMBOX-R	CCBOX-R / CMBOX-R

CS140

The CS140 is the entry-point to our In-Ceiling or In-Wall Slim family. All the Slim speakers have a physical depth of less than 100 mm / 4" and we complete them with round or square details – just specify when ordering. The CS140 features a proprietary 4" MMP II cone, plus a pivoting version of our acclaimed C-CAM Gold Dome tweeter.

CS160

Coupling a 6" MMP II driver with a pivoting 25 mm C-CAM Gold Dome tweeter, the CS160 is the mid-model in our Slim In-Ceiling or In-Wall line.

CS180

The CS180 tops our admired Slim In-Ceiling or In-Wall range, marrying the line's pivoting C-CAM Gold Dome tweeter with our 8" MMP II driver.



NOTE : All Slim models can be ordered as a round or square grille option.

Super Slim

Requiring a mounting depth of a mere 50 mm / 2", our Super Slim In-Ceiling speakers are ideal for ceilings with restricted depth settings, creating endless installation opportunities. The range's back box design delivers full frequency performance with a wide installation versatility.

In-Ceiling

CSS230



Sensitivity (1W@1m)	86 dB
Cut Out Diameter	211 mm / 8 ^{1/4} "
Mounting Depth	50 mm / 2"
Power Handling (RMS)	40 W – Full range 60 W – With crossover set to 100 Hz @ 12 dB/Octave
Impedance	8 ohms
Driver Size & Technology	3 x 3" C-CAM drivers, enabling slim profile with the performance of a single 6" driver 3/4" C-CAM pivoting Gold Dome tweeter Sealed rear enclosure for acoustic isolation back box Rubber plug can be removed for open back design and increased low frequency performance
Pre-Construction Bracket	CB6 (Purple)

CSS230

The CSS230 delivers Monitor Audio's signature sound quality from a mounting depth of just 50 mm / 2". Ideal between 2" stud frames, or where pipework or cabling reduces mounting depth, the CSS230 provides the best of both worlds for installer and customer, with the three proprietary 3" mid-bass units combining to achieve the bass output of a 6^{1/2}" driver. Part of our Super Slim series, the CSS230 is a shining example of what many years of speaker design experience produces, enabling hi-fi levels of performance in spaces where no high-quality speaker has gone before.



Closed back

Open back



Super Slim

Requiring a mounting depth of a mere 50 mm / 2", all Super Slim In-Wall speakers are ideal for standard stud walls and restricted depth settings, creating endless installation opportunities. The range's back box design excel in both horizontal and vertical installations, delivering full frequency performance.

In-Wall



Sensitivity (1W@1m)	87 dB	87 dB	87 dB
Cut Out Dimensions (H x W)	346 x 101 mm / 13 ¹ / ₂ x 4"	346 x 101 mm / 13 ¹ / ₂ x 4"	346 x 101 mm / 13 ¹ / ₂ x 4"
Mounting Depth	50 mm / 2"	50 mm / 2"	50 mm / 2"
Power Handling (RMS)	60 W – Full range 100 W – With crossover set to 100 Hz @ 12 dB/Octave	60 W – Full range 100 W – With crossover set to 100 Hz @ 12 dB/Octave)	75 W – Full range 120 W – With crossover set to 100 Hz @ 12 dB/Octave
Impedance	8 ohms	8 ohms	8 ohms
Driver Size & Technology	3 x 3" MMP II drivers, enabling slim profile with the performance of a single 6" driver 1" C-CAM pivoting Gold Dome tweeter	3 x 3" C-CAM drivers, enabling slim profile with the performance of a single 6" driver 1" C-CAM pivoting Gold Dome tweeter	3 x 3" dished C-CAM drivers, enabling slim profile with the performance of a single 6" driver MPD high frequency transducer – rotatable for vertical or horizontal installation
Pre-Construction Bracket	WB3 (Dark blue)	WB3 (Dark blue)	WB3 (Dark blue)

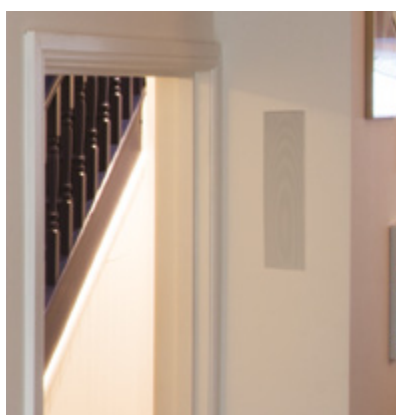

WSS230

WSS130

Our Super Slim design enables wide installation versatility. The WSS130 features three 3" MMP II drivers plus a 1" C-CAM pivoting Gold Dome tweeter, you get the performance of a single 6" driver from a speaker just 140.5 mm wide.



WSS230

This is the middle model in our Super Slim In-Wall range. The WSS230 includes our famed C-CAM metal drivers, making this model ideal for set-ups where critical music reproduction is required.

WSS430

The WSS430 draws on technologies from our high-end Platinum II speakers, including dished C-CAM cones, high-strength Neo magnets and large voice coils to present supreme audio performance. It's flexible, too, with the three-driver layout helping keep the frontal profile slim. Smart touches, such as the ability to rotate the low distortion MPD high frequency transducer to enable optimum dispersion when using the speaker in horizontal orientation, take discreet In-Wall speaker performance to a new level.



Controlled Performance



Regardless of interior ceiling or wall construction, the Controlled Performance range guarantees sonic consistency. We fit all models with fully-sealed back boxes, providing an ideal air load for the drivers and optimising audio performance. These rigid, mineral filled enclosures reduce the sound from the back of the cabinet by around 15 to 22 dB. This range guarantees excellent audio quality and versatility, for superior levels of sound isolation between rooms and floors.

In-Ceiling

CP-CT150

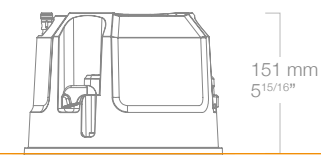

CP-CT260

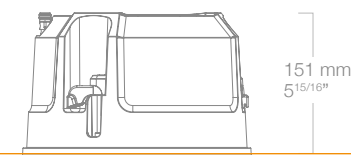

Sensitivity (1W@1m)	85 dB	88 dB
Cut Out Diameter	212 mm / 8 ^{3/8} "	244 mm / 9 ^{5/8} "
Mounting Depth	151 mm / 5 ^{15/16} "	151 mm / 5 ^{15/16} "
Power Handling (RMS)	50 W	65 W
Impedance	6 ohms	6 ohms
Driver Size & Technology	5" MMP II driver 1" C-CAM pivoting Gold Dome tweeter HF level switch	6" C-CAM driver 1" C-CAM pivoting Gold Dome tweeter HF level switch Boundary compensation switch
Pre-Construction Bracket	CB6 (Purple)	CB8 (Green)
Back Box	CCBOX-L	CCBOX-L

CP-CT380

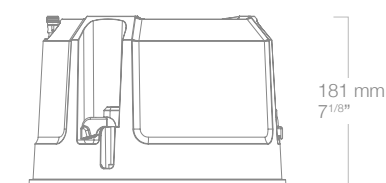

CP-CT380IDC

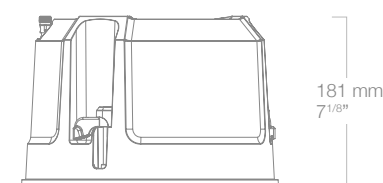

Sensitivity (1W@1m)	89 dB	89 dB
Cut Out Diameter	274 mm / 10 ^{13/16} "	274 mm / 10 ^{13/16} "
Mounting Depth	181 mm / 7 ^{1/8} "	181 mm / 7 ^{1/8} "
Power Handling (RMS)	120 W	120 W
Impedance	6 ohms	6 ohms
Driver Size & Technology	8" C-CAM RST driver 1" C-CAM pivoting Gold Dome tweeter HF level switch Boundary compensation switch	8" C-CAM RST driver Pivoting IDC module (4" C-CAM RST inverted mid-range driver, 1" C-CAM Gold Dome tweeter) HF & MF level switches Boundary compensation switch
Pre-Construction Bracket	CB10 (Light brown)	CB10 (Light brown)

Controlled Performance



In-Wall

CP-WT150

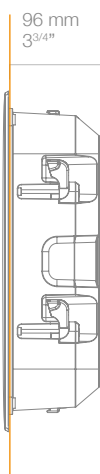

CP-WT260

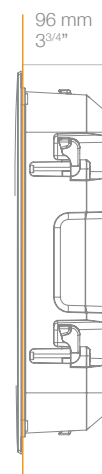

Sensitivity (1W@1m)	85 dB	88 dB
Cut Out Dimensions (H x W)	326 x 207 mm / 12 ^{13/16} " x 8 ^{1/8} "	381 x 228 mm / 15" x 9"
Mounting Depth	96 mm / 3 ^{3/4} "	96 mm / 3 ^{3/4} "
Power Handling (RMS)	50 W	65 W
Impedance	6 ohms	6 ohms
Driver Size & Technology	5" MMP II driver 1" C-CAM pivoting Gold Dome tweeter HF level switch	6" C-CAM driver 1" C-CAM pivoting Gold Dome tweeter HF level switch Boundary compensation switch
Pre-Construction Bracket	WB6 (Purple)	WB8 (Green)
Back Box		WCBOX-L

CP-WT380

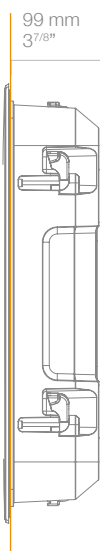

CP-WT380IDC

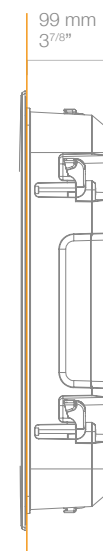

Sensitivity (1W@1m)	89 dB	89 dB
Cut Out Dimensions (H x W)	438 x 269 mm / 17 ^{1/4} " x 10 ^{9/16} "	438 x 269 mm / 17 ^{1/4} " x 10 ^{9/16} "
Mounting Depth	99 mm / 3 ^{7/8} "	99 mm / 3 ^{7/8} "
Power Handling (RMS)	120 W	120 W
Impedance	6 ohms	6 ohms
Driver Size & Technology	8" C-CAM RST driver 1" C-CAM pivoting Gold Dome tweeter HF level switch Boundary compensation switch	8" C-CAM RST driver Pivoting IDC module (4" C-CAM RST inverted mid-range driver, 1" C-CAM gold dome tweeter) HF & MF level switches Boundary compensation switch
Pre-Construction Bracket	WB10 (Light brown)	WB10 (Light brown)

Controlled Performance



In-Wall Centres

CP-WT140LCR

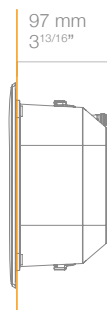

CP-WT240LCR

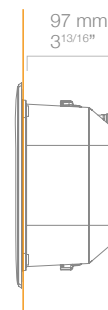

Sensitivity (1W@1m)	88 dB	88 dB
Cut Out Dimensions (H x W)	183 x 299 mm / 7 ³ / ₁₆ " x 11 ³ / ₄ "	183 x 299 mm / 7 ³ / ₁₆ " x 11 ³ / ₄ "
Mounting Depth	97 mm / 3 ¹³ / ₁₆ "	97 mm / 3 ¹³ / ₁₆ "
Power Handling (RMS)	100 W	100 W
Impedance	6 ohms	6 ohms
Driver Size & Technology	2 x 4" MMP II drivers 1" C-CAM pivoting Gold Dome tweeter HF level switch	2 x 4" C-CAM drivers 1" C-CAM pivoting Gold Dome tweeter HF level switch Boundary compensation switch
Pre-Construction Bracket	WB4LCR (Dark brown)	WB4LCR (Dark brown)

In-Ceiling GU10 Size

CPC120

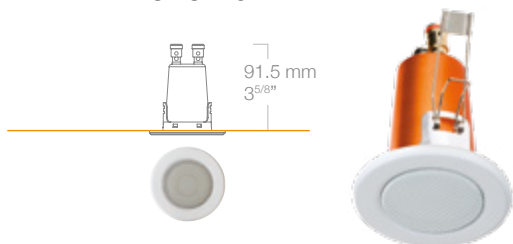

CPC120

A precision engineered micro design; the CPC120 loudspeaker offers extraordinary sound quality from a standard GU10-sized halogen down-lighter hole. It fits on to ceilings with conventional fitment clips meaning quick and simple installation.

Sensitivity (1W@1m)	85 dB
Cut Out Diameter	65 mm / 2 ¹ / ₂ "
Mounting Depth	91.5 mm / 3 ⁵ / ₈ "
Power Handling (RMS)	20 W / 50 W using a crossover @ 200 Hz
Impedance	8 ohms
Driver Size & Technology	2" Full range micro-driver Sealed back box Conventional fitment clips Quick and easy discreet flush fitment to ceilings or walls Available in three finishes (brushed steel, white and brass)

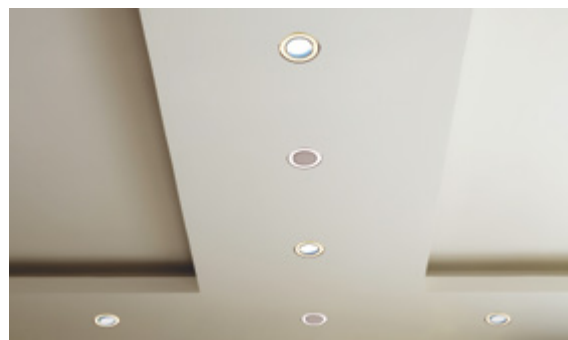

Controlled Performance

Performance Full Size

CP-IW260X

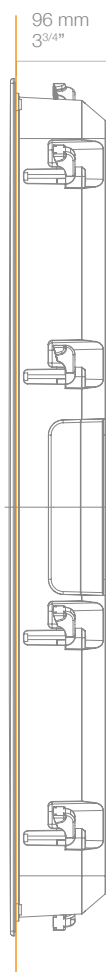

CP-IW460X

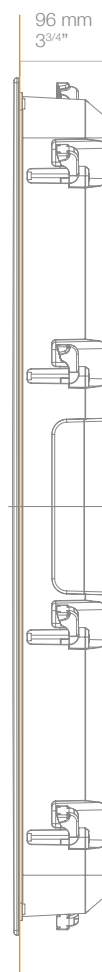

Sensitivity (1W@1m)	89 dB	89 dB
Cut Out Dimensions (H x W)	880 x 230 mm / 34 ^{21/32} " x 9"	880 x 230 mm / 34 ^{21/32} " x 9"
Mounting Depth	96 mm / 3 ^{3/4} "	96 mm / 3 ^{3/4} "
Power Handling (RMS)	150 W	150 W
Impedance	6 ohms	6 ohms
Driver Size & Technology	2 x 6 ^{1/2} " C-CAM bass drivers 2 x 4" C-CAM mid-range drivers 1" C-CAM Gold Dome tweeter HF & MF level switches Boundary compensation switch Vertical or horizontal orientation	2 x 6 ^{1/2} " C-CAM RST bass drivers 2 x 4" C-CAM RST mid-range drivers High frequency ribbon transducer Die-cast alloy bass driver chassis provides rigidity; results in punch bass and clean mid-range performance due to reduced transfer of vibrations HF & MF level switches Boundary compensation switch Innovative HF tweeter rotating system to facilitate vertical or horizontal orientation
Pre-Construction Bracket	WB12 (Green)	WB12 (Green)



Controlled Performance



Performance Full Size

The CP-IW260X and CP-IW460X In-Wall designs have overcome the challenges of scale to deliver the natural, full range audio energy you would expect from a free-standing high-end box. In a leap of engineering ingenuity, we've distilled the know-how driving our hi-fi speakers into a super-compact In-Wall format. Dedicated music lovers and home theatre fans can enjoy the rich, detailed, high-impact dynamics they crave, from a speaker that physically disappears in the room. Both Full Size models can be installed in vertical or horizontal orientations, with the high frequency ribbon transducer of the CP-IW460X designed to rotate 90° to suit the chosen speaker placement.



Flush Fit

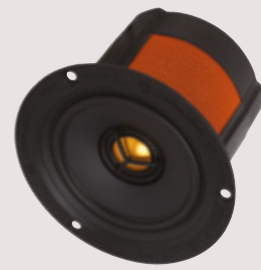

For an architectural Flush Fit finish we have created the beautifully discreet CF230 speaker, designed to blend seamlessly with high-end lighting solutions. Skim over the mudbank with plaster and CF230 aligns with its surrounding area, with a choice of round or square grilles to finish. Use it on its own or in multiples, set up a pair with the matched ICS-8 subwoofer and the 2.1 system will outperform most traditional Custom Install speakers. For existing ceilings use the easy to install Retrofit solution.

In-Ceiling

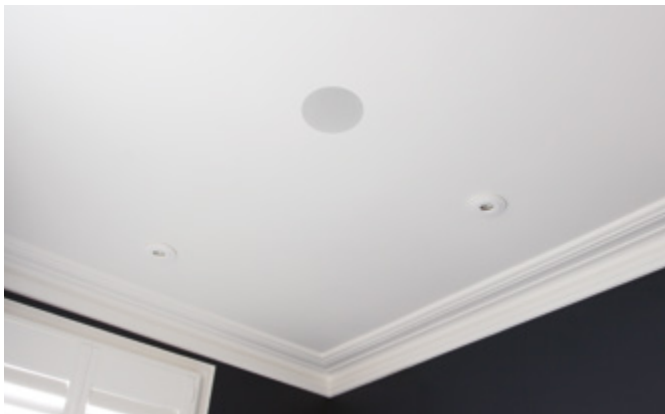

CF230



Sensitivity (1W@1m)	82.5 dB
Cut Out Diameter	Flush Fit 120 mm / 4 ^{3/4} "
	Retrofit 90 mm / 3 ^{5/16} "
Mounting Depth	83.5 mm / 3 ^{5/16} "
Power Handling (RMS)	30 W – Full range – IEC268-5 rating 100 W – Music program (Using High Pass crossover filter @120 Hz)
Impedance	8 ohms
Driver Size & Technology	3 ^{1/2} " Bass/mid-range driver, featuring C-CAM cone 3/4" C-CAM Gold Dome tweeter (Coincident)
Brackets	1. Flush Fit – CFB3-R (round grille) or CFB3-SQ (square grille) Pre-construction bracket included in above kits 2. Retrofit – CFB3-KIT (round and square grilles)
Grille Finish	Signal White, RAL 9003. Also Paintable

CF230

The CF230 is one of Monitor Audio's most visually discreet speaker systems, creating a high-end fit and finish. Choose from Pre-Construction Flush Fit (new build) or Retrofit (existing) installation. Round and square options are on offer, while the option of ceiling mounting or fitting into a standard stud wall construction provide further options.

Used on its own, or in multiples, the CF230 presents beautiful sounding audio from its specially designed coincident driver. Designed and built by people who intimately understand the world of home technology, the CF230 is a given for any custom speaker project.

Pre-Construction Installation

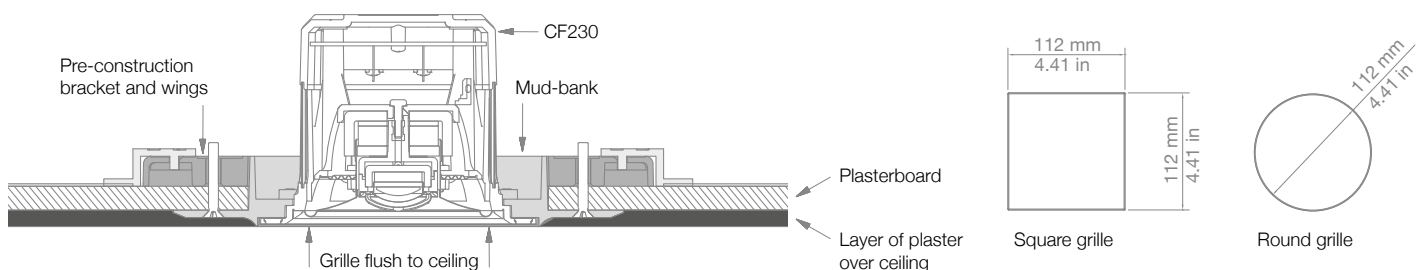

Flush Fit Brackets

1. Pre-Construction Flush Fit

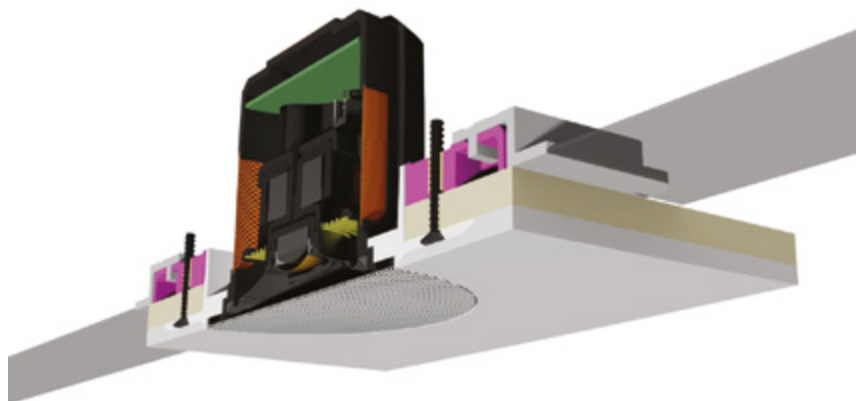
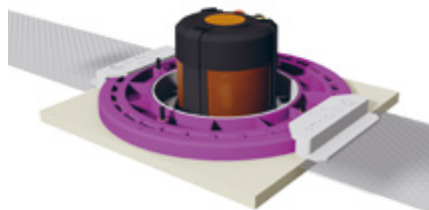

Once skimmed with plaster the pre-construction set-up CF230 package enables a seamless, flush fit appearance. You get clean lines, with no shadow-creating edges, and paint the grille to match the ceiling and the speaker disappears even further into the background. Order either round or square option.

Pre-Construction Flush Fit Installation Packs

CFB3-R (Round)



CFB3-SQ (Square)

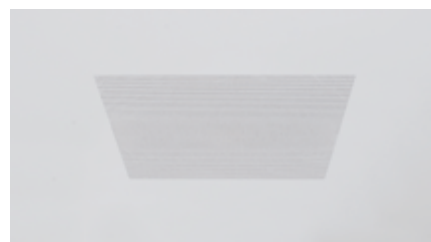
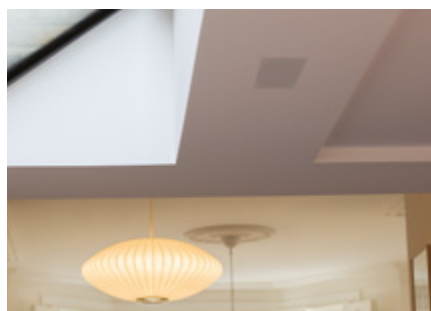
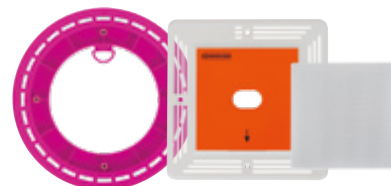

2. Retrofit

CFB3-KIT – Retrofit Bracket

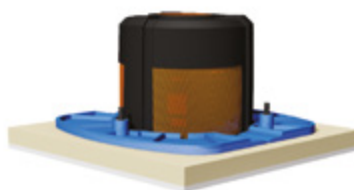
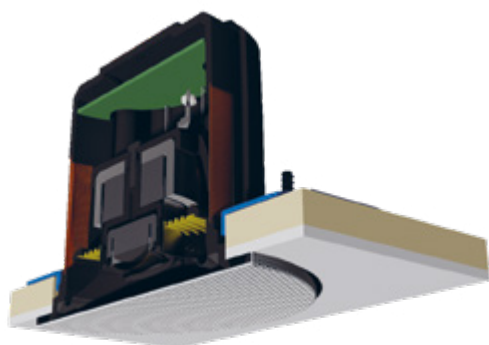

Retrofit: Grille sits proud by 3.55 mm

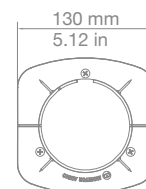

The CFB3-KIT retrofit installation kit cleverly provides a firm fixing behind plasterboard/Sheetrock and requires just three bolts to complete the fit. **NOTE:** The retrofit option is not flush fitting, but requires no plastering. The grille will sit slightly proud of the ceiling surface by 3.55 mm, less than a standard In-Ceiling grille.



Installation Guide video available,
scan the QR code or visit:
vimeo.com/monitoraudio/cf230

ICS-8

Compatible product for this range:
In-Ceiling Subwoofer ICS-8.
[See Page 34 for details.](#)



Invisible

Bringing Monitor Audio's legendary expansive audio performance to any room, the IV140 couldn't be more discreet. Once installed and skimmed with plaster, the two-way speaker disappears completely out of view. Choose to finish the illusion with wallpaper or paint.

In-Wall

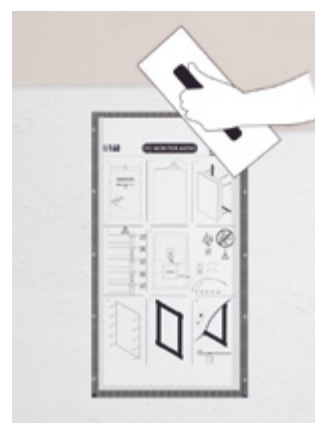

Installation

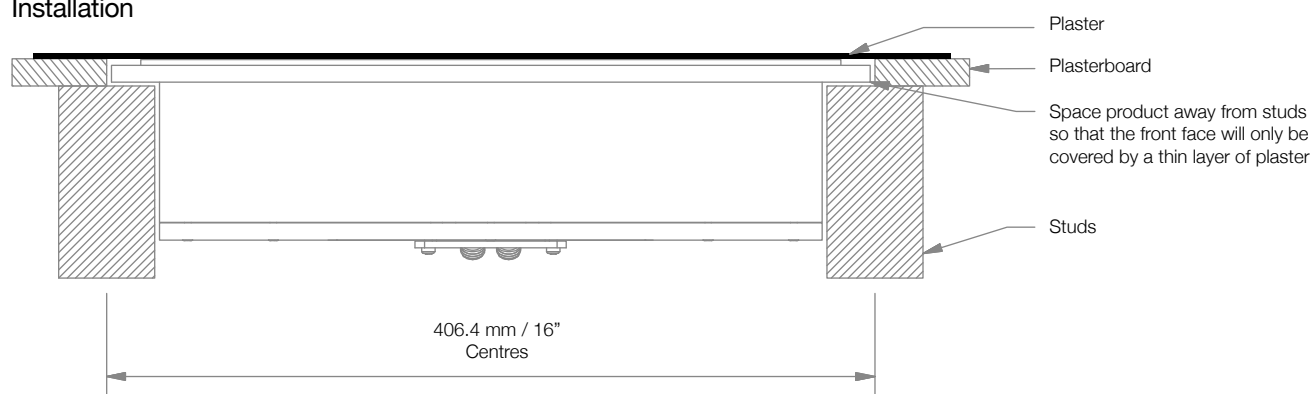

Invisible

IV140

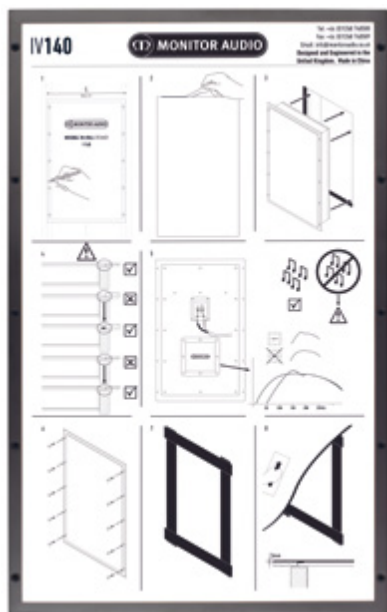

Closed back

Opened back

Rear acoustic cover can be removed

Sensitivity (1W@1m)	82 dB (when installed as directed)
Cut Out Dimensions (H x W)	591 x 350.5 mm / 23 ^{1/4} " x 13 ^{13/16} "
Mounting Depth	83.5 mm / 3 ^{13/16} "
Power Handling (RMS)	50 W – Full range – IEC268-5 rating 100 W – Music program (Using Minimum 80 Hz High Pass filter)
Impedance	8 ohms
Technology	Low frequency transducer – Featuring high power ceramic magnetics and 40 mm voice coil Dual high frequency transducers – Incorporating high power Neo magnets and 30 mm voice coils 2-way system with integrated crossover Pre-construction speaker designed to be plastered in to create 'invisible' appearance Rigid MDF back box construction Integrated 'hybrid' controlled performance back box system – Fully sealed or opened back High Quality crossover – Including metallised film capacitors and low loss steel core inductors Protected against overload by PTC's (automatically re-setting breakers) Ideal for home cinema, distributed audio, hospitality, retail and commercial background music applications where aesthetics and discretion are key factors
Pre-Construction Bracket	WBIV140

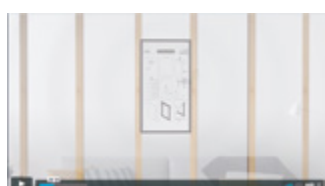

Installation Guide video available, scan the QR code or visit:
vimeo.com/monitoraudio/iv140

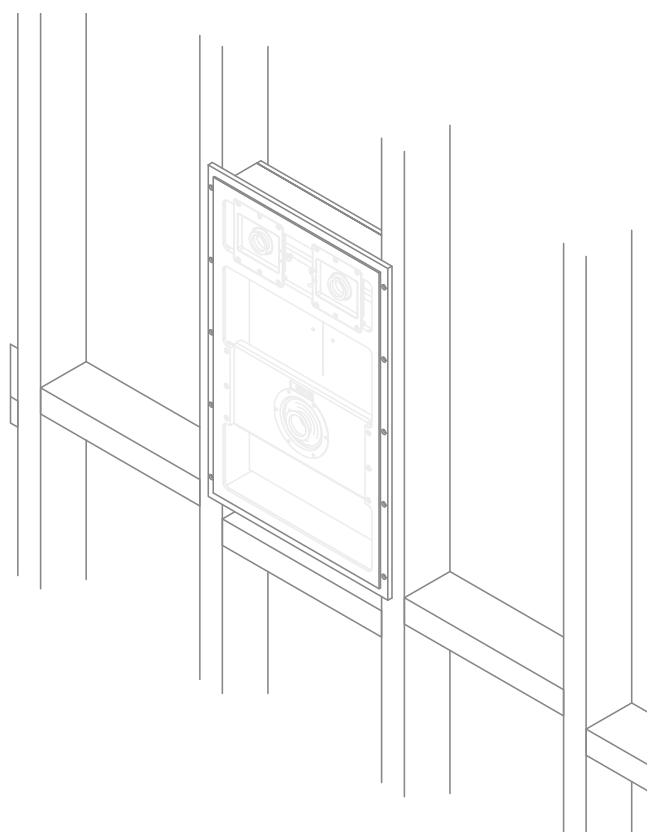



Perfection Elevated

PLATINUM II In-Ceiling Speaker

Platinum II Technology



RDT II (Rigid Diaphragm Technology 2nd Generation) Driver: A composite 'sandwich' structure made from ultra-thin low mass skins, bonded to a honeycomb Nomex® core material. It is very light and very strong, meaning that it can respond with great speed without bending – just like a perfect piston. RDT II uses C-CAM for the front skin, while the rear skin is made from a woven carbon fibre material. We discovered that the new structure reduces distortion by over 8 dB above 300 Hz, which makes RDT II the lowest distortion cone technology in Monitor Audio's history.



MPD (Micro Pleated Diaphragm) High Frequency Transducer: Developed over many months of intensive testing and listening, the MPD High Frequency Transducer is a landmark achievement by the engineering team for Platinum II. It represents an imaginative re-working of an existing technology, transforming a successful idea into an audiophile super-driver, having greater accuracy and efficiency than ever before. Using, proprietary low-mass pleated diaphragm with a surface area eight times larger than that of a traditional dome tweeter. The MPD transducer works like a super-fast accordion by rapidly squeezing the pleats to produce a smooth, wide, naturally fast response up to 100 kHz. As a result it sounds more lifelike, releasing the high harmonic spectrum of every note without the distortion that blurs definition.

PLATINUM II

Platinum II is our flagship range of speakers – the pinnacle of our design skills. With our most advanced driver, crossover and acoustics systems, we've tuned the virtues that have won Monitor Audio worldwide acclaim to deliver sublime audio accuracy. Close your eyes to the flagship custom install speakers and you'll convince yourself that you must be listening to high-end, floorstanders. Open your eyes and guess what? No cabinets on view, just superbly designed In-Ceiling and In-Wall speakers.

In-Ceiling

PLIC II

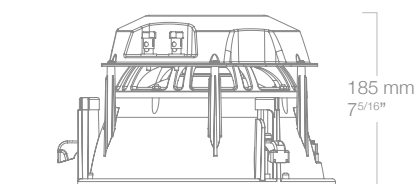

PLIC II

Designed for installation in both new build and retrofit projects, the In-Ceiling option features an 8" long throw bass driver with Rigid Diaphragm Technology (RDT II) cone technology to provide immensely powerful bass lines. To satisfy the interior designer and end user, the circular grille can appear almost invisible, by being painted to match the room décor. This beautiful speaker presents a stunning example of how to successfully marry high-end audio performance with installation flexibility.

Sensitivity (1W@1m)	90 dB
Cut Out Diameter	273 mm / 10 ^{3/4} "
Mounting Depth	185 mm / 7 ^{5/16} "
Power Handling (RMS)	150 W
Impedance	4 ohms Nominal (3.1 ohms minimum @ 1.1 kHz)
Driver Size & Technology	8" long-throw RDT II bass driver 2 x 2" C-CAM mid-range drivers – full three-way design MPD high frequency transducer Angled mid-range and high frequency drivers – directed towards listening area to provide uniform mid and high frequency dispersion High-performance 'no compromise' flagship speaker product Rigid aluminium baffle construction Highest quality 'push' style termination Mid-range and HF level adjustment switches (+1/0/-1 dB) Paintable, trim less/low profile circular magnetic grille design Square grille option available Highest quality crossover design – including metallised polypropylene capacitors and low loss inductors Patented Tri-Grip mounting clamps
Pre-Construction Bracket	CB10 (Light brown)
Back Box	PLIC-BOX II – specially designed pre-construction enclosure provides ideal controlled performance or a bespoke sealed enclosure of 24 Litres

Platinum II In-Ceiling Back Box



Overall Dimensions
(Including Brackets):
191.2 x 628.6 x 350 mm
7^{1/2} x 24^{3/4} x 13^{3/4}"
Internal volume 24 L



PLIC-BOX II

To ensure controlled audio performance for the PLIC II, Monitor Audio has designed an optional pre-construction MDF back box with pre-determined air volume of 24 L. The rigid box is available with pre-loaded internal damping material to provide the best possible sound absorption and reduce standing waves.

PLATINUM II

In-Wall

Platinum In-Wall II

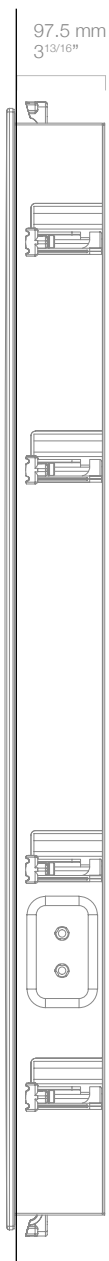

Platinum In-Wall II can be installed in vertical or horizontal orientations

Platinum In-Wall II

The Platinum In-Wall II is a three-way reference architectural speaker system, perfect for custom home theatre projects where lifelike scale and dynamics are demanded. Equipped with an adjustable mid/high frequency driver array, this unit is able to deliver pin-point audio imaging and consistency from both vertical or horizontal orientations. By rotating the array though 90 degrees at the centre of a LCR configuration for instance, a soundstage of three Platinum In-Wall II's will generate the seamless tonal integrity of the finest boxed systems from a stealthy In-Wall location.

Sensitivity (1W@1m)	90 dB
Cut Out Dimensions (H x W)	1175 x 300 mm / 46 ^{1/4} x 11 ^{13/16} "
Mounting Depth	97.5 mm / 3 ^{13/16} "
Power Handling (RMS)	200 W
Impedance	4 ohms (3.7 ohms min. @ 2.8 kHz)
Driver Size & Technology	2 x 6 ^{1/2} " RDT II bass drivers 4" RDT II mid-range driver MPD high frequency transducer Mid-range/tweeter module rotates for vertical or horizontal orientations HF & MF level switches (+1/0/-1 dB) Flagship In-Wall luxury speaker Less than 4" mounting depth



Pro Speakers



In-Ceiling

We purposely designed the PRO Speakers range for projects requiring a large number of compact discreet speakers. Combining brilliant sonic performance with a highly flexible architectural design, PRO models work perfectly in larger spaces, including hotel lobbies, office complexes, restaurants, as well as general domestic set-ups.

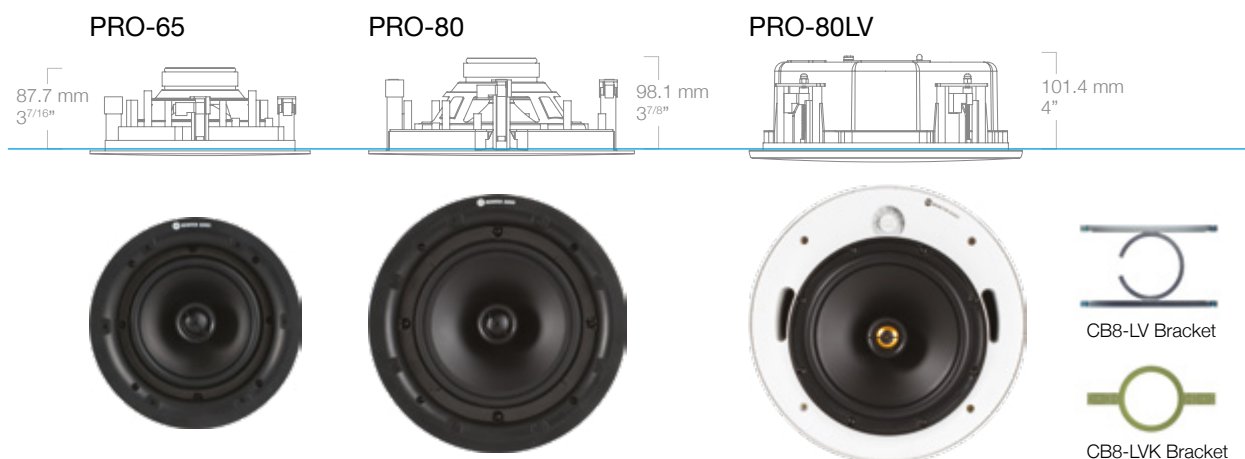

Sensitivity (1W@1m)	86 dB	87 dB	87 dB
Cut Out Diameter	205 mm / 8 1/16"	248 mm / 9 3/4"	266 mm / 10 1/2"
Mounting Depth	87.7 mm / 3 7/16"	98.1 mm / 3 7/8"	101.4 mm / 4"
Power Handling (RMS)	30 W	40 W	40 W
Impedance	8 ohms	8 ohms	16 ohms 70 V (4, 8, 16, 32, 64 W) / 100 V (8, 16, 32, 64 W) power selection
Driver Size & Technology	6 1/2" MMP II driver 1" pivoting tweeter Only available in packs of 5	8" MMP II driver 1" pivoting tweeter Only available in packs of 5	8" MMP II driver 1" C-CAM Gold Dome tweeter Ideal for projects with a large quantity of speakers over large distances Transformer with 70/100 V input for installation on one amplifier channel Fireproof steel rear can – Fire Rating: UL1480 & UL2043 'Easy-fit' connection block – Provides link out for 'daisy chain' connection Anchor point fixings Only available in packs of 4
Pre-Construction Bracket	PRO-IC65 Construction Bracket	CB8 (Green)	CB8-LV CB8-LVK

PRO-65

Available in packs of five, and part of our PRO range, the PRO-65 is ideal for projects with large numbers of compact speakers. It twins our 6.5" MMP II cone bass-mid driver with the pivoting 25 mm fabric dome tweeter.

PRO-80

Available in packs of five, and part of our PRO range, the PRO-80 is an essential part of any project requiring large numbers of compact In-Ceiling speakers. It twins our 8" MMP II driver – this is tried and thoroughly trusted Monitor Audio technology – with our pivoting 25 mm fabric dome tweeter.

PRO-80LV

A commercial speaker with 70/100 V line power taps, the Monitor Audio PRO-80LV is ideal for projects with a large quantity of speakers extending over large distances. With its 'Easy-fit' connection box providing link out for 'daisy chain' connection, and equipped with our C-CAM Gold Tweeter and 8" MMP II driver, it is as sonically capable as it is useful.

Weather Resistant Speakers



All Weather

Our All Weather In-Ceiling series means Monitor Audio performance in extreme environments, such as bathrooms, beach houses, boats, and saunas. Equipped to resist heightened levels of corrosion, dust, and water, the All Weather line also offers UV protection. Even the non-ferrous Samarium Cobalt magnets and the Stainless Steel grilles are certified against salt spray. Operating temperature range: -34° to 79° C / -29° to 174° F.



In-Ceiling

AWC265

AWC265-T2

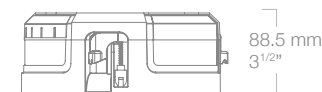
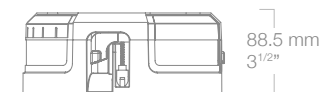

Sensitivity (1W@1m)	88 dB	88 dB (both channels driven)
Cut Out Diameter	211 mm / 8 ¹ / ₄ "	211 mm / 8 ¹ / ₄ "
Mounting Depth	88.5 mm / 3 ¹ / ₂ "	88.5 mm / 3 ¹ / ₂ "
Power Handling (RMS)	60 W	2 x 50 W
Impedance	8 ohms / 4.4 ohms @ 190 Hz	8 + 8 ohms / 4.5 ohms @ 185 Hz
Driver Size & Technology	6 ¹ / ₂ " C-CAM driver 1" C-CAM Gold Dome tweeter HF level switch	6 ¹ / ₂ " C-CAM driver 2 x 1" C-CAM Gold Dome tweeters HF level switch
IP Rating	Front: IP55 Rear: IP4X	Front: IP55 Rear: IP4X
Pre-Construction Bracket	CB6 (Purple)	CB6 (Purple)
Back Box	CCBOX-R / CMBOX-R	CCBOX-R / CMBOX-R



Gold plated push terminals with silicone cover

AWC280

AWC280-T2

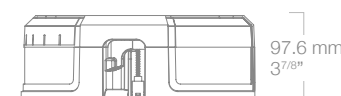
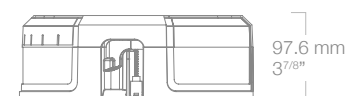

Dust protection covers on driver and crossover splash and humidity proof for installation in shower and pool areas

Sensitivity (1W@1m)	89 dB	89 dB (both channels driven)
Cut Out Diameter	247 mm / 9 ³ / ₄ "	247 mm / 9 ³ / ₄ "
Mounting Depth	97.6 mm / 3 ⁷ / ₈ "	97.6 mm / 3 ⁷ / ₈ "
Power Handling (RMS)	100 W	2 x 50 W
Impedance	8 ohms / 4.5 ohms @ 185 Hz	8 + 8 ohms / 4.5 ohms @ 185 Hz
Driver & Technology	8" C-CAM driver 1" C-CAM Gold Dome tweeter HF level switch	8" C-CAM driver 2 x 1" C-CAM Gold Dome tweeters HF level switch
IP Rating	Front: IP55 Rear: IP4X	Front: IP55 Rear: IP4X
Pre-Construction Bracket	CB8 (Green)	CB8 (Green)
Back Box	CCBOX-R / CMBOX-R	CCBOX-R / CMBOX-R



Stainless steel fixing screws with Neoprene covers

Vecta



The stylish, compact and versatile Monitor Audio Vecta V240 indoor or outdoor speaker cleverly combines architectural aesthetics with innovation and the high quality professional audio performance that the company is renowned for. The Vecta V240 offers incredible versatility and simple installation, ensuring integrators can install these systems quickly and effectively. Developed with an angled baffle and curved tapered back cabinet, Vecta is designed to provide a wider field of coverage for an optimal acoustic performance. The V240 blends seamlessly under eaves or in vertical corners, UV resistant finishes in black or white. Operating temperature range: -25° to 65° C / -13° to 149° F.

Wall / Corner Mounted

V240

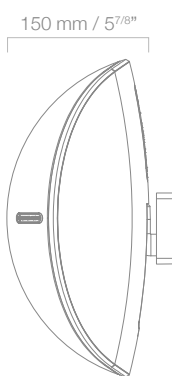

Sensitivity (1W@1m)	88 dB
Overall Dimensions With Grille (H x W x D)	335.9 x 243.2 x 150 mm / 13 ^{1/4} x 9 ^{9/16} x 5 ^{7/8} " (Overall Depth with Bracket: V-MOUNT 175.4 mm / 6 ^{7/8} ")
Power Handling (RMS)	100 W
Impedance	4 ohms
Driver Size & Technology	2 x 4" C-CAM drivers 1" C-CAM Gold Dome tweeter Stylish, compact, and versatile architectural 'Weather Resistant' design Sealed enclosure impervious to 'all weather' environments – Rated to IP55 Intelligent automatic connection system – easier to install with no visible wires Straight wall mount bracket V-MOUNT – providing 25° tilt (optional wedge adds extra 32.5°. Total Max: 45°.) Corner bracket V-CORNER for corner or under eave installation Up to eight installation configurations High-density ABS enclosure with rust proof grille Paintable to match a custom installation
Mounts	V-MOUNT or V-CORNER (Sold Separately)
IP Ratings	IP55

V240

Using cleverly designed brackets and a single point automatic connection system, Vecta can be quickly and easily mounted horizontally or vertically. Installers fix the bracket to the wall, and then simply drop the speaker in place and secure with a single screw. An automatic connection system means that the install is extremely sleek, with no wires visible.

V-MOUNT

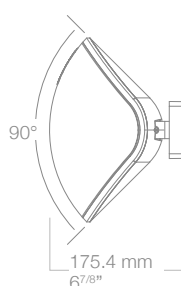

V-MOUNT with Wedge

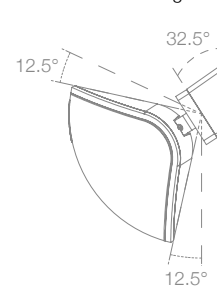

V-CORNER

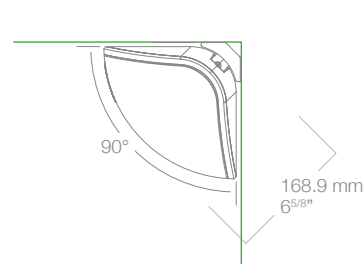

Vecta

Brackets and mounting configurations



V-MOUNT



V-CORNER

V-MOUNT

Vecta V-MOUNT brackets enable wide audio dispersion, allowing the speaker to be angled by 25° or tilted a further 32.5° with the optional wedge.

V-MOUNT Bracket



V-MOUNT



Cover removed



V-MOUNT with optional wedge

V-CORNER

By using a Vecta V-CORNER bracket, speakers can be installed under eaves or in the corner of the wall, providing high quality audio from a discreet location.

V-CORNER Bracket



V-CORNER



Cover removed



V240 back



Cross section



Finishes:

V240 and V-Mount

UV resistant Black or White
(Signal White, RAL 9003)

V-Corner: Black



Mounted flat on a wall – horizontal



Mounted flat on a wall – vertical



Mounted with optional Wedge

Installation Guide video available, scan the QR code or visit: vimeo.com/monitoraudio/vecta

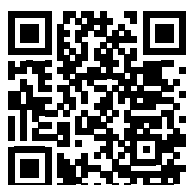

Mounted in a corner



Mounted under eaves



2 x Mounted back to back

Climate

Certified resistant to corrosion, UV, and water our Climate range lets you experience Monitor Audio speaker performance outdoors, whatever the weather. Wall mountable, the robust cabinet presents a smart look as well as disperses quality audio over large areas. Paintable textured black or white finishes with weatherproof aluminium grilles.

Operating temperature range: -25° to 65° C / -13° to 149° F.

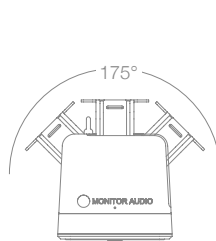

Bracket allows for 175° rotation on horizontal axis



Speaker position can be fine tuned by using optional 15° angle block



Vertical or horizontal orientation. Rotational 'M' logo

Wall Mounted



Climate 50

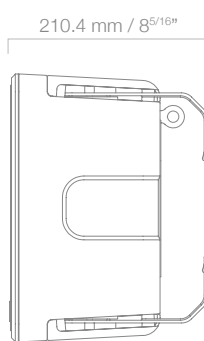

Climate 60

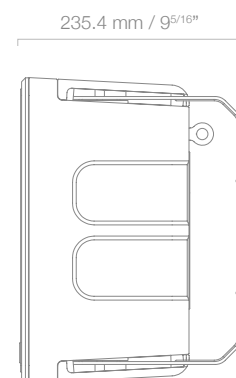

Sensitivity (1W@1m)	87 dB	88 dB
Overall Dimensions With Grille (H x W x D)	285 x 172.5 x 160 mm / 11 ¹ / ₄ x 6 ¹³ / ₁₆ x 6 ⁵ / ₁₆ " (Overall Depth With Bracket: 210.4 mm / 8 ⁵ / ₁₆ "	325 x 185 x 180 mm / 12 ¹³ / ₁₆ x 7 ⁵ / ₁₆ x 7 ² / ₁₆ " (Overall Depth With Bracket: 235.4 mm / 9 ⁵ / ₁₆ "
Power Handling (RMS)	80 W	100 W
Impedance	8 ohms	8 ohms
Driver Size & Technology	5 ¹ / ₂ " C-CAM driver 1" C-CAM Gold Dome tweeter Rear mounted ABR (Auxiliary bass radiator)	6 ¹ / ₂ " C-CAM driver 1" C-CAM Gold Dome tweeter Rear mounted ABR (Auxiliary bass radiator)
IP Ratings	IP55	IP55

Climate 80

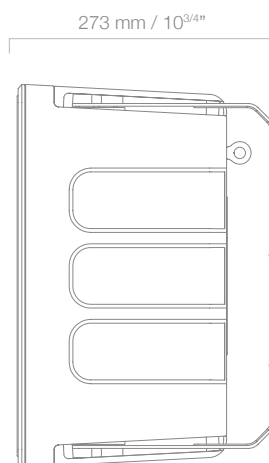

Climate 60-T2

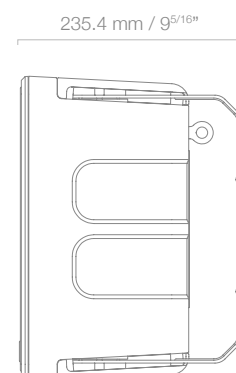





Finishes
 Textured White
 and Black

Sensitivity (1W@1m)	89.5 dB	88 dB
Overall Dimensions With Grille (H x W x D)	405 x 230 x 221.5 mm / 15 ¹⁵ / ₁₆ x 9 ¹ / ₁₆ x 8 ¹² / ₁₆ " (Overall Depth With Bracket: 273 mm / 10 ³ / ₄ "	325 x 185 x 180 mm / 12 ¹³ / ₁₆ x 7 ⁵ / ₁₆ x 7 ² / ₁₆ " (Overall Depth With Bracket: 235.4 mm / 9 ⁵ / ₁₆ "
Power Handling (RMS)	120 W	2 x 50 W
Impedance	8 ohms	8 + 8 ohms
Driver Size & Technology	8" C-CAM driver 1" C-CAM gold dome tweeter Rear mounted ABR (Auxiliary bass radiator)	6 ¹ / ₂ " C-CAM driver 2 x 1" C-CAM Gold Dome tweeters T2: Stereo with double tweeter Rear mounted ABR (Auxiliary bass radiator)
IP Ratings	IP55	IP55

Climate Garden System

Ingeniously designed for concealment in any garden landscape, the Climate Garden System transfers our award-winning hi-fi audio quality from home to garden, providing music lovers with the lifestyle experience of big, wide, detailed sound in the great outdoors.

The system's super-discreet all-weather satellite/subwoofer design has been beautifully and expertly created by our designers for ground level installation amongst shrubs and trees. The resulting speakers deliver a luxurious blend of unobtrusive aesthetics and natural full-range audio in gardens of any size.

Comprising the CLG140 and CLG160 satellite speakers and the CLG-W12 subwoofer 'daisy-chained' together in 70/100 V line arrays of up to twelve satellites per subwoofer, the set-up is expandable with additional satellite and subwoofer sets according to garden area. Operating temperature range: -20° to 70° C / -4° to 158° F.



In-Ground / Mounted

CLG140

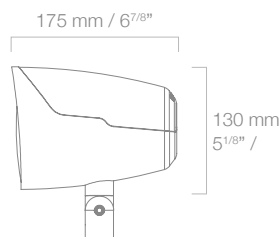

CLG160

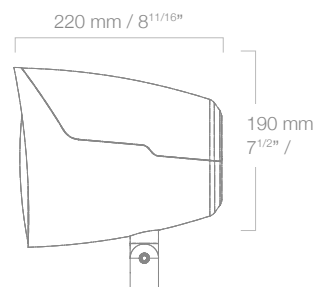

Sensitivity (1W@1m)	88 dB	89 dB
Overall Dimensions Excluding Mount/Spike (H x W)	130 x 175 mm 5 1/8" x 6 7/8"	190 x 220 mm 7 1/2" x 8 11/16"
Power Handling (RMS)	40 W (Crossover set to minimum 100 Hz @ 12 dB/Octave)	60 W (Crossover set to minimum 80 Hz @ 12 dB/Octave)
Impedance	70/100 V line level	70/100 V line level
Driver Size & Technology	4" MMP II cone bass-mid driver 1" C-CAM Gold Dome tweeter – Coaxially oriented	6" MMP II cone bass-mid driver 1" C-CAM Gold Dome tweeter – Coaxially oriented
IP Ratings	IP55	IP55

NOTE : Mount and Spike sold separately. Speakers not included. Tree or pole mounting possible with additional fixings.



CLG-SPIKE R



CLG-MOUNT



CLG-W12 below ground garden installation. On patios or decks install within a suitably sized planter.



CLG-W12 Subwoofer

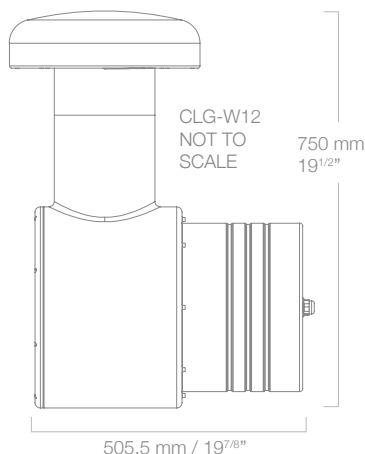

Sensitivity (1W@1m)	87 dB
Overall Dimensions (H x W x D)	750 x 380 x 505.5 mm / 19 1/2" x 14 15/16" x 19 7/8"
Power Handling (RMS)	250 W
Impedance	4 ohms or 70/100 V line level (cable select)
Driver Size & Technology	12" C-CAM cone, long throw sub-bass driver
IP Ratings	IP54

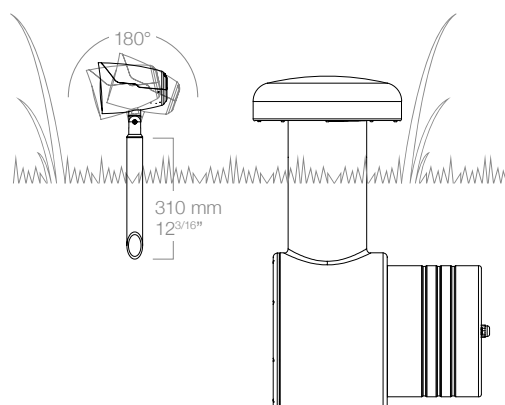

Custom Subwoofers

Free Standing



CW8 and CW10

The ultra-compact CW8 and CW10 subwoofers generate amazingly distinct bass from remarkably inconspicuous enclosures.

CW8



CW10



Input Impedance	> 20 K ohms	> 20 K ohms
Cabinet Dimensions (H x W x D)	270 x 260 x 276 mm 10 ^{5/8} x 10 ^{1/4} x 10 ^{7/8} "	315 x 305 x 320 mm 12 ^{3/8} x 12 x 12 ^{5/8} "
Driver Size	8" C-CAM long throw driver 2 x 8" ABRs	10" C-CAM long throw driver 2 x 10" ABRs
Technology	Two, side mounted ABRs (Auxiliary bass radiators) to increase output and reduce distortion Tuned for High SPL and impact IR sensor for remote control (Published feature codes) RS-232 for integration with system controllers (Published feature code) USB P.C. application for full feature adjustment and installer set-up LFE Balanced XLR Input and unbalanced RCA Stereo RCA line level inputs Phase and power mode switches Auto standby (signal sensing) and 12 V trigger 4 pre-set EQ's optimised for: Flat, Music, Movie and Impact with customisation using application Robust metal mesh grille Rigid MDF cabinet construction with durable vinyl finish	
Amplifier Power Output	350 W RMS @ < 1% THD+N	400 W RMS @ < 1% THD+N
Amplifier Classification	Class D amplifier with switch mode power supply (SMPSU)	Class D amplifier with switch mode power supply (SMPSU)



In-Ceiling

ICS-8

A high-performance subwoofer able to fit into discreet spaces, such as ceiling and wall cavities, we primarily developed the ICS-8 to complement the CF230 Flush Fit In-Ceiling speaker. The 8" driver has been angled internally in the rigid MDF enclosure, to reduce the overall box height and ensure compatibility with a wide range of standard construction cavities. This smartly specified subwoofer delivers powerful bass down to 40 Hz and the sealed bandpass enclosure design stops ingress of dirt and building materials.

Sensitivity (1W@1m)	85 dB
Overall Cabinet Dimensions (H x W x L):	235 x 280 x 396 mm 9 ^{1/4} x 11 x 15 ^{3/16} "
Power handling	150 W – Full range – IEC268-5 rating
Impedance (nominal)	8 ohms
Driver Size & Technology	8" long throw bass driver, featuring C-CAM cone technology
Pre-Construction Bracket	CFB3-R (round grille) or CFB3-SQ (square grille) Pre-construction bracket included in above kits

ICS-8



Pre-Construction Flush Fit Brackets

The ICS-8 is installed using one of these brackets. Order either round or square option.



CFB3-R (round)



CFB3-SQ (square)

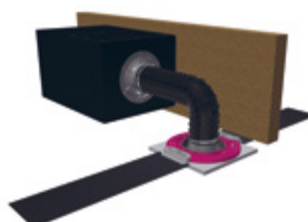

Installation Guide video available, scan the QR code or visit:

vimeo.com/monitoraudio/ics8

Custom Subwoofers

Designed to perfectly complement our In-Ceiling and In-Wall speakers, the Custom Subwoofer range brings added bass reach, yet demands little in the way of footprint. Choose from ultra-compact free-standing designs, In-Wall or In-Ceiling models.

In-Wall

Our In-Wall Subwoofer design marries the IWS-10 subwoofer driver, IWA-250 amplifier, and IWB-10 black box. Use the IWS-10 model in a range of ceiling, floor, and In-Wall locations, ideally – but not exclusively – with its IWB-10 back box.



IWS-10

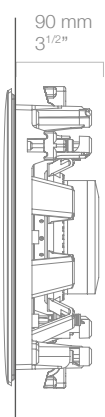

Sensitivity (1W@1m)	86 dB
Cut Out Dimensions (H x W)	280 x 280 mm / 11 x 11"
Mounting Depth	90 mm / 3 ¹ / ₂ "
Power Handling (RMS)	150 W
Impedance	8 ohms
Driver Size & Technology	10" C-CAM RDT driver Less than 4" mounting depth Ideally but not exclusively pairs with its IWB-10 back box Patented Tri-Grip mounting clamps
Back Box	IWB-10 (In-Wall Back Box)

IWB-10 (In-Wall Back Box)



IWB-10 shown with installed IWS-10 and grille

Overall Dimensions (H x W x D) :
850 x 351 x 85 mm / 33¹/₂ x 13¹³/₁₆ x 3¹¹/₃₂"
Internal volume 16.5 L
Designed to provide optimum performance for IWS-10
Fits into standard 14" stud bays (16" centres)
Reduces the radiation of sound to adjacent rooms
Heavy duty MDF construction
Rugged laminated vinyl finish
Pre-wired with external high quality push type terminals
Supplied with mounting brackets for installation

85 mm
3¹¹/₃₂"



IWA-250 Amplifier



Input Impedance	> 20 K ohms
Overall Dimensions (H x W x D):	43.7 x 432 x 263 mm 1 ³ / ₄ x 17 x 10 ³ / ₈ "
Technology	Heavy-duty 1U rack mount case Will power single or dual IWS-10s Switch mode power supply DSP controlled with advanced limiters <0.5 W standby power consumption (ErP certified) DC short circuit protection, over-current and thermal protection Supplied with rack mounting brackets for installation
Amplifier Power Output	250 W @ < 1% THD+N
Amplifier Classification	Class D amplifier with Switch mode power supply (SMPSU)

IWA-250 Amplifier

The IWA-250 switch mode amplifier is a slim, powerful design in a robust 1U rack mount case. Delivering up to 250 W into 4 ohms, the IWA-250 has input signal sensing, or is triggered from an AVR or other system source.



CLG-W12

There is a subwoofer available for the Climate Garden System.
Please view Page 33 for full details.



Amplifiers



Our Installation Amplifier family offers full power automation with simple wired voltage trigger or signal sense. Superb sound and slick looks, these audio engines are ready for any installation project.

Our Connect Amplifiers offer complex DSP and IP control, all models here deliver the great sound and reliability you would expect from Monitor Audio.



Amplifier Features

- Power Switch** – Front panel mounted
- Status LED** – Indicating standby, power on or protect modes
- Signal LED's** – Indicating a signal is present at each channel independently. It will also indicate clipping
- Power Options** – Trigger input – 3 – 30 V AC or DC. A trigger output provides signal for additional amplifiers or other equipment.
- Audio** – Auto signal sensing or permanently on
- Speaker Connections** – Industry standard removable block connectors accepts up to 12 gauge (3.5 mm²) cable

Rack Mounted / Free Standing

IA150-2



'Connect' IP control	No	
Channel Number	2 (1 Stereo Pair)	
Power (W / Channel)	4 ohms	150 W
	8 ohms	100 W
	Bridge (8 ohms)	320 W (1CH)
	70V	N/A
Input Impedance	20 K ohms	
Output Impedance (Loop RCA)	600 ohms	
Input Sensitivity	100 mV / 1 W – 1000 mV – Full power	
Rack Height	1U	
Dimensions (Without feet) (H x W x D)	42.4 x 438 x 427 mm 1 ^{11/16} x 17 ^{1/4} x 16 ^{13/16} "	
Height (With feet)	52.8 mm / 2 ^{1/16} "	
Width (Including rack brackets)	482 mm / 19"	

Monitor Audio amplifiers are built to do more and use less space. Our amplifiers offer full connectivity with simple wired voltage trigger or signal sense. The IA150-2 powers a stereo pair, with rear panel-located volume adjustment for each channel. Just 42 mm high, 438 mm wide, and 427 mm deep, the handsome case houses world renowned Hypex amplifiers, selected by us to guarantee reliability and the great sound quality the world has come to expect from Monitor Audio.

IA60-12



'Connect' IP control	No	
Channel Number	12 (6 Stereo Pairs)	
Power (W / Channel)	4 ohms	60 W
	8 ohms	45 W
	Bridge (8 ohms)	100 W (6CH)
	70V	N/A
Input Impedance	20 K ohms	
Output Impedance (Loop RCA)	600 ohms	
Input Sensitivity	100 mV / 1 W – 700 mV – Full power	
Rack Height	2U	
Dimensions (Without feet) (H x W x D)	86.8 x 438 x 427 mm 3 ^{7/16} x 17 ^{1/4} x 16 ^{13/16} "	
Height (With feet)	97.2 mm / 3 ^{13/16} "	
Width (Including rack brackets)	482 mm / 19"	

The IA60-12 powers up to 12 channels (six stereo pairs) and is configurable to 1, 2, 3, 4, 5, 6, or 12 channels. Employing Hypex amplifier technology, this model assimilates our unrivalled experience of the custom installation sector to serve an audio engine ready to excel in your project.

IA150-2 / IA60-12 Additional Features

Volume Level Controls – Each channel on the amplifier has a volume adjustment on the rear panel

IA150-2 – Both Line Inputs and Loop Outputs – To connect other amplifiers/equipment

IA60-12 – Bus Inputs A/B and Loop Outputs –

Loop outputs are non buffered (maximum number of amplifiers that can be looped together will depend on the output capability of your source component)



'Connect' Amplifiers

'Connect' IP interface

IA800-2C / IA200-2C / IA150-8C

Our 'Connect' IP interface is a web application, which can be accessed by any device with a web browser connected to the same network as the 'Connect' amplifier. This will allow the installer to set features and fine tune audio performance remotely from the amplifier location. The installer can therefore be in the same room as the speakers when performing these tasks.



Works with:

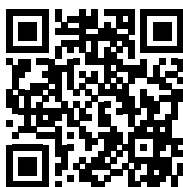

Instructional videos available, scan the QR code or visit:

vimeo.com/monitoraudio/ci-amps

IA800-2C



'Connect' IP control	Yes	
Channel Number	2 (1 Stereo Pair)	
Power (W / Channel)	4 ohms	800 W
	8 ohms	500 W
	Bridge (8 ohms)	2000 W (1CH)
	70V	800 W (2CH)
Input Impedance	20 K ohms	
Output Impedance (Loop RCA)	600 ohms	
Input Sensitivity	100 mV / 1 W – 2200 mV – Full power	
Rack Height	2U	
Dimensions (Without feet) (H x W x D)	86.8 x 438 x 427 mm 3 ⁷ / ₁₆ x 17 ¹ / ₄ x 16 ¹³ / ₁₆ "	
Height (With feet)	97.2 mm / 3 ¹³ / ₁₆ "	
Width (Including rack brackets)	482 mm / 19"	

The IA800-2C is part of our 'Connect' Amplifiers division, bringing our Connect IP interface, a web application which can be accessed by any device connected to the internet with a web browser on the same network. Fluently delivering up to 800 W per channel, this two-channel engine can directly drive 70 V line speakers without a line matching transformer.

IA200-2C



'Connect' IP control	Yes	
Channel Number	2 (1 Stereo Pair)	
Power (W / Channel)	4 ohms	200 W
	8 ohms	150 W
	Bridge (8 ohms)	470 W (1CH)
	70V	N/A
Input Impedance	20 K ohms	
Output Impedance (Loop RCA)	600 ohms	
Input Sensitivity	100 mV / 1 W – 1230 mV – Full power	
Rack Height	1U	
Dimensions (Without feet) (H x W x D)	42.4 x 438 x 427 mm 1 ¹¹ / ₁₆ x 17 ¹ / ₄ x 16 ¹³ / ₁₆ "	
Height (With feet)	52.8 mm / 2 ¹ / ₁₆ "	
Width (Including rack brackets)	482 mm / 19"	

The IA200-2C Installation Amplifier offers high power levels, supplying up to 200 W per channel at four ohms. A member of our 'Connect' Amplifiers family, it employs our Connect IP interface, a web application which can be accessed by any device connected to the internet with a web browser on the same network.

IA150-8C



'Connect' IP control	Yes	
Channel Number	8 (4 Stereo Pairs)	
Power (W / Channel)	4 ohms	150 W
	8 ohms	140 W
	Bridge (8 ohms)	300 W (4CH)
	70V	N/A
Input Impedance	20 K ohms	
Output Impedance (Loop RCA)	600 ohms	
Input Sensitivity	100 mV / 1 W – 1140 mV – Full power	
Rack Height	1U	
Dimensions (Without feet) (H x W x D)	42.4 x 438 x 427 mm 1 ¹¹ / ₁₆ x 17 ¹ / ₄ x 16 ¹³ / ₁₆ "	
Height (With feet)	52.8 mm / 2 ¹ / ₁₆ "	
Width (Including rack brackets)	482 mm / 19"	

The Monitor Audio Installation Amplifiers are configurable to 1, 2, 3, 4, 5, 6, or 12 channels. The IA150-8C enables up to eight (four stereo pairs) channels of 150 W of power at four ohms. It'll fit 1U rack height and, as a member of the Monitor Audio 'Connect' division, it employs our 'Connect' IP interface, a web application which can be accessed by any device connected to the internet with a web browser on the same network.

'Connect' Amplifiers Additional Features

Higher power levels

Volume Level Controls – Each channel on the amplifier has a volume adjustment on the front panel

'Connect' – IP control is via the RJ-45 input. IP controls power On/Off, volume, muting and input source selections for either global control or group control

IR Control – In/Out jacks. IR controls global On/Off, group volume, muting and input source selections. Connectivity can be seen with IR status light

IA800-2C – Can drive 70 V line speakers directly without a line matching transformer



Soundbars



Active Soundbar

Free Standing / On-Wall

ASB-10



Power Handling (RMS)	Bass/Mid-range: 2 x 30 W Tweeter: 2 x 20 W
Driver Size & Technology	4 x 3" C-CAM metal cone bass mid-range drivers 2 x 1 C-CAM Gold Dome tweeters 2 x ABRs (Auxiliary bass radiator) Digital wireless 2.4 GHz transmitter, Dolby Digital, Dolby Pro-Logic II and Dolby Virtual speaker Compact dimensions for easy positioning beneath the TV, on-wall or cabinet location
Dimensions (H x W x D)	100 x 904 x 95 mm / 3 ¹⁵ / ₁₆ " x 35 ⁹ / ₁₆ " x 3 ³ / ₄ "
Amplifier Category	Class D
Suitable for display sizes	All

ASB-10

The Monitor Audio ASB-10 delivers the sound quality your HD and UHD pictures deserve. Complete with optional wireless active subwoofer we've expertly engineered the ASB-10 to transform your TV experience.



ASB-10 shown above with optional [WS-10](#) wireless active subwoofer. Optional/additional [WT-1](#) transmitter and [WR-1](#) receiver wireless links, allow the flexibility of enabling the ASB-10 to wirelessly sync with an alternative subwoofer or integrate the [WS-10](#) wirelessly with a receiver/amplifier within an audio system in situ. Find out more about [WS-10](#), [WT-1](#) and [WR-1](#) at monitoraudio.com

Passive Soundbars

Free Standing / On-Wall

Add powerful audio to your TV experience. Our high-performance range of passive soundbars fits a range of screen sizes, complete with contemporary lifestyle design and first-class finish.



SB-3 shown without outer cloth

SB-2 suitable with 50" – 60" Screens



SB-3 suitable with 60" – 70" Screens



SB-4 suitable with 70"+ Screens



	SB-2	SB-3	SB-4
Sensitivity (1W@1m)	84 dB	Left and Right Channels: 84 dB Centre Channel: 87 dB	87 dB
Power Handling (RMS)	40 W	Left and Right Channels: 40 W Centre Channel: 80 W	80 W
Driver Size & Technology	3 x 4" C-CAM cone bass/mid drivers 3 x 1" C-CAM Gold Dome tweeters 3 x ABRs (Auxiliary bass radiator) Loading	4 x 4" C-CAM cone bass/mid drivers 3 x 1" C-CAM Gold Dome tweeters 4 x ABRs (Auxiliary bass radiator) Loading	6 x 4" C-CAM cone bass/mid drivers 3 x 1" C-CAM Gold Dome tweeters 4 x ABRs (Auxiliary bass radiator) Loading
Dimensions (H x W x D)	145 x 1110 x 89 mm 5 ^{11/16} x 43 ^{11/16} x 3 ^{1/2} "	145 x 1310 x 89 mm 5 ^{11/16} x 51 ^{9/16} x 3 ^{1/2} "	145 x 1562 x 88 mm 5 ^{3/4} x 61 ^{1/2} x 3 ^{1/2} "
Suitable for display sizes	50" – 60"	60" – 70"	70"+
On-Wall Bracket (optional)	BSB	BSB	BSB

SB-2

Engineered for seamless integration with 50 – 60" TVs, the SB-2 passive soundbar houses three separate driver arrays – one each for left, centre, and right channels – in a single cabinet. Just add an AV amplifier and, to further enhance audio performance in larger rooms, partner with one of our muscular subwoofers.

SB-3

Monitor Audio engineered the SB-3 passive soundbar for seamless integration with 60 – 70" TVs. At just 1310 mm wide, we've applied our speaker design know-how to create three separate driver arrays within the elegant cabinet. In larger rooms, you can add a partnering Monitor Audio subwoofer. With or without a subwoofer, the SB-3 effortlessly transforms your entertainment experience, working its wonders with gaming as well as movies and TV shows.

SB-4

The largest model in our passive soundbar range, we've designed the SB-4 to provide a visually balanced audio solution for 70" TVs and beyond. Compatible with SANUS TV mounting systems, when looking for the ideal passive soundbar for installers, we've got the answer.

SoundFrames

In-Wall / On-Wall

Ingeniously designed speakers to replicate picture frames, you can even complete the SoundFrame speakers with customised image grille designs. Both In-Wall and On-Wall options offer that elusive blend of superior sound and décor that all style-conscious home entertainment fans seek. Keyhole fixings for On-Wall and pre-fix corner brackets for the In-Wall models make the process routine.

SoundFrame 1



SoundFrame 2



SoundFrame 3



Sensitivity (1W@1m)	86 dB	86 dB	85 dB
In-Wall Cut Out Dimensions (H x W)	501 x 351 mm 19 ^{11/16} x 13 ^{3/4} "	751 x 201 mm 29 ^{1/2} x 7 ^{7/8} "	251 x 251 mm 9 ^{7/8} x 9 ^{7/8} "
In-Wall Mounting Depth	75 mm / 2 ^{15/16} "	75 mm / 2 ^{15/16} "	59.5 mm / 2 ^{5/16} "
In-Wall Overall Dimensions (H x W x D)	552 x 402 x 88.25 mm 21 ^{3/4} x 15 ^{13/16} x 3 ^{1/2} "	802.5 x 252.5 x 87.5 mm 31 ^{5/8} x 9 ^{15/16} x 3 ^{7/16} "	301.5 x 301.5 x 77.5 mm 11 ^{7/8} x 11 ^{7/8} x 3 ^{1/16} "
On-Wall Overall Dimensions (H x W x D)	540 x 390 x 87.5 mm 21 ^{1/4} x 15 ^{3/8} x 3 ^{7/16} "	790 x 240 x 87.5 mm 31 ^{1/8} x 9 ^{7/16} x 3 ^{7/16} "	289 x 289 x 77.5 mm 11 ^{3/8} x 11 ^{3/8} x 3"
Power Handling (RMS)	100 W	100 W	50 W
Impedance	8 ohms	8 ohms	8 ohms
Driver Size & Technology	6 ^{1/2} " C-CAM RST driver Pivoting IDC module (4" C-CAM RST inverted mid-range driver, 1" C-CAM Gold Dome tweeter) HF Control	6 ^{1/2} " C-CAM RST driver Pivoting IDC module (4" C-CAM RST inverted mid-range driver, 1" C-CAM Gold Dome tweeter) HF Control	4" C-CAM driver 1" C-CAM pivoting Gold Dome tweeter

SoundFrame 1

With its wonderful sound and effortlessly stylish design, the SoundFrame 1 speaker is a solution for all. Adopting the aspect of a typical portrait picture frame, the Monitor Audio SoundFrame 1 is available in both In-Wall and On-Wall formats.

SoundFrame 2

Part of the Monitor Audio SoundFrame family, the SoundFrame 2 is the longer, centre channel of the range. As pretty as a picture, you can place it horizontally or vertically, depending on the system layout. Incredibly, it is just 87 mm deep, yet houses our pivoting IDC module – 25 mm C-CAM Gold Dome tweeter, and 4" C-CAM RST inverted mid-range driver – with a 6.5" C-CAM bass driver with RST cone.

SoundFrame 3

The most compact of our super-stylish SoundFrame series, the SoundFrame 3 comes in both In-Wall and On-Wall structures. Use it on its own, or assign to it rear speaker duties as part of a SoundFrame room system. A two-way configuration, equipped with a pivoting 25 mm Gold Dome tweeter and 4" C-CAM mid-range driver, this little ported box packs a sonic and design punch.

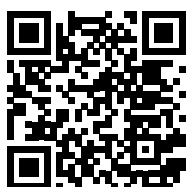

Explanation video available,
scan the QR code or visit:

vimeo.com/monitormedia/soundframe



SoundFrames



In-Wall

In-Wall fixings

Product fixed into wall using corner brackets

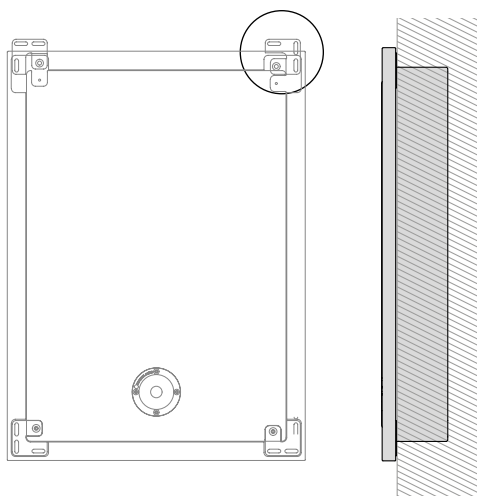

Grille removed



Vertical or horizontal orientation



On-Wall

On-Wall fixings

Product hangs on wall via keyhole fixings

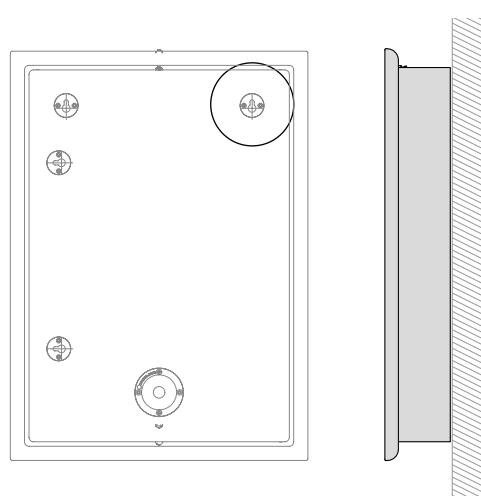

Exploded view

Frame and grille attached using pegs and sockets



Cabinet

Frame

Grille

When ordering your SoundFrame state if you require the In-Wall or On-Wall options. Order Black Gloss or White Gloss finish.



Finishes
 Black Gloss and
 White Gloss

Customise your SoundFrame Grilles

Add even more personality to our already super-stylish picture frame design speaker by specifying custom grilles, including even bespoke images provided by the customer. All options can also be created using our larger Frameless grilles where the outer frame is also removed.



Option 1:
Library Grille



Floral artwork example

Option 2:
Bespoke Grille



Bespoke image on SoundFrame 1

Options 1 & 2:
Frameless Grilles



Black Frameless grille

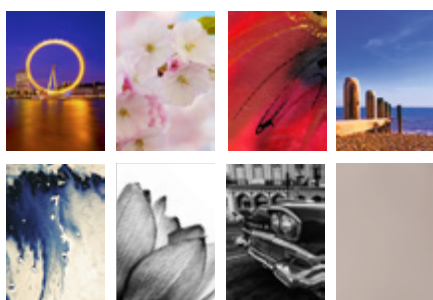

This shows a small selection of our library grilles, there is a different selection for the three sizes of SoundFrame. For an overview please scan the QR code or visit: bit.ly/soundframe-grilles



Bespoke image on SoundFrame 2

Please contact your local dealer to place an order for a bespoke grille. There are file specifications in place to achieve best results please only use high resolution images.



Library image
Frameless grille



Bespoke image
Frameless grille

The larger Frameless grilles replace both the grille and frame to give the impression of an edgeless image. Plain Black or White options available.



When ordering your customised SoundFrame grille, state which image you require, which size of SoundFrame and if you prefer the framed or frameless option.

Accessories

As any installer knows, the devil is in the detail. Our extensive Accessories offering leaves no detail untouched, covering pre-construction brackets for In-Ceiling and In-Wall applications, as well as a selection of back boxes – In-Ceiling Concrete, In-Ceiling MDF, and In-Wall Concrete. We also offer product specific back boxes, and square grilles for our numerous In-Ceiling speaker models.

Pre-Construction Brackets

Pre-Construction brackets are available for speakers as an accessory to help mark speaker placement during framing and prior to sheetrock application. The brackets will span up to 24" stud spacing. Pre-Construction brackets are not required for retrofit applications.

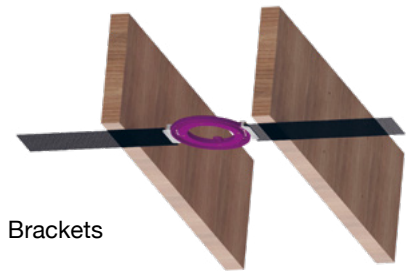

In-Ceiling Pre-Construction Brackets

CB4 	CB4	Page
	CS140	12

CB5 	CB5	Page
	CS160	12

CB6 	CB6	Page
	C165	8
	C165-T2	8
	C265	8
	C265-IDC	8
	C265-FX	8
	CS180	12
	CSS230	13
	CP-CT150	15
	AWC265	29
	AWC265-T2	29

CB8 	CB8	Page
	C180	9
	C180-T2	9
	C280	9
	C280-IDC	9
	C380-IDC	9
	C380-FX	9
	CP-CT260	15
	PRO-80	27
	AWC280	29
	AWC280-T2	29

CB10 	CB10	Page
	CP-CT380	15
	CP-CT380IDC	15
	PLIC II	25

PRO-IC65 Bracket	PRO-IC65	Page
	PRO-65	27

CB8-LV 	CB8-LV	Page
	PRO-80LV	27

CB8-LVK 	CB8-LVK	Page
	PRO-80LV	27

In-Wall Pre-Construction Brackets

WB3 	WB3	Page
	WSS130	14
	WSS230	14
	WSS430	14

WB6 	WB6	Page
	W165	10
	W265	10
	CP-WT150	16

WB8 	WB8	Page
	W180	11
	W280	11
	W280-IDC	11
	W380-IDC	11
	CP-WT260	16

WB10 	WB10	Page
	CP-WT380	16
	CP-WT380IDC	16

WB12 	WB12:	Page
	CP-IW260X	18
	CP-IW460X	18

WB4LCR 	WB4LCR	Page
	CP-WT140LCR	17
	CP-WT240LCR	17

WB5LCR 	WB5LCR	Page
	W150-LCR	10
	W250-LCR	10

On-Wall Bracket

BSB 	BSB (Soundbars)	Page
	SB-2	39
	SB-3	39
	SB-4	39

Back Boxes

In-Ceiling Concrete

CCBOX-R



Overall dimensions:
330 × 330 × 125 mm / 13 × 13 × 4^{15/16}"
Internal depth (max.): 115 mm / 4^{1/2}"
Internal volume 6.31 L

CCBOX-L



Overall dimensions:
330 × 330 × 165 mm / 13 × 13 × 6^{1/2}"
Internal depth (max.): 155 mm / 6^{1/8}"
Internal volume 8.9 L

Prior to pouring a concrete ceiling the CCBOX-R (regular) or CCBOX-L (large) allow you to create a placeholder ready for In-Ceiling speakers to be installed. They are lightweight and at the same time offer a robust stability with excellent shock absorption features. Three cut out sizes offer unlimited possibilities, with two side cut outs allow for best possible handling of electronic ductwork (20 mm + 25 mm). Better insulation with airborne and structure-borne noise compared to conventional In-Ceiling systems. Installation components provided so that all conventional speaker systems will fit perfectly.

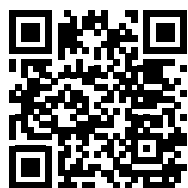

Installation Guide video available, scan the QR code or visit:

vimeo.com/monitoraudio/ccbox



In-Wall Concrete

WCBOX-L



Overall dimensions:
590 × 435 × 120 mm / 23^{1/4} × 17^{1/8} × 4^{3/4}"
Internal depth (max.):
105 mm / 4^{1/8}"
Cut out dimensions:
387 × 234 mm / 15^{1/4} × 9^{3/16}"
Internal volume 14.8 L

The WCBOX-L (large) allows you to install In-Wall speakers into concrete or brick walls. With the front and rear Fermacell boards, the WCBOX-L will seamlessly integrate into your installation workflow, enabling a quick and easy processing of the walls surface. The body material is framed by EPS to achieve low resonances and improved sound insulation features. The WCBOX-L is lightweight and at the same time offers a robust stability with excellent shock absorption features.

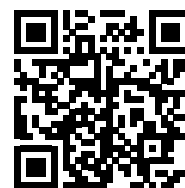

Installation Guide video available, scan the QR code or visit:

vimeo.com/monitoraudio/wcbox

In-Ceiling MDF

CMBOX-R



Overall dimensions:
300 × 350 × 160 mm / 11^{13/16} × 13^{3/4} × 6^{5/16}"
Internal volume 12.2 L

The CMBOX-R (regular) is a Back Box made of MDF, which allows you to install speakers from our Core, Slim and All Weather ranges into the ceiling. Comes with Small and Large Ring (fitted) adapters, which can also be removed.



No Ring 250 mm

Large Ring (Fitted) 218 mm

Small Ring 173 mm

Accessories Images Not To Scale

In-Ceiling Concrete

CCBOX-R	
Models	Page
C165	8
C165-T2	8
C180	9
C180-T2	9
C265	8
C280	9
CS140	12
CS160	12
CS180	12
AWC265	29
AWC265-T2	29
AWC280	29
AWC280-T2	29

CCBOX-L	
Models	Page
C265-IDC	8
C265-FX	8
CP-CT150	15
CP-CT260	15

In-Wall Concrete

WCBOX-L	
Models	Page
W180	11
W280	11
W280-IDC	11
W380-IDC	11
CP-WT260	16

In-Ceiling MDF

CMBOX-R	
No Ring	Page
C180	9
C180-T2	9
C280	9
C280-IDC	9
C380-IDC	9
C380-FX	9
AWC280	29
AWC280-T2	29
Large Ring (Fitted)	Page
C165	8
C165-T2	8
C265	8
C265-IDC	8
C265-FX	8
CS180	12
AWC265	29
AWC265-T2	29
Small Ring	Page
CS160	12

Accessories

Product Back Boxes

Platinum In-Ceiling II Back Box



Overall Dimensions (Including Brackets):
191.2 x 628.6 x 350 mm / 7^{1/2} x 24^{3/4} x 13^{3/4}"
Internal volume 24 L

PLIC-BOX II

To ensure controlled audio performance for the PLIC II, Monitor Audio has designed an optional pre-construction MDF back box with pre-determined air volume of 24 L. The rigid box is available with pre-loaded internal damping material to provide the best possible sound absorption and reduce standing waves.

[See Page 25 for more details.](#)

In-Wall Subwoofer Back Box



IWB-10 shown with installed IWS-10 and grille

Overall Dimensions (H x W x D) :
850 x 351 x 85 mm / 33^{1/2} x 13^{13/16} x 3^{11/32}"
Internal volume 16.5 L

IWB-10 (In-Wall Back Box)

Designed to provide optimum performance for IWS-10
Fits into standard 14" stud bays (16" centres)
Reduces the radiation of sound to adjacent rooms
Heavy duty MDF construction
Rugged laminated vinyl finish
Pre-wired with external high quality push type terminals
Supplied with mounting brackets for installation

[See Page 35 for more details.](#)

Square Grilles

All-round performance in a square.
Designed to suit the latest interior design trends, we offer square grilles for some of our In-Ceiling speakers.



Square grilles

Core	Page
C165	8
C165-T2	8
C265	8
C265-IDC	8
C265-FX	8
C180	9
C180-T2	9
C280	9
C280-IDC	9
C380-IDC	9
C380-FX	9
Super Slim	
CSS230	13
Controlled Performance	
CP-CT150	15
CP-CT260	15
CP-CT380	15
CP-CT380IDC	15
Platinum II	
PLIC II	25
All Weather	
AWC265	29
AWC265-T2	29
AWC280	29
AWC280-T2	29

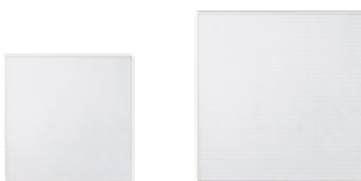

NOTE : All Slim models can be ordered as round or square grille options. [See Page 12.](#)



SPECIFICATIONS

These specifications are supplied to aid installers to select which product is the best fit for their project.

All Monitor Audio Custom Install products have CAD files available, ideal for architectural drawings.

These can be found along with individual product or range information on our website. [Click on a product to find out more.](#)

Category	Core In-Ceiling										
Application	In-Ceiling										
Model Name	C165	C165-T2	C265	C265-IDC	C265-FX	C180	C180-T2	C280	C280-IDC*	C380-IDC*	C380-FX
Page	8	8	8	8	8	9	9	9	9	9	9
Sensitivity (1W@1m)	88.5 dB	88.5 dB	88.5 dB	88.5 dB	88.5 dB	90 dB	90 dB	90 dB	90 dB	90 dB	90 dB
Cut Out Diameter	211 mm / 8 ^{1/4} "	211 mm / 8 ^{1/4} "	211 mm / 8 ^{1/4} "	211 mm / 8 ^{1/4} "	211 mm / 8 ^{1/4} "	247 mm / 9 ^{3/4} "	247 mm / 9 ^{3/4} "	247 mm / 9 ^{3/4} "	247 mm / 9 ^{3/4} "	247 mm / 9 ^{3/4} "	247 mm / 9 ^{3/4} "
Mounting Depth	114 mm / 4 ^{1/2} "	114 mm / 4 ^{1/2} "	114 mm / 4 ^{1/2} "	149 mm / 5 ^{7/8} "	149 mm / 5 ^{7/8} "	121 mm / 4 ^{3/4} "	121 mm / 4 ^{3/4} "	121 mm / 4 ^{3/4} "	156 mm / 6 ^{1/8} "	156 mm / 6 ^{1/8} "	156 mm / 6 ^{1/8} "
Overall Depth (With Grille)	118 mm / 4 ^{5/8} "	118 mm / 4 ^{5/8} "	118 mm / 4 ^{5/8} "	153 mm / 6"	153 mm / 6"	125 mm / 4 ^{15/16} "	125 mm / 4 ^{15/16} "	125 mm / 4 ^{15/16} "	160 mm / 6 ^{5/16} "	160 mm / 6 ^{5/16} "	160 mm / 6 ^{5/16} "
Overall Diameter (With Grille)	250 mm / 9 ^{13/16} "	250 mm / 9 ^{13/16} "	250 mm / 9 ^{13/16} "	250 mm / 9 ^{13/16} "	250 mm / 9 ^{13/16} "	285 mm / 11 ^{1/4} "	285 mm / 11 ^{1/4} "	285 mm / 11 ^{1/4} "	285 mm / 11 ^{1/4} "	285 mm / 11 ^{1/4} "	285mm / 11 ^{1/4} "
Power Handling (RMS)	65 W	65 W	75 W	85 W	85 W	120 W	120 W	120 W	120 W	150 W	120 W
Impedance	6 ohms	6 + 6 ohms	6 ohms	6 ohms	6 ohms	6 ohms	6 + 6 ohms	6 ohms	6 ohms	6 ohms	6 ohms
Driver Size & Technology	6 ^{1/2} " MMP II driver 1" C-CAM tweeter	6 ^{1/2} " MMP II driver 2 x 1" C-CAM tweeters	6 ^{1/2} " C-CAM driver 1" C-CAM tweeter	6 ^{1/2} " C-CAM driver 4" C-CAM RST driver 1" C-CAM tweeter	6 ^{1/2} " C-CAM driver 2 x 1" C-CAM tweeters	8" MMP II driver 1" C-CAM tweeter	8" MMP II driver 2 x 1" C-CAM tweeters	8" C-CAM driver 1" C-CAM tweeter	8" C-CAM driver 4" C-CAM RST driver 1" C-CAM tweeter	8" C-CAM RST driver 4" C-CAM RST driver 1" C-CAM tweeter	8" C-CAM RST driver 2 x 1" C-CAM tweeters
Frequency Response	60 Hz – 25 kHz	60 Hz – 25 kHz	60 Hz – 30 kHz	60 Hz – 30 kHz	60 Hz – 30 kHz	50 Hz – 25 kHz	50 Hz – 25 kHz	50 Hz – 30 kHz	50 Hz – 30 kHz	45 Hz – 30 kHz	45 Hz – 30 kHz
Maximum SPL	107.4 dBA	107.9 dBA	108 dBA	108 dBA	108 dBA	111.6 dBA	111.6 dBA	111.6 dBA	111.6 dBA	112 dBA	111.6 dBA
Recommended Amp Requirements	20 – 65 W	20 – 65 W	20 – 75 W	20 – 85 W	20 – 85 W	30 – 120 W	30 – 120 W	30 – 120 W	30 – 120 W	40 – 150 W	30 – 120 W
Optional Square Grilles	Yes	Yes	Yes	Yes	Yes	Yes	Yes	Yes	Yes	Yes	Yes
Feature	-	T2	-	IDC	FX	-	T2	-	IDC	IDC	FX
HF Level Switch (+3 dB/0 dB/-3 dB)	Yes	-	Yes	Yes	Yes	Yes	Yes	Yes	Yes	Yes	Yes
Boundary Compensation Switch	-	-	Yes	Yes	-	-	-	Yes	Yes	Yes	-
Bipole/ Dipole Switch	-	-	-	-	Yes	-	-	-	-	-	Yes Additional 12 V Trigger Switching
Construction Material	Mineral filled ABS plastic, RoHS2 Compliant	Mineral filled ABS plastic, RoHS2 Compliant	Mineral filled ABS plastic, RoHS2 Compliant	Mineral filled ABS plastic, RoHS2 Compliant	Mineral filled ABS plastic, RoHS2 Compliant	Mineral filled ABS plastic, RoHS2 Compliant	Mineral filled ABS plastic, RoHS2 Compliant	Mineral filled ABS plastic, RoHS2 Compliant	Mineral filled ABS plastic, RoHS2 Compliant	Mineral filled ABS plastic, RoHS2 Compliant	Mineral filled ABS plastic, RoHS2 Compliant
Weight	1.92 kg 4 lb 4 oz	2.08 kg 4 lb 10 oz	2.04 kg 4 lb 8 oz	2.54 kg 6 lb 10 oz	2.08 kg 4 lb 10 oz	2.72 kg 6 lb	3 kg 6 lb 10 oz	2.8 kg 6 lb 2 oz	3.42 kg 7 lb 8 oz	3.64 kg 8 lb	3.2 kg 7 lb
Pre-Construction Bracket	CB6 (Purple)	CB6 (Purple)	CB6 (Purple)	CB6 (Purple)	CB6 (Purple)	CB8 (Green)	CB8 (Green)	CB8 (Green)	CB8 (Green)	CB8 (Green)	CB8 (Green)
Back Box	COBOX-R / CMBOX-R	CCBOX-R / CMBOX-R	CCBOX-R / CMBOX-R	CCBOX-L / CMBOX-R	CCBOX-L / CMBOX-R	CCBOX-R / CMBOX-R	CCBOX-L / CMBOX-R	CCBOX-L / CMBOX-R	CMBOX-R	CMBOX-R	CMBOX-R

Category	Core In-Wall							
Application	In-Wall							
Model Name	W150-LCR	W250-LCR	W165	W265	W180	W280	W280-IDC	W380-IDC
Page	10	10	10	10	11	11	11	11
Sensitivity (1W@1m)	88 dB	88 dB	88.5 dB	88.5 dB	90 dB	90 dB	90 dB	90 dB
Cut Out Dimensions (H x W)	145 x 353 mm 5 ^{3/4} x 13 ^{7/8} "	145 x 353 mm 5 ^{3/4} x 13 ^{7/8} "	332 x 213 mm 13 ^{1/16} x 8 ^{3/8} "	332 x 213 mm 13 ^{1/16} x 8 ^{3/8} "	387 x 234 mm 15 ^{1/4} x 9 ^{3/16} "	387 x 234 mm 15 ^{1/4} x 9 ^{3/16} "	387 x 234 mm 15 ^{1/4} x 9 ^{3/16} "	387 x 234 mm 15 ^{1/4} x 9 ^{3/16} "
Mounting Depth	100.2 mm / 4"	100.2 mm / 4"	85.5 mm / 3 ^{3/8} "	85.5 mm / 3 ^{3/8} "	93 mm / 3 ^{11/16} "	93 mm / 3 ^{11/16} "	93 mm / 3 ^{11/16} "	97.5mm / 3 ^{13/16} "
Overall Depth (With Grille)	105 mm / 4 ^{1/8} "	105 mm / 4 ^{1/8} "	89.5 mm / 3 ^{1/2} "	89.5 mm / 3 ^{1/2} "	97.5 mm / 3 ^{13/16} "	97.5 mm / 3 ^{13/16} "	97.5 mm / 3 ^{13/16} "	101.5 mm / 4"
Overall Dimensions (With Grille) (H x W)	177.4 x 385.2 mm 7 x 15 ^{3/16} "	177.4 x 385.2 mm 7 x 15 ^{3/16} "	370 x 250 mm 14 ^{9/16} x 9 ^{13/16} "	370 x 250 mm 14 ^{9/16} x 9 ^{13/16} "	441 x 288 mm 17 ^{3/8} x 11 ^{5/16} "	441 x 288 mm 17 ^{3/8} x 11 ^{5/16} "	441 x 288 mm 17 ^{3/8} x 11 ^{5/16} "	441 x 288 mm 17 ^{3/8} x 11 ^{5/16} "
Power Handling (RMS)	100 W	100 W	65 W	65 W	120 W	120 W	150 W	150 W
Impedance	8 ohms	8 ohms	6 ohms	6 ohms	6 ohms	6 ohms	6 ohms	6 ohms
Driver Size & Technology	2 x 5" MMP II drivers 1" C-CAM tweeter	2 x 5" C-CAM drivers 1" C-CAM tweeter	6 ^{1/2} " MMP II driver 1" C-CAM tweeter	6 ^{1/2} " C-CAM driver 1" C-CAM tweeter	8" MMP II driver 1" C-CAM tweeter	8" C-CAM driver 1" C-CAM tweeter	8" C-CAM driver 4" C-CAM RST driver 1" C-CAM tweeter	8" C-CAM RST driver 4" C-CAM RST driver 1" C-CAM tweeter
Frequency Response	60 Hz – 30 kHz	60 Hz – 30 kHz	60 Hz – 25 kHz	55 Hz – 30 kHz	50 Hz – 25 kHz	45 Hz – 30 kHz	45 Hz – 30 kHz	45 Hz – 30 kHz
Maximum SPL	108 dBA	108 dBA	107.4 dBA	107.4 dBA	111.6 dBA	111.6 dBA	111.6 dBA	112 dBA
Recommended Amp Requirements	30 – 100 W	30 – 100 W	20 – 65 W	20 – 65 W	30 – 120 W	30 – 120 W	40 – 150 W	40 – 150 W
Feature	LCR	LCR	-	-	-	-	IDC	IDC
HF Level Switch (+3 dB/0 dB/-3 dB)	-	Yes	Yes	Yes	Yes	Yes	Yes	Yes
MF Level Switch (+3 dB/0 dB/-3 dB)	-	-	-	-	-	-	-	Yes
Boundary Compensation Switch	-	-	-	Yes	-	Yes	Yes	Yes
Construction Material	Mineral filled ABS plastic, RoHS2 Compliant	Mineral filled ABS plastic, RoHS2 Compliant	Mineral filled ABS plastic, RoHS2 Compliant	Mineral filled ABS plastic, RoHS2 Compliant	Mineral filled ABS plastic, RoHS2 Compliant	Mineral filled ABS plastic, RoHS2 Compliant	Mineral filled ABS plastic, RoHS2 Compliant	Mineral filled ABS plastic, RoHS2 Compliant
Weight	3.76 kg / 8 lb 3oz	3.80 kg / 8 lb 4 oz	2.21 kg / 4 lb 14 oz	2.26 kg / 5 lb	3.08 kg / 6 lb 12 oz	3.1 kg / 6 lb 14 oz	3.6 kg / 7 lb 14 oz	4.1 kg / 9 lb
Pre-Construction Bracket	WB5LCR (Yellow)	WB5LCR (Yellow)	WB6 (Purple)	WB6 (Purple)	WB8 (Green)	WB8 (Green)	WB8 (Green)	WB8 (Green)
Back Box	-	-	-	-	WCBOX-L	WCBOX-L	WCBOX-L	WCBOX-L

Plasterboard/Sheetrock maximum mounting thickness

This table shows the maximum mounting thickness of the plasterboard/Sheetrock required for Monitor Audio Custom Install products.

Most products unless stated below	1 ^{3/16} " / 30 mm
In-Ceiling IDC*	1 ^{15/16} " / 50 mm
Super Slim**	9/16" / 15 mm



SPECIFICATIONS

Category	Slim			Super Slim			
Application	In-Ceiling / In-Wall			In-Ceiling	In-Wall		
Model Name	CS140 Round/Square	CS160 Round/Square	CS180 Round/Square	CSS230**	WSS130**	WSS230**	WSS430**
Page	12	12	12	13	14	14	14
Sensitivity (1W@1m)	85 dB	88 dB	90 dB	86 dB	87 dB	87 dB	87 dB
Cut Out Diameter or Dimensions (H x W)	149 mm 5 ^{7/8} "	170 mm 6 ^{11/16} "	213 mm 8 ^{3/8} "	211 mm 8 ^{1/4} "	346 x 101 mm 13 ^{1/2} x 4"	346 x 101 mm 13 ^{1/2} x 4"	346 x 101 mm 13 ^{1/2} x 4"
Mounting Depth	99 mm / 3 ^{7/8} "	99 mm / 3 ^{7/8} "	99.4 mm / 3 ^{15/16} "	50 mm / 2"	50 mm / 2"	50 mm / 2"	50 mm / 2"
Overall Depth (With Grille)	103.4 mm 4 ^{1/16} "	102.8 mm 4 ^{1/16} "	103.3 mm 4 ^{1/16} "	54 mm 2 ^{1/8} "	54.25 mm 2 ^{1/8} "	54.25 mm 2 ^{1/8} "	54.25 mm 2 ^{1/8} "
Overall Diameter or Dimensions (With Grille) (H x W)	Round: 180.2 mm / 7 ^{1/8} " Square: 176.7 x 176.7 mm / 6 ^{15/16} x 6 ^{15/16} "	Round: 204.2 mm / 8 ^{1/16} " Square: 199.2 x 199.2 mm / 7 ^{13/16} x 7 ^{13/16} "	Round: 251.7 mm / 9 ^{15/16} " Square: 246.7 x 246.7 mm / 9 ^{11/16} x 9 ^{11/16} "	250 mm 9 ^{13/16} "	385 x 140.5 mm 15 x 5 ^{1/2} "	385 x 140.5 mm 15 x 5 ^{1/2} "	385 x 140.5 mm 15 x 5 ^{1/2} "
Power Handling (RMS)	50 W	70 W	120 W	40 W – Full range 60 W – Crossover set to 100 Hz @ 12 dB/Octave	60 W – Full range 100 W – Crossover set to 100 Hz @ 12 dB/Octave	60 W – Full range 100 W – Crossover set to 100 Hz @ 12 dB/Octave	75 W – Full range 120 W – Crossover set to 100 Hz @ 12dB/Octave
Impedance	6 ohms	6 ohms	6 ohms	8 ohms	8 ohms	8 ohms	8 ohms
Driver Size & Technology	4" MMP II driver 1" C-CAM tweeter	6" MMP II driver 1" C-CAM tweeter	8" MMP II driver 1" C-CAM tweeter	3 x 3" C-CAM drivers 3/4" C-CAM tweeter	3 x 3" MMP II drivers 1" C-CAM tweeter	3 x 3" C-CAM drivers 1" C-CAM tweeter	3 x 3" C-CAM drivers MPD HF transducer
Frequency Response	75 Hz – 30 kHz	60 Hz – 30 kHz	48 Hz – 30 kHz	100 Hz – 30kHz (Sealed CP) 85 Hz – 30kHz (Open back)	75 Hz – 30 kHz	75 Hz – 30 kHz	70 Hz – 50 kHz
Maximum SPL	102.8 dBA	107.2 dBA	110.6 dBA	103.8 dBA	105.6 dBA	105.6 dBA	106.5 dBA
Recommended Amp Requirements	10 – 50 W	15 – 70 W	30 – 120 W	10 – 60 W	10 – 100 W	10 – 100 W	10 – 120 W
Optional Square Grilles	Order Round or Square	Order Round or Square	Order Round or Square	Yes	-	-	-
Construction Material	Mineral filled ABS plastic, RoHS2 Compliant	Mineral filled ABS plastic, RoHS2 Compliant	Mineral filled ABS plastic, RoHS2 Compliant	Mineral filled ABS plastic, RoHS2 Compliant	Mineral filled ABS Plastic, RoHS2 Compliant	Mineral filled ABS Plastic, RoHS2 Compliant	Mineral filled ABS Plastic, RoHS2 Compliant
Weight	1.18 kg / 2 lb 10 oz	2.10 kg / 4 lb 6 oz	2.72 kg / 6 lb	2.88 kg / 6 lb 5 oz	1.4 kg / 3 lb 2 oz	1.4 kg / 3 lb 2 oz	1.1 kg / 2 lb 6 oz
Pre-Construction Bracket	CB4 (Pink)	CB5 (Blue)	CB6 (Purple)	CB6 (Purple)	WB3 (Dark blue)	WB3 (Dark blue)	WB3 (Dark blue)
Back Box	CCBOX-R	CCBOX-R / CMBOX-R	CCBOX-R / CMBOX-R	-	-	-	-

Category	Controlled Performance												
Application	In-Ceiling												In-Ceiling
Model Name	CP-CT150	CP-CT260	CP-CT380	CP-CT380 IDC	CP-WT150	CP-WT260	CP-WT380	CP-WT380 IDC	CP-WT140 LCR	CP-WT240 LCR	CP-IW260X	CP-IW460X	CPC120
Page	15	15	15	15	16	16	16	16	17	17	18 – 19	18 – 19	17
Sensitivity (1W@1m)	85 dB	88 dB	89 dB	89 dB	85 dB	88 dB	89 dB	89 dB	88 dB	88 dB	89 dB	89 dB	85 dB
Cut Out Diameter or Dimensions (H x W)	212 mm 8 ^{3/8} "	244 mm 9 ^{5/8} "	274 mm 10 ^{13/16} "	274 mm 10 ^{13/16} "	326 x 207 mm 12 ^{13/16} x 8 ^{1/8} "	381 x 228 mm 15 x 9"	438 x 269 mm 17 ^{1/4} x 10 ^{5/16} "	438 x 269 mm 17 ^{1/4} x 10 ^{5/16} "	183 x 299 mm 7 ^{3/16} x 11 ^{3/4} "	183 x 299 mm 7 ^{3/16} x 11 ^{3/4} "	880 x 230 mm 34 ^{21/32} x 9"	880 x 230 mm 34 ^{21/32} x 9"	65 mm 2 ^{1/2} "
Mounting Depth	151 mm 5 ^{15/16} "	151 mm 5 ^{15/16} "	181 mm 7 ^{1/8} "	181 mm 7 ^{1/8} "	96 mm 3 ^{3/4} "	96 mm 3 ^{3/4} "	99 mm 3 ^{7/8} "	99 mm 3 ^{7/8} "	97 mm 3 ^{13/16} "	97 mm 3 ^{13/16} "	96 mm 3 ^{3/4} "	96 mm 3 ^{3/4} "	91.5 mm 3 ^{5/8} "
Overall Depth (With Grille)	155 mm 6 ^{1/8} "	155 mm 6 ^{1/8} "	187 mm 7 ^{3/8} "	187 mm 7 ^{3/8} "	102 mm 4"	102 mm 4"	106 mm 4 ^{1/8} "	106 mm 4 ^{1/8} "	103 mm 4 ^{1/16} "	103 mm 4 ^{1/16} "	102 mm 4"	102 mm 4"	96 mm 3 ^{3/4} "
Overall Diameter or Dimensions (With Grille) (H x W)	250 mm 9 ^{13/16} "	285 mm 11 ^{1/4} "	309 mm 12 ^{3/16} "	309 mm 12 ^{3/16} "	360.5 x 242 mm 14 ^{5/16} x 9 ^{1/2} "	415 x 262.5 mm 16 ^{5/16} x 10 ^{5/16} "	472.5 x 303.5 mm 18 ^{5/8} x 11 ^{15/16} "	472.5 x 303.5 mm 18 ^{5/8} x 11 ^{15/16} "	217 x 333 mm 8 ^{5/16} x 13 ^{1/16} "	217 x 333 mm 8 ^{5/16} x 13 ^{1/16} "	907 x 257 mm 35 ^{3/4} x 10 ^{1/8} "	907 x 257 mm 35 ^{3/4} x 10 ^{1/8} "	80 mm 3 ^{1/8} "
Power Handling (RMS)	50 W	65W	120 W	120 W	50 W	65 W	120 W	120 W	100 W	100 W	150 W	150 W	20 W 50 W using crossover @ 200 Hz
Impedance	6 ohms	6 ohms	6 ohms	6 ohms	6 ohms	6 ohms	6 ohms	6 ohms	6 ohms	6 ohms	6 ohms	6 ohms	8 ohms
Driver Size & Technology	5" MMP II driver 1" C-CAM tweeter	6" C-CAM driver 1" C-CAM tweeter	8" C-CAM RST driver 1" C-CAM tweeter	8" C-CAM RST driver 4" C-CAM IDC driver 1" C-CAM tweeter	5" MMP II driver 1" C-CAM tweeter	6" C-CAM driver 1" C-CAM tweeter	8" C-CAM RST driver 1" C-CAM tweeter	8" C-CAM RST driver 4" C-CAM IDC driver 1" C-CAM tweeter	2 x 4" MMP II drivers 1" C-CAM tweeter	2 x 4" C-CAM drivers 1" C-CAM tweeter	2 x 6 ^{1/2} " C-CAM drivers 2 x 4" C-CAM drivers 1" C-CAM tweeter	2 x 6 ^{1/2} " C-CAM RST drivers 2 x 4" C-CAM RST drivers HF ribbon transducer	2" micro driver
Frequency Response	75 Hz – 25 kHz	66 Hz – 25 kHz	50 Hz – 25 kHz	50 Hz – 30 kHz	75 Hz – 25 kHz	65 Hz – 25 kHz	50 Hz – 25 kHz	50 Hz – 30 kHz	60 Hz – 25 kHz	60 Hz – 25 kHz	50 Hz – 30 kHz	50 Hz – 60 kHz	100 Hz – 20 kHz
Maximum SPL	102.8 dBA	106.9 dBA	109.6 dBA	109.6 dBA	102.8 dBA	106.9 dBA	109.6 dBA	109.6 dBA	108.8 dBA	108.8 dBA	113.8 dBA	113.8 dBA	101.9 dBA
Recommended Amp Requirements	20 – 50 W	20 – 65 W	30 – 120 W	30 – 120W	20 – 50 W	20 – 65 W	30 – 120 W	30 – 120 W	20 – 100 W	20 – 100 W	60 – 150 W	60 – 150 W	5 – 20 W 5 – 50 W using a crossover
Optional Square Grilles	Yes	Yes	Yes	Yes	-	-	-	-	-	-	-	-	-
Feature	-	-	-	IDC	-	-	-	IDC	LCR	LCR	Full Size	Full Size	Micro
HF Level Switch (+3 dB/0 dB/-3 dB)	Yes	Yes	Yes	Yes	Yes	Yes	Yes	Yes	Yes	Yes	Yes (+1/0/-1 dB)	Yes (+1/0/-1 dB)	-
MF Level Switch (+3 dB/0 dB/-3 dB)	-	-	-	Yes	-	-	-	Yes	-	-	Yes (+1/0/-1 dB)	Yes (+1/0/-1 dB)	-
Boundary Compensation Switch	-	Yes	Yes	Yes	-	Yes	Yes	Yes	-	Yes	Yes	Yes	-
Construction Material	Mineral filled ABS plastic, RoHS2 Compliant	Mineral filled ABS plastic, RoHS2 Compliant	Mineral filled ABS plastic, RoHS2 Compliant	Mineral filled ABS plastic, RoHS2 Compliant	Mineral filled ABS plastic, RoHS2 Compliant	Mineral filled ABS plastic, RoHS2 Compliant	Mineral Filled ABS plastic / Die-Cast Aluminium Baffle, RoHS2 Compliant	Mineral Filled ABS plastic / Die-Cast Aluminium Baffle, RoHS2 Compliant	Mineral filled ABS plastic, RoHS2 Compliant	Mineral filled ABS plastic, RoHS2 Compliant	Mineral filled ABS plastic, RoHS2 Compliant	Cast Polymer / Die-Cast Aluminium Baffle, RoHS2 Compliant	Steel Bezel / Aluminium Enclosure
Weight	2.14 kg 4 lb 12 oz	2 kg 6 lb 2 oz	3.74 kg 8 lb 4 oz	4.3 kg 9 lb 8 oz	2.65 kg 5 lb 14 oz	3.31 kg 7 lb 4 oz	4.95 kg 10 lb 14 oz	5.62 kg 12 lb 6 oz	2.5 kg 5 lb 8 oz	2.5 kg 5 lb 8 oz	11.98 kg 26 lb 6 oz	12.98 kg 28 lb 6 oz	0.19 kg 7 oz
Pre-Construction Bracket	CB6 (Purple)	CB8 (Green)	CB10 (Light brown)	CB10 (Light brown)	WB6 (Purple)	WB8 (Green)	WB10 (Light brown)	WB10 (Light brown)	WB4LCR (Dark brown)	WB4LCR (Dark brown)	WB12 (Green)	WB12 (Green)	-
Back Box	CCBOX-L	CCBOX-L	-	-	-	WCBOX-L	-	-	-	-	-	-	-



SPECIFICATIONS

Category	Flush Fit	Invisible	PLATINUM II		Pro		
Application	In-Ceiling	In-Wall	In-Ceiling	In-Wall	In-Ceiling		
Model Name	CF230	IV140	PLIC II	Platinum In-Wall II	PRO-65	PRO-80	PRO-80LV
Page	20 – 21	22 – 23	25	26	27	27	27
Sensitivity (1W@1m)	82.5 dB	82 dB (when installed as directed)	90 dB	90 dB	86 dB	87 dB	87 dB
Cut Out Diameter or Dimensions (H x W)	Flush Fit 120 mm / 4 ^{3/4"} Retrofit 90 mm / 3 ^{9/16"}	591 x 350.5 mm 23 ^{1/4"} x 13 ^{13/16"}	273 mm 10 ^{3/4"}	1179 x 302 mm 46 ^{7/16"} x 11 ^{7/8"}	205 mm 8 ^{1/16"}	248 mm 9 ^{3/4"}	266 mm 10 ^{1/2"}
Mounting Depth	83.5 mm / 3 ^{5/16"}	83.5 mm / 3 ^{13/16"}	185 mm / 7 ^{5/16"}	97.5 mm / 3 ^{14/16"}	87.7 mm / 3 ^{7/16"}	98.1 mm / 3 ^{7/8"}	101.4 mm / 4"
Overall Depth (With Grille)	83.62 mm / 3 ^{5/16"}	95.5 mm / 3 ^{3/4"}	191.5 mm / 7 ^{1/2"}	105.5 mm / 4 ^{1/16"}	92.7 mm / 3 ^{11/16"}	103 mm / 4 ^{1/16"}	114 mm / 4 ^{5/16"}
Overall Diameter or Dimensions (With Grille) (H x W)	112 mm 4 ^{7/16"}	642 x 401.5 mm 25 ^{1/4"} x 15 ^{13/16"}	309 mm 12 ^{3/16"}	1207 x 332 mm 47 ^{9/16"} x 13 ^{1/16"}	232.5 mm 9 ^{5/16"}	273 mm 10 ^{3/4"}	294 mm 11 ^{9/16"}
Power Handling (RMS)	30 W – Full range – IEC268-5 rating 100 W – Music program (Using High Pass crossover filter @120 Hz)	50 W – Full range – IEC268-5 rating 100 W – Music program (Using Minimum 80 Hz High Pass filter)	150 W	200 W	30 W	40 W	40 W
Impedance	8 ohms	8 ohms	4 ohms Nominal (3.1 ohms minimum @ 1.1 kHz)	4 ohms (3.7 ohms min. @ 2.8 kHz)	8 ohms	8 ohms	16 ohms 70 V (4.8, 16, 32, 64 W) / 100 V (8, 16, 32, 64 W) power selection
Driver Size & Technology	3 ^{1/2"} Bass/mid-range C-CAM driver 3 ^{1/4"} C-CAM Gold Dome tweeter	1 x LF transducer 2 x HF transducers	8" RDT II bass driver 2 x 2" C-CAM mid-range drivers MPD HF transducer	2 x 6 ^{1/2"} RDT II drivers 4" RDT II driver MPD HF transducer	6 ^{1/2"} MMP II driver 1" fabric soft dome tweeter	8" MMP II driver 1" fabric soft dome tweeter	8" MMP II driver 1" C-CAM tweeter
Frequency Response	100 Hz – 25 kHz	75 Hz – 18 kHz (CP sealed) 55 Hz – 18 kHz (Open back)	45 Hz – 60 kHz	52 Hz – 100 kHz	75 Hz – 20 kHz	60 Hz – 20 kHz	65 Hz – 25 kHz
Maximum SPL	98 dBA (Each – Full range) 103.3 dBA (Each – Using crossover)	102.8 dBA	112 dBA	117 dBA (pair)	101.5 dBA	103.8 dBA	103.8 dBA
Recommended Amp Requirements	10 – 30 W (Full range) 10 – 100 W (Using High Pass crossover filter @120 Hz)	20 – 50 W (Full range) 20 – 100 W (Using Minimum 80 Hz High Pass filter)	50 – 150 W	100 – 200 W	10 – 30 W	10 – 40 W	10 – 40 W
Optional Square Grilles	-	-	Yes	-	-	-	-
Feature	-	-	-	-	-	-	LINE VOLTAGE
HF Level Switch (+1dB/0dB/-1dB)	-	-	Yes	Yes	-	-	-
MF Level Switch (+1dB/0dB/-1dB)	-	-	Yes	Yes	-	-	-
Construction Material	Mineral filled ABS plastic, RoHS2 Compliant	MDF	Mineral filled ABS plastic, RoHS2 Compliant, Die cast Aluminium	25 mm MDF with steel back	Mineral filled ABS plastic, RoHS2 Compliant	Mineral filled ABS plastic, RoHS2 Compliant	Mineral filled ABS plastic, RoHS2 Compliant / Steel rear enclosure
Weight	0.44 kg / 1 lb	9 kg / 20 lb	5.3 kg / 11 lb 10 oz	27 kg / 59 lb 8 oz	1.86 kg / 4 lb 2 oz	2.42 kg / 5 lb 5 oz	4.85 kg / 10 lb 11 oz
Pre-Construction Bracket	Flush Fit – CFB3-R (round) / CFB3-SQ (square). Pre-construction bracket included in above kits Retrofit – CFB3-KIT	WBIV140	CB10 (Light brown)	-	PRO-IC65 Construction Bracket	CB8 (Green)	CB8-LV CB8-LVK
Back Box	-	-	PLIC-BOX II or a bespoke sealed enclosure of 24 L	-	-	-	-

Category	All Weather				Vecta	Climate				Climate Garden System		
Application	In-Ceiling				Wall / Corner Mounted	Wall Mounted				In-Ground / Mounted		Subwoofer
Model Name	AWC265	AWC265-T2	AWC280	AWC280-T2	V240	Climate 50	Climate 60	Climate 60-T2	Climate 80	CLG140	CLG160	CLG-W12
Page	29	29	29	29	30 – 31	32	32	32	32	33	33	33
Sensitivity (1W@1m)	88 dB	88 dB (both channels driven)	89 dB	89 dB (both channels driven)	88 dB	87 dB	88 dB	88 dB	89.5 dB	88 dB	89 dB	87 dB
Cut Out Diameter or Dimensions (H x W)	211 mm 8 ^{1/4"}	211 mm 8 ^{1/4"}	247 mm 9 ^{3/4"}	247 mm 9 ^{3/4"}	-	-	-	-	-	-	-	-
Mounting Depth	88.5 mm / 3 ^{1/2"}	88.5 mm / 3 ^{1/2"}	97.6 mm / 3 ^{7/8"}	97.6 mm / 3 ^{7/8"}	-	-	-	-	-	-	-	-
Overall Depth (With Grille)	93.5 mm 3 ^{1/2"}	93.5 mm 3 ^{1/2"}	102.5 mm 4 ^{1/32"}	102.5 mm 4 ^{1/32"}	150 mm 5 ^{7/8"}	160 mm 6 ^{3/16"}	180 mm 7 ^{1/16"}	180 mm 7 ^{1/16"}	221.5 mm 8 ^{12/16"}	-	-	-
Overall Depth (With Bracket)	-	-	-	-	175.4 mm 6 ^{7/8"}	210.4 mm 8 ^{5/16"}	235.4 mm 9 ^{5/16"}	235.4 mm 9 ^{5/16"}	273 mm 10 ^{3/4"}	-	-	-
Overall Diameter or Dimensions (With Grille) (H x W)	251.7 mm 9 ^{13/16"}	251.7 mm 9 ^{13/16"}	285 mm 11 ^{1/4"}	285 mm 11 ^{1/4"}	Excluding Mounts 335.9 x 243.2 mm 13 ^{1/4"} x 9 ^{9/16"}	285 x 172.5 mm 11 ^{1/4"} x 6 ^{13/16"}	325 x 185 mm 12 ^{13/16"} x 7 ^{5/16"}	325 x 185 mm 12 ^{13/16"} x 7 ^{5/16"}	405 x 230 mm 15 ^{15/16"} x 9 ^{1/16"}	Excluding Mount/Spike 190 x 175 mm 7 ^{1/2"} x 8 ^{1/16"}	Excluding Mount/Spike 190 x 220 mm 7 ^{1/2"} x 8 ^{1/16"}	750 x 380 x 505.5 mm 29 ^{1/2"} x 14 ^{15/16"} x 19 ^{7/8"}
Power Handling (RMS)	60 W	60 W	100 W	2 x 50 W	100 W	80 W	100 W	2 x 50 W	120 W	40 W (Crossover set to minimum 100 Hz @ 12 dB/Octave)	60 W (Crossover set to minimum 100 Hz @ 12 dB/Octave)	250 W
Impedance	8 ohms 4.4 ohms @ 190 Hz	8 + 8 ohms 4.5 ohms @ 185 Hz	8 ohms 4.5 ohms @ 185 Hz	8 + 8 ohms 4.5 ohms @ 185 Hz	4 ohms	8 ohms	8 ohms	8 + 8 ohms	8 ohms	70/100 V line level	70/100 V line level	4 ohms or 70/100 V line level (cable select)
Driver Size & Technology	6 ^{1/2"} C-CAM driver 1" C-CAM tweeter	6 ^{1/2"} C-CAM driver 2 x 1" C-CAM tweeters	8" C-CAM driver 1" C-CAM tweeter	8" C-CAM driver 2 x 1" C-CAM tweeters	2 x 4" C-CAM drivers 1" C-CAM tweeter	5 ^{1/2"} C-CAM driver 1" C-CAM tweeter ABR	6 ^{1/2"} C-CAM driver 1" C-CAM tweeter ABR	6 ^{1/2"} C-CAM driver 2 x 1" C-CAM tweeters ABR	8" C-CAM driver 1" C-CAM tweeter ABR	4" MMP II driver 1" C-CAM tweeter	6" MMP II driver 1" C-CAM tweeter	12" C-CAM bass driver
Frequency Response	60 Hz – 30 kHz	60 Hz – 30 kHz	50 Hz – 30 kHz	50 Hz – 30 kHz	70 Hz – 25 kHz	75 Hz – 30 kHz	63 Hz – 30 kHz	63 Hz – 30 kHz	50 Hz – 30 kHz	100 Hz – 30 kHz	80 Hz – 30 kHz	30 Hz – 100 Hz
Maximum SPL	105.8 dBA	105.8 dBA	109 dBA	109 dBA	108 dBA (each)	106.8 dBA	108.8 dBA	108.8 dBA	111.1 dBA	104 dBA	107 dBA	110 dBA
Recommended Amp Requirements	20 – 60 W	20 – 60 W	20 – 100 W	20 – 100 W	25 – 100 W	10 – 80 W	15 – 100 W	15 – 100 W	20 – 120 W	10 – 40 W per speaker	10 – 60 W per speaker	100 – 250 W
Optional Square Grilles	Yes	Yes	Yes	Yes	-	-	-	-	-	-	-	-
Feature	-	T2	-	T2	-	-	-	-	T2	-	-	-
HF Level Switch (+3 dB/0 dB/-3 dB)	Yes	Yes	Yes	Yes	-	-	-	-	-	-	-	-
Construction Material	Mineral Filled PC-ABS Polymer (UL V0 Fire Retardant, RoHS2 Compliant) SS430 Stainless Steel / Samarium Cobalt	Mineral Filled PC-ABS Polymer (UL V0 Fire Retardant, RoHS2 Compliant) SS430 Stainless Steel / Samarium Cobalt	Mineral Filled PC-ABS Polymer (UL V0 Fire Retardant, RoHS2 Compliant) SS430 Stainless Steel / Samarium Cobalt	Mineral Filled PC-ABS Polymer (UL V0 Fire Retardant, RoHS2 Compliant) SS430 Stainless Steel / Samarium Cobalt	Mineral filled ABS plastic, RoHS2 Compliant	High-density polypropylene enclosure / Aluminium grille	High-density polypropylene enclosure / Aluminium grille	High-density polypropylene enclosure / Aluminium grille	High-density polypropylene enclosure / Aluminium grille	Rigid, high impact cast polymer cabinet for long life and durability	Rigid, high impact cast polymer cabinet for long life and durability	High impact moulded cabinet – robust and waterproof
Weight	2.14 kg 4 lb 12 oz	2.14 kg 4 lb 12 oz	2.8 kg 6 lb 2 oz	2.8 kg 6 lb 2 oz	2.55 kg 5 lb 10 oz	3.66 kg 8 lb 1 oz	4.62 kg 10 lb 3 oz	5.02 kg 11 lb 1 oz	6.53 kg 14 lb 6 oz	2.08 kg 4 lb 10 oz	2.76 kg 6 lb 2 oz	19.5 kg 42 lb 14 oz
Operating Temperature Range	-34° to 79° C -29° to 174° F	-34° to 79° C -29° to 174° F	-34° to 79° C -29° to 174° F	-34° to 79° C -29° to 174° F	-25° to 65° C -13° to 149° F	-25° to 65° C -13° to 149° F	-25° to 65° C -13° to 149° F	-25° to 65° C -13° to 149° F	-25° to 65° C -13° to 149° F	-20° to 70° C -4° to 158° F	-20° to 70° C -4° to 158° F	-
IP Ratings	IP55	IP55	IP55	IP55	IP55	IP55	IP55	IP55	IP55	IP55	IP55	IP54
Pre-Construction Bracket / Mount	CB6 (Purple)	CB6 (Purple)	CB8 (Green)	CB8 (Green)	V-Mount / V-Corner	-	-	-	-	CLG-Mount / CLG-Spike R	CLG-Mount / CLG-Spike R	-
Back Box	CCBOX-R / CMBOX-R	CCBOX-R / CMBOX-R	CCBOX-R / CMBOX-R	CCBOX-R / CMBOX-R	-	-	-	-	-	-	-	-



Category	Custom Subwoofers				
Application	Free Standing		In-Ceiling	In-Wall	Rack Mounted / Free Standing
Model Name	CW8		ICS-8	IWS-10	IWA-250 Amplifier
Page	34		34	35	35
Sensitivity (1W@1m)	-		85 dB	86 dB	-
Cut Out Diameter or Dimensions (H x W)	-		120 mm 4 ^{3/4} "	280 x 280 mm 11 x 11"	-
Mounting Depth	-		-	90 mm / 3 ^{1/2} "	-
Overall Dimensions (With Grille) (H x W x D)	270 x 260 x 276 mm 10 ^{5/8} x 10 ^{1/4} x 10 ^{7/8} "		235 x 280 x 396 mm 9 ^{1/4} x 11 x 15 ^{5/16} "	314.21 x 314.21 x 100.78 mm 12 ^{3/8} x 12 ^{3/8} x 3 ^{15/16} "	43.7 x 43.2 x 26.3 mm 1 ^{3/4} x 1.7 x 1 ^{3/8} "
Power Handling (RMS)	-		150 W – Full range – IEC268-5 rating	150 W	-
Impedance	-		8 ohms	8 ohms	-
Driver Size & Technology	8" C-CAM driver 2 x 8" ABRs		8" C-CAM driver	10" C-CAM RDT driver	-
Frequency Response	-		40 Hz – 120 Hz	28 Hz – 120 Hz	25 Hz – 120 Hz
Maximum SPL	105.8 dBA		107 dB	Single unit 109.8 dB / Pair 115.8 dB	-
Amplifier Power Output	350 W RMS @ < 1% THD+N		400 W RMS @ < 1% THD+N	-	250 W @ < 1% THD+N
Amplifier Classification	Class D amplifier with switch mode power supply (SMPSU)		Class D amplifier with switch mode power supply (SMPSU)	-	Class D amplifier with switch mode power supply (SMPSU)
Construction Material	18 mm MDF cabinet		18 mm MDF cabinet	Mineral Filled ABS Plastic (RoHS Compliant)	3 mm thick fabricated steel case, moulded ABS front trim panel
Weight	9.52 kg / 21 lb		12.64 kg / 27 lb 12 oz	10.2 kg / 22 lb 8 oz	3.8 kg / 8 lb 6 oz
Pre-Construction Bracket	-		CFB3-R (round) / CFB3-SQ (square). Pre-construction bracket included in above kits	-	-
Back Box	-		-	IWB-10 (In-Wall Back Box)	-

Category	Amplifiers					
Application	Rack Mounted / Free Standing					
Model Name	IA150-2	IA60-12	IA800-2C	IA200-2C	IA150-8C	
Page	36	36	37	37	37	
'Connect' IP control	-					
Channel Number	2 (1 Stereo Pair)		12 (6 Stereo Pairs)	2 (1 Stereo Pair)	8 (4 Stereo Pairs)	
Power (W / Channel)	4 ohms 8 ohms Bridge (8 ohms) 70V	150 W 100 W 320 W (1CH)	60 W 45W 100 W (6CH)	800 W 500 W 2000 W (1CH) 800 W (2CH)	200 W 150 W 470 W (1CH)	150 W 140 W 300 W (4CH)
Input Impedance	20 K ohms		20 K ohms	20 K ohms	20 K ohms	20 K ohms
Output Impedance (Loop RCA)	600 ohms		600 ohms	600 ohms	600 ohms	600 ohms
Input Sensitivity	100 mV / 1 W – 1000 mV – Full power		100 mV / 1 W – 700 mV – Full power	100 mV / 1 W – 2200 mV – Full power	100 mV / 1 W – 1230 mV – Full power	100 mV / 1 W – 1140 mV – Full power
Maximum Input Voltage (RMS)	2.9 V		2.9 V	2.9 V	2.9 V	2.9 V
Signal to noise (SN:R)	-100 dB (20 Hz – 20 kHz)		-100 dB (20 Hz – 20 kHz)	-100 dB (20 Hz – 20 kHz)	-100 dB (20 Hz – 20 kHz)	-100 dB (20 Hz – 20 kHz)
Frequency Response (-3dB)	5 Hz – 50 kHz		5 Hz – 50 kHz	5 Hz – 50 kHz	5 Hz – 50 kHz	5 Hz – 50 kHz
Total Harmonic Distortion THD + N@1 KHz (@1W)	0.03% @ 1 W		0.03% @ 1 W	0.03% @ 1 W	0.03% @ 1 W	0.03% @ 1 W
Rack Height	1U		2U	2U	1U	1U
Dimensions (Without feet) (H x W x D)	42.4 x 438 x 427 mm 1 ^{11/16} x 17 ^{1/4} x 16 ^{13/16} "		86.8 x 438 x 427 mm 3 ^{7/16} x 17 ^{1/4} x 16 ^{13/16} "	86.8 x 438 x 427 mm 3 ^{7/16} x 17 ^{1/4} x 16 ^{13/16} "	42.4 x 438 x 427 mm 1 ^{11/16} x 17 ^{1/4} x 16 ^{13/16} "	42.4 x 438 x 427 mm 1 ^{11/16} x 17 ^{1/4} x 16 ^{13/16} "
Height (With feet)	52.8 mm / 2 ^{1/8} "		97.2 mm / 3 ^{13/16} "	97.2 mm / 3 ^{13/16} "	52.8 mm / 2 ^{1/8} "	52.8 mm / 2 ^{1/8} "
Width (Including rack brackets)	482 mm / 19"		482 mm / 19"	482 mm / 19"	482 mm / 19"	482 mm / 19"
Weight	5.29 kg / 11 lb 10 oz		7.34 kg / 16 lb 5 oz	9.2 kg / 20 lb 4 oz	5.3 kg / 11 lb 10 oz	7.45 kg / 16 lb 6 oz
IP Communication	-		-	TCP/IP (RJ-45 10/100 Base T)	TCP/IP (RJ-45 10/100 Base T)	TCP/IP (RJ-45 10/100 Base T)
Mains Operating Voltage	100 – 120 V @ 60 Hz, 220 – 240 V @ 50 Hz		100 – 120 V @ 60 Hz, 220 – 240 V @ 50 Hz	100 – 120 V @ 60 Hz, 220 – 240 V @ 50 Hz	100 – 120 V @ 60 Hz, 220 – 240 V @ 50 Hz	100 – 120 V @ 60 Hz, 220 – 240 V @ 50 Hz
Fuse Rating	5 A (T5AL – 250VAC)		10 A (T10AL – 250VAC)	100-120VAC: T15AL/250V AC 220-240VAC: T10AL/250V AC	5 A (T5AL – 250VAC)	10 A (T10AL – 250VAC)
Standby power consumption	<0.5 W (green mode)		<0.5 W (green mode)	<0.5 W (green mode)	<0.5 W (green mode)	<0.5 W (green mode)
Networked standby power consumption	-		-	<2 W	<2 W	<2 W

Category	Soundbars				SoundFrames					
Application	Active	Passive			In-Wall			On-Wall		
Model Name	ASB-10	SB-2	SB-3	SB-4	SoundFrame 1	SoundFrame 2	SoundFrame 3	SoundFrame 1	SoundFrame 2	SoundFrame 3
Page	38	39	39	39	40	40	40	40	40	40
Sensitivity (1W@1m)	-	84 dB	Left and Right Channels: 84 dB Centre Channel: 87 dB	87 dB	86 dB	86 dB	85dB	86 dB	86 dB	85 dB
Cut Out Dimensions (H x W)	-	-	-	-	501 x 351mm 19 ^{11/16} x 13 ^{3/4} "	751 x 201 mm 29 ^{1/2} x 7 ^{7/8} "	251 x 251 mm 9 ^{7/8} x 9 ^{7/8} "	-	-	-
Mounting Depth	-	-	-	-	75 mm / 2 ^{15/16} "	75 mm / 2 ^{15/16} "	59.5 mm / 2 ^{3/8} "	-	-	-
Overall Depth (With Grille)	95 mm 3 ^{3/4} "	89 mm 3 ^{1/2} "	89 mm 3 ^{1/2} "	88 mm 3 ^{1/2} "	88.25 mm 3 ^{1/2} "	87.5 mm 3 ^{1/2} "	77.5 mm 3"	87.5mm 3 ^{1/2} "	87.5mm 3 ^{1/2} "	77.5 mm 3"
Overall Dimensions (With Grille) (H x W)	100 x 904 mm 3 ^{15/16} x 35 ^{9/16} "	145 x 1110 mm 5 ^{11/16} x 43 ^{11/16} "	145 x 1310 mm 5 ^{11/16} x 51 ^{11/16} "	145 x 1562 mm 5 ^{3/4} x 61 ^{1/2} "	552 x 402 mm 21 ^{3/4} x 15 ^{13/16} "	802.5 x 252.5 mm 31 ^{5/8} x 9 ^{15/16} "	301.5 x 301.5 mm 11 ^{7/8} x 11 ^{7/8} "	540 x 390 mm 21 ^{1/8} x 15 ^{3/8} "	790 x 240 mm 31 ^{1/8} x 9 ^{7/16} "	289 x 289 mm 11 ^{3/8} x 11 ^{3/8} "
Power Handling (RMS)	Bass/Mid-range: 2 x 30 W Tweeter: 2 x 20 W	40 W	Left and Right Channels: 40 W Centre Channel: 80 W	80 W	100 W	100 W	50 W	100 W	100 W	50 W
Impedance	-	8 ohms	8 ohms	8 ohms	8 ohms	8 ohms	8 ohms	8 ohms	8 ohms	8 ohms
Driver Size & Technology	4 x 3" C-CAM bass/mid drivers 2 x 1" C-CAM tweeters 2 x ABRs	3 x 4" C-CAM bass/mid drivers 3 x 1" C-CAM tweeters 3 x ABRs	4 x 4" C-CAM bass/mid drivers 3 x 1" C-CAM tweeters 4 x ABRs	6 x 4" C-CAM bass/mid drivers 3 x 1" C-CAM tweeters 4 x ABRs	6 ^{1/2} " C-CAM RST driver 4" C-CAM IDC driver 1" C-CAM tweeter	6 ^{1/2} " C-CAM RST driver 4" C-CAM IDC driver 1" C-CAM tweeter	4" MMP II driver 1" C-CAM tweeter	6 ^{1/2} " C-CAM RST driver 4" C-CAM IDC driver 1" C-CAM tweeter	6 ^{1/2} " C-CAM RST driver 4" C-CAM IDC driver 1" C-CAM tweeter	4" MMP II driver 1" C-CAM tweeter
Frequency Response	65 Hz – 20 kHz	90 Hz – 30 kHz	80 Hz – 30 kHz	70 Hz – 30 kHz	55 Hz – 35 kHz	55 Hz – 35 kHz	75 Hz – 35 kHz	55 Hz – 35 kHz	55 Hz – 35 kHz	75 Hz – 35 kHz
Maximum SPL	105 dBA (@1 m)	104 dBA (108.8 dBA all channels driven)	104 dBA (108.8 dBA all channels driven)	104 dBA (108.8 dBA all channels driven)	106 dBA	106 dBA	102.5 dBA	106 dBA	106 dBA	102.5 dBA
Recommended Amp Requirements	Class D	30 – 100 W	30 – 100 W	30 – 100 W	20 – 100 W	20 – 100 W	20 – 50 W	20 – 100 W	20 – 100 W	20 – 50 W
Construction Material	Moulded polymer cabinet	MDF	MDF	MDF	MDF	MDF	MDF	MDF	MDF	MDF
Weight	11 lb 5 kg	16 lb 12 oz 7.64 kg	20 lb 9.1 kg	26 lb 7 oz 12 kg	16 lb 10 oz 7.53 kg	16 lb 7.26 kg	6 lb 10 oz 3 kg	16 lb 6 oz 7.44 kg	15 lb 9 oz 7.06 kg	6 lb 2.76 kg
Suitable for display sizes	All	50" – 60"	60"+	70"+	-	-	-	-	-	-
On-Wall Bracket	-	BSB	BSB	BSB	-	-	-	-	-	-

Category	Accessories (Back Boxes)					
Model Name	CCBOX-R	CCBOX-L	WCBOX-L	CMBOX-R	PLIC-BOX II	IWB-10
Page	44	44	44	44	45 (25)	45 (35)
Overall Dimensions (H x W x D)	330 x 330 x 125 mm 13 x 13 x 4 ^{15/16} "	330 x 330 x 165 mm 13 x 13 x 6 ^{1/2} "	590 x 435 x 120 mm 23 ^{1/2} x 17 ^{1/8} x 4 ^{3/4} "	300 x 350 x 160 mm 11 ^{13/16} x 13 ^{3/4} x 6 ^{5/16} "	191.2 x 628.6 x 350 mm 7 ^{1/2} x 24 ^{3/4} x 13 ^{3/4} " (Inc. Brackets)	850 x 351 x 85 mm 33 ^{1/2} x 13 ^{13/16} x 3 ^{11/32} "
Internal Volume	6.31 L	8.9 L	14.8 L	12.2 L	24 L	16.5 L

HOME THEATRE SYSTEMS

In-Ceiling 5.1 Home Theatre

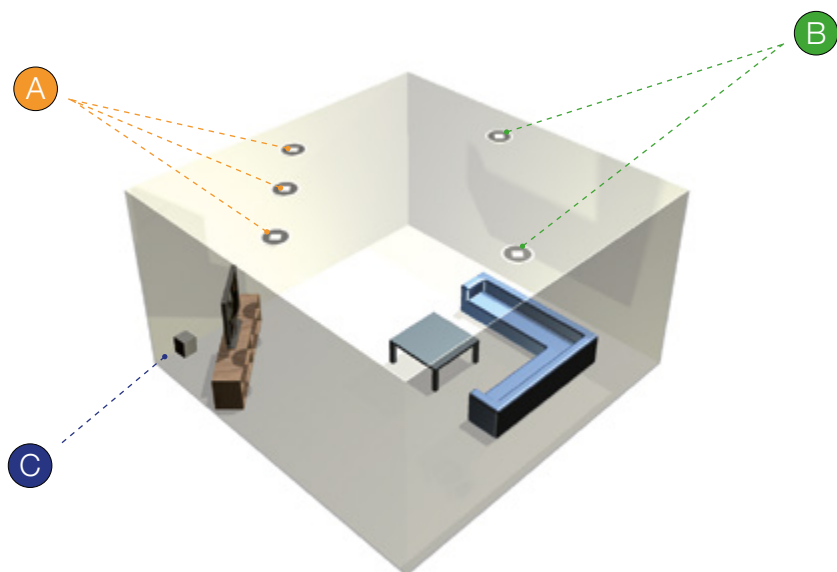

Use our Custom Install speakers in a Home Theatre system and you can create amazing systems, including 5.1, 7.1 and Dolby Atmos set-ups. Use either In-Ceiling or In-Wall, or a combination of both, and model your chosen Monitor Audio speakers in The Cinema Designer (TCD), the double CEDIA Award-winning home theatre design software. We've partnered with TCD, so you'll swiftly spot our products in the design tool's database, enabling you to create a 3D CAD drawing for any room in under 30 seconds.

All our Custom Install products can be used in conjunction with our traditional speaker ranges. To find out more about our speaker ranges please visit monitoraudio.com

In-Wall 7.1 Home Theatre

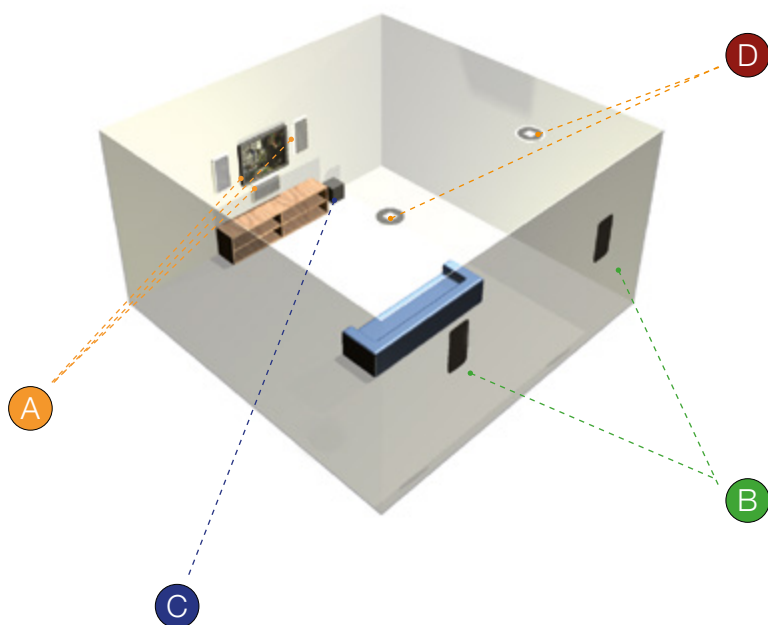

Platinum II



Silver 6G

- A Front Left-Centre-Right main loudspeakers
- B Rear Left-Right surround loudspeakers
- C Add your choice of Monitor Audio subwoofer to complete the theatre
- D You can use In-Wall front IDC loudspeakers with In-Ceiling Left-Right surrounds if desired

Find out more about Monitor Audio **Custom Install**



Visit

monitoraudio.com for product information, to find your local dealer and to sign up for our newsletter.



Download

our **Custom Install INSIDER** magazine from our website or pick one up at your local dealer.



Share

your custom installation with us on [Facebook](#), [Twitter](#) and [Instagram](#) for a chance to be in our next issue of INSIDER magazine
[@monitoraudio](#) [#monitoraudio](#)





Monitor Audio Ltd
24 Brook Road, Rayleigh,
Essex, SS6 7XJ England
T. + 44 (0)1268 740580
F. + 44 (0)1268 740589
E. info@monitoraudio.com
monitoraudio.com