

CUT STABILIZER RIBS FROM 3/32" SHEET BALS

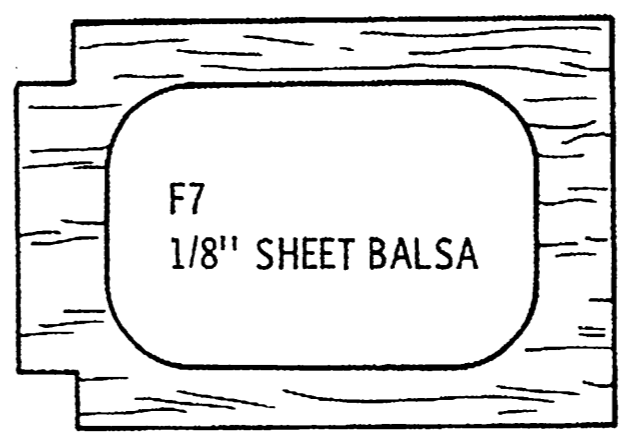
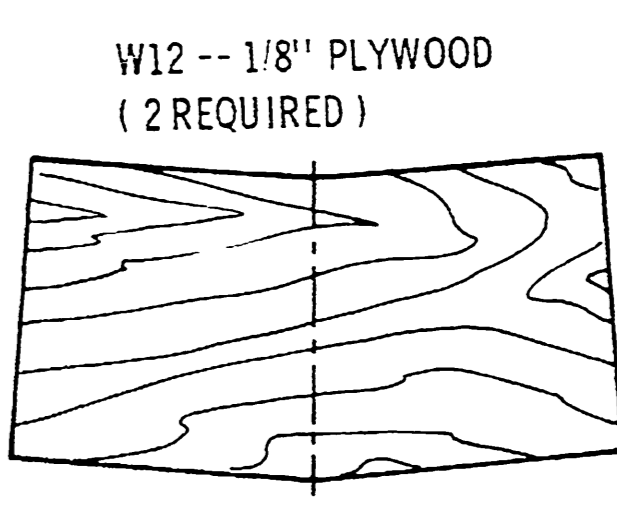
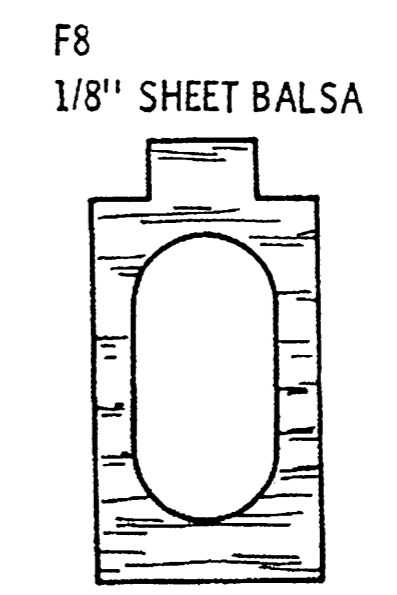
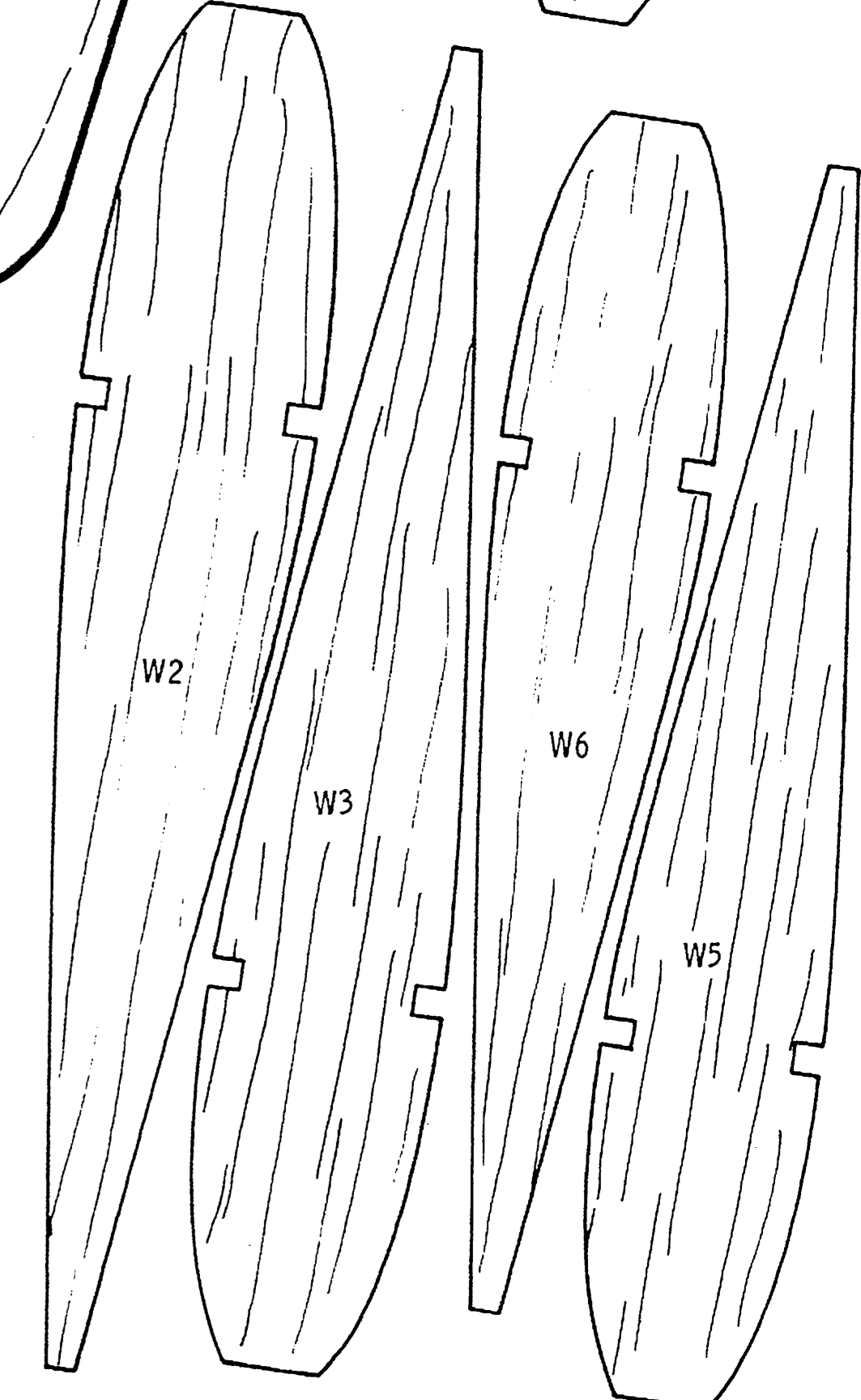
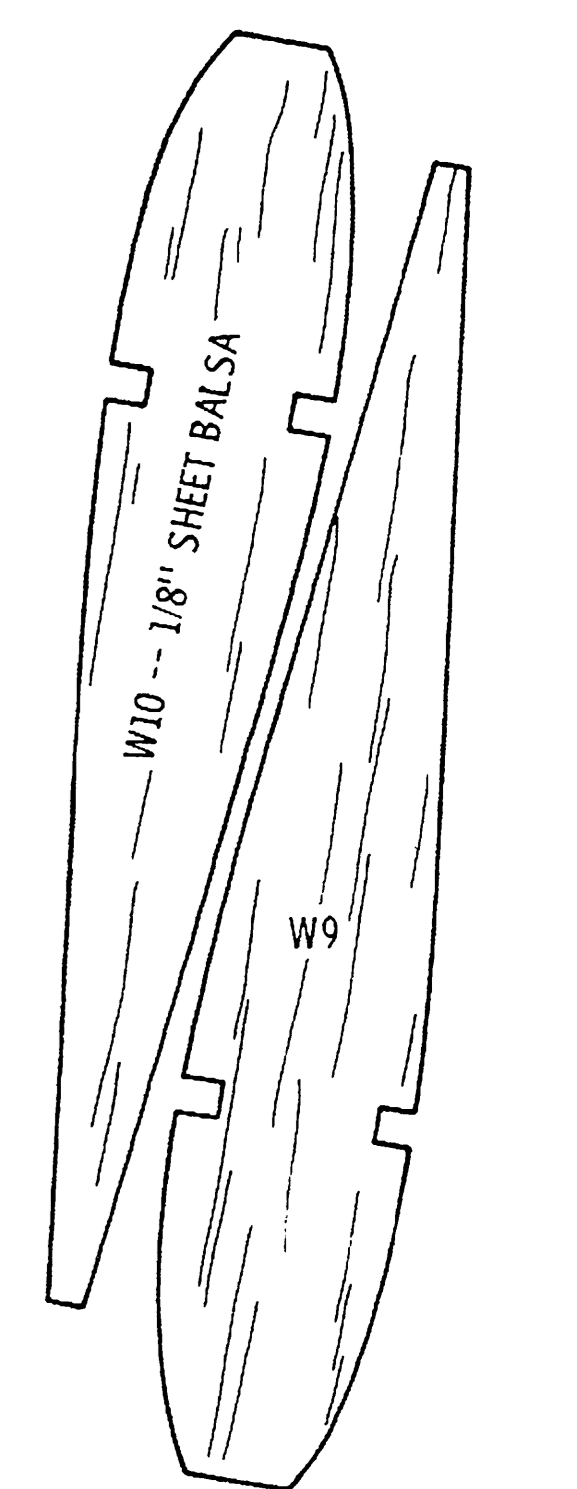
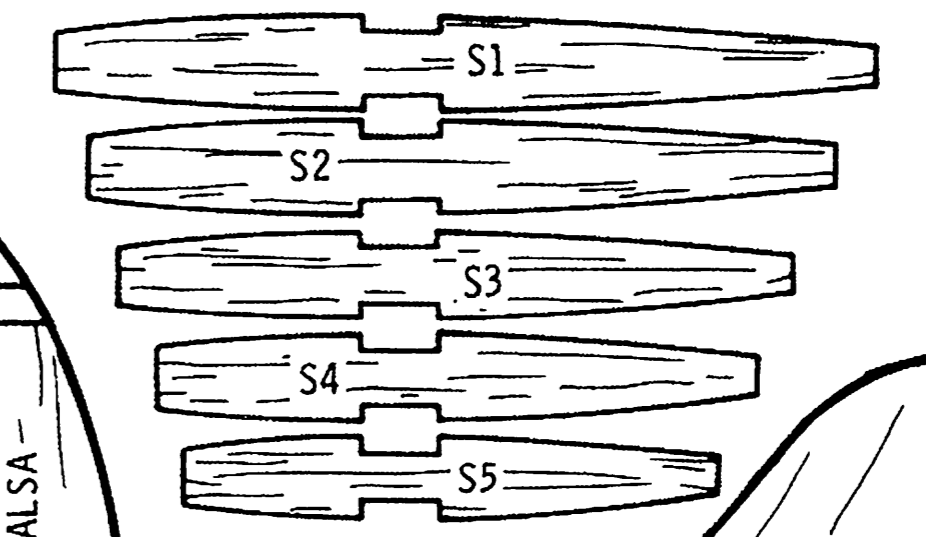

**R/C modeler TOKYO-ECHO**

DESIGNED BY AZUMA KUDO    DRAWN BY GEO. A. WALKER

1    2    3    4    5    6

ALL RIBS EXCEPT W1 & W10 TO BE CUT FROM 3/32" SHEET

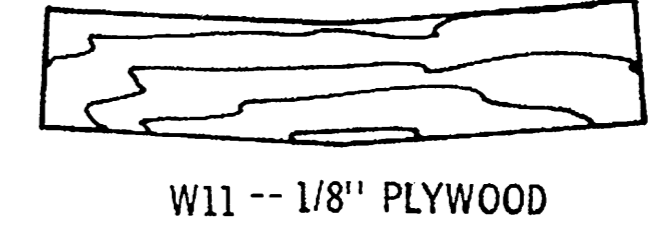

W11 -- 1/8" PLYWOOD

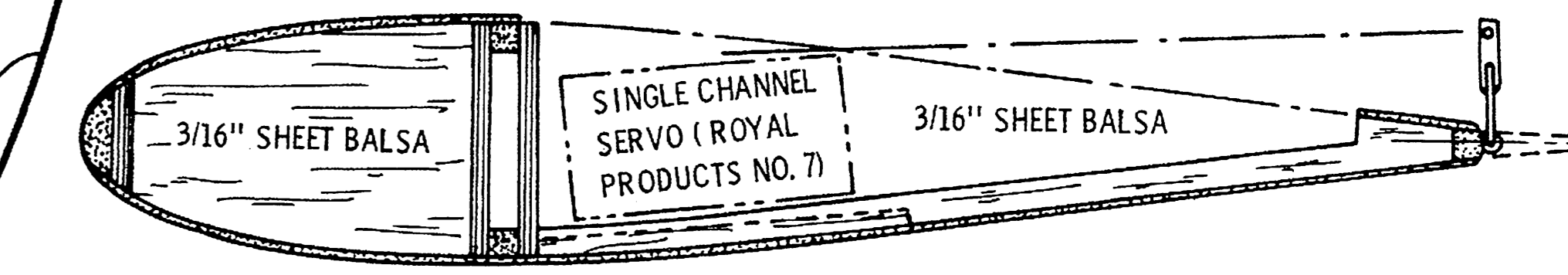

SINGLE CHANNEL SERVO (ROYAL PRODUCTS NO. 7)

W1

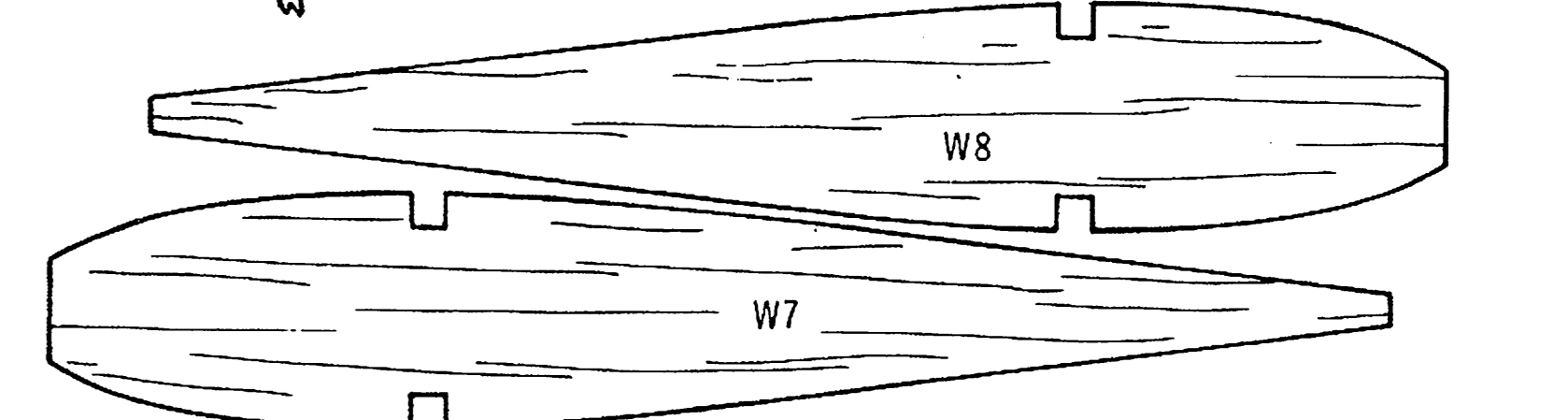

W7

W8

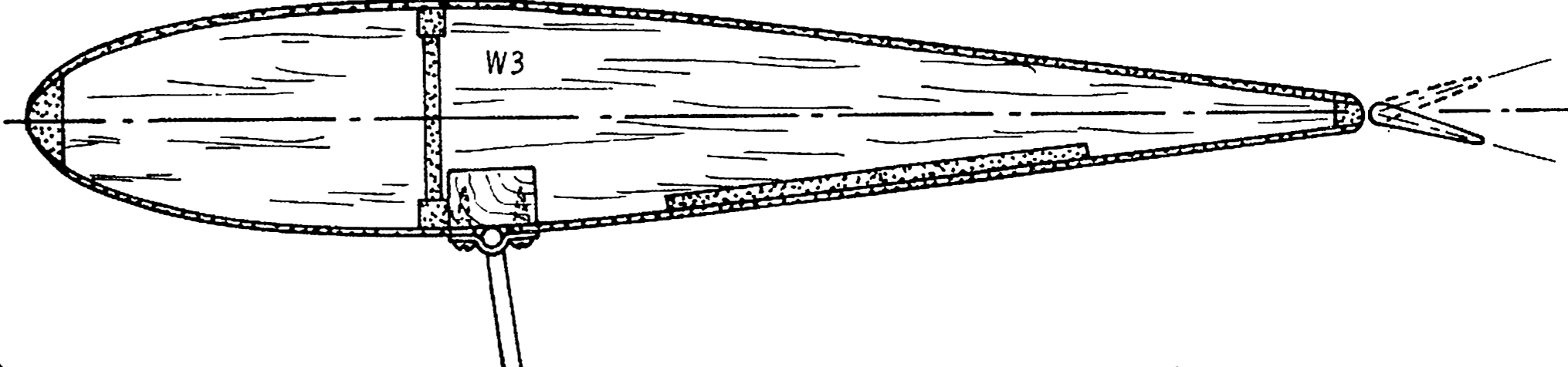

W3

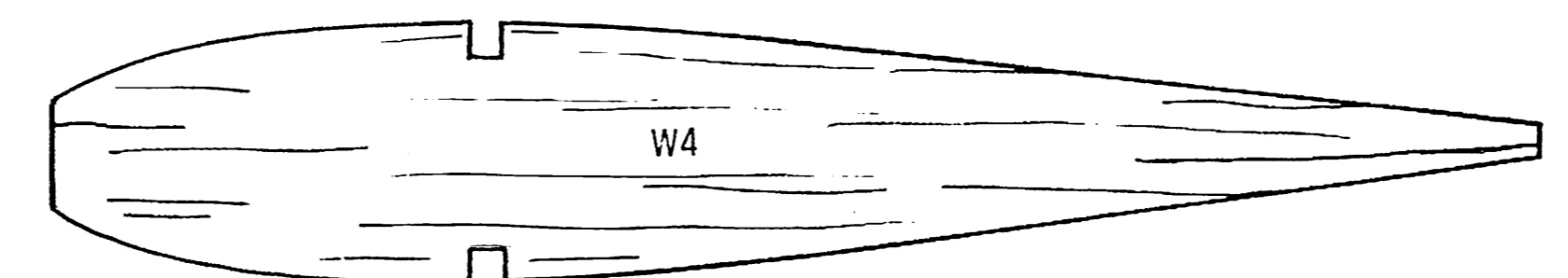

W4

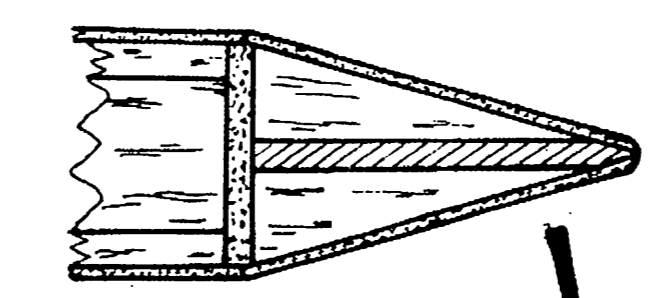

W5

W9

W10 -- 1/8" SHEET BALS

W6

W5

W3

W2

1/8" SHEET FUSelage SIDES

HARDWOOD

1/16" SHEET BALS

1/4" SQ BRACE

1/8" DOWELS

2" DIA WHEELS

RECEIVER BATTERIES

2 1/2" DIA NOSE WHEEL

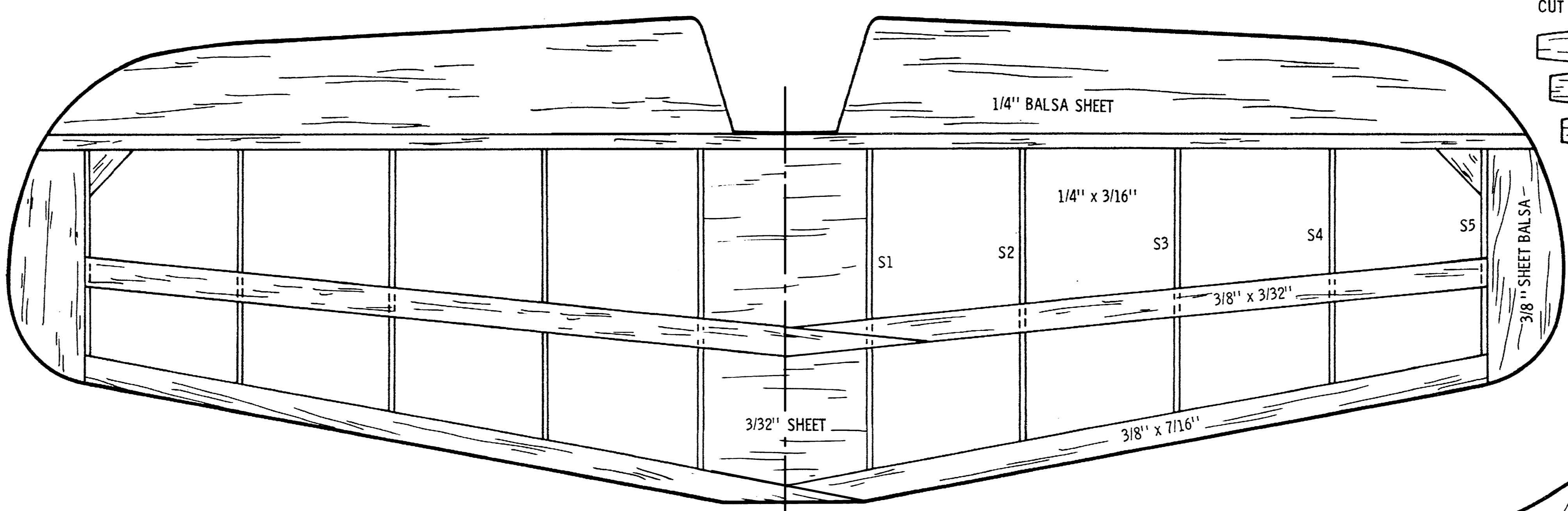
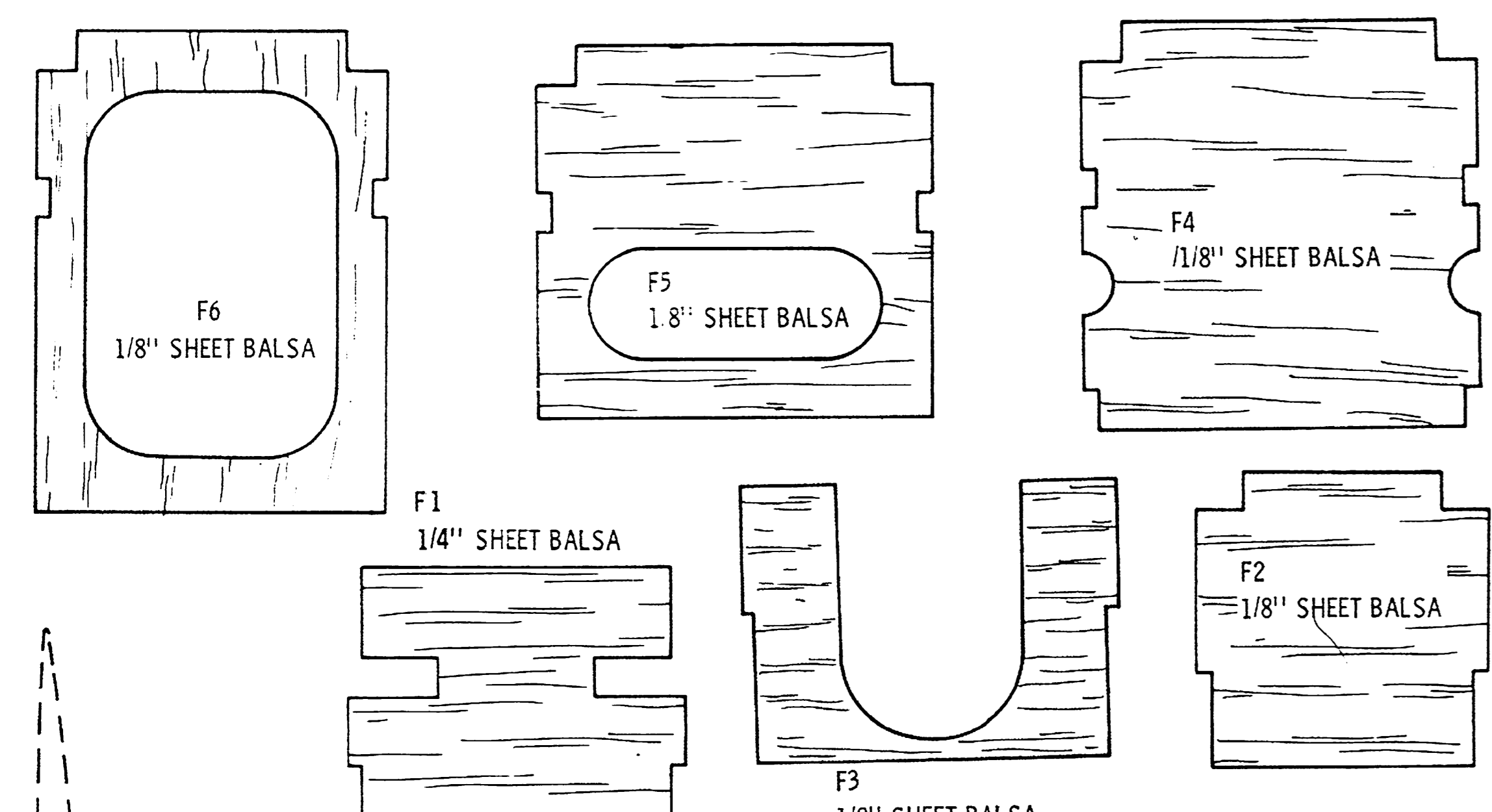
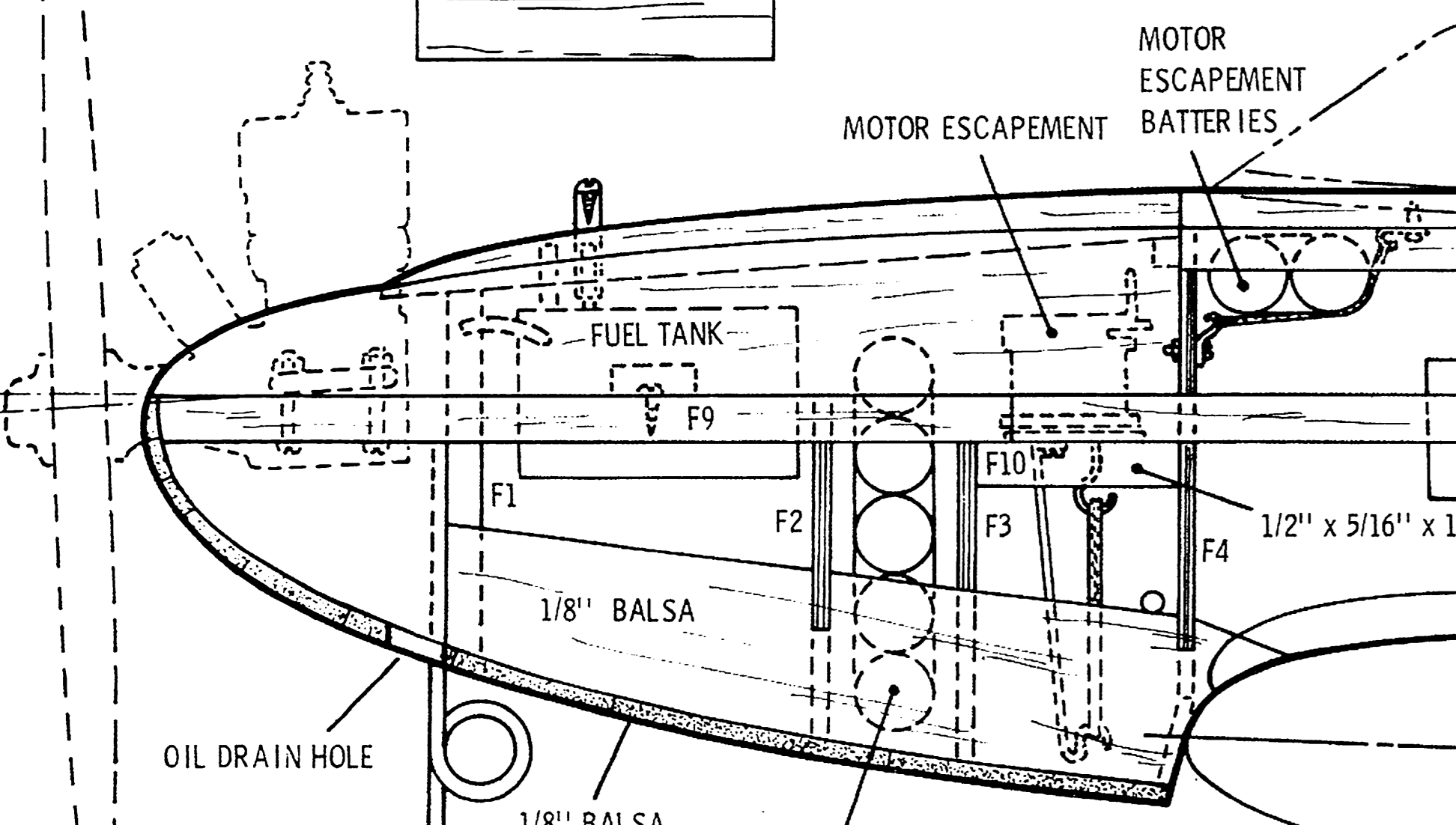

5 1/2" OVERALL DIHEDRAL

3/16" SHEET BALS AILERONS

7/8" x 1/16" BALS

1/8" SHEET REINFORCEMENT

3/16" SQ BALS

3/16" x 1/16" CAPSTRIPS

1/16" SHEAR WEB

1/16" SHEET BALS

3/16" SQ SPRUCE SPARS

5/8" x 1/4" LEADING EDGE

5/8" x 3/8" x 5 3/4" HARDWOOD

PLYWOOD SERVO MOUNT 2 1/2" x 1 5/8" x 1/8"

CLOTH & RESIN REINFORCEMENT

AILERON PUSHROD

AILERON PUSHROD

1/16" I. D. TUBING (SEWN TO WING)

HATCH COVER 6" x 3" x 1/2" BALS BLOCK

FUEL TANK

MOTOR ESCAPEMENT BATTERIES

RECEIVER

1/4" BALS SHEET

1/4" SHEET

3/32" SHEET

S1

S2

S3

S4

S5

3/8" x 7/16"

3/8" x 3/32"

1/4" x 3/16"

S1

S2

S3

S4

S5

5/16" SQ

3 5/8" x 1 8/8"

1/2" x 5/16" x 1 3/8"

1/8" BALS

1/8" BALS

1/8" BALS

1/8" BALS

1/8" BALS

F1

F2

F3

F4

F5

F6

F7

F8

F8

1/8" SHEET BALS

F7

1/8" SHEET BALS

W12 -- 1/8" PLYWOOD (2 REQUIRED)

W2

W3

W6

W5

W9

W10 -- 1/8" SHEET BALS

W6

W5

W3

W2