

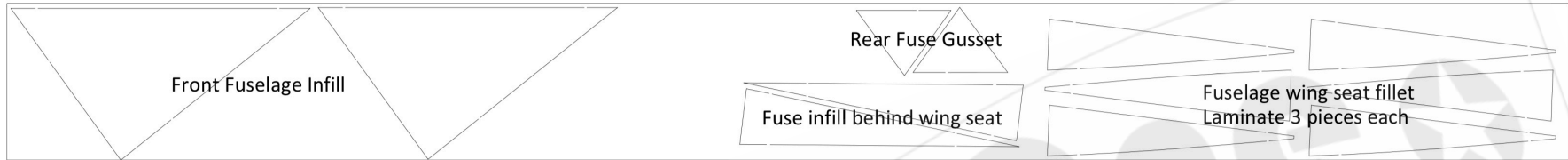

6.5 mm Balsa



6.5 mm Balsa



5.0 mm Balsa



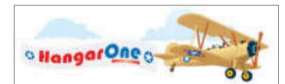
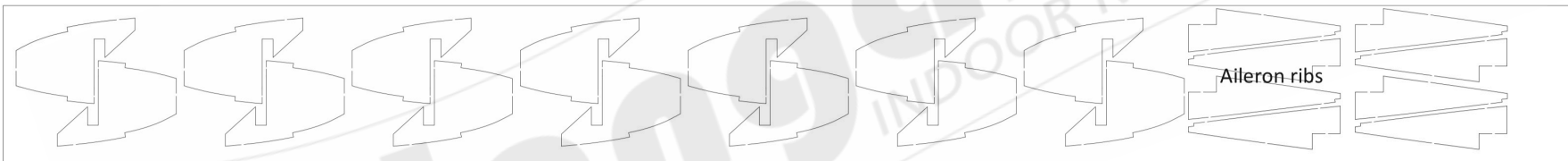
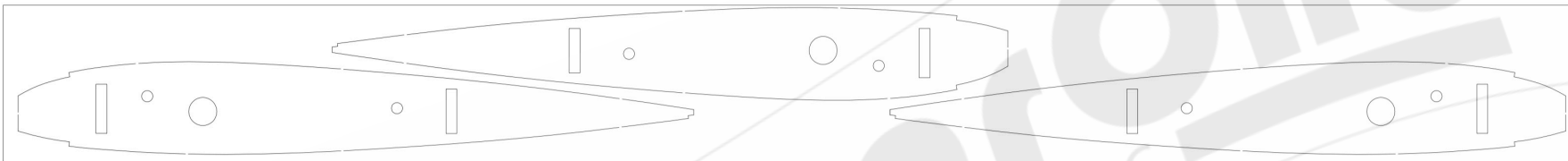
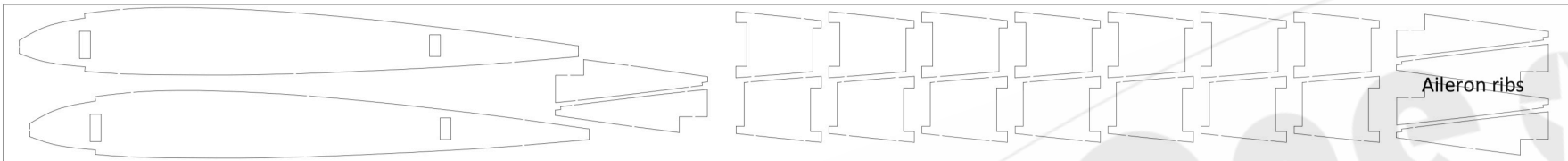
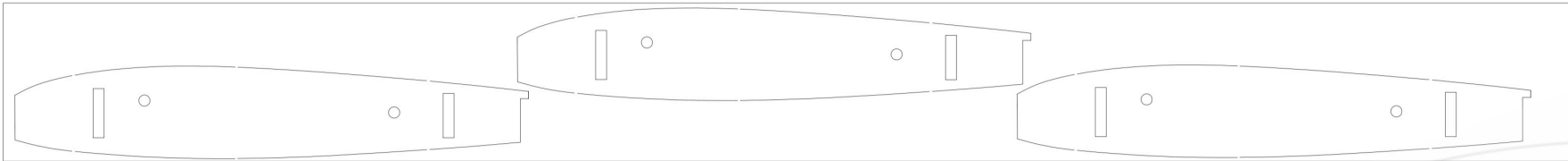

Taylorcraft BC12-D
Parts List

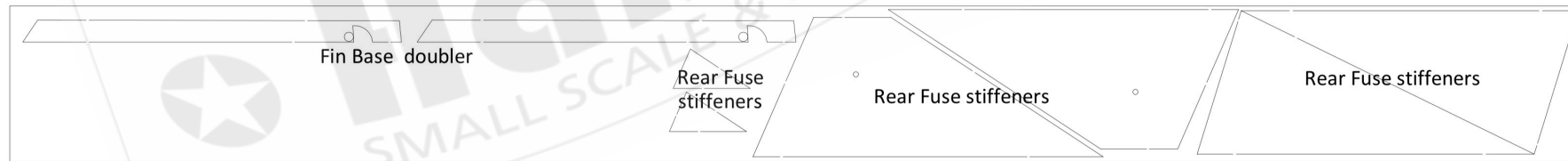
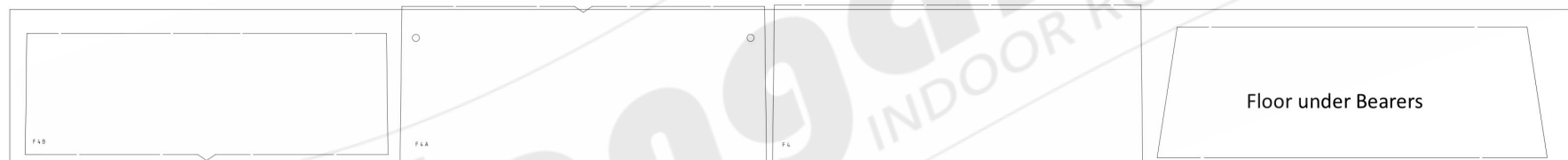
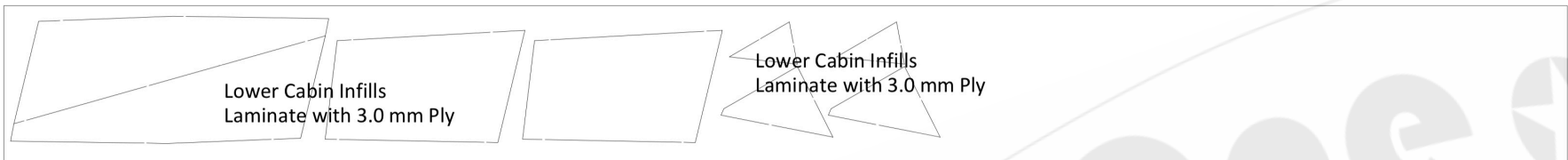
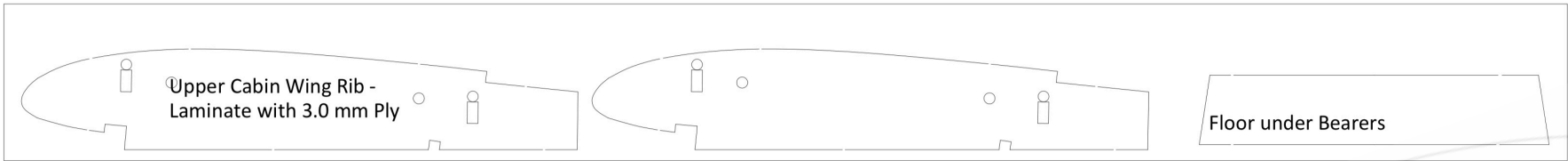

Taylorcraft BC12-D
Parts List

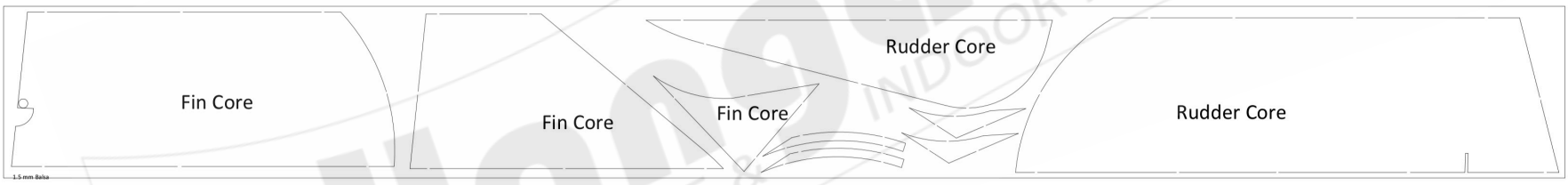
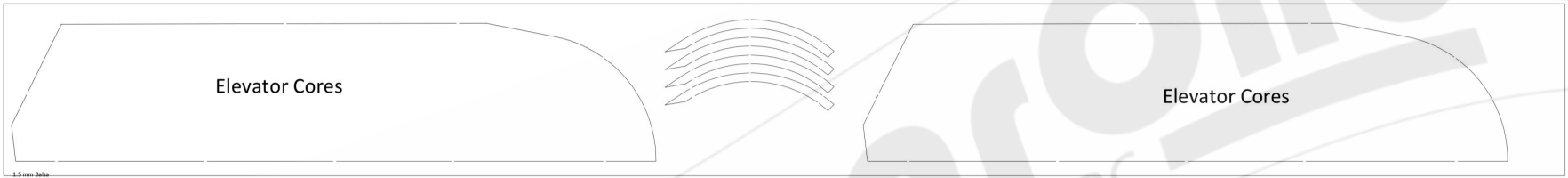
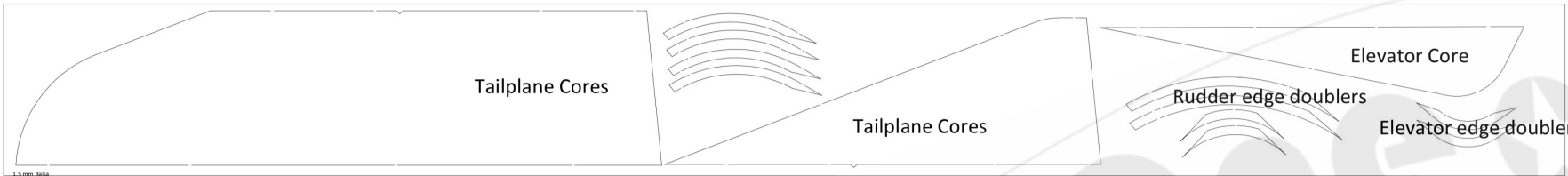
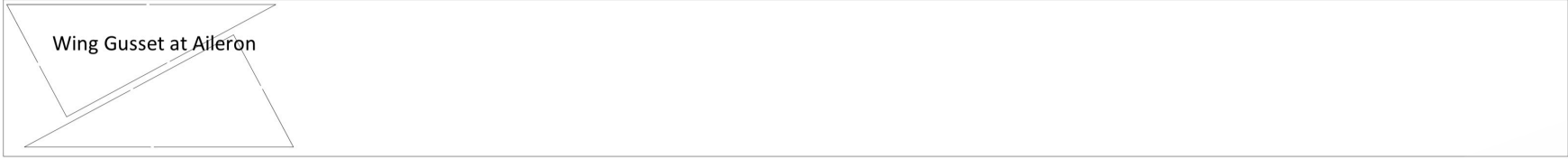

HangarOne
SMALL SCALE & INDOOR RC



Taylorcraft BC12-D
Parts List

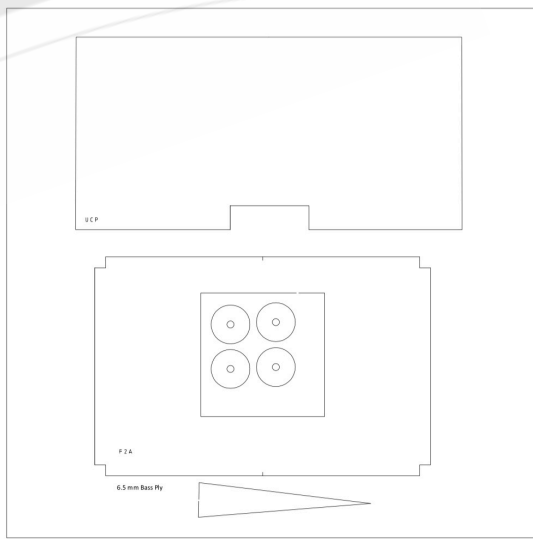
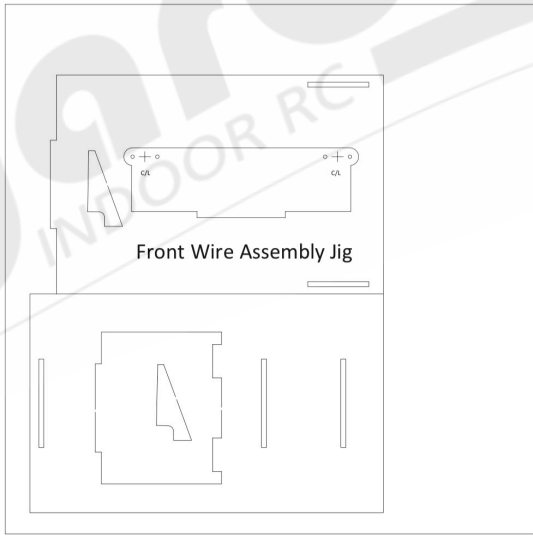
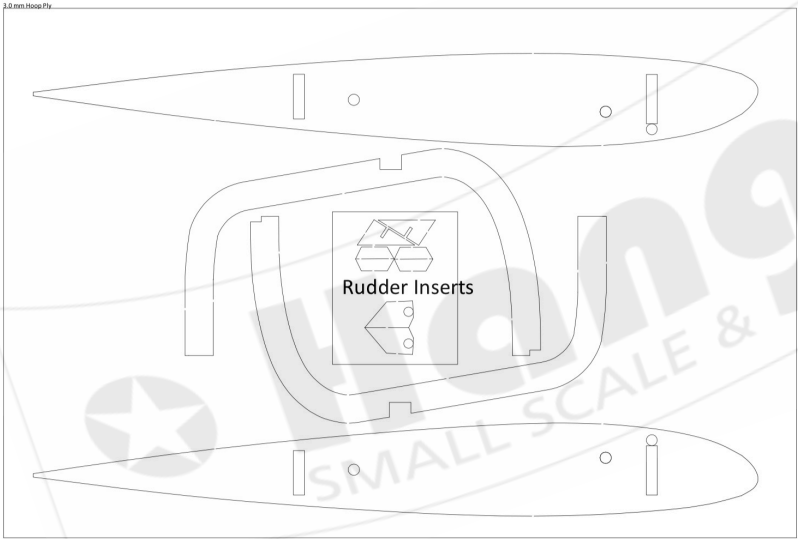
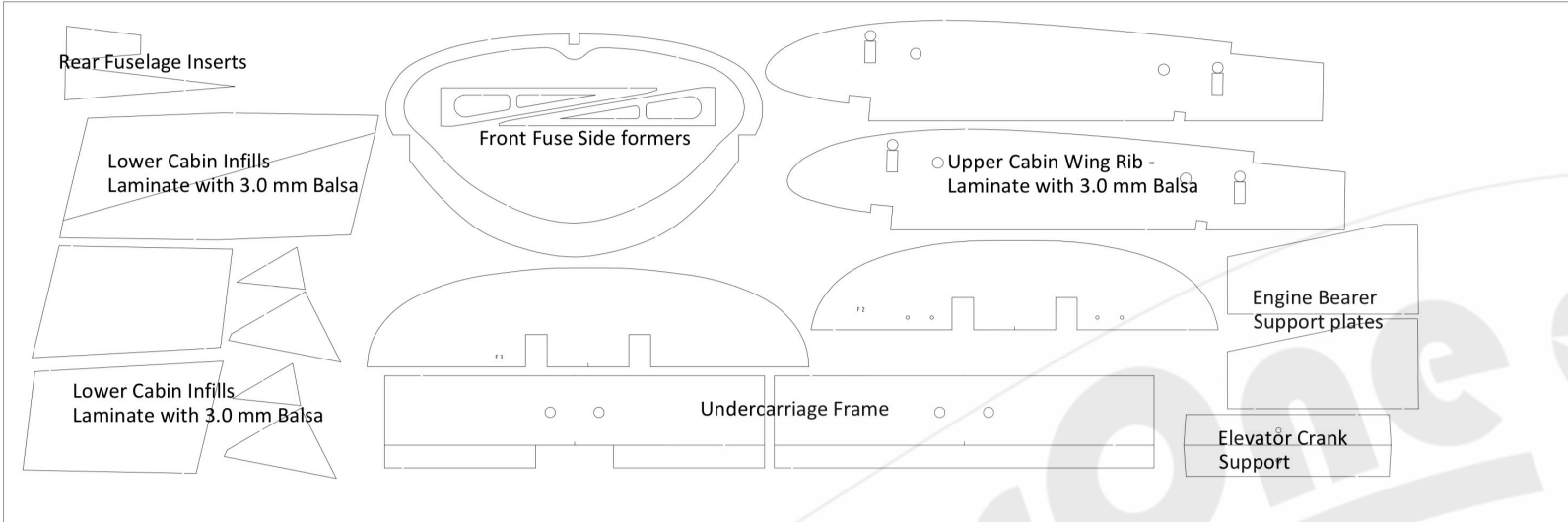

Taylorcraft
BC12-D
Parts List

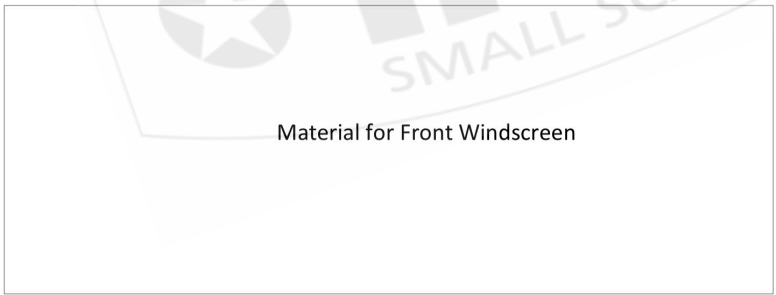
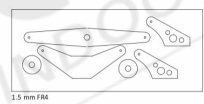
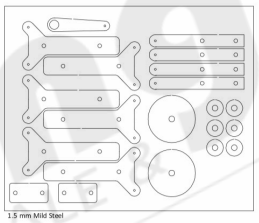
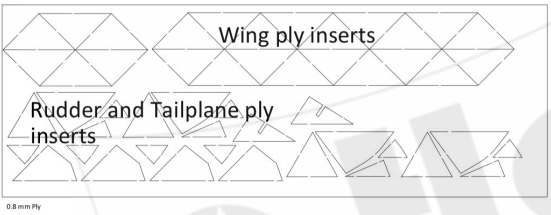
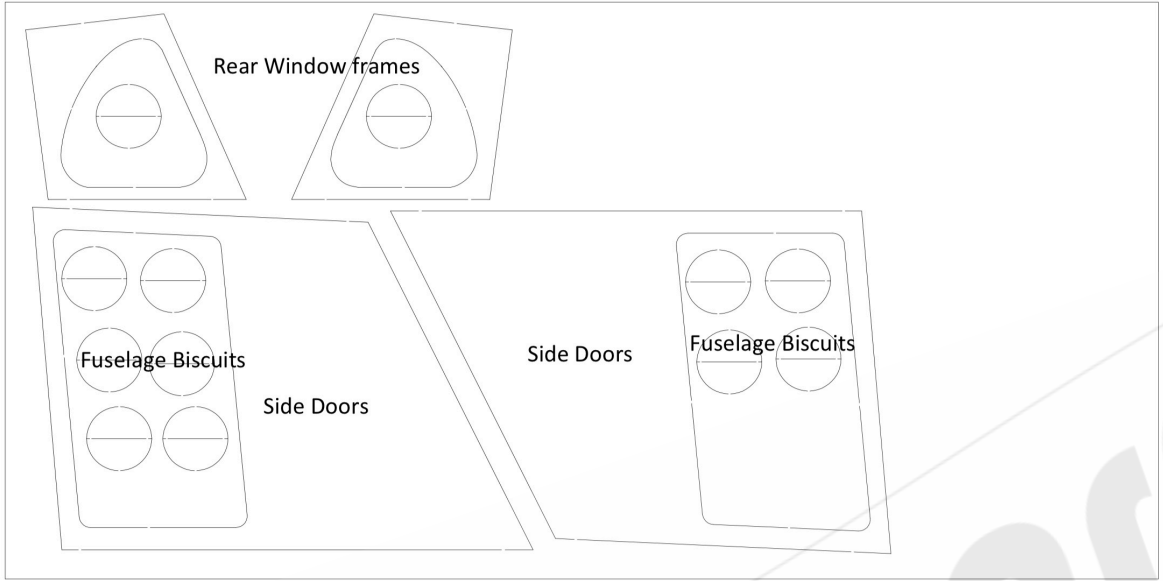

Taylorcraft BC12-D
Parts List

Main Spar - 1.125" x 0.25"
Laminate as shown with slow setting
epoxy or high quality wood glue.
Make from Spruce or Basswood
0.5" x 0.25" x 48" - 2 off
0.25" x 0.125" x 48" - 1 off

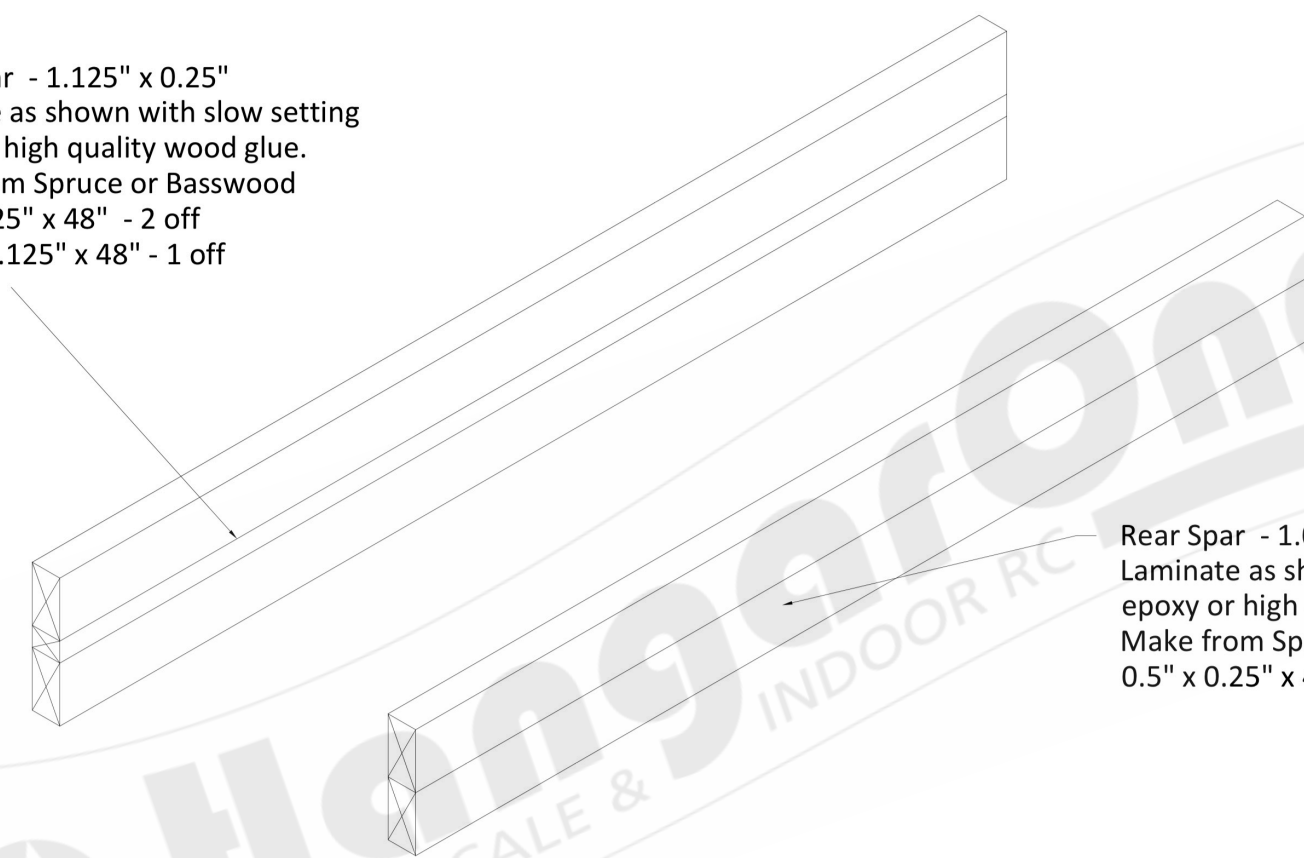

Rear Spar - 1.0" x 0.25"
Laminate as shown with slow setting
epoxy or high quality wood glue.
Make from Spruce or Basswood
0.5" x 0.25" x 48" - 2 off



Taylorcraft BC12-D
Laminated Spar
Detail