

Get started with your building kit

Greenscape Village

Architectural Building Blocks | www.arckit.com



Proudly
made in
Ireland





Hello,

Welcome to your new Greenscape Village kit!

I hope that it sparks many moments of imaginative play and wonderment whether you're building alone, together with family and friends or in your classroom.

As an architect, I had an idea to create an easier and more affordable way of building scaled architectural models other than by cutting and gluing materials together for one time usage. The result is Arckit, a collection of reconfigurable, interconnecting components inspired by real modular building methods that let you continuously explore and visualise your architectural ideas with speed and precision.

At the very heart of Arckit is an entirely 'open-ended' tool kit of parts for all ages and which encourages learning while having fun. Each component has multiple uses and every kit has a myriad of design possibilities for you to reveal, allowing you to freely express your designs without limitations or restrictions of instructions. I liken Arckit to any instrument, the more you engage with it, the more proficient you become and the more amazing undiscovered creations you will start to bring to life.

Happy Building!

A handwritten signature in black ink, appearing to read "Damien". The signature is fluid and cursive, with a prominent loop at the end.

Damien
Founder CEO

Architectural Components Set:

Half Wall Panels

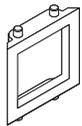

x16
37020205

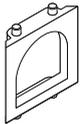

x16
37030205



x12
37040205

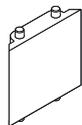

x8
37010205

Floor & Roof Tiles

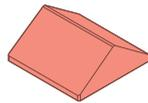

x2
16090615



x2
17090604

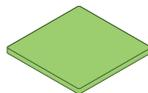

x8
15080501



x2
21090608



x2
20090607

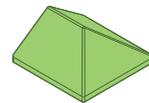

x2
19090606

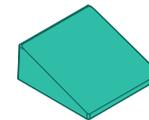

x2
26090613

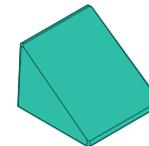

x2
27090614

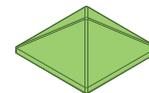

x2
18090605

Floor & Roof Modules



x6
11120101

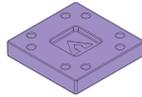

x6
11140101

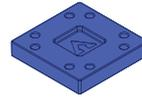

x6
11130101

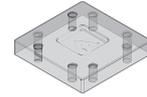

x6
11020101

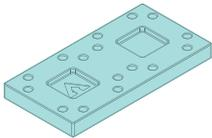

x6
11120102

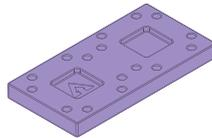

x6
11140102

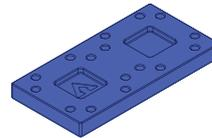

x6
11130102

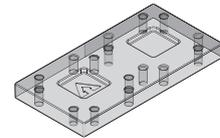

x6
11020102

Let's build a better world!

Greenscape Village - Sample Building #1

Greenscape Village is an environmentally friendly land of colourful buildings and interesting shapes amidst beautiful streams and vegetation. It's envisaged as a clean, green & self-sustainable community, powered only by nature. There you'll find wind turbines, solar panels and environmentally conscientious residents growing their own food, exercising in the park and whizzing around on their bikes and electric scooters. Now, all we need is for you to bring your eco-village to life.

Remember, the following sample building instructions are simply to familiarise you with Arckit's continually reconfigurable platform before setting you on your way to your own amazing creations. Go online for a further 3+ Village building design ideas.



Use the QR code to access exciting 3D construction videos and more building ideas with instructions!

www.arckit.com

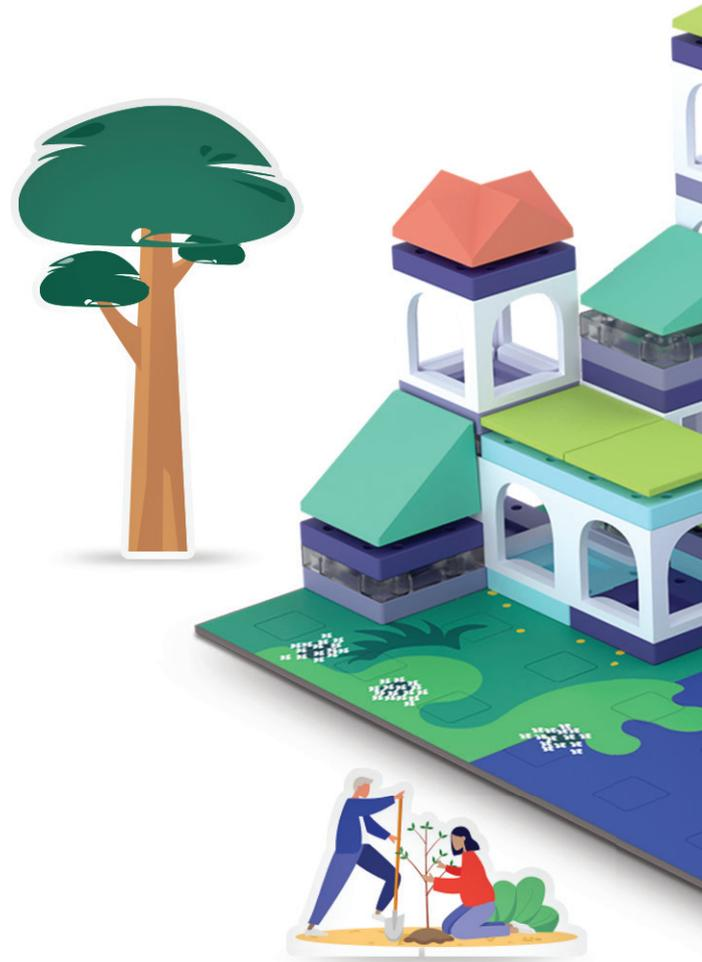



Part A



x3
37020205



x1
37030205



x5
37040205



x2
37010205



x2
16090615



x1
15080501



x1
27090614



x1
21090608



x3
11120101

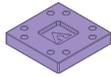

x1
11140101

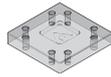

x1
11020101

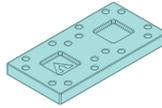

x1
11120102

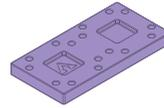

x1
11140102

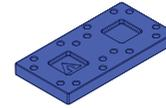

x1
11130102

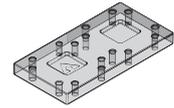

x1
11020102

- 1.** Pop-out the slots on the building plate before inserting the modules.

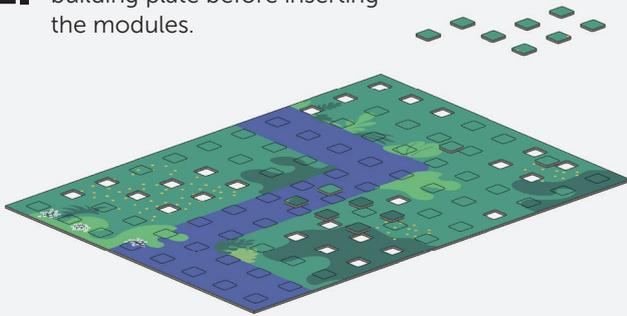

- 2.**

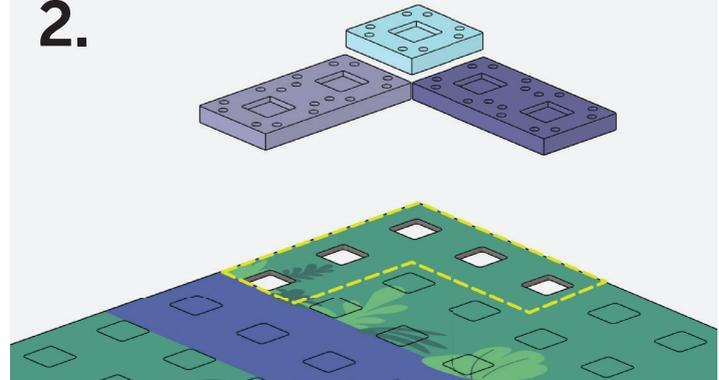

3.

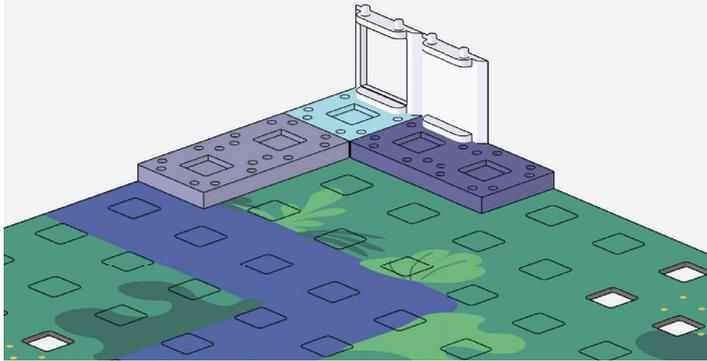

4.

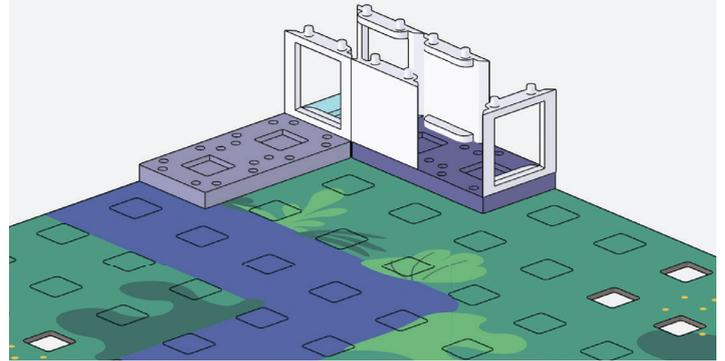

5.

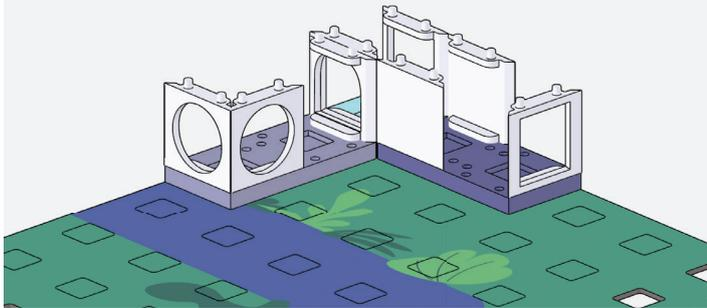

6.

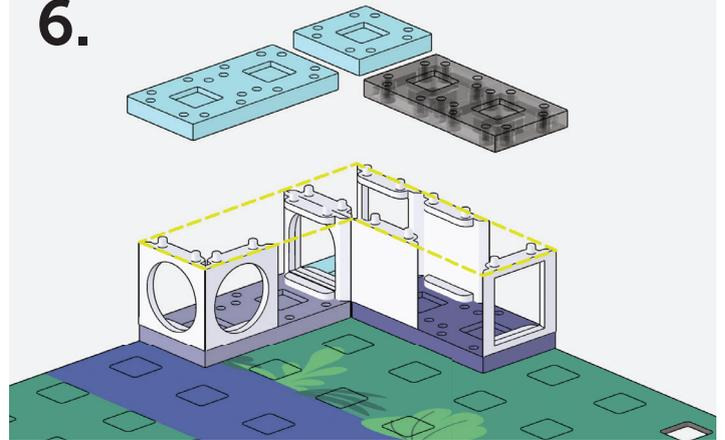

7.

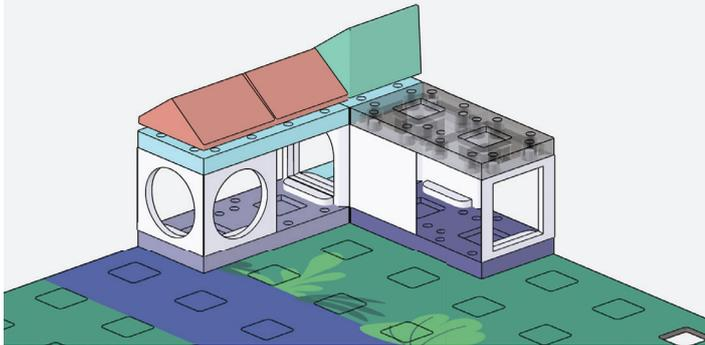

8.

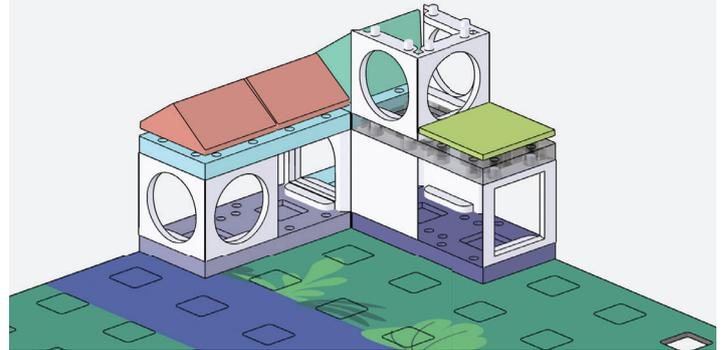

9.

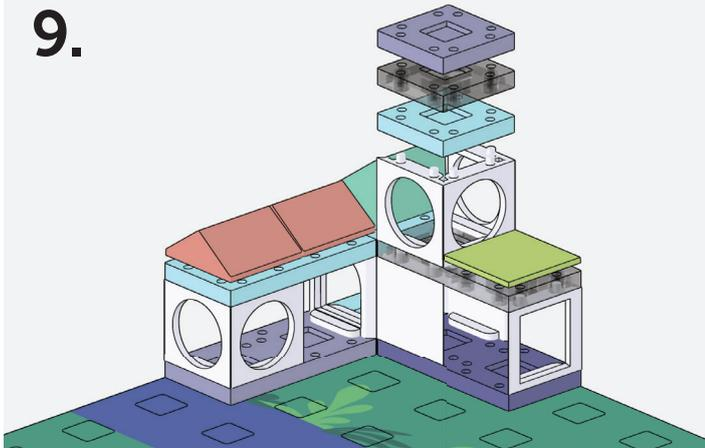

10.

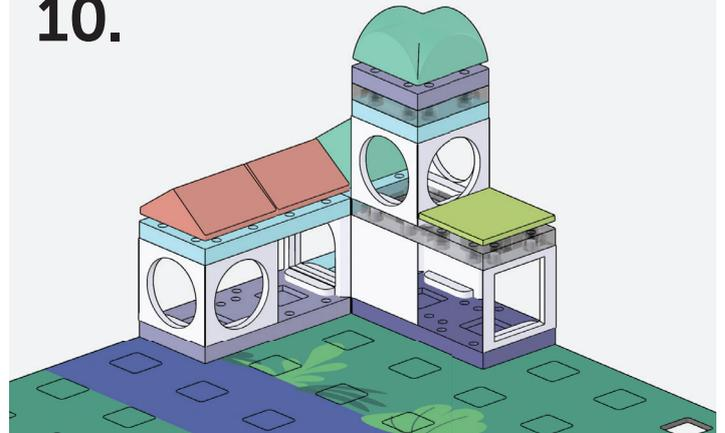

Part B



x1
37020205



x2
37010205



x2
19090606



x1
26090613

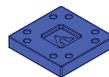

x1
11130101

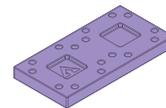

x1
11140102

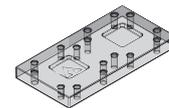

x2
11020102

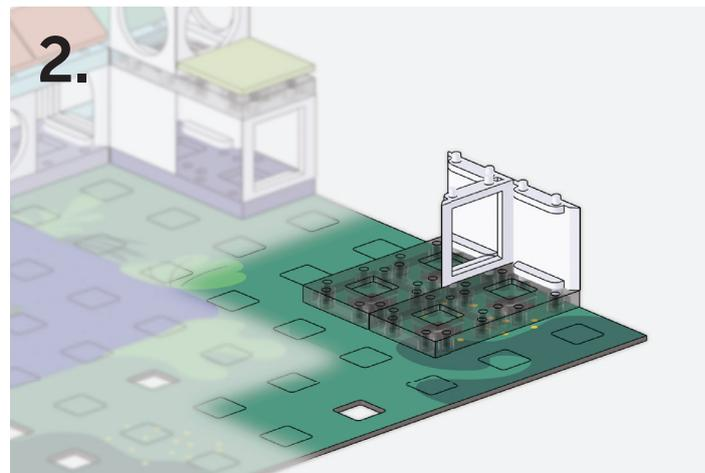
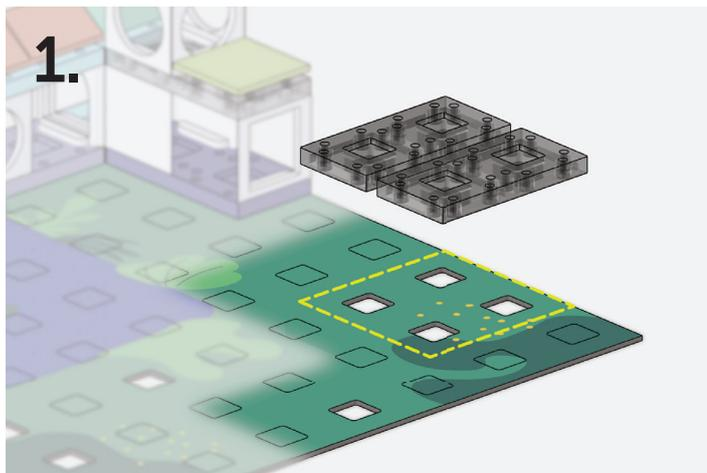

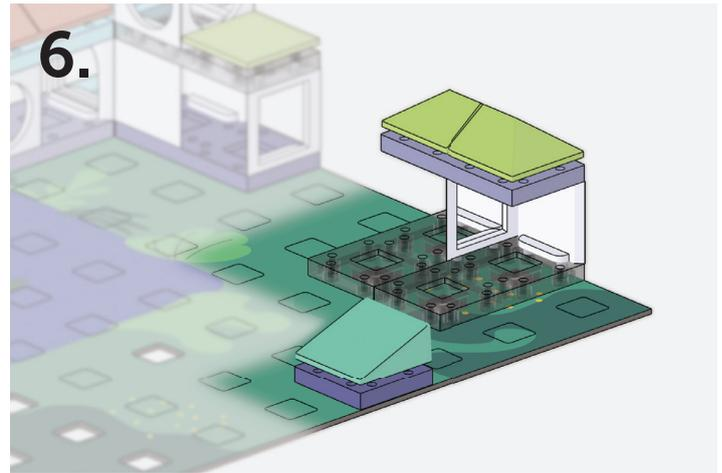
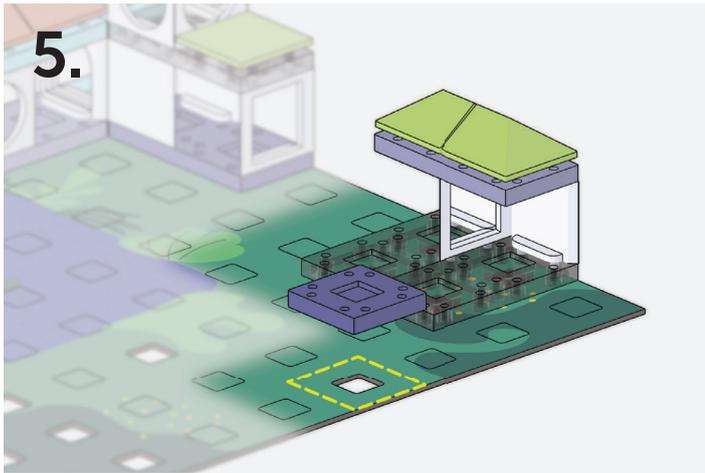
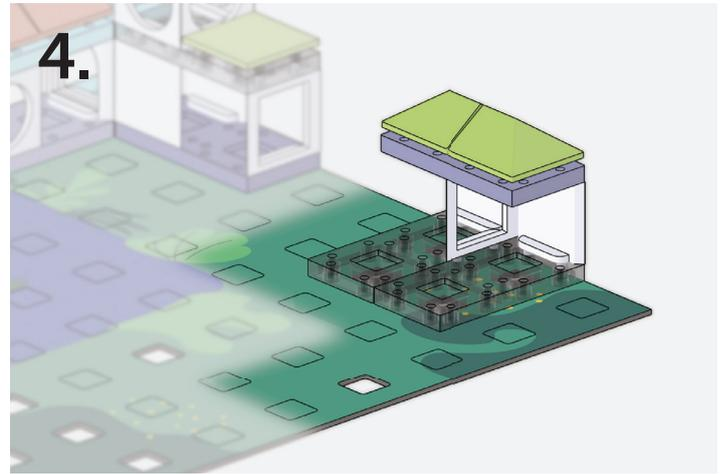
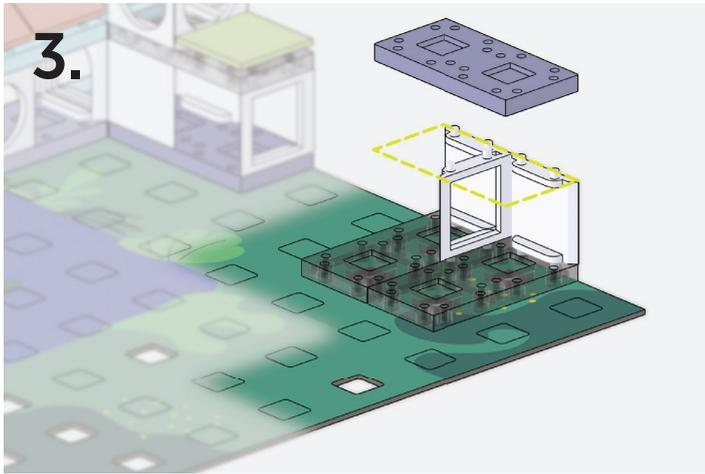

Part C



x3
37020205



x2
37030205



x1
37010205



x1
21090608



x1
11120101

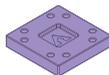

x1
11140101

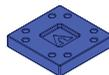

x1
11130101



x1
11020101

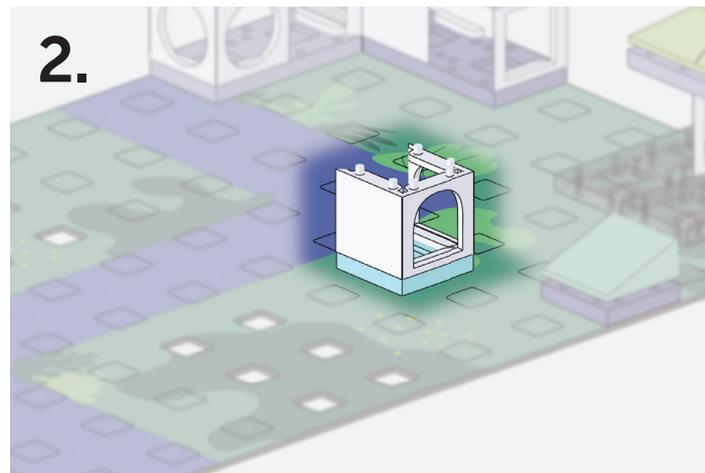
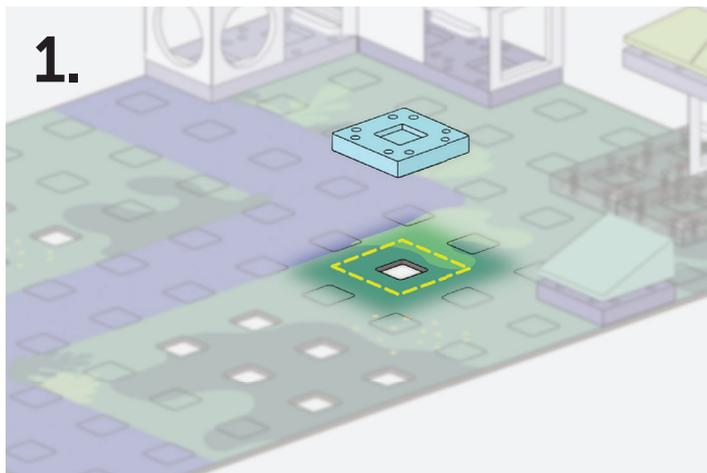

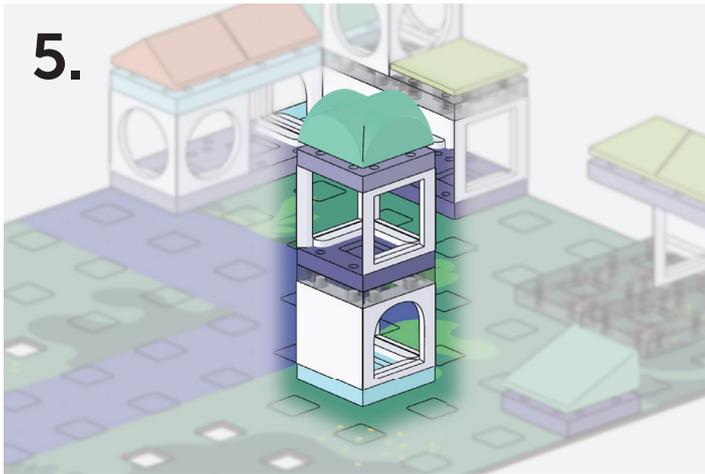
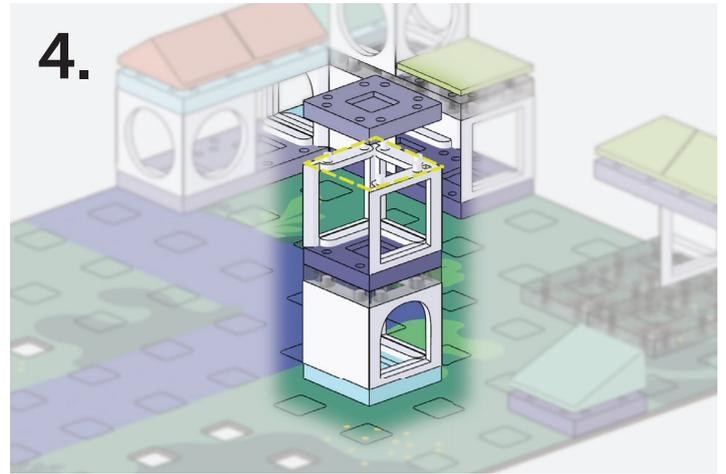
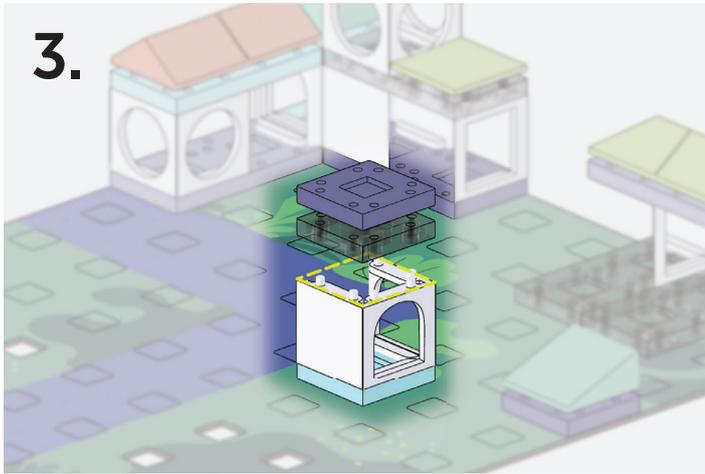

Part D



x6
37020205



x12
37030205



x4
37040205



x1
37010205



x1
17090604



x3
15080501



x1
18090605



x1
26090613



x1
27090614

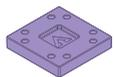

x2
11140101

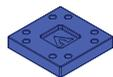

x1
11130101



x3
11020101

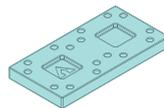

x4
11120102

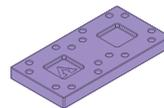

x2
11140102

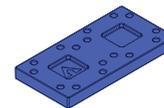

x3
11130102

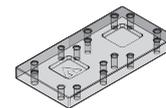

x2
11020102

1.

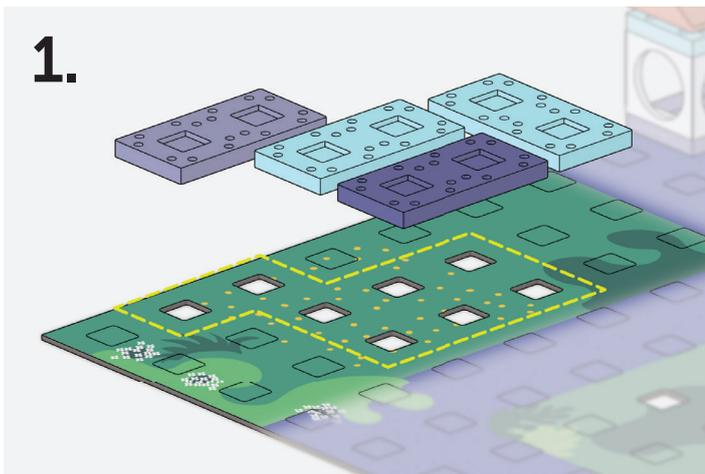

2.

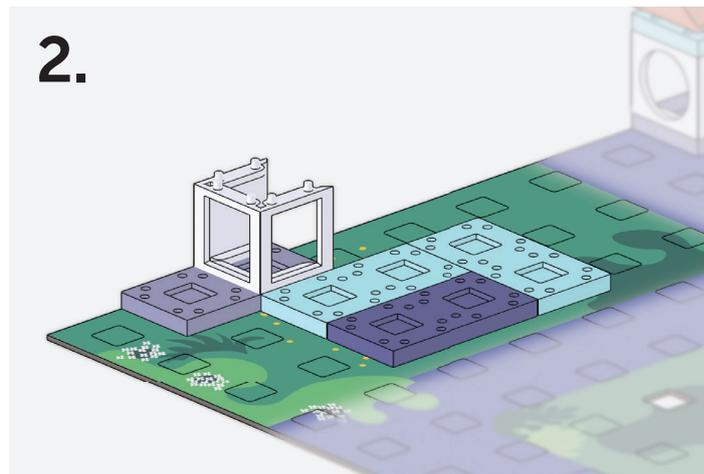

3.

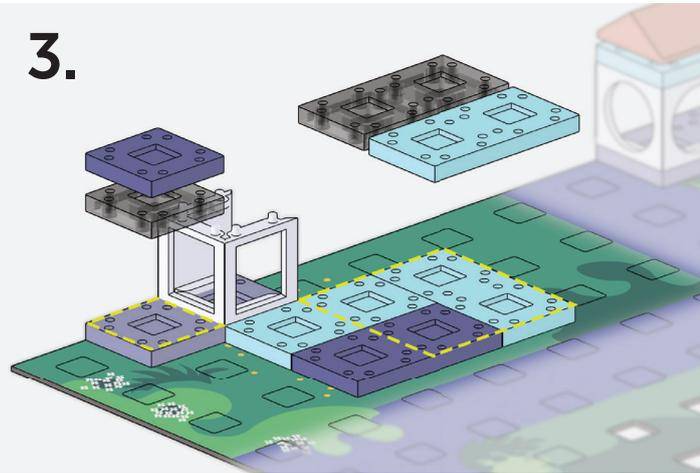

4.

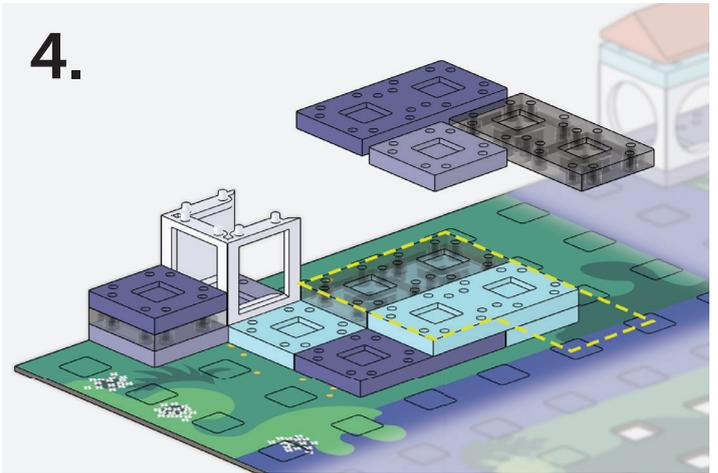

5.

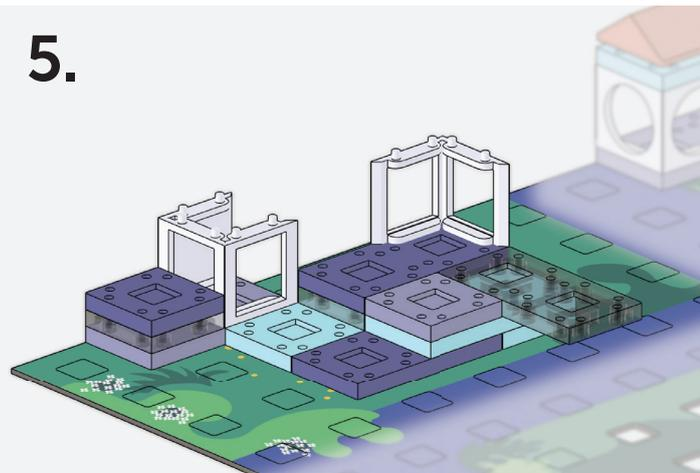

6.

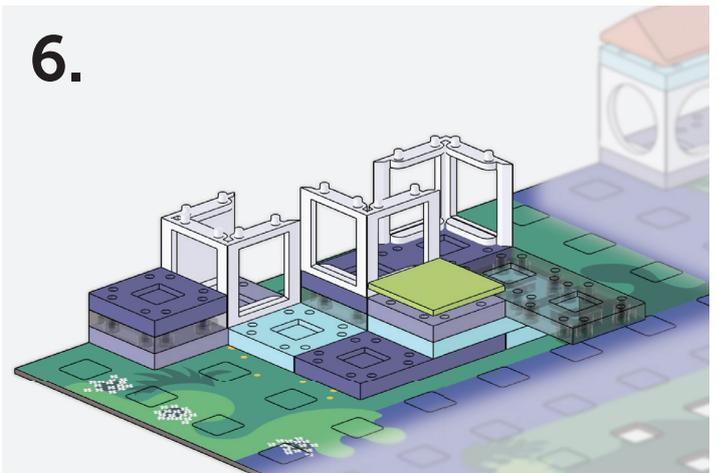

7.

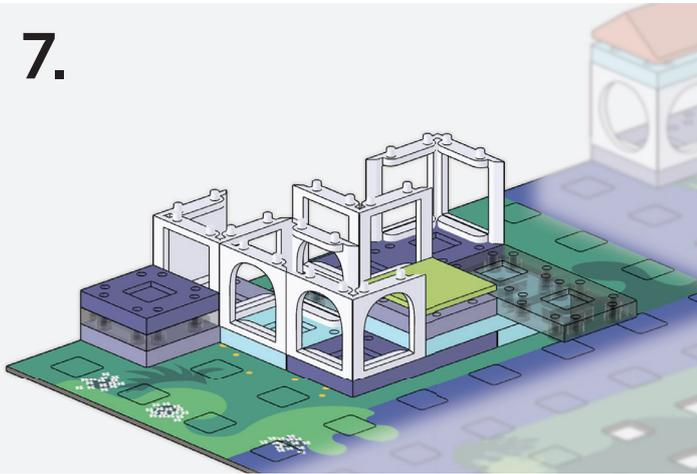

8.

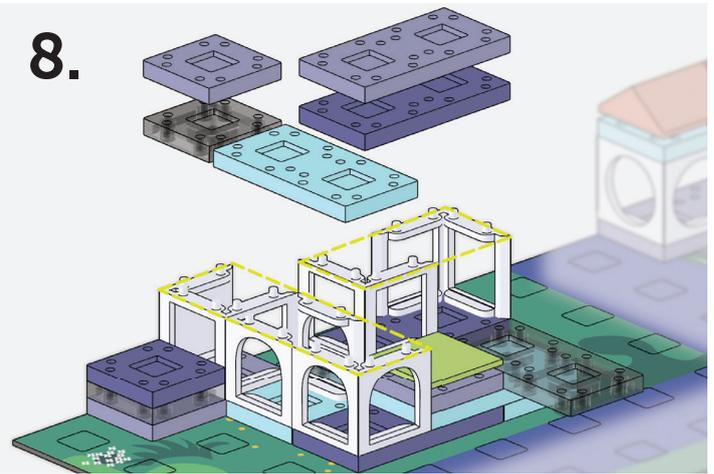

9.

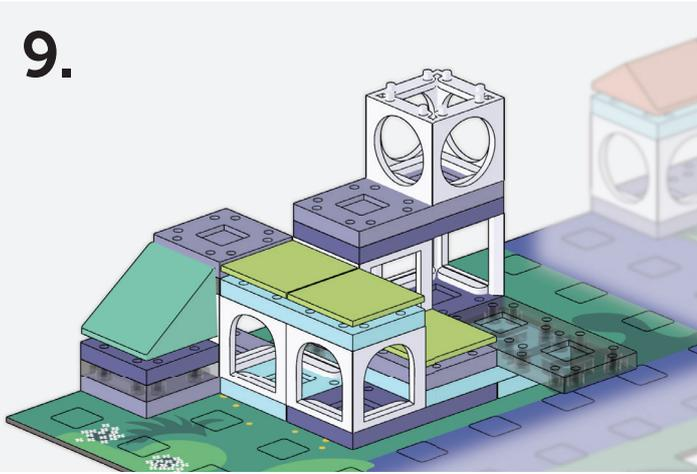

10.

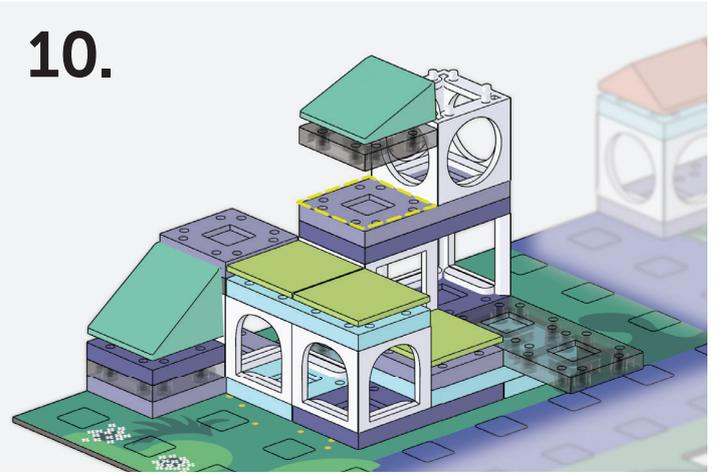

11.

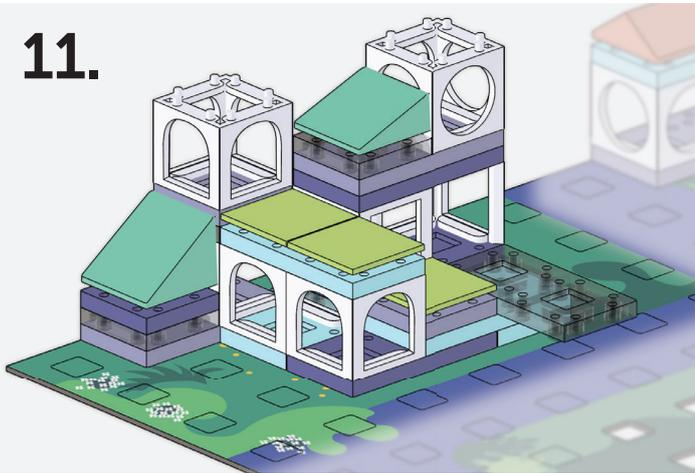

12.

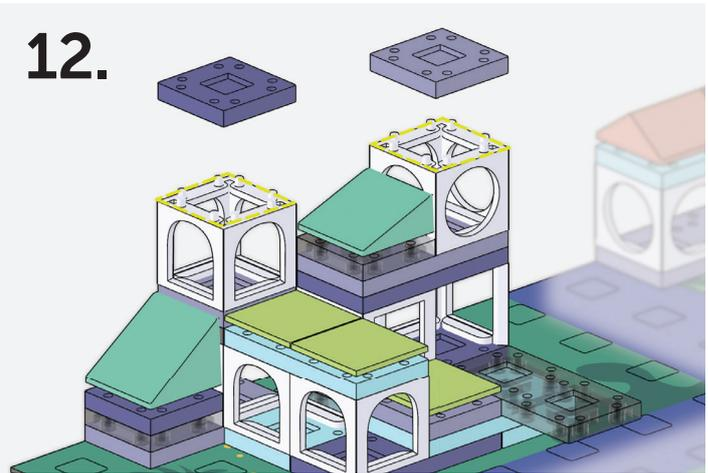

13.

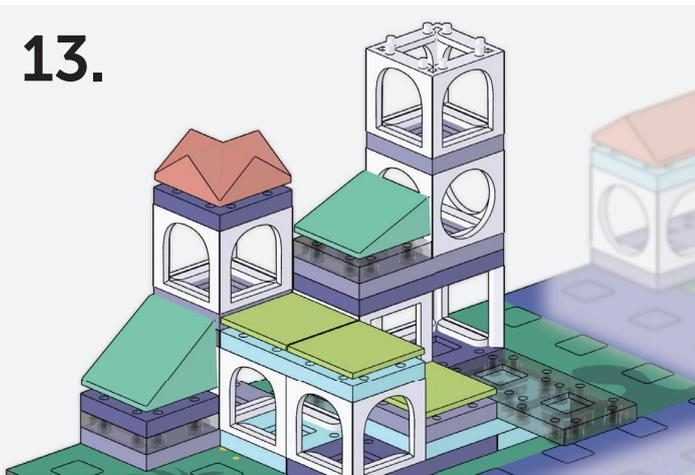

14.

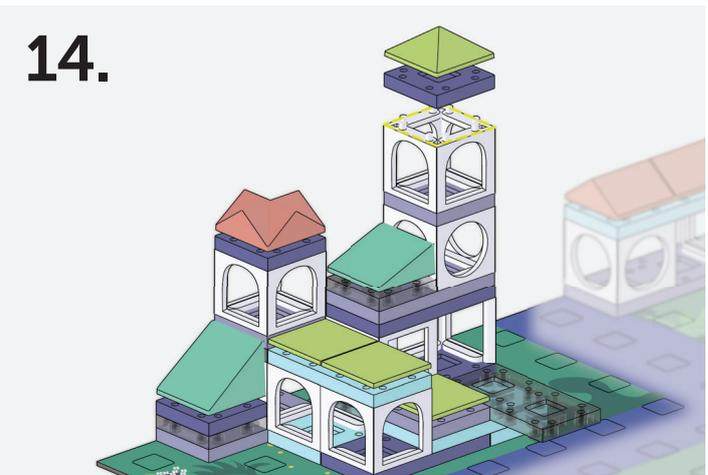

Part E

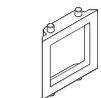

x3
37020205



x1
37030205



x3
37040205



x2
37010205



x1
17090604



x3
15080501



x1
18090605



x2
20090607

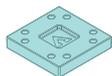

x1
11120101

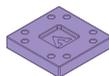

x1
11140101

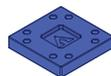

x1
11130101

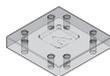

x1
11020101

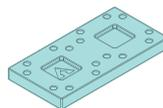

x1
11120102

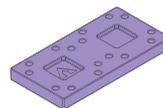

x2
11140102

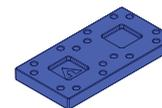

x2
11130102

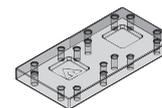

x1
11020102

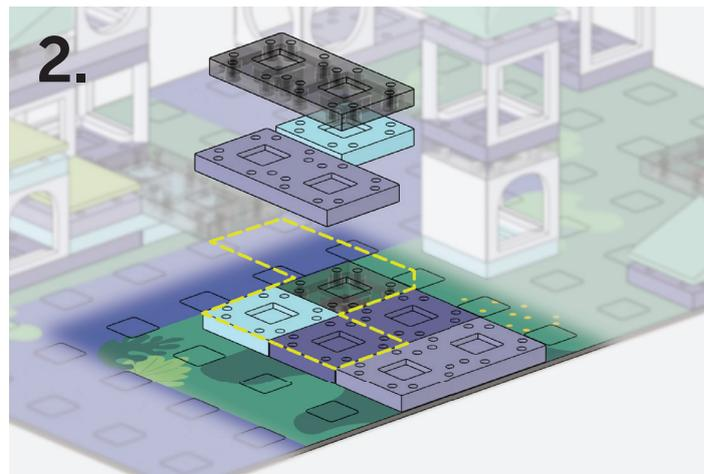
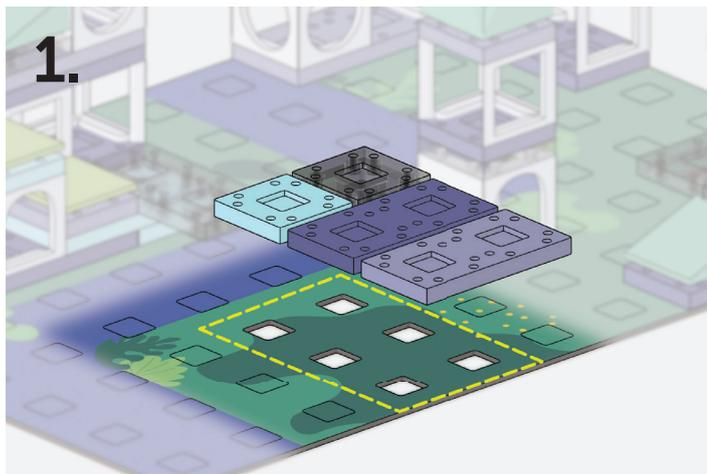

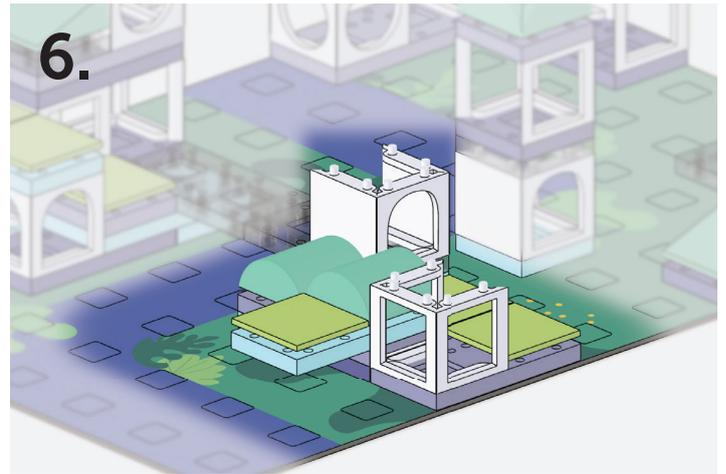
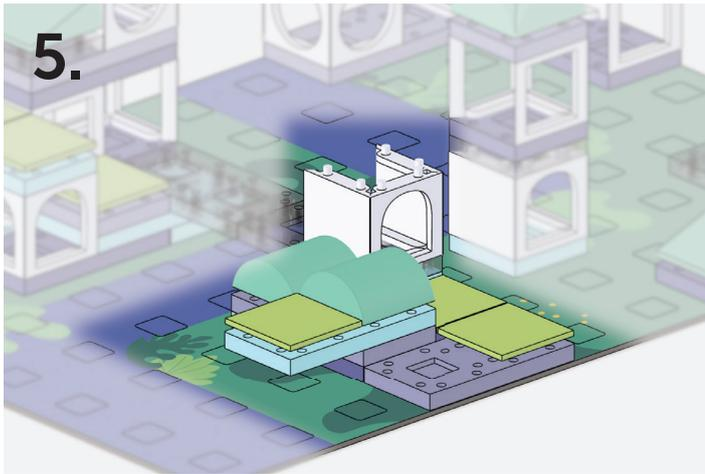
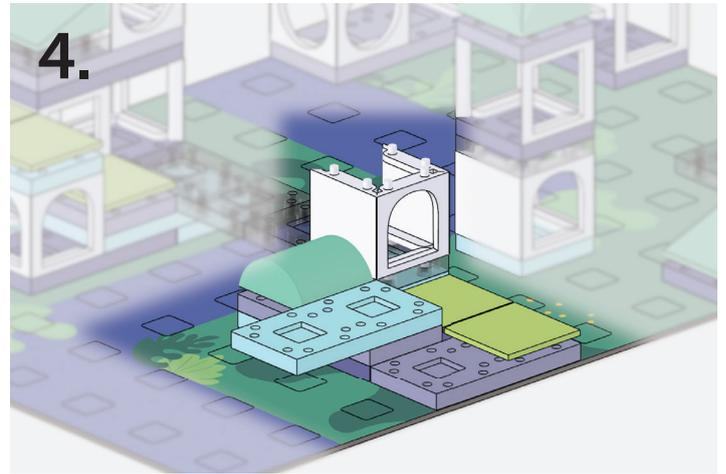
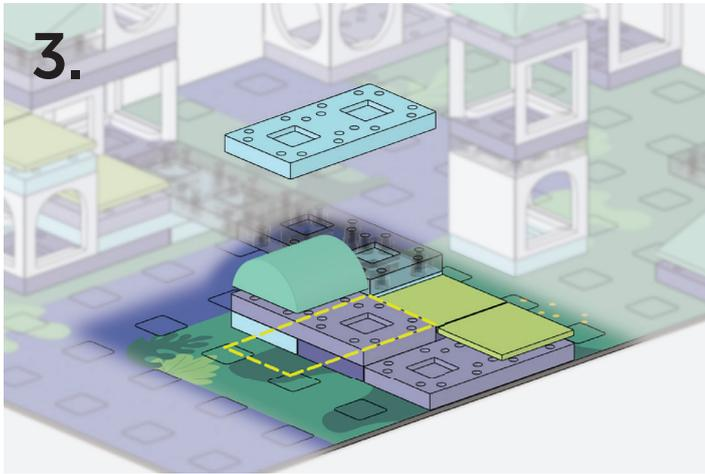

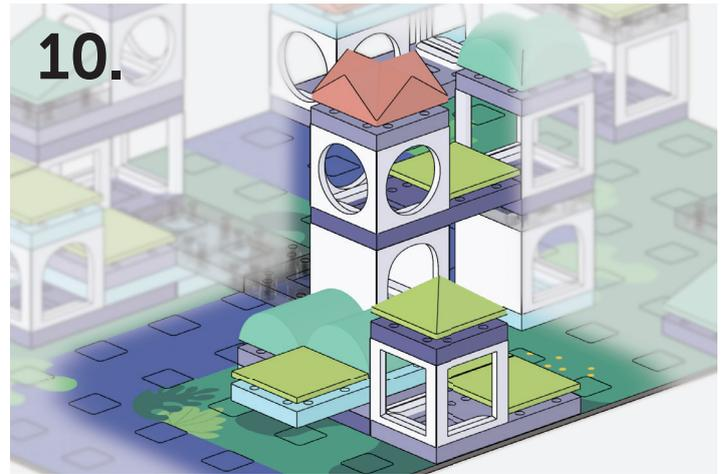
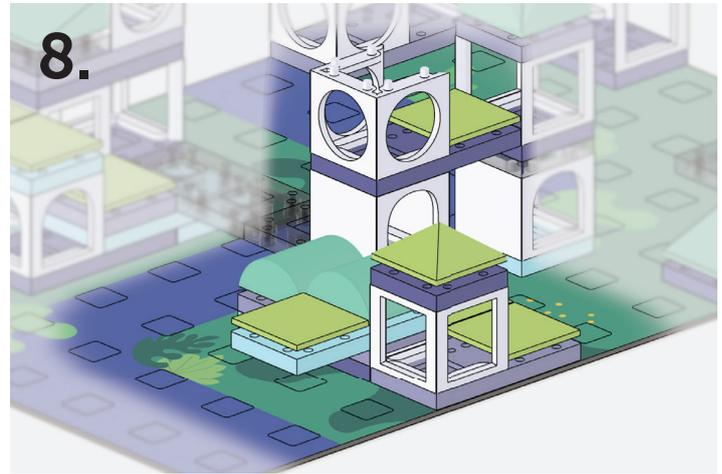
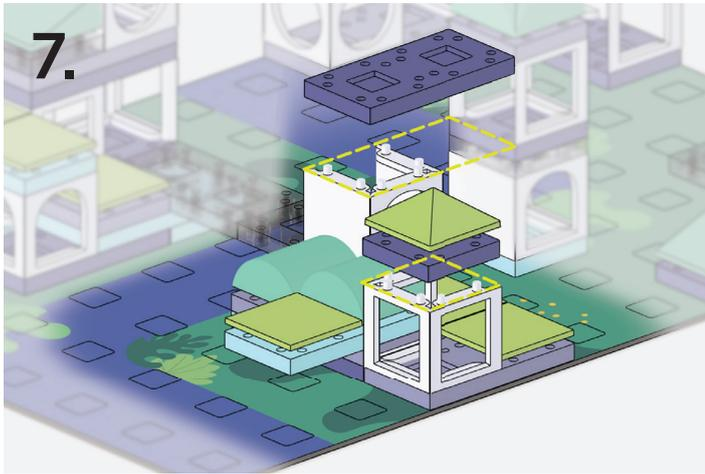

Bring it to life

CONGRATULATIONS! You finished your first sample building. Now, use your Greenscape Village Accessories Set to create unique scenes.

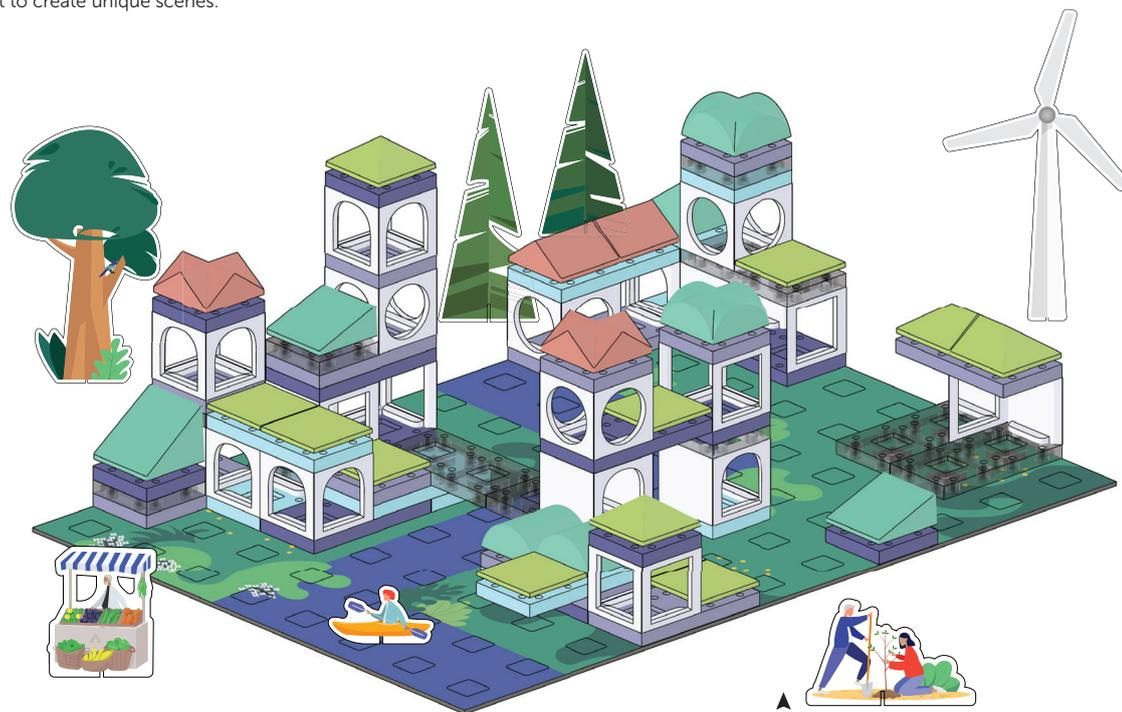

Slot the pop-out elements together to stand upright.

Now, what will you build next?

Keep building with your set and if you need some inspiration for your next creation, use the QR code to access exciting 3D construction videos and a further 3+ building ideas with instructions available online:



www.arckit.com

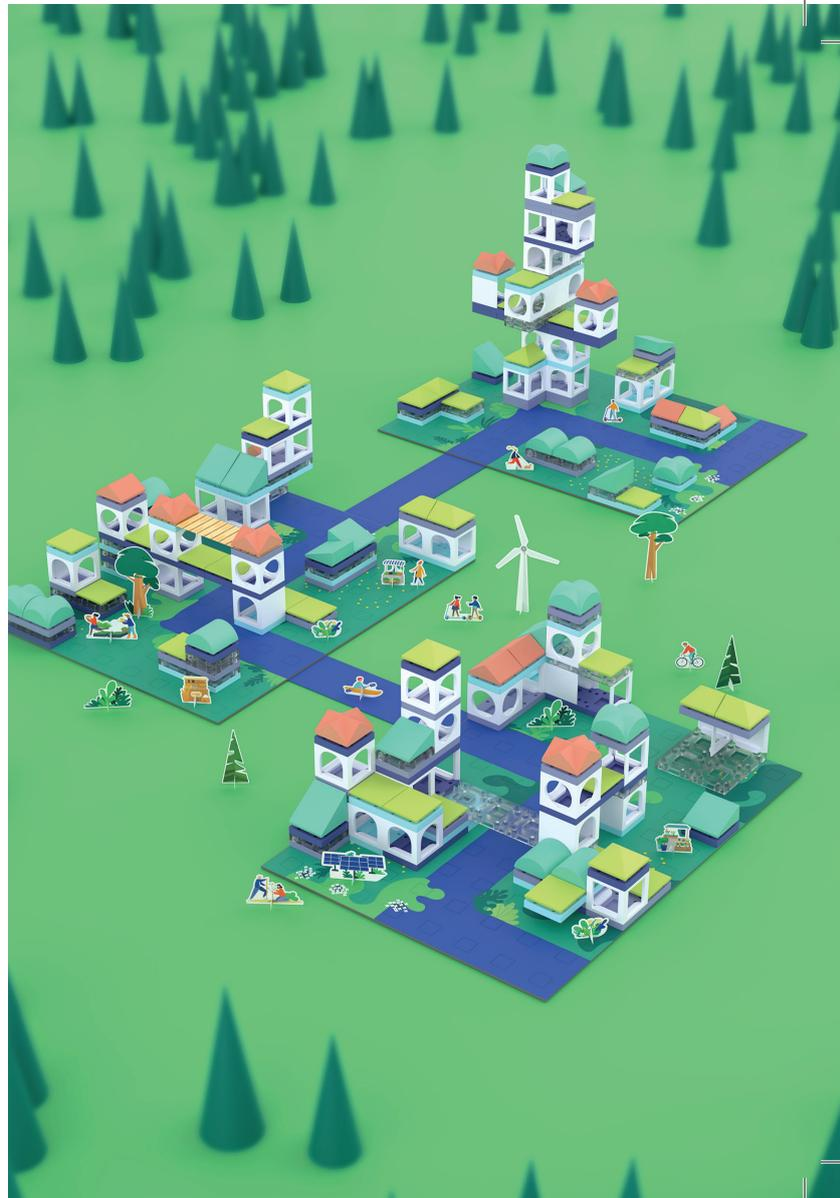

Explore more Arckit sets



Learn about building in interesting environments as well as about sustainable design with Arckit's fun and STEAM educational series of kits. Remember, all Arckit sets are totally 'open-ended' and compatible with one another.

Available at www.arckit.com:



Arckit Greenscape Farm
Explore farm designs



Arckit Coastal Living
Explore coastal house designs



Arckit GO Eco
Explore sustainable architectural designs

Access Arckit Universe

Via www.arckit.com



Arckit 3D Shop

Add unique 3D printed components to your builds from our online 3D Store.



Arckit Education

Access to Arckit Lesson Plans and Workshops. Ideal for schools and homeschooling.

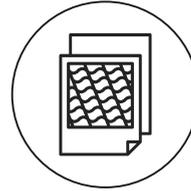

Arckitextures & Assets

Create alternative scenes with Accessories Sets and free printable Arckittexture Library.



Arckit Digital

Build a whole new world online using Arckit through SketchUp platform.



www.arckit.com

f    /arckitmodel