

13.

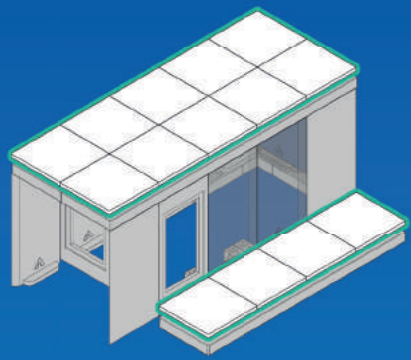

14.

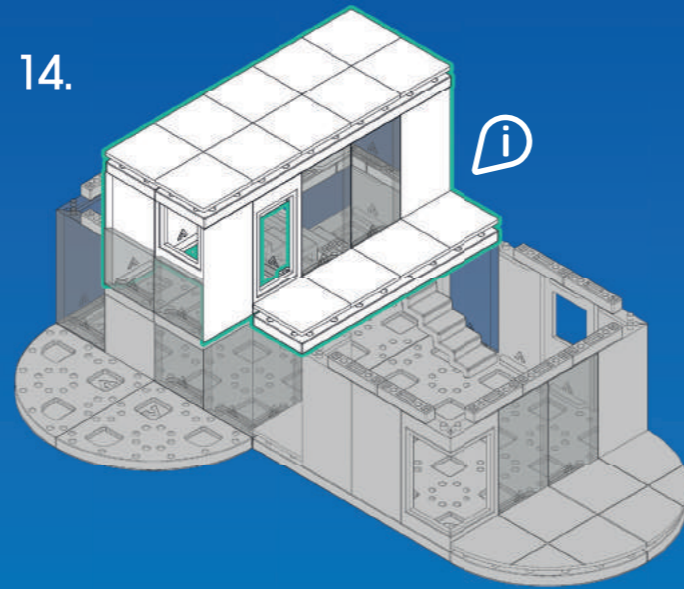

15.

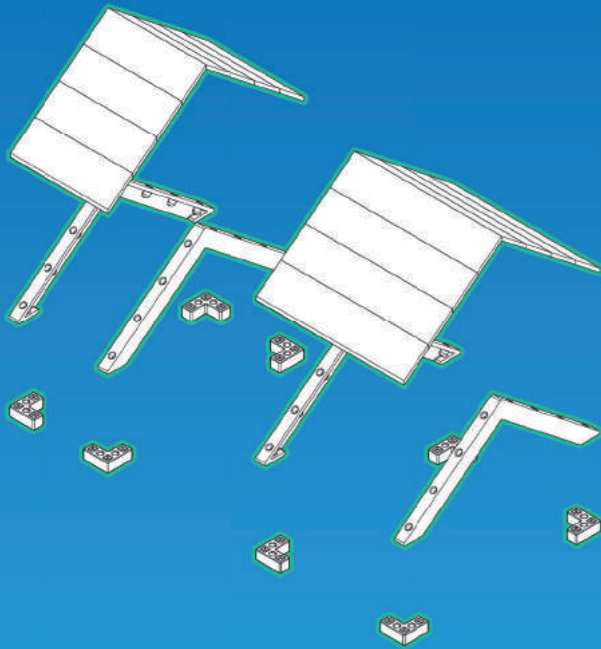

16.

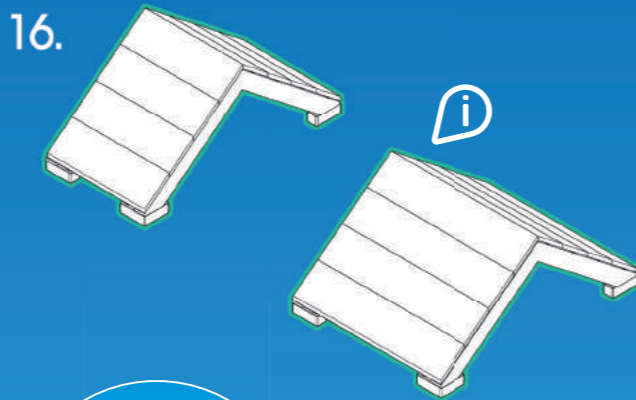

17.

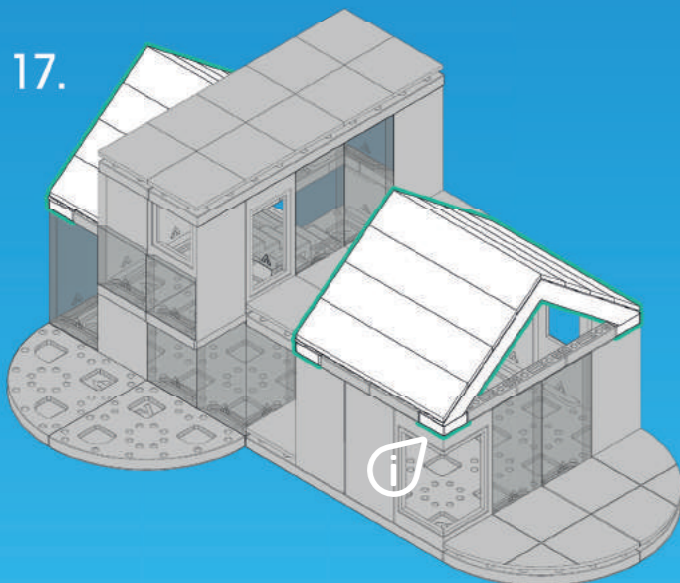

18.

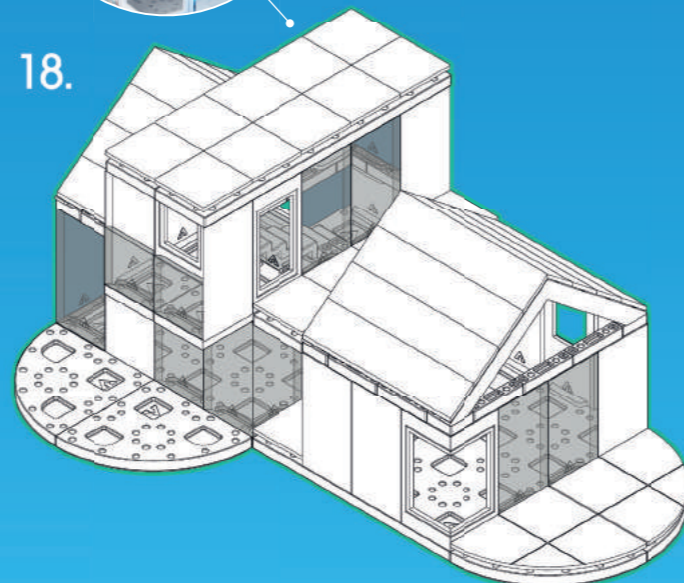

Complete your model using the Arckittexture adhesive sheets supplied.

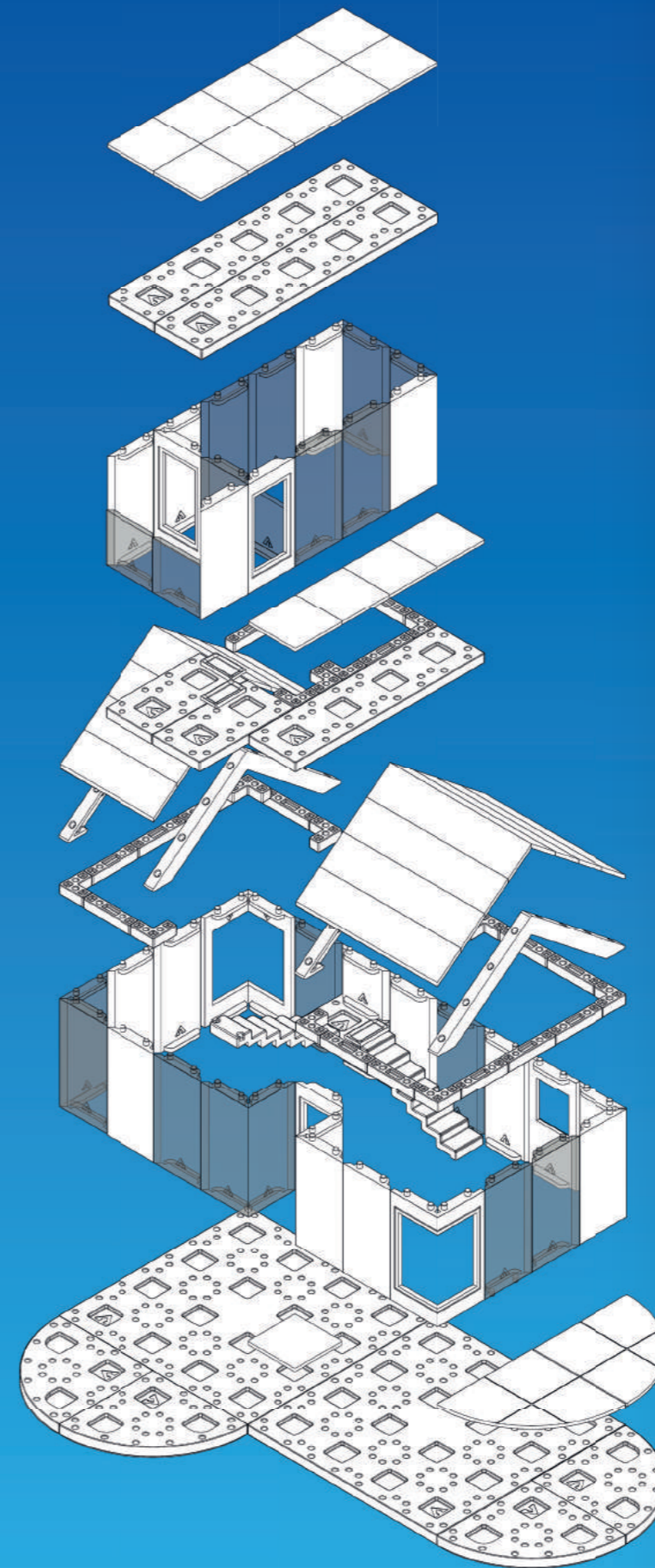

ARCKIT is a multi-award winning architectural modelling system. The reusable freeform components allow budding architects and model enthusiasts to physically explore designs and bring ideas to life faster than ever before.

GO Plus 2.0 now offers even more capabilities with exciting new components and pre-printed adhesive sheets that allow you to complete your models with the realistic building finishes.

It's fast, modular and provides hours of fun!

Arckit is based on modern building techniques and the components are designed to a standard 1.2m/4ft modular grid to scale. Arckit GO Plus 2.0 is compatible with all other Arckit products of the same scale.

Pro tip! For even more fun, why not integrate Arckit GO Plus 2.0 with other Arckit products including our mini series kits and Arckit 90 .

Find exciting interactive 3D construction videos & more building instructions at:

WWW.ARCKIT.COM

or scan the QR code below:



REQUIRES QR CODE SCANNER VIA APP STORE!

@arckitmodel facebook.com/arckit

MADE IN IRELAND

Manufactured by MBM Building Systems Ltd, 17 Clyde Road, Ballsbridge, Dublin 4, Ireland. ©2018 MBM Building Systems Ltd. All rights reserved. Arckit, Arckit Logo, Arckittexture logo and the Arckit Digital logo are trademarks of MBM Building Systems Ltd. Registered in Europe and other countries. Arckit components assembly are patent and design registered internationally.

ARCKIT Project is dedicated to Andrea Murtagh Le grá.

14 - Make sure to align walls before connecting floor panels on top. 16 - When applying the roof panels, make sure to start at the top and that they are facing in the right direction indicated on the back of the panel. 17 - To avoid bending window component, simply use the openings to squeeze and secure in place

Assembly Instructions

01.

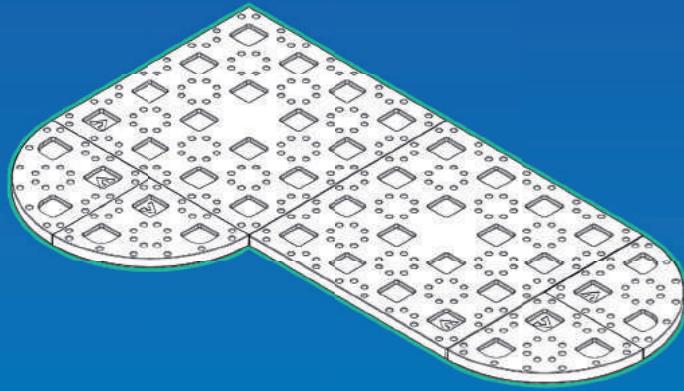

02.

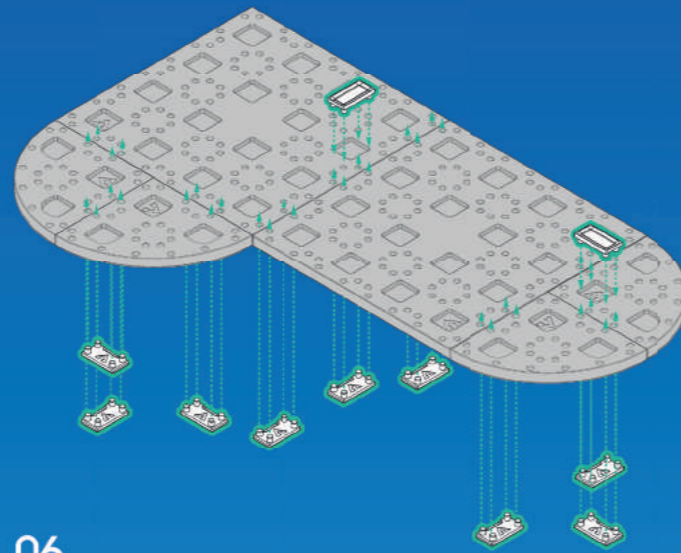

03.

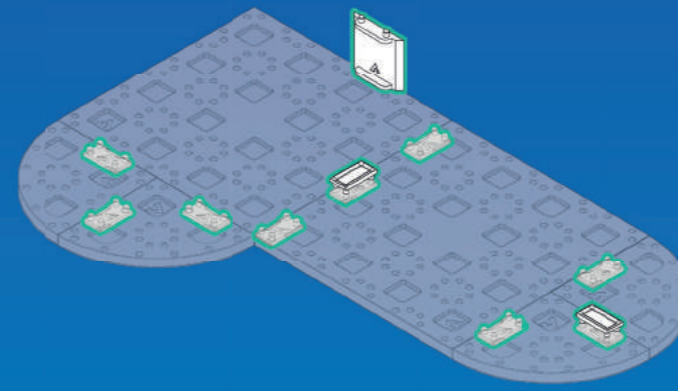

04.

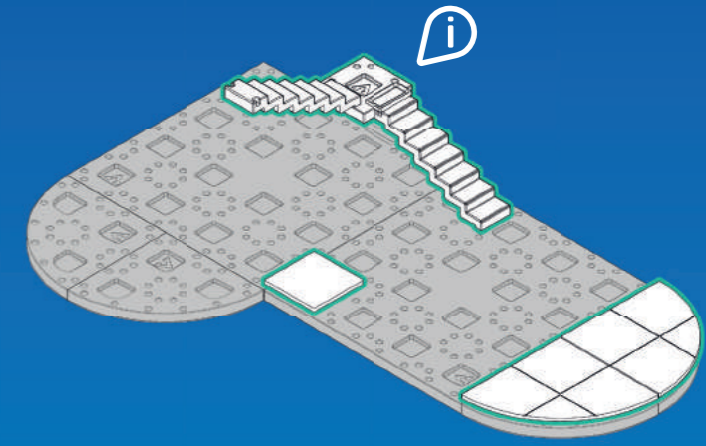

05.

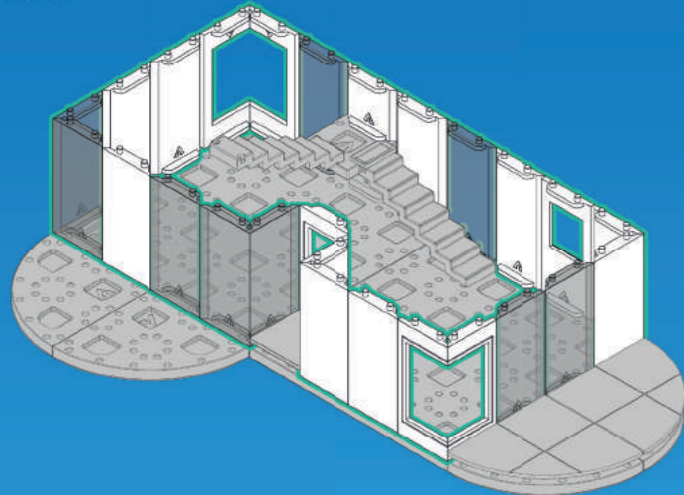

06.

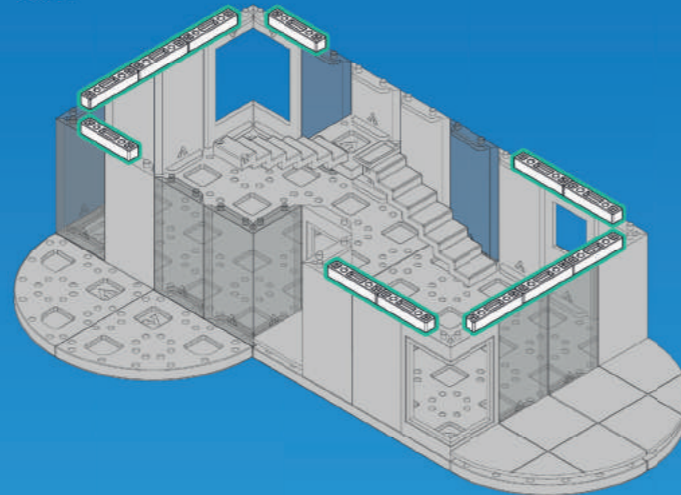

07.

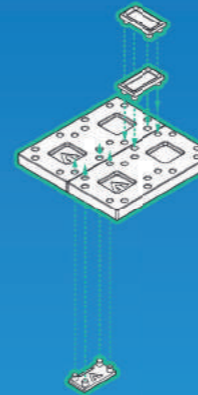

08.

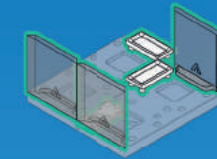

09.

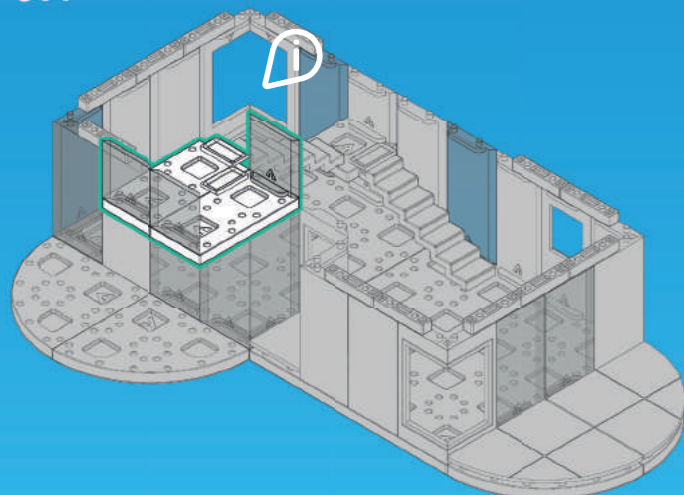

10.

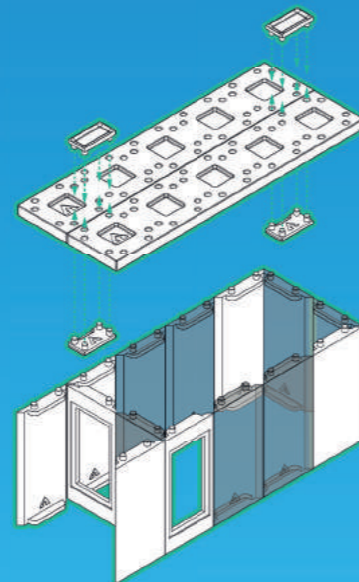

11.

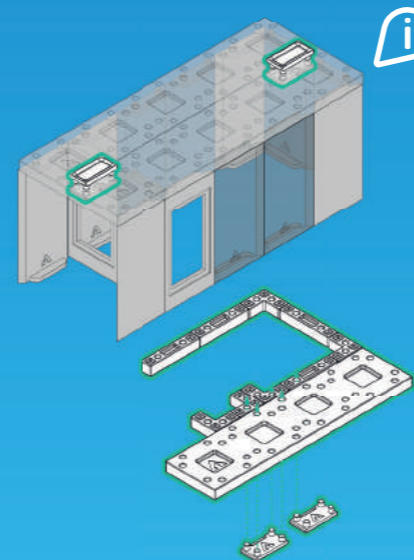

12.

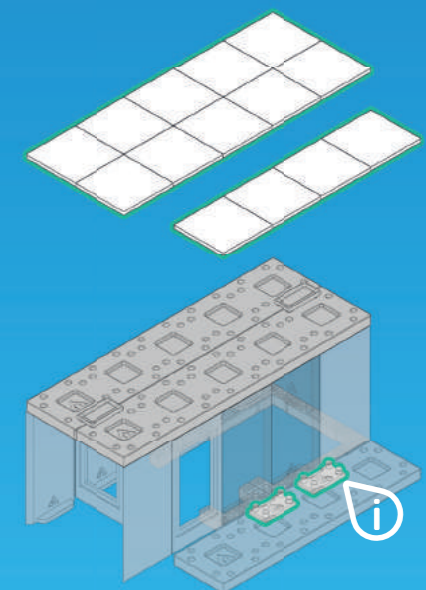

04 - Secure Stair with Link to Floor. 09 - Secure Stair with Link to Floor on upper level. 11 - Make sure to align the walls before heading to the next step. 12 - Insert Links underneath to connect Floor with Wall Joints.