

AF09, AF16 4-pole Contactors up to 30 A AC-1

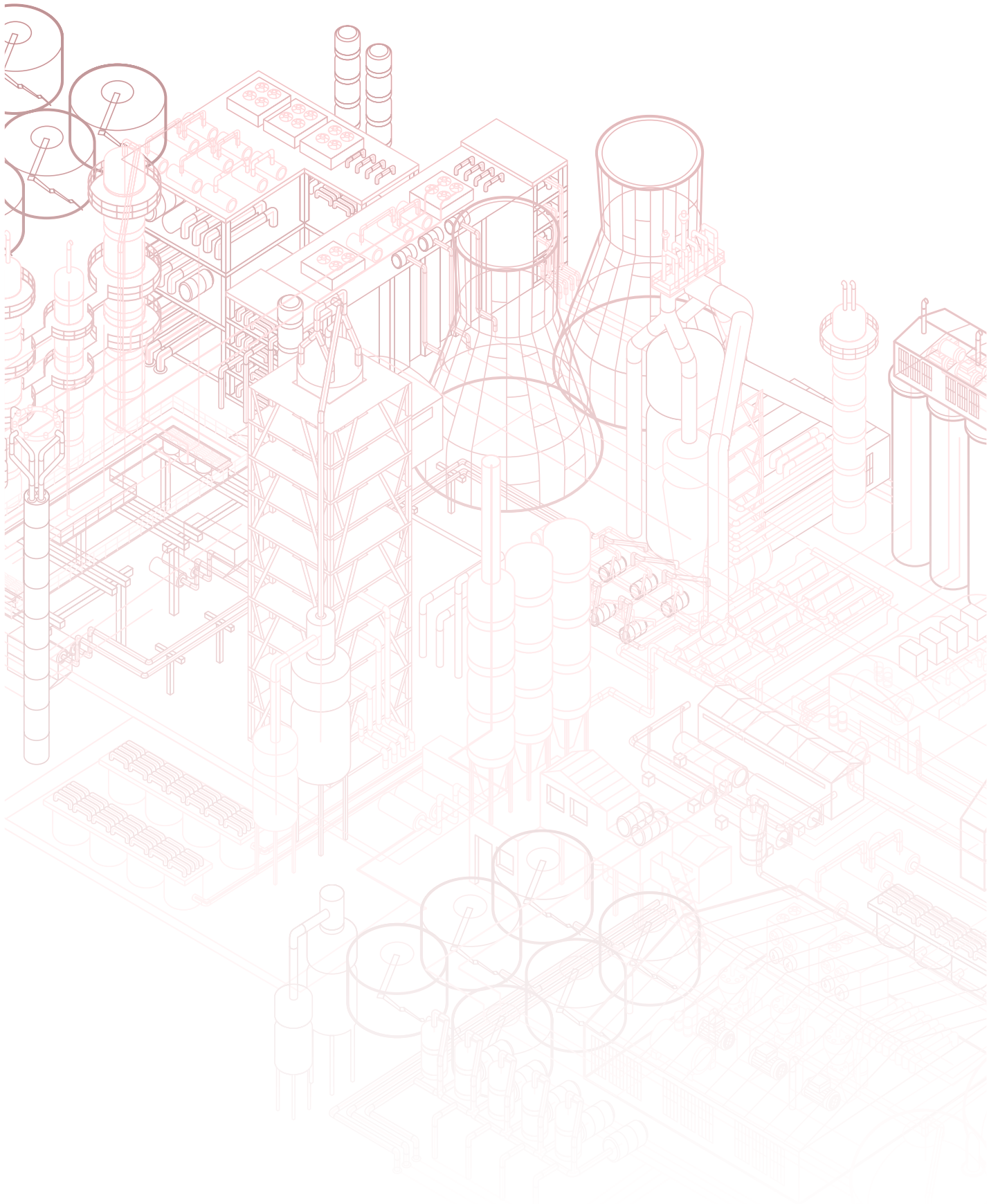

Overview	3
Ordering Details	
– AF09, AF16 4-pole Contactors	4
– AF09Z, AF16Z Additional Coils	5
Technical Data	6
Main Accessory Fitting Details	9
Accessory Ordering Details and Technical Data	10
Terminal Marking and Positioning	15
Dimensions	17





4-pole Contactors



 AC / DC control voltage



AF09	AF16
AF09-40-00	AF16-40-00
AF09-22-00	AF16-22-00

Switching of Resistive Circuits

	IEC	AC-1	Rated	$\theta \leq 40^\circ\text{C}$	690 V
			operational	$\theta \leq 60^\circ\text{C}$	690 V
			current	$\theta \leq 70^\circ\text{C}$	690 V
With conductor cross-sectional area					
	UL/CSA	General use rating		600 V AC	
		With conductor cross-sectional area			

25 A	30 A
25 A	30 A
22 A	26 A
4 mm ²	6 mm ²
25 A	30 A
AWG 10	AWG 10

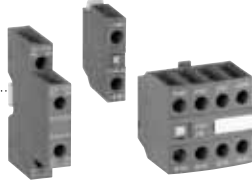
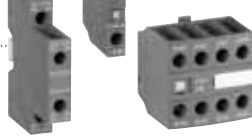
Main Accessories

Auxiliary contact blocks	Front mounting	
	Side mounting	
Interlocks	Mechanical / electrical	
	Mechanical	

1-pole CA4-10 or CA4-01, CC4-10 or CC4-01
4-pole CA4
2-pole CAT4-11 (with coil front connection)
2-pole CAL4-11
VEM4 including VM4 mechanical interlock unit and VE4 electrical interlock block with A2-A2 connection
VM4 including 2 fixing clips

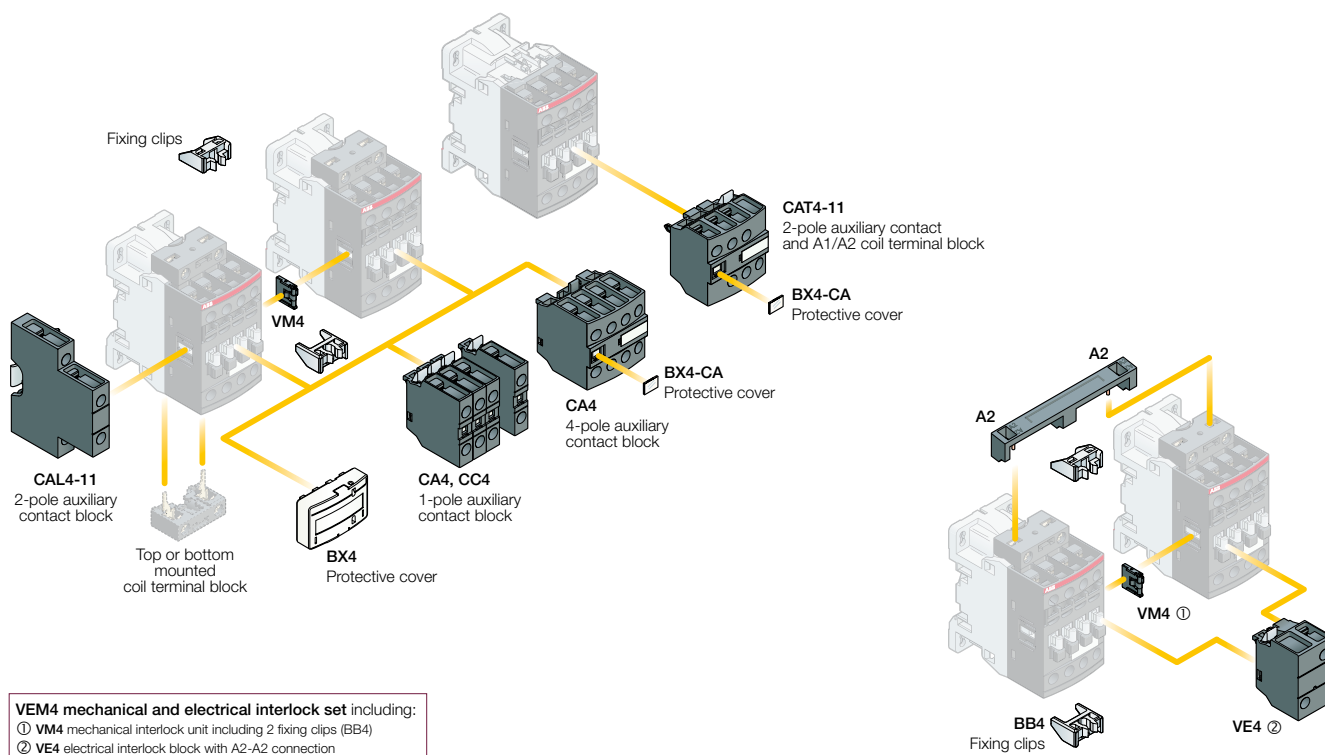

VEM4 mechanical and electrical interlock set including:
 ① VM4 mechanical interlock unit including 2 fixing clips (BB4)
 ② VE4 electrical interlock block with A2-A2 connection

AF09 and AF16 4-pole Contactors

AC / DC Operated - with Screw Terminals



AF09-40-00



AF09-22-00



Application

AF09 and **AF16** 4-pole contactors are used for controlling power circuits up to 690 V AC and 440 V DC. They are mainly used for controlling non-inductive or slightly inductive loads (i.e. resistance furnaces...).

Description

- **AF09** and **AF16** contactors include an electronic coil interface accepting a wide control voltage U_c min. ... U_c max. Only four coils cover control voltages between 24...500 V 50/60 Hz or 20...500 V DC
- **AF** contactors can manage large control voltage variations. One coil (i.e. 100...250 V 50/60 Hz - DC) can be used for different control voltages used worldwide without any coil change
- **AF.Z** contactors equipped with a **Z** coil type allow direct control by 24 V DC 500 mA PLC-output and obtain a reduced holding coil consumption. **AF.Z** contactors withstand short dips and voltage interruptions (SEMI F47-0706 compliance)
- **AF** contactors have built-in surge protection and do not require additional surge suppressors.

Ordering Details

IEC	UL/CSA	Control voltage	Auxiliary contacts fitted	Type	Order code	Weight
AC-1 Rated current $\theta \leq 40^\circ\text{C}$ A	General use rating 600 V AC A	U_c min. ... U_c max. V 50/60 Hz ; V DC	 			Pack ^(ing) 1 piece kg

4 N.O. Main Poles

Rated current (A)	Rated voltage (V)	Control voltage (V)	Auxiliary contacts	Type	Order code	Weight (kg)	
25	25	24...60	20...60	0 0	AF09Z-40-00-21	1SBL 136 201 R2100	0.310
		48...130	48...130	0 0	AF09-40-00-12	1SBL 137 201 R1200	0.270
		100...250	100...250	0 0	AF09-40-00-13	1SBL 137 201 R1300	0.270
		250...500	250...500	0 0	AF09-40-00-14	1SBL 137 201 R1400	0.310
30	30	24...60	20...60	0 0	AF16Z-40-00-21	1SBL 176 201 R2100	0.310
		48...130	48...130	0 0	AF16-40-00-12	1SBL 177 201 R1200	0.270
		100...250	100...250	0 0	AF16-40-00-13	1SBL 177 201 R1300	0.270
		250...500	250...500	0 0	AF16-40-00-14	1SBL 177 201 R1400	0.310

2 N.O. + 2 N.C. Main Poles

Rated current (A)	Rated voltage (V)	Control voltage (V)	Auxiliary contacts	Type	Order code	Weight (kg)	
25	25	24...60	20...60	0 0	AF09Z-22-00-21	1SBL 136 501 R2100	0.310
		48...130	48...130	0 0	AF09-22-00-12	1SBL 137 501 R1200	0.270
		100...250	100...250	0 0	AF09-22-00-13	1SBL 137 501 R1300	0.270
		250...500	250...500	0 0	AF09-22-00-14	1SBL 137 501 R1400	0.310
30	30	24...60	20...60	0 0	AF16Z-22-00-21	1SBL 176 501 R2100	0.310
		48...130	48...130	0 0	AF16-22-00-12	1SBL 177 501 R1200	0.270
		100...250	100...250	0 0	AF16-22-00-13	1SBL 177 501 R1300	0.270
		250...500	250...500	0 0	AF16-22-00-14	1SBL 177 501 R1400	0.310

AF09 and AF16 4-pole Contactors - AF.Z Additional Coils

AC / DC Operated - with Screw Terminals



AF09Z-40-00



AF09Z-22-00

Application

AF09Z and **AF16Z** 4-pole contactors are used for controlling power circuits up to 690 V AC and 440 V DC. They are mainly used for controlling non-inductive or slightly inductive loads (i.e. resistance furnaces...).

Description

- **AF09Z** and **AF16Z** contactors include an electronic coil interface accepting a wide control voltage U_c min. ... U_c max and managing large control voltage variations.
- **AF.Z** contactors cover control voltages between 24...250 V 50/60 Hz or 12...250 V DC
- **AF.Z** contactors allow direct control by PLC-output ≥ 24 V DC 500 mA and obtain a reduced holding coil consumption.
- **AF.Z** contactors withstand short dips and voltage interruptions (SEMI F47-0706 compliance)
- **AF.Z** contactors have built-in surge protection and do not require additional surge suppressors.

Ordering Details

IEC	UL/CSA	Control voltage		Auxiliary contacts fitted	Type	Order code	Weight
AC-1 Rated current	General use rating	U_c min. ... U_c max.					Pack ^(ing)
$\theta \leq 40$ °C	600 VAC	V 50/60 Hz	V DC				1 piece
A	A						kg

4 N.O. Main Poles

IEC	UL/CSA	Control voltage		Auxiliary contacts fitted	Type	Order code	Weight
25	25	-	12...20	0 0	AF09Z-40-00-20	1SBL 136 201 R2000	0.310
		24...60	20...60	0 0	AF09Z-40-00-21	1SBL 136 201 R2100	0.310
		48...130	48...130	0 0	AF09Z-40-00-22	1SBL 136 201 R2200	0.310
		100...250	100...250	0 0	AF09Z-40-00-23	1SBL 136 201 R2300	0.310
30	30	-	12...20	0 0	AF16Z-40-00-20	1SBL 176 201 R2000	0.310
		24...60	20...60	0 0	AF16Z-40-00-21	1SBL 176 201 R2100	0.310
		48...130	48...130	0 0	AF16Z-40-00-22	1SBL 176 201 R2200	0.310
		100...250	100...250	0 0	AF16Z-40-00-23	1SBL 176 201 R2300	0.310

2 N.O. + 2 N.C. Main Poles

IEC	UL/CSA	Control voltage		Auxiliary contacts fitted	Type	Order code	Weight
25	25	-	12...20	0 0	AF09Z-22-00-20	1SBL 136 501 R2000	0.310
		24...60	20...60	0 0	AF09Z-22-00-21	1SBL 136 501 R2100	0.310
		48...130	48...130	0 0	AF09Z-22-00-22	1SBL 136 501 R2200	0.310
		100...250	100...250	0 0	AF09Z-22-00-23	1SBL 136 501 R2300	0.310
30	30	-	12...20	0 0	AF16Z-22-00-20	1SBL 176 501 R2000	0.310
		24...60	20...60	0 0	AF16Z-22-00-21	1SBL 176 501 R2100	0.310
		48...130	48...130	0 0	AF16Z-22-00-22	1SBL 176 501 R2200	0.310
		100...250	100...250	0 0	AF16Z-22-00-23	1SBL 176 501 R2300	0.310

Note: Only AF.Z contactors with DC control voltage 12...20 V DC need to respect the connection polarities indicated close to the coil terminals: A1+ for the positive pole and A2- for the negative pole

AF09 and AF16 4-pole Contactors

Catalogue Page 1SBC 101 109 S0201

Technical Data



Main Pole - Utilization Characteristics according to IEC

Contactor types		AF09	AF16
Standards		IEC 60947-1 / 60947-4-1 and EN 60947-1 / 60947-4-1	
Rated operational voltage U_e max.		690 V	
Rated frequency limits		25 ... 400 Hz	
Conventional free-air thermal current I_{th}		35 A	35 A
acc. to IEC 60947-4-1, open contactors, $\theta \leq 40$ °C			
with conductor cross-sectional area		6 mm ²	6 mm ²
AC-1 Utilization category			
for air temperature close to contactor			
I_e / AC-1 rated operational current	$\theta \leq 40$ °C	25 A	30 A
U_e max. ≤ 690 V, 50/60 Hz	$\theta \leq 60$ °C	25 A	30 A
	$\theta \leq 70$ °C	22 A	26 A
with conductor cross-sectional area		4 mm ²	6 mm ²
Short-circuit protection			
for contactors without thermal O/L relay - Motor protection excluded			
$U_e \leq 500$ V AC - gG type fuse		25 A	32 A
Rated short-time withstand current I_{cw}	1 s	300 A	300 A
at 40 °C ambient temperature, in free air from a cold state	10 s	150 A	150 A
	30 s	80 A	80 A
	1 min	60 A	60 A
	15 min	35 A	35 A
Maximum breaking capacity	at 440 V	250 A	250 A
$\cos \varphi = 0.45$	at 690 V	106 A	106 A
Heat dissipation per pole	I_e / AC-1	0.8 W	1.2 W
Max. electrical switching frequency	AC-1	600 cycles/h	

Main Pole - Utilization Characteristics according to UL / CSA

Contactor types		AF09	AF16
Standards		UL 508, CSA C22.2 N°14	
Rated operational voltage U_e max.		600 V	
UL General use rating			
600 V AC		25 A	30 A
With conductor cross-sectional area		AWG 10	AWG 10
80 V DC - 1-pole for 4 N.O. main poles		25 A	30 A
With conductor cross-sectional area		AWG 10	AWG 10
80 V DC - 1-pole for 2 N.O. / 2 N.C. main poles		20 A	20 A
With conductor cross-sectional area		AWG 12	AWG 12
Max. electrical switching frequency			
for general use		600 cycles/h	

AF09 and AF16 4-pole Contactors

Technical Data



General Technical Data

Contactor types	AF09	AF16
Rated insulation voltage U_i acc. to IEC 60947-4-1	690 V	
acc. to UL / CSA	600 V	
Rated impulse withstand voltage U_{imp}	6 kV	
Electromagnetic compatibility	Devices complying with IEC 60947-1 / EN 60947-1 - Environment A	
Ambient air temperature close to contactor		
Operation in free air	-40 ... +70 °C	
Storage	-60 ... +80 °C	
Climatic withstand	Category B according to IEC 60947-1 Annex Q	
Operating altitude	≤ 3000 m	
Mechanical durability		
Number of operating cycles	10 millions operating cycles	
Max. switching frequency	3600 cycles/h	
Shock withstand acc. IEC 60068-2-27 and EN 60068-2-27		
Mounting position 1		
	Shock direction	1/2 sinusoidal shock for 11 ms: no change in contact position
	A	30 g
	B1	25 g Closed position / 5 g Open position
	B2	15 g
	C1	25 g
	C2	25 g
Vibration withstand acc. to IEC 60068-2-6		
	5 ... 300 Hz 4 g Closed position / 2 g Open position	

Magnet System Characteristics



Contactor types	AF09	AF16
Coil operating limits acc. to IEC 60947-4-1		
	AC supply	at $\theta \leq 60$ °C $0.85 \times U_c$ min ... $1.1 \times U_c$ max at $\theta \leq 70$ °C $0.85 \times U_c$ min ... U_c max
	DC supply	at $\theta \leq 60$ °C $0.85 \times U_c$ min ... $1.1 \times U_c$ max at $\theta \leq 70$ °C (AF) $0.85 \times U_c$ min ... U_c max - (AF.Z) $0.85 \times U_c$ min ... $1.1 \times U_c$ max
AC control voltage 50/60 Hz	Rated control circuit voltage U_c	24 ... 500 V AC
	Coil consumption	Average pull-in value (AF) 50 VA - (AF.Z) 16 VA Average holding value (AF) 2.2 VA / 2 W - (AF.Z) 1.7 VA / 1.5 W
	DC control voltage	Rated control circuit voltage U_c
	Coil consumption	Average pull-in value (AF) 50 W - (AF.Z) 12 ... 16 W Average holding value (AF) 2 W - (AF.Z) 1.7 W
	PLC-Output control	(AF.Z) ≥ 500 mA 24 V DC
Drop-out voltage in % of U_c min.	≤ 60 % U_c min	
Voltage sag immunity according to SEMI F47-0706	(AF.Z) conditions of use on request	
Dips withstand (level 0% according to IEC 61000-4-11) -20 °C ≤ θ ≤ +60 °C	(AF.Z) 22 ms average for $U_c = 24$... 250 V 50/60Hz	
Operating time		
between coil energization and:	N.O. contact closing	40 ... 95 ms
	N.C. contact opening	38 ... 90 ms
between coil de-energization and:	N.O. contact opening	11 ... 95 ms
	N.C. contact closing	13 ... 98 ms

Mounting Characteristics

Contactor types	AF09	AF16
Mounting positions		
Mounting distances	Max. add-on N.C. auxiliary contacts: see accessory fitting details for a 4-pole contactor AF09 or AF16	
Fixing	The contactors can be assembled side by side.	
on rail according to IEC 60715, EN 60715	35 x 7.5 mm or 35 x 15 mm	
by screws (not supplied)	2 x M4 screws placed diagonally	



Connecting Characteristics

Contactor types	AF09	AF16
Main terminals	 Screw terminals with cable clamp	
Connecting capacity (min. ... max.)		
Main conductors (poles)		
 Rigid	solid ($\leq 4 \text{ mm}^2$)	1 x : 1 ... 6 mm ²
 Rigid	stranded ($\geq 6 \text{ mm}^2$)	2 x : 1 ... 6 mm ²
 Flexible with non insulated ferrule		1 x : 0.75 ... 6 mm ²
 Flexible with non insulated ferrule		2 x : 0.75 ... 6 mm ²
 Flexible with insulated ferrule		1 x : 0.75 ... 4 mm ²
 Flexible with insulated ferrule		2 x : 0.75 ... 2.5 mm ²
 Bars or lugs		L < : 9.6 mm
Capacity according to UL/CSA		1 or 2 x : AWG 16 ... 10
Stripping length		: 10 mm
Auxiliary conductors		
 Rigid solid		1 x : 1 ... 2.5 mm ²
 Rigid solid		2 x : 1 ... 2.5 mm ²
 Flexible with non insulated ferrule		1 x : 0.75 ... 2.5 mm ²
 Flexible with non insulated ferrule		2 x : 0.75 ... 2.5 mm ²
 Flexible with insulated ferrule		1 x : 0.75 ... 2.5 mm ²
 Flexible with insulated ferrule		2 x : 0.75 ... 1.5 mm ²
 Bars or lugs		L < : 8 mm
Capacity according to UL/CSA		1 or 2 x : AWG 18 ... 14
Stripping length		: 10 mm
Degree of protection		
acc. to IEC 60947-1 / EN 60947-1 and IEC 60529 / EN 60529		
Main terminals	: IP20	
Coil terminals	: IP20	
Screw terminals		
: (delivered in open position, screws of unused terminals must be tightened)		
Main terminals	: M3.5	
Coil terminals	: M3.5	
Screwdriver type		
: Flat Ø5.5 / Pozidriv 2		
Tightening torque		
Main pole terminals	: 1.5 Nm / 13 lb.in	
Coil terminals	: 1.2 Nm / 11 lb.in	

AF09 and AF16 4-pole Contactors

Main Accessories

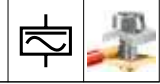

Accessory fitting details for a 4-pole contactor AF09, AF16

Many configurations of accessories are possible depending on whether these are front-mounted or side-mounted.

Contactor types	Main poles	Built-in auxiliary contacts	Front-mounted accessories				Electrical and mechanical interlock set (between 2 contactors)		Side-mounted accessories	
			Auxiliary contact blocks						Auxiliary contact blocks	
			1-pole CA4		2-pole CAT4-11	4-pole CA4	VEM4	Left side	Right side	
			1-pole CC4					2-pole CAL4-11		
Max. add-on N.C. auxiliary contacts: 4 N.C. max. on positions 1, 2, 3, 4 and 3 N.C. max. on positions 1 ±30°, 5										
AF09 ... AF16	4	0	0	0	4 max.	or 1	or 1	-	+ 1	-
AF09 ... AF16	4	0	0	0	2 max.	or 1	-	-	+ 1	+ 1
AF09 ... AF16	4	0	0	0	3 max.	-	-	+ 1	+ 1	or 1
Max. add-on N.C. auxiliary contacts: 3 N.C. max. on positions 1, 2, 3, 4 and 2 N.C. max. on positions 1 ±30°, 5										
AF09 ... AF16	2	2	0	0	4 max.	or 1	or 1	-	+ 1	-
AF09 ... AF16	2	2	0	0	2 max.	or 1	-	-	+ 1	+ 1

Mounting positions

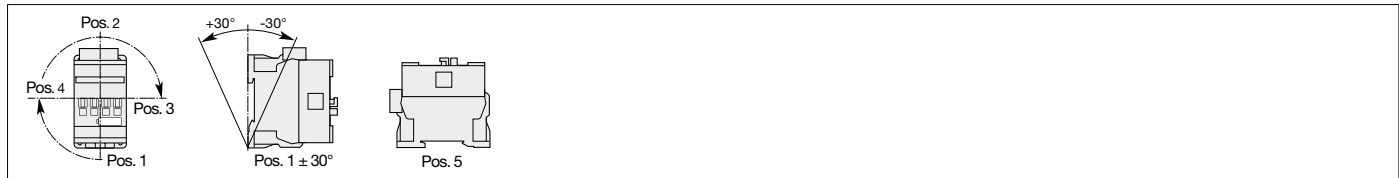

Contactors and main accessories (other accessories available)

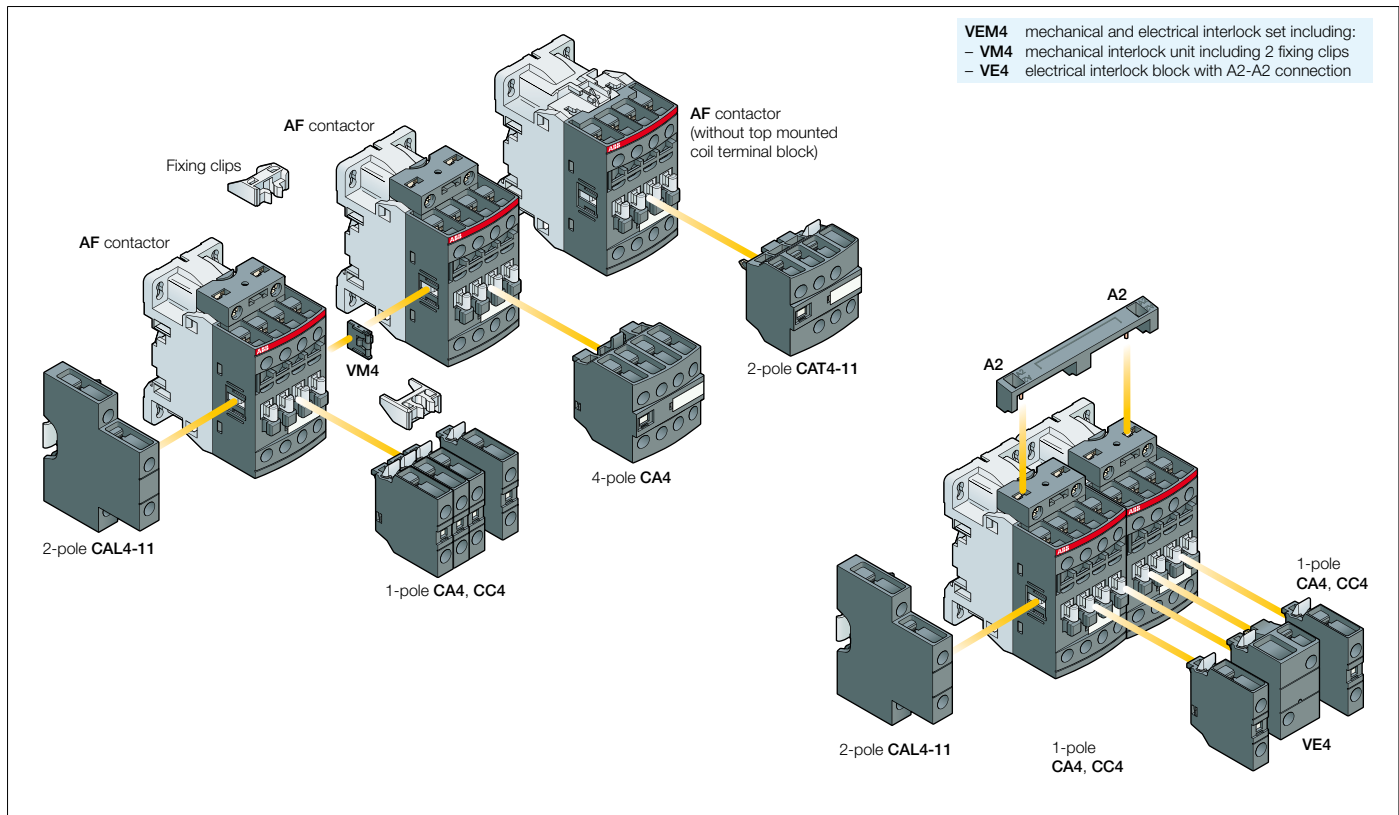



CA4-10



CA4-22E



CAL4-11



CAT4-11E

Application

The auxiliary contact blocks are used for the operation of auxiliary circuits and control circuits.

Description

Types of auxiliary contact blocks for standard industrial environments:

- **CA4** 1 or 4-pole block, front-mounted, instantaneous with N.O., N.C. contacts
- **CC4** 1-pole block, front-mounted, with N.O. leading contact or N.C. lagging contact
- **CAT4** 2-pole block, front-mounted, instantaneous N.O. + N.C. contacts with A1 / A2 coil terminal connection on front face
- **CAL4** 2-pole block instantaneous N.O. + N.C. contacts clipped onto the right and/or left side of the contactors.

The auxiliary contact blocks are equipped with screw type connecting terminals delivered open, protected against accidental direct contact and bear the corresponding function marking.

Fitting Details - For each contactor, refer to "Accessory Fitting Details" table.

Ordering Details

For contactors	Auxiliary contacts	Type	Order code	Pack ^(ing) pieces	Weight kg (1 pce)
	 				

Front-mounted instantaneous auxiliary contact blocks

AF09, AF16..-40-00	1 0 - -	CA4-10	1SBN 010 110 R1010	1	0.014
AF09, AF16..-22-00	1 0 - -	CA4-10-T	1SBN 010 110 T1010	10	0.014
	0 1 - -	CA4-01	1SBN 010 110 R1001	1	0.014
	0 1 - -	CA4-01-T	1SBN 010 110 T1001	10	0.014
	2 2 - -	CA4-22E	1SBN 010 140 R1022	1	0.055
	3 1 - -	CA4-31E	1SBN 010 140 R1031	1	0.055
	4 0 - -	CA4-40E	1SBN 010 140 R1040	1	0.055
AF09, AF16..-40-00	0 4 - -	CA4-04E	1SBN 010 140 R1004	1	0.055

Front-mounted auxiliary contact blocks with N.O. leading contact and N.C. lagging contact

AF09, AF16..-40-00	- - 1 0	CC4-10	1SBN 010 111 R1010	1	0.014
AF09, AF16..-22-00	- - 0 1	CC4-01	1SBN 010 111 R1001	1	0.014

Side-mounted instantaneous auxiliary contact blocks

AF09, AF16..-40-00	1 1 - -	CAL4-11	1SBN 010 120 R1011	1	0.040
AF09, AF16..-22-00	1 1 - -	CAL4-11-T	1SBN 010 120 T1011	10	0.040

Front-mounted instantaneous auxiliary contact and A1/A2 coil terminal blocks

AF09, AF16..-40-00	1 1 - -	CAT4-11E	1SBN 010 151 R1011	1	0.040
AF09, AF16..-22-00					

Note: CAT4 not fittable on AF.Z contactors with DC control voltage 12...20 V DC.

Auxiliary Contact Blocks

Accessories for AF09, AF16 4-pole Contactors



Technical Data

Types	1-pole CA4, 1-pole CC4, 4-pole CA4, 2-pole CAT4, 2-pole CAL4
-------	--

Contact Utilization Characteristics according to IEC

Standards	IEC 60947-5-1 and EN 60947-5-1	
Rated insulation voltage U_i acc. to IEC 60947-5-1	690 V	
Rated impulse withstand voltage U_{imp}	6 kV	
Rated operational voltage U_o max.	24 ... 690 V	
Conventional thermal current $I_{th} - \theta \leq 40^\circ\text{C}$	16 A	
Rated frequency limits	25 ... 400 Hz	
Rated operational current I_o / AC-15 acc. to IEC 60947-5-1	24-127 V 50/60 Hz	6 A
	220-240 V 50/60 Hz	4 A
	400-440 V 50/60 Hz	3 A
	500 V 50/60 Hz	2 A
	690 V 50/60 Hz	2 A
Making capacity acc. to IEC 60947-5-1	10 x I_o AC-15 acc. to IEC 60947-5-1	
Breaking capacity acc. to IEC 60947-5-1	10 x I_o AC-15 acc. to IEC 60947-5-1	
Rated operational current I_o / DC-13 acc. to IEC 60947-5-1	24 V DC	6 A / 144 W
	48 V DC	2.8 A / 134 W
	72 V DC	1 A / 72 W
	110 V DC	0.55 A / 60 W
	125 V DC	0.55 A / 69 W
	220 V DC	0.27 A / 60 W
	250 V DC	0.27 A / 68 W
	400 V DC	0.15 A / 60 W
	500 V DC	0.13 A / 65 W
600 V DC	0.1 A / 60 W	
Short-circuit protection gG type fuse	10 A	
Rated short-time withstand current I_{cw} $\theta = 40^\circ\text{C}$	for 1.0 s	100 A
	for 0.1 s	140 A
Minimum switching capacity with failure rate acc. to IEC 60947-5-4	12 V / 3 mA	
Heat dissipation per pole at 6 A	10^{-7}	
	0.1 W	
Mechanical durability	Number of operating cycles	10 millions operating cycles
	Max. switching frequency	3600 cycles/h
Max. electrical switching frequency	for AC-15	1200 cycles/h
	for DC-13	900 cycles/h

Contact Utilization Characteristics according to UL/CSA

Standards	UL 508, CSA C22.2 N°14
Rated insulation voltage U_i	600 V
Max. rated voltage	600 V AC, 600 V DC
Pilot duty	A600, Q600
AC thermal rated current	10 A
AC maximum volt-ampere making	7200 VA
AC maximum volt-ampere breaking	720 VA
DC thermal rated current	2.5 A
DC maximum volt-ampere making-breaking	69 VA

Connecting Characteristics

Screw terminals	(delivered in open position, screws of unused terminals must be tightened)	
All terminals	M3.5	
Connecting capacity (min. ... max.)		
Rigid solid	1 x	1 ... 2.5 mm ²
Rigid solid	2 x	1 ... 2.5 mm ²
Flexible with non insulated ferrule	1 x	0.75 ... 2.5 mm ²
Flexible with non insulated ferrule	2 x	0.75 ... 2.5 mm ²
Flexible with insulated ferrule	1 x	0.75 ... 2.5 mm ²
Flexible with insulated ferrule	2 x	0.75 ... 1.5 mm ²
Bars or lugs	L <	8 mm
Capacity acc. to UL/CSA	1 or 2 x	AWG 18 ... 14
Stripping length	10 mm	
Degree of protection acc. to IEC 60947-1 / EN 60947-1 and IEC 60529 / EN 60529	IP20	
Screwdriver type	Flat Ø5.5 / Pozidriv 2	
Tightening torque	1.2 Nm / 11 lb.in	

Accessories for AF09, AF16 4-pole Contactors



VM4

Mechanical interlock unit

Description

VM4 mechanical interlock unit for the interlocking of two AF contactors. When mounted between two contactors without additional width, the VM4 mechanical interlock unit prevents one of the contactors from closing as long as the other contactor is closed. The mechanical interlock unit includes 2 fixing clips (BB4).

Ordering Details

For contactors	Type	Order code	Pack ^(ing) pieces	Weight kg (1 pce)
AF09, AF16..-40-00	VM4	1SBN 030 105 T1000	10	0.005

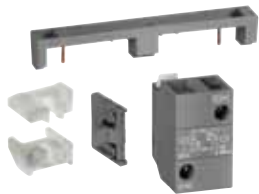

VEM4

Mechanical and electrical interlock set

Description

VEM4 mechanical and electrical interlock set for the interlocking of two AF contactors. **VEM4** set includes a mechanical interlock unit VM4 with 2 fixing clips (BB4) and a VE4 electrical interlock block with A2-A2 connection. Fixing the electrical interlock block to the contactor front face connects the 2 built-in N.C. interlocking contacts with the two coils. VE4 block must be used with A2-A2 connection to respect the electrical connection diagram.

Ordering Details

For contactors	Auxiliary contacts	Type	Order code	Pack ^(ing) pieces	Weight kg (1 pce)
AF09, AF16..-40-00	1 1 	VEM4	1SBN 030 111 R1000	1	0.035

Note: VEM4 not fittable on AF.Z contactors with DC control voltage 12...20 V DC.

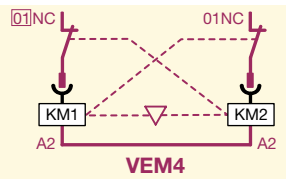

BB4

Fixing clips

Ordering Details

For contactors	Type	Order code	Pack ^(ing) pieces	Weight kg (1 pce)
AF09, AF16..-40-00	BB4	1SBN 110 120 W1000	50	0.002

Accessories for AF09, AF16 4-pole Contactors



Technical Data

Interlock types	VM4
Mechanical durability	
Number of operating cycles	5 millions operating cycles
Max. switching frequency	1800 cycles/h

Interlock types	VEM4
------------------------	-------------





Contact Utilization Characteristics according to IEC

Standards	IEC 60947-5-1 and EN 60947-5-1
Rated insulation voltage U_i acc. to IEC 60947-5-1	690 V
Rated impulse withstand voltage U_{imp}	6 kV
Rated control circuit voltage U_c	AC 50/60 Hz control voltage 24 ... 500 V AC
	DC control voltage 20 ... 500 V DC
Conventional thermal current $I_{th} - \theta \leq 40^\circ\text{C}$	16 A
Mechanical and electrical durability	
Number of operating cycles	5 millions operating cycles
Max. mechanical switching	1800 cycles/h
Max. electrical switching frequency	1200 cycles/h

Contact Utilization Characteristics according to UL / CSA

Standards	UL 508, CSA C22.2 N°14
Max. rated voltage	500 V AC, 500 V DC

Connecting Characteristics

Screw terminals	
All terminals	M3.5
Connecting capacity (min. ... max.)	
 Rigid Solid	1 x 1 ... 2.5 mm ² 2 x 1 ... 2.5 mm ²
 Flexible with non insulated ferrule	1 x 0.75 ... 2.5 mm ² 2 x 0.75 ... 2.5 mm ²
 Flexible with insulated ferrule	1 x 0.75 ... 2.5 mm ² 2 x 0.75 ... 1.5 mm ²
 Bars or lugs	L < 8 mm
Capacity according to UL/CSA	1 or 2 x AWG 18 ... 14
Stripping length	10 mm
Degree of protection	
acc. to IEC 60947-1 / EN 60947-1 and IEC 60529 / EN 60529	IP20
Screwdriver type	Flat Ø5.5 / Pozidriv 2
Tightening torque	1.2 Nm / 11 lb.in

Accessories for AF09, AF16 4-pole Contactors



LDC4

Additional coil terminal block

Description

Additional coil terminal block for a bottom access to the coil terminals of contactors or contactor relays.

Ordering Details

For contactors	Type	Order code	Pack ^(ing) pieces	Weight kg (1 pce)
AF09, AF16	LDC4	1SBN 070 156 T1000	10	0.010



BX4



BX4-CA

Protective covers

Description

Sealable and transparent protective covers BX4 and non-removable BX4-CA to protect the devices against accidental contact.

Ordering Details

For contactors	Type	Order code	Pack ^(ing) pieces	Weight kg (1 pce)
All 1-stack contactors	BX4	1SBN 110 108 T1000	10	0.006
For 4-pole CA4 and 2-pole CAT4 auxiliary contact blocks	BX4-CA	1SBN 110 109 W1000	50	0.001

Function markers

Description

Box of 16 blank cards (16 markers by card) printable on HTP500 thermal transfer printer and AMS 500 marking table to identify your contactors, overload relays or manual motor starters.

Marker dimensions: 7 x 20 mm (.276" x .787")



BA4

Ordering Details

For contactors	Type	Order code	Pack ^(ing) pieces	Weight kg (1 pce)
Marker card	BA4	1SNA 235 156 R2700	16	0.011
AMS 500 support plate for 8 BA4	SPRC 1	1SNA 360 010 R1500	1	0.220
HTP500 support plate	HTP500-BA4	1SNA 235 712 R2400	1	0.290

AF09, AF16 4-pole Contactors

Terminal Marking and Positioning



Standard devices without addition of auxiliary contacts

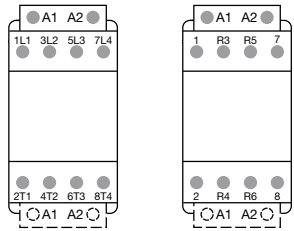

AF09, AF16..-40-00 AF09, AF16..-22-00

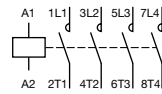

AF09, AF16..-40-00

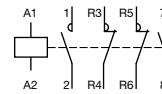

AF09, AF16..-22-00

Other possible contact combinations with auxiliary contacts added by the user

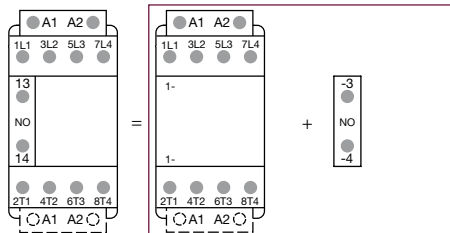

Combination 10 = AF09, AF16..-40-00 + CA4-10

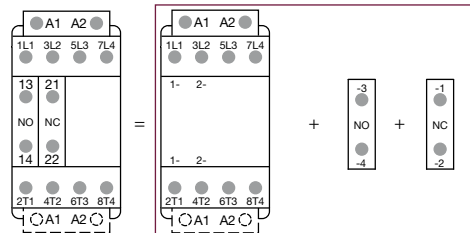

Combination 11 = AF09, AF16..-40-00 + CA4-10 + CA4-01

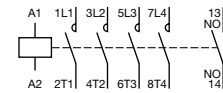

Combination 10

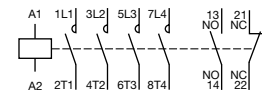

Combination 11

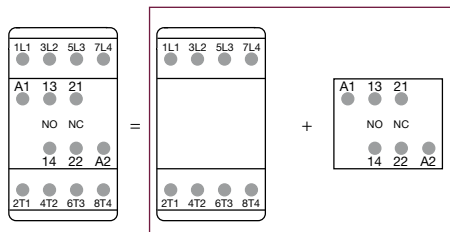

Combination 11 = AF09, AF16..-40-00 + CAT4-11E

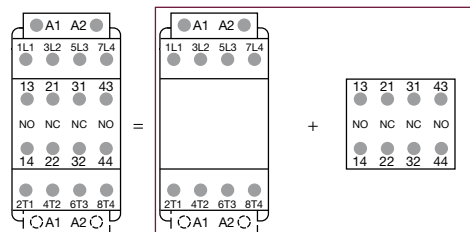

Combination 22 = AF09, AF16..-40-00 + CA4-22E

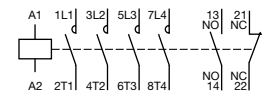

Combination 11

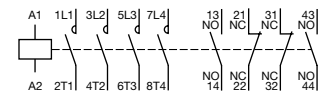

Combination 22

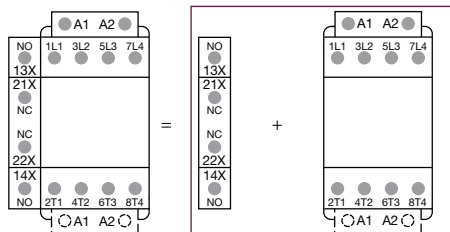

Combination 11 = CAL4-11 + AF09, AF16..-40-00

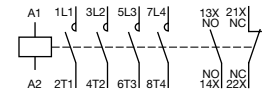

Combination 11

Note: Only AF.Z contactor with DC control voltage 12...20 V DC need to respect the connection polarities indicated close to the coil terminals: A1+ for the positive pole and A2- for the negative pole

Add-on Auxiliary Contacts

Terminal Marking and Positioning



1-pole auxiliary contacts

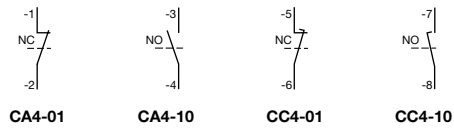

2-pole auxiliary contacts

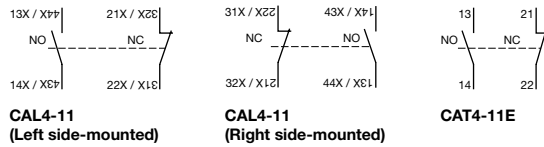

4-pole auxiliary contacts

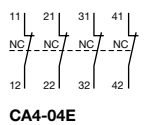
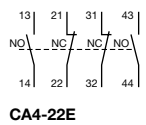
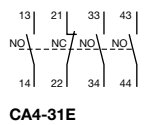
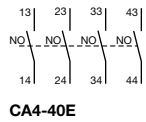

AF09, AF16 4-pole Contactors

AC / DC Operated - with Screw Terminals



Dimensions mm, inches

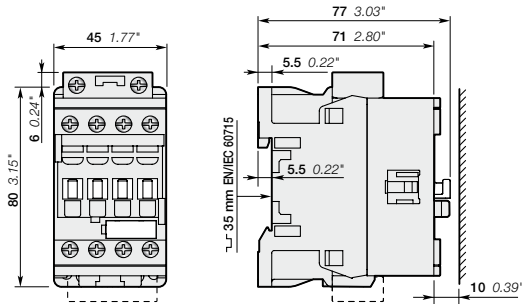

AF09, AF16

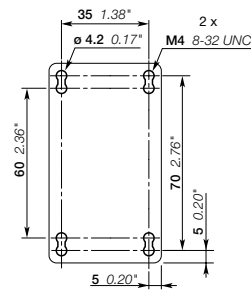

AF09, AF16

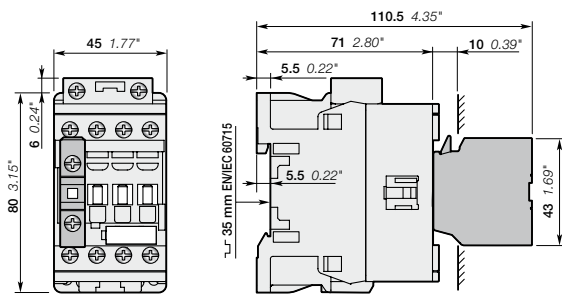

AF09, AF16
+ CA4, CC4 1-pole auxiliary contact block

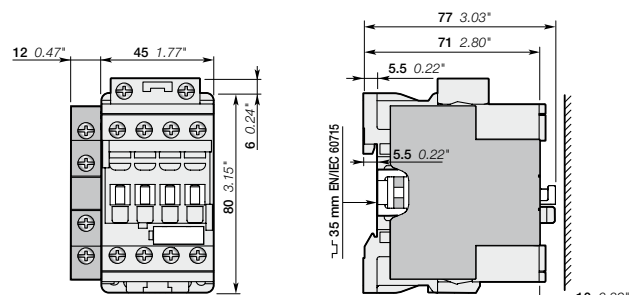

AF09, AF16
+ CAL4-11 2-pole auxiliary contact block

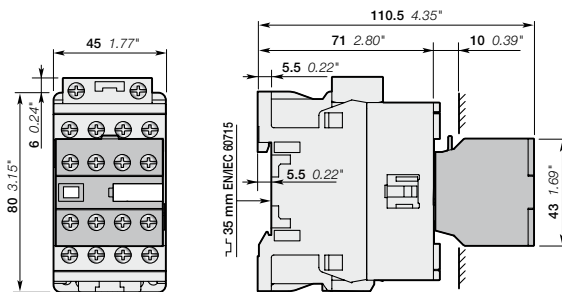

AF09, AF16
+ CA4 4-pole auxiliary contact block

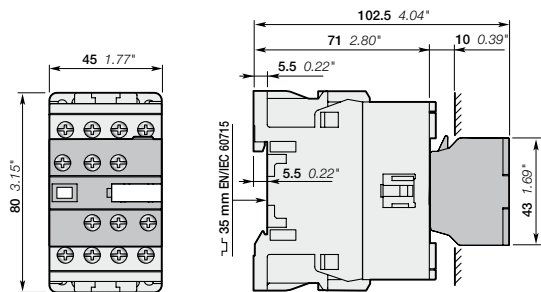

AF09, AF16
+ CAT4 2-pole auxiliary contact and coil terminal block

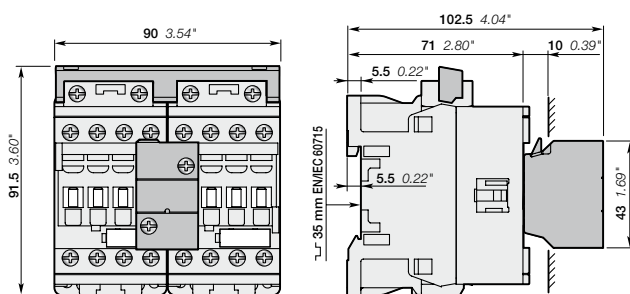

AF09..-40-00, AF16..-40-00
+ VEM4 mechanical and electrical interlock set

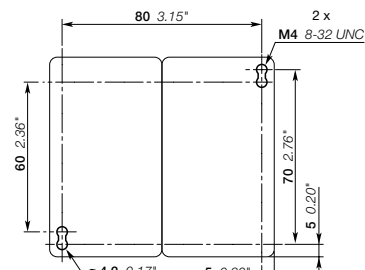

AF09..-40-00, AF16..-40-00
+ VEM4 mechanical and electrical interlock set

Note: contactor lateral distance to grounded component 2 mm 0.08" min.

Contact us

ABB France

Automation Products Division

10, rue Ampère Z.I. - B.P. 114
F-69685 Chassieu cedex / France

ABB STOTZ-KONTAKT GmbH

Eppelheimer Straße 82
D-69123 Heidelberg / Germany

ABB AB/ Cewe-Control

Motorgränd 20
S-721 61 Västerås / Sweden

You can find the address of your local sales organisation
on the ABB home page

<http://www.abb.com/contacts> -> Low Voltage products

Note

We reserve the right to make technical changes or modify the contents of this document without prior notice. With regard to purchase orders, the agreed particulars shall prevail. ABB does not accept any responsibility whatsoever for potential errors or possible lack of information in this document.

We reserve all rights in this document and in the subject matter and illustrations contained therein. Any reproduction, disclosure to third parties or utilization of its contents – in whole or in parts – is forbidden without prior written consent of ABB.

Copyright© 2009 ABB
All rights reserved