



To better help you obtain assistance or service should you ever need it, write down the following information about the product. This information is on the identification label located on the left hand inside wall of the cabinet. We advise you to keep this Owners Manual and sales slip in your possession.

Model: _____

Serial Number: _____

Date of Purchase: _____

Owners Manual

Glass Door Dual Temperature Unit

OPTIONAL



Model: 22-UDGH



30 Armstrong Avenue
Georgetown, Ontario
Canada L7G 4R9

tel: 800.800.5706 or 905.702.1441
fax: 905.702.1442
email: info@minusforty.com
web: minusforty.com



30 Armstrong Ave. Georgetown, Ontario Canada L7G 4R9
tel 800.800.5706 · 905.702.1441 · fax 905.702.1442 · MINUSFORTY.com

⚠ WARNING

IN THE EVENT THE ELECTRONIC SAFETY LOCK HAS LOCKED THE DOOR, THE FOOD IN THE UNIT MUST BE INSPECTED TO INSURE ITS SAFETY AND QUALITY FOR CONSUMPTION.

⚠ WARNING

MAKE SURE THE UNIT IS DISCONNECTED FROM THE POWER SUPPLY BEFORE ANY SERVICE. PRESS THE POWER SWITCH TO THE "OFF" POSITION THEN UNPLUG THE POWER CORD FROM THE ELECTRICAL RECEPTACLE.

ALL SERVICE WORK MUST BE PERFORMED BY CERTIFIED, FACTORY AUTHORIZED SERVICE PERSONNEL ONLY. COMPONENT PARTS MUST BE REPLACED WITH LIKE COMPONENTS.

COMMERCIAL USE ONLY. NOT FOR HOUSEHOLD USE.

FOR INDOOR USE ONLY.

⚠ SAFETY PRECAUTIONS

READ ALL INSTRUCTIONS AND SAVE THESE INSTRUCTIONS FOR FUTURE REFERENCE.

DO NOT STORE OR USE GASOLINE OR OTHER FLAMMABLE VAPORS AND LIQUIDS NEAR THIS OR ANY OTHER APPLIANCE.

DO NOT TOUCH COLD SURFACES WITH DAMP OR WET HANDS. SKIN MAY STICK TO EXTREMELY COLD SURFACES.

DO NOT ALLOW CHILDREN TO CLIMB, HANG OR STAND ON THE UNIT'S SHELVES.

KEEP FINGERS OUT OF PINCH-POINT AREAS.

DISCONNECT POWER TO THE UNIT PRIOR TO CLEANING OR REPAIRING.

BEFORE DISCARDING THIS OR ANY OTHER APPLIANCE, REMOVE THE DOORS OR LIDS TO REDUCE RISK OF CHILD ENTRAPMENT.

WHEN RECYCLING THE UNIT, REFRIGERANTS MUST BE HANDLED IN ACCORDANCE WITH LOCAL AND NATIONAL REGULATIONS.

NOTICE

OPERATING THE FREEZER FOR 24 HOURS PRIOR TO LOADING PRODUCT IS RECOMMENDED

MONITOR FREEZER/REFRIGERATOR TEMPERATURES REGULARLY

ILLUSTRATION

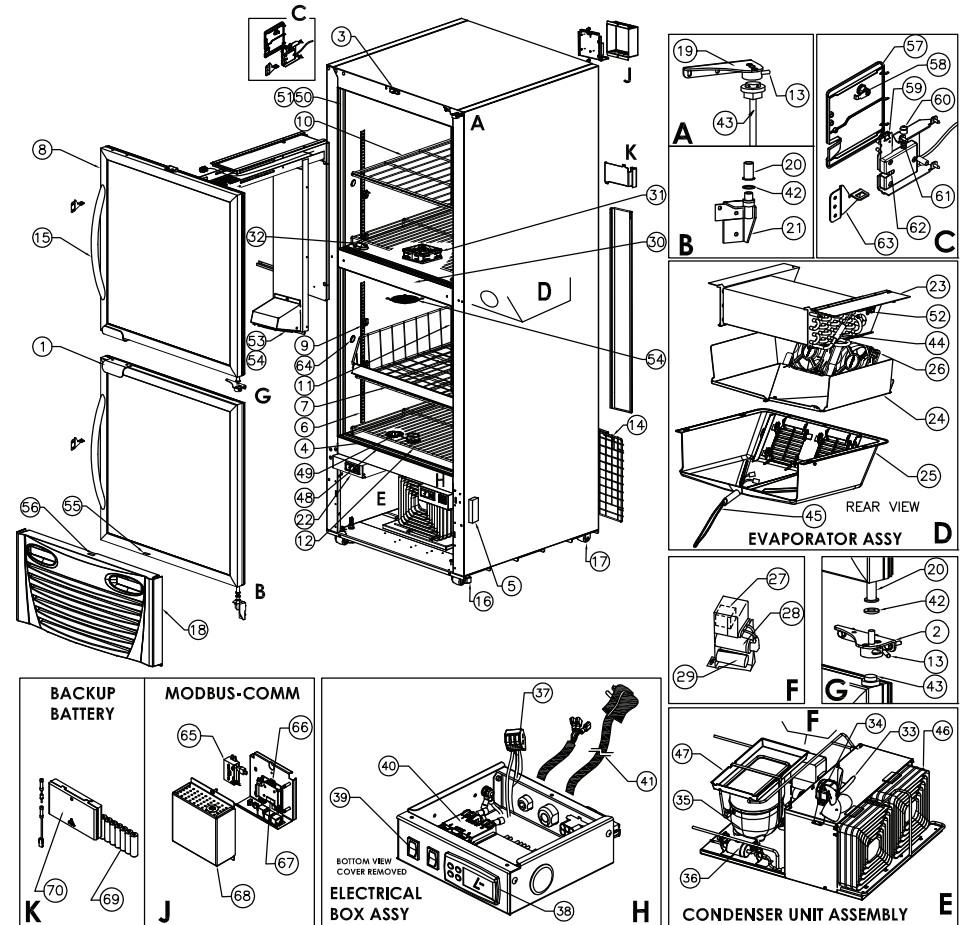

PARTS LIST:

| No | Description | No | Description |
|----|-------------------------------------|----|----------------------------------|
| 1 | Door Handle, Top/Bot Mount | 36 | Filter Drier |
| 2 | Door Bracket (Right or Left) | 37 | 5 Pole Terminal Block |
| 3 | Door Switch | 38 | Controller (Freezer) |
| 4 | Heater Breaker Seal (Bottom/Top) | 39 | Rocker Switch |
| 5 | LED Driver | 40 | Compressor Relay |
| 6 | Pilaster | 41 | Power Cord |
| 7 | Basket | 42 | Nylon Washer |
| 8 | Door Assembly (Right or Left Hand) | 43 | Torsion Bar |
| 9 | Pilaster Clip | 44 | Defrost Heater |
| 10 | Shelf | 45 | Drain Tube Heater |
| 11 | Interior Back Grill | 46 | Condenser Coil |
| 12 | Bottom Shelf | 47 | Condensate Tray Assembly |
| 13 | Torsion Pin | 48 | Cabinet Anti-Condensate Heater |
| 14 | Rear Grill | 49 | Pressure Relief Ball |
| 15 | Door Handle | 50 | Heater Breaker Seal (LED) |
| 16 | Leveling Leg | 51 | Cabinet LED Strip |
| 17 | Caster | 52 | Thermostat, Defrost Limit |
| 18 | Front Bottom Grill | 53 | Recirculation Fan |
| 19 | Door Top Bracket (Right or Left) | 54 | Fan Guard |
| 20 | Bushing, Nylon | 55 | Magnetic Door Switch |
| 21 | Door Bottom Bracket (Right or Left) | 56 | Magnetic Door Switch Actuator |
| 22 | Controller (Refrigerator) | 57 | Lock Cover (Optional) |
| 23 | Evaporator Coil | 58 | Camlock (Optional) |
| 24 | Evaporator Tray | 59 | Lock LSIB (Optional) |
| 25 | Evaporator Shroud | 60 | Lock Release Pin (Optional) |
| 26 | Evaporator Fan | 61 | Lock Release Spring (Optional) |
| 27 | Relay Potential | 62 | Lock (Optional) |
| 28 | Run Capacitor | 63 | Lock Latch (Optional) |
| 29 | Start Capacitor | 64 | Lock Pushbutton (Optional) |
| 30 | Divider | 65 | 12-5 VDC Converter (Optional) |
| 31 | Divider Fan | 66 | Raspberry-Pi (Optional) |
| 32 | Divider Louver | 67 | RS-485 Shield (Optional) |
| 33 | Fan Blade (Condensing Unit) | 68 | Housing, Connectivity (Optional) |
| 34 | Fan Motor (Condensing Unit) | 69 | Backup Battery (Optional) |
| 35 | Compressor | 70 | Battery Holder (Optional) |

CAUTIONARY INSTRUCTIONS FOR UNITS CHARGED WITH PROPANE (R290) REFRIGERANT

⚠ WARNING



THIS UNIT IS CHARGED WITH PROPANE REFRIGERANT. PROPANE IS AN EXTREMELY FLAMMABLE AND EXPLOSIVE GAS. PLEASE READ CAREFULLY THIS MANUAL/GUIDE AND FOLLOW ALL SAFETY PRECAUTIONS CONTAINED HEREIN TO REDUCE A RISK OF FIRE AND/OR EXPLOSION. FAILURE TO FOLLOW THE SAFETY PRECAUTIONS MAY RESULT IN SERIOUS INJURY OR DEATH, AND/OR PROPERTY DAMAGE.

- **DANGER - RISK OF FIRE OR EXPLOSION. FLAMMABLE REFRIGERANT USED. DO NOT USE MECHANICAL DEVICES TO DEFROST REFRIGERATOR. DO NOT PUNCTURE REFRIGERANT TUBING.**
- **DANGER - RISK OF FIRE OR EXPLOSION. FLAMMABLE REFRIGERANT USED. TO BE REPAIRED ONLY BY FACTORY AUTHORIZED TRAINED SERVICE PERSONNEL. DO NOT PUNCTURE REFRIGERANT TUBING.**
- **CAUTION - RISK OF FIRE OR EXPLOSION. FLAMMABLE REFRIGERANT USED. CONSULT REPAIR MANUAL/OWNER'S GUIDE BEFORE ATTEMPTING TO SERVICE THIS PRODUCT. ALL SAFETY PRECAUTIONS MUST BE FOLLOWED.**
- **CAUTION - RISK OF FIRE OR EXPLOSION. DISPOSE OF PROPERLY IN ACCORDANCE WITH FEDERAL OR LOCAL REGULATIONS. FLAMMABLE REFRIGERANT USED.**
- **CAUTION - RISK OF FIRE OR EXPLOSION DUE TO PUNCTURE OF REFRIGERANT TUBING; FOLLOW HANDLING INSTRUCTIONS CAREFULLY. FLAMMABLE REFRIGERANT USED.**

Propane is approved for use as a refrigerant in commercial, self-contained units in Canada and USA under limited use conditions. It can be used in new equipment only, retrofitting is not allowed, with a limited charge of up to 150 grams (5.3 oz) per refrigeration circuit. Even though this is a small amount, it still presents a fire/explosion hazard if it leaks out of refrigerant containing parts. When mixed with air, a flammable propane-air mixture can be created and easily ignited by sparks, open flames, or hot surfaces. This is particularly true in confined zones. Propane is heavier than air and tends to settle at lower points.

To mitigate the risk, please follow the precautionary measures as follows:

- Avoid unit installation in areas with open flames (kitchens, repair garages or the like), or in vicinity of open flames or high surface temperatures.
- Avoid unit installation in confined spaces. Well ventilated areas are preferred. Keep clear all ventilation openings of obstructions.
- Do not rely on smell to detect potential leaks of propane refrigerant. Propane refrigerant is a high purity propane gas and does not contain any stenching agent(s). Stenching agents are typically used in fuel-grade propane and natural gas to detect their presence in air by relying on smell.
- All repairs must be performed in well ventilated areas.
- To minimize the risk of possible ignition due to incorrect parts or improper service, component parts shall be replaced with like components and servicing shall be done by service personnel authorized by Minus Forty Technologies Corp.
- Do not attempt to modify the unit or remove any functional part(s) from the unit.
- Handle the unit with care to avoid any damage.
- When transporting the unit, all appropriate safety measures must be considered. Check with local Department of Transportation for detailed requirements pertaining to transportation of flammable gasses.

CONTENTS

| | |
|---------------------------------------------|---------|
| Warranty | 1 |
| Installation Instructions | 2 |
| Shelf and Basket, Placement and Adjustment | 3 |
| Operating Instructions | 3 |
| Product Loading | 4 |
| Temperature Adjustment and Switch Functions | 5 |
| Controller Alarms and Signals | 6 - 7 |
| Controller Symbols and Functions | 7 - 8 |
| Electronic Food Safety Lock | 9 - 13 |
| General Description | 9 - 10 |
| Unit Locking Operation | 10 - 11 |
| Backup Battery (UPS) Operation | 11 |
| Entrapment Lock Release | 12 |
| Restocking Delay | 12 |
| Accessing / Resetting Alarm Data | 12 - 13 |
| Field Testing | 13 |
| Manual Defrost | 14 |
| How to Remove the Front Bottom Grill | 14 |
| Condenser Cleaning | 15 |
| Cabinet Cleaning | 15 - 16 |
| Interior LED Strip Replacement | 17 |
| Troubleshooting Guide | 18 - 19 |
| Wiring Diagrams | 20 - 21 |
| Parts Listing | 22 |
| Parts Illustration | 23 |

WIRING DIAGRAM (MODELS WITHOUT ELECTRONIC LOCK)

DWG#: 8388-AA-02

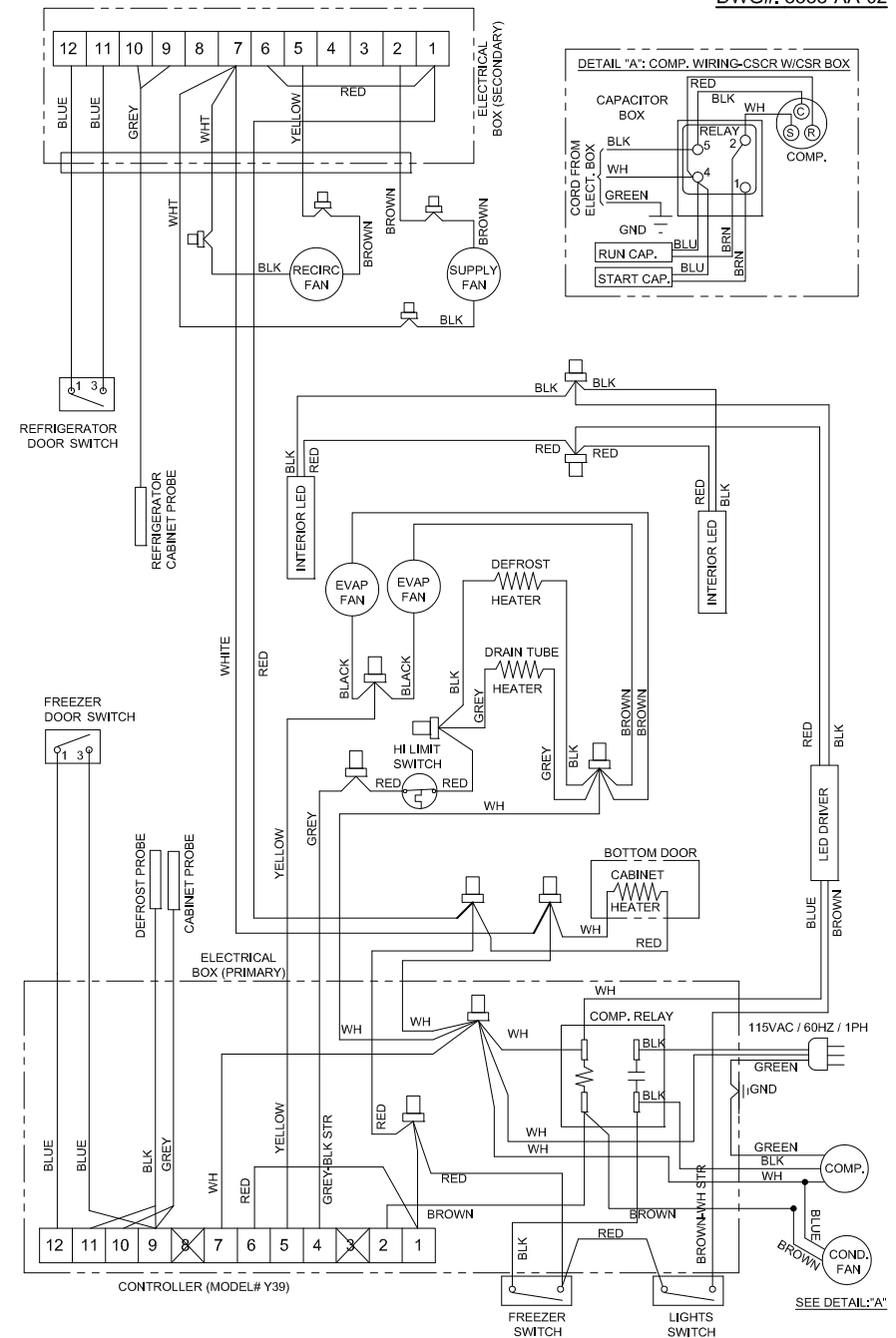

WIRING DIAGRAM (MODELS WITH ELECTRONIC LOCK)

DWG#: 8049-AA-03

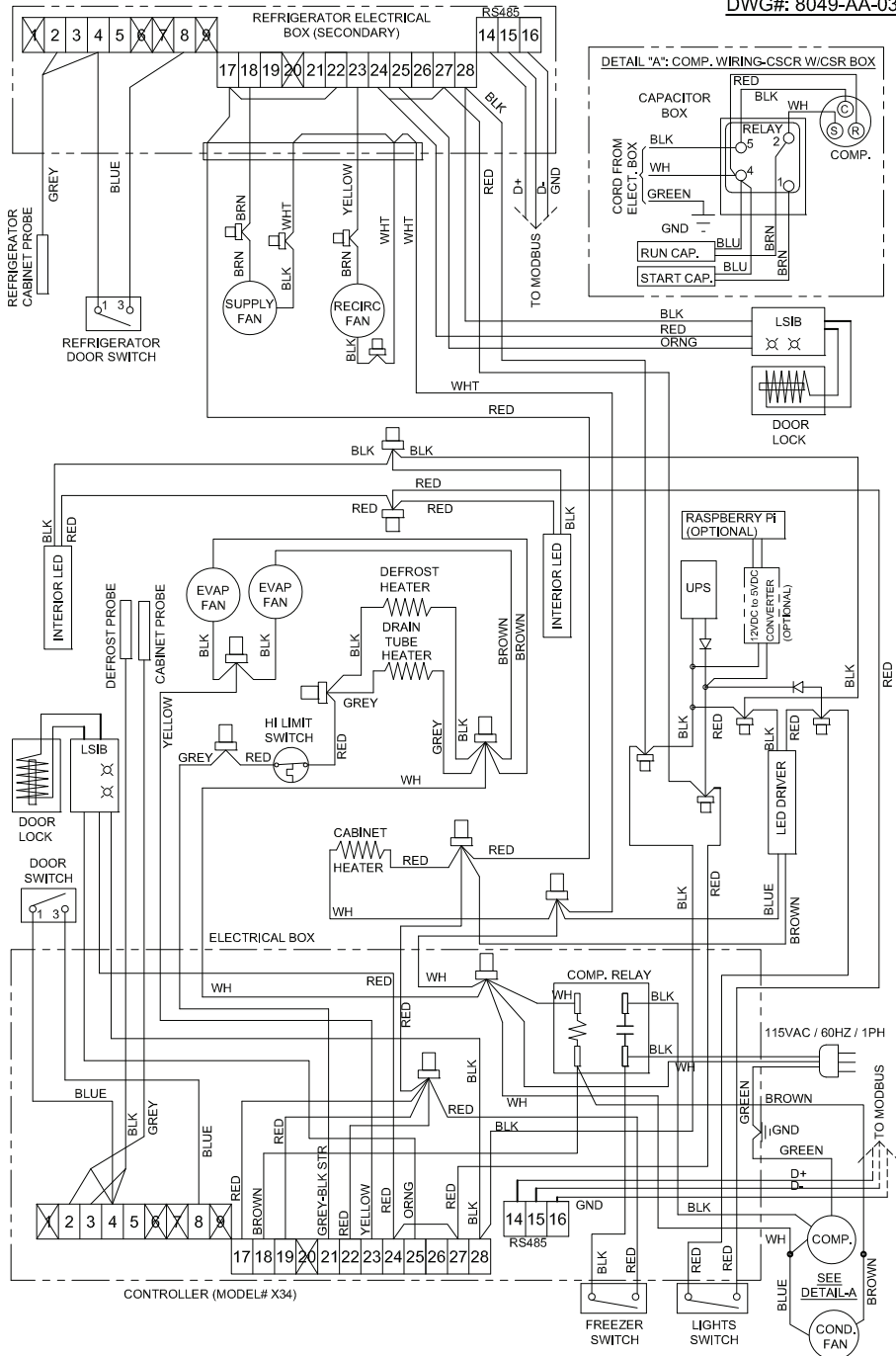

STANDARD WARRANTY FOR MINUS FORTY® REFRIGERATION EQUIPMENT AND ACCESSORIES

LIMITED WARRANTY

Minus Forty® Technologies Corp. warrants its products to be free from defect as to workmanship and materials for a period of twelve (12) months from the time of delivery.

Minus Forty® Technologies Corp. will at its option either replace or repair any defective parts returned within twelve (12) months of the time of delivery, transportation charges prepaid, which Minus Forty® Technologies Corp. in its sole discretion, determines to be defective.

This warranty shall not apply to any products that have been repaired or altered outside of Minus Forty® Technologies Corp.'s factory or repair facilities if the repairs in the judgement of Minus Forty® Technologies Corp. have affected the reliability or wear of the product and nor does the guarantee apply to any product which has been subject to misuse, accident or to any product which has not been maintained pursuant to the instruction of Minus Forty® Technologies Corp.

This warranty does not extend to any consequential damage caused by the failure of the product under any circumstance and further, Minus Forty® Technologies Corp. shall not be responsible for damage to the contents of the product or any economic loss caused by the failure of the product, whether such loss is suffered by the customer or a third party user of the product or whether the contents are owned by the customer or a third party user or supplier.



Effective January 1, 1996

INSTALLATION INSTRUCTIONS

⚠ WARNING

The unit **MUST** be installed on a dedicated grounded circuit protected with a 15 Amp circuit breaker or 15 Amp time delay fuse. Do not remove ground prong. If the cord or plug is damaged, replace with the same type. Refrigeration and electrical work must be performed by a qualified technician. Failure to follow these instructions can result in injury, death, fire, or electrical shock.

POWER REQUIREMENTS: These models require a 15 Amp dedicated and properly grounded 115V/60Hz/1Ph circuit with a NEMA 5-15P receptacle. Wiring should be sized according to the amperage rating stated on the serial plate. Failure to use a dedicated circuit may cause the circuit breaker to trip off and/or cause voltage drops. As a result, power to the unit may be interrupted and cooling performance can be adversely affected which may cause equipment damage and/or product loss.

Voltage supply to the unit must not vary more than $\pm 10\%$ of the nominal 115V, or performance may be affected. The warranty and liability does not cover damage resulting from excessive voltage variations.

- **DO NOT USE AN EXTENSION CORD**
- **DO NOT CUT, REMOVE OR BYPASS THE GROUNDING PRONG FROM THE PLUG**
- **DO NOT PLUG UNIT INTO AN OUTLET CONTROLLED BY A WALL SWITCH**
- **ENSURE POWER CORD IS NOT CUT OR DAMAGED FROM PINCHING, KNOTTING, OR MISHANDLING**

CABINET LOCATION: An air space of at least 6" (15 cm) must be maintained on all sides of the unit. Do not locate the unit in a warm unventilated room exceeding 86°F (30°C), 55% RH; do not place unit in direct sunlight; do not place unit under or near heat range or heating vent.

CABINET LEVELING: The unit must be completely leveled side to side and front to back or slightly tilted front to back but never tilted forward. Once the unit is placed in its final location, use a carpenter level to level the unit. Proper leveling of the unit is important for the door closing and water drainage during the defrost cycle. There are two leg levelers in the front that can be adjusted. First, loosen the nuts using an adjustable wrench. Second, turn levelers counter-clockwise to raise the unit, or clockwise to lower, until they reach the leveled position. Lastly, tighten the nuts again to lock the legs.

NOTICE:

Failure to follow these instructions may void the warranty and/or cause loss of product.

PROTECTIVE DOOR FILM

The anti-fog glass door has a protective film on the inner side. After the unit has been installed, peel and remove the protective film covering the inner glass surface.



NEMA 5-15P

TROUBLESHOOTING GUIDE (CONT'D)

for online reference go to minusforty.com

⚠ WARNING

Make sure the unit is disconnected from the power supply before any service. Press the power switch to the "Off" position then unplug the power cord from electrical receptacle. All service work must be conducted by a certified technician only.

| Problem | Possible Cause | Action |
|-------------------------------------------------------------------------|------------------------------------------------------------------------------------------------------------------------------------------------------------------------------|---------------------------------------------------------------------------------------------------------------------------------------------------------------------------------------------------------------------------------------------------|
| Condensation on glass door. | <ul style="list-style-type: none"> • Door not closing properly. • Room humidity too high. | <ul style="list-style-type: none"> • Check the spring tension or any obstruction • To prevent condensation, room humidity should be below 55%. |
| LED strips are not working. | <ul style="list-style-type: none"> • Light switch is off. • Faulty LED strip. | <ul style="list-style-type: none"> • Check if the light switch is on. • Replace the LED strip. (See page 17) |
| Cabinet is noisy. | <ul style="list-style-type: none"> • Part(s) loose • Tubing vibrating | <ul style="list-style-type: none"> • Locate and tighten loose part(s). • Ensure tubing is not in contact with other tubing or components. |
| Door does not close tight. | <ul style="list-style-type: none"> • Unit is not leveled. • Hinges are loose / not adjusted. • Gasket is out of the groove. | <ul style="list-style-type: none"> • Level the unit (See page 2). • Adjust / tighten the hinge screws. • Check gasket condition. Adjust position or replace gasket. |
| Electronic control blank, flashing, or displaying incorrect characters. | <ul style="list-style-type: none"> • Wires disconnected at back of electronic control. | <ul style="list-style-type: none"> • See actions described on the controller section. (page 6) |
| Evaporator fan does not run. | <ul style="list-style-type: none"> • Fan wire disconnected. • Door switch not working. • Defrost probe not attached to the evaporator coil. | <ul style="list-style-type: none"> • Check wiring. • Check door switch. • Check the location of defrost probe. It should be pressed in between fins in the middle of the evaporator and close to the cabinet top |

TROUBLESHOOTING GUIDE

for online reference go to minusforty.com

⚠ WARNING

Make sure the unit is disconnected from the power supply before any service. Press the power switch to the "Off" position then unplug the power cord from electrical receptacle. All service work must be conducted by a certified technician only.

| Problem | Possible Cause | Action |
|------------------------------------------------------------------|-----------------------------------------------------------------------------------------------------------------------------------------------------------------------------------------------------------------------------------------------------------------------------------------|--------------------------------------------------------------------------------------------------------------------------------------------------------------------------------------------------------------------------------------------------------------------------------------------------------------------------------------------------------------------------------------------------------------|
| Freezer not operating. | <ul style="list-style-type: none"> Power switch located on the front grill turned off. Fuse blown / circuit breaker tripped. Power cord unplugged. Receptacle not working. Improper voltage supplied to cabinet / over load circuit. | <ul style="list-style-type: none"> Turn power switch on. Replace fuse/reset circuit breaker. Plug in power cord. Check receptacle. Remove extension cords or other equipment on the same circuit. |
| Freezer not getting cold but compressor is running | <ul style="list-style-type: none"> Unit located in direct sunlight or ambient (room) temperature is too hot. Condenser clogged with dust. | <ul style="list-style-type: none"> Move unit away from direct sunlight. Room temperature is recommended not to exceed 86°F (30°C), 55% RH. See page 15 (Cleaning) |
| Condensing unit operates for a prolonged period or continuously. | <ul style="list-style-type: none"> Unit loaded with excessive amount of warm product. Prolonged door opening or door ajar. Door not closing properly. Clogged condenser. Evaporator coil blocked with ice or frost. | <ul style="list-style-type: none"> Allow enough time for product to cool down. Close door when not in use. Avoid prolonged door openings. Level the unit (See page 2). Check gasket condition. Check the door spring. Clean the condenser (See page 15). Defrost manually if required (See page 14). |
| Freezer/refrigerator cabinet temperature too high. | <ul style="list-style-type: none"> Electronic control set too high. Poor air circulation in cabinet. Insufficient clearance around cabinet or ambient temperature too high. Clogged condenser | <ul style="list-style-type: none"> Adjust control setting (See page 5). Follow instructions for product loading (See page 4) Keep at least 6" (15 cm) free space around all sides of the freezer. Room temperature is recommended not to exceed 86°F (30°C), 55% RH. Make sure the air flow to the compressor is not obstructed. Clean the condenser (See page 15) |

SHELF AND BASKET, INSTALLATION AND ADJUSTMENT

The unit is supplied with shelves and molded or metallic clips. The unit has slotted pilasters to position the shelves according to the customer's needs.

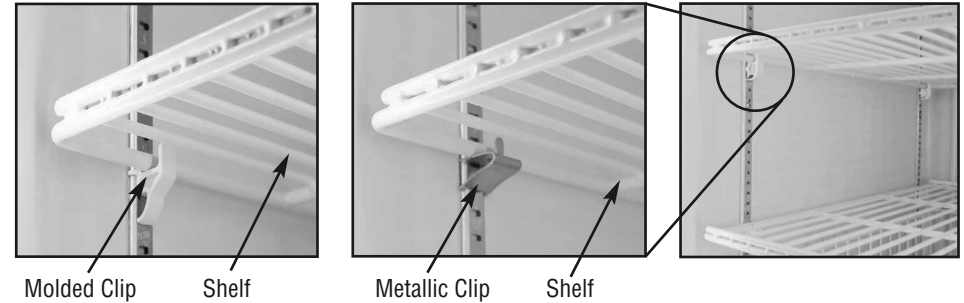

The clips can be removed at any time if a new position is chosen for the shelf or basket. To remove, grab the clip with your thumb and index finger, then push up the bottom surface until the clip is free. Once the clips are in place, put the shelf on top. Once the shelves are securely in place, baskets (if equipped) may be positioned on the shelves.

OPERATING INSTRUCTIONS

⚠ WARNING

Check with your power company if you are not certain of your power supply. Before connecting to power supply the unit should be upright and idle for at least 1 hour.

Once the unit has been installed and the power supply has been connected, press the power switch to the "ON" position using a pen or pencil.

The compressor will start to run after 6 minutes. This can be confirmed by listening for a slight humming or a slight vibration.



NOTE:

If the unit is running and the power supply is interrupted, the unit will not restart immediately. There is a 6 minute delay for compressor protection.

Once the unit is running, the inside temperature will start to cool down within a couple of minutes. Ensure the freezer/refrigerator has reached the desired temperature (this will take between 2 to 3 hours) by checking the electronic control display readout before loading product. **It is strongly recommended to run the freezer/refrigerator empty for 24 hours before loading any products.**

Refer to the sections TEMPERATURE ADJUSTMENT AND SWITCH FUNCTIONS and ELECTRONIC FOOD SAFETY LOCK for temperature controllers and lock instructions.

PRODUCT LOADING

NOTICE:

Ensure the freezer and refrigerator compartments have reached the proper operating temperature before loading product. The electronic control displays the interior cabinet temperatures.

Product loss is not covered under warranty.

For enhanced performance of the unit and to avoid spoilage of perishable products, follow these instructions:

- A** **DO** leave at least 6" (15 cm) free space between the fan and the product for air circulation.
- B** **DO NOT** block the air space behind the grill. Free space is required for proper air circulation.
- C** **DO NOT** stock any products against the evaporator fan. See load limit labels inside the cabinet for reference.
- D** **AVOID** removing the bottom shelves from the inner bottom.
- E** **DO NOT** overstock the unit.

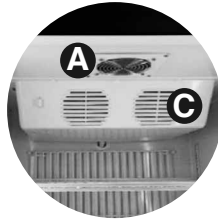
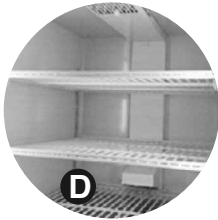

INTERIOR LED STRIP REPLACEMENT

⚠ WARNING

Make sure the unit is disconnected from the power supply before any service. Press the power switch to the "Off" position then unplug the power cord from electrical receptacle. All service work must be conducted by a certified technician only.



Remove silicone corner beads. Pry the screwdriver between plastic cover and cabinet frame. Pry from one end to the other.

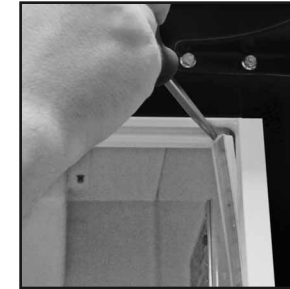

Pry the screwdriver between plastic lens cover and cabinet frame.

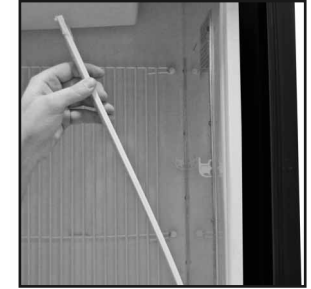

Carefully remove the plastic lens cover from cabinet frame.

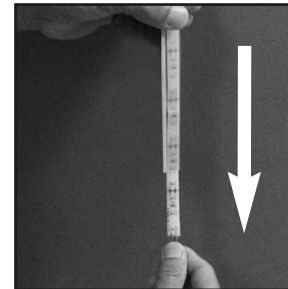

Slide faulty LED strip from plastic cover.



Locate the wire for the LED strip in the compressor compartment and disconnect from connectors.

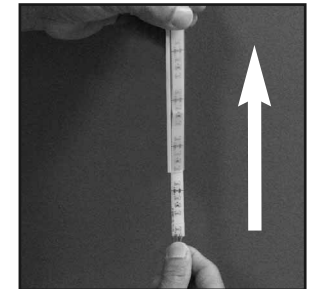

Install the new LED strip into the plastic cover.

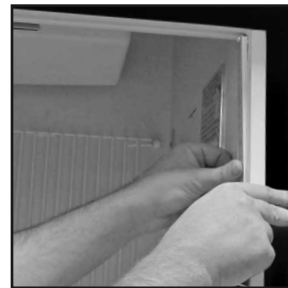

Attach wires, observing color coding. Press lens cover back to cabinet frame.



Snap plastic cover back to cabinet frame. Apply silicone at plastic cover corners.



Plug the unit in and make sure the light switch on the bottom grill is in the "ON" position.

CABINET CLEANING (CONT'D)

EXTERIOR CLEANING

Use only mild non-abrasive liquid cleaner, water and a soft cloth for the painted surfaces and a stainless steel polish and cleaner for the stainless steel surfaces if desired.

CLEANING GLASS DOOR EXTERIOR

Due to the special coating on the glass, use only a mild, non-abrasive liquid cleaner, water, and a soft cloth. The same applies to the plastic door frame.

ANTI FOG GLASS DOOR INTERIOR

The anti-fog glass door has a protective film on the inner side. After the unit has been installed, peel and remove the protective film covering the inner glass surface.

The Anti-Fog coating is a scratch resistant, permanent coating applied on the inner surface of the door glass. It prevents fogging and icing of cold glass surface after door opening and closing.

Cleaning can be performed using common household glass cleaners (Sidolin®, Windex®, Mr. Muscle®) and a tissue or paper towel. However, on very cold surfaces these cleaners may freeze. In these cases a mixture with 30% pure alcohol and water may be used. At temperatures above 0°C, warm hand temperature water with a mild detergent can be applied.

Do not use abrasive cleaners or materials like Ajax®, Scotch Brite® or Steel Wool.

Do not contaminate the door with silicone.

Do not use tape, glue, stickers, attachments, magic markers or similar products on the coating.

Do not use razor blades or any other mechanical device to remove foreign residues or objects directly from the coating.

Do not use cleaners or materials that hinder the anti-fog performance by leaving residue or damaging the surface. Examples of these cleaners include: ArmorAll®, Tilex®, Bleach, Windex® No-Drip, Windex® Wipes, Pledge®, or any product containing silicone oils or waxes.

Recommended cleaners include: Greased Lightning®, Formula 409® Grease & Grime®, Fantastik®, Windex® Vinegar, Windex® Original, MicroClean Professional APC® (formerly Now® all purpose cleaner), Mean Green®, or Mr. Clean® (degreasing cleaners).

Recommended cleaning is with a soft dry or slightly damp towel, or with one of the degreasing cleaners listed above.

TEMPERATURE ADJUSTMENT AND SWITCH FUNCTIONS

The unit is equipped with two electronic controllers.

The controller on the right side of the front bottom grill controls:

- Temperature inside the freezer compartment through operation of compressor, condenser fan, and evaporator unit. The freezer electronic controller turns the refrigeration system OFF when the freezer compartment reaches the set temperature, and turns the refrigeration system ON after the freezer compartment temperature rises by 8°F or after 7 minutes, whichever lasts longer.
- Food-safety lock for the freezer (lower compartment)

The controller on the left side of the front bottom grill controls:

- Temperature inside the refrigerator compartment through operation of refrigerator recirculation fan and cold-intake-air fan. The refrigerator electronic control turns the cold-air-intake fan OFF when the refrigerator compartment reaches the set temperature, and turns the cold-air-intake fan ON after the refrigerator compartment temperature rises by 3°F.
The re-circulating fan is located inside the refrigerator compartment (lower back) and runs continuously except when the refrigerator door is open. The cold-air-intake fan is located in the freezer compartment in front of the evaporator shroud.
- Food-safety lock for the refrigerator compartment (upper compartment)

The electronic controllers display actual temperatures inside the respective compartments. The recirculating fan runs continuously except when the refrigerator door is open.

To adjust the set temperature inside a freezer or refrigerator compartment, follow these steps:

1. Locate the respective electronic controller (left or right side of the bottom grill)
2. Press and release P button; the set temperature and SP1 are displayed alternatively on the controller
2. Press the UP or DOWN buttons to adjust the set temperature.
3. Press P to store the adjusted value. The electronic control will return to actual compartment temperature display. The U button on the electronic control is also used for displaying compartment and evaporator temperatures (Pr1 and Pr2 parameters) by alternately pressing and releasing the button.

There are two switches located on the right hand side of the freezer controller. Their functions are to manually switch electronic components of the entire unit

1. POWER switch turns the refrigeration system (including all electrical parts) ON or OFF. (use a pen or pencil to press the power switch to the ON or OFF position).
2. LIGHT switch turns the internal and external lights ON or OFF.

ELECTRONIC CONTROLLER



ELECTRONIC CONTROL

POWER LIGHT

CONTROLLER ALARMS AND SIGNALS

The electronic controllers can detect and signal several alarm conditions: high/low temperatures, door open and open or short-circuited temperature probes. If the alarm conditions last longer than pre-programmed time delays, the controller will turn ON an audio signal (buzzer). Also, an LED light located in the upper left corner of the controller, next to the caution symbol, will glow in case an alarm is active.

Once the alarm conditions have been fixed, the controller will turn off the alarms on its own. Alarms can be disabled by pressing any controller button, during alarm conditions.

X34L ELECTRONIC CONTROLLER

| Message | Cause | Action |
|-----------------------------------|-------------------------------------------|--------------------------------------------------------------------------------------------------------------------------------------------------------------------------|
| <i>Pr 1 d SC</i> | Cabinet temperature probe open | <ul style="list-style-type: none"> • Check connections • Replace probe |
| <i>Pr 1 Short CC</i> | Cabinet temperature probe short-circuited | |
| <i>Pr 2 d SC</i> | Defrost probe open | <ul style="list-style-type: none"> • Check connection • Replace probe |
| <i>Pr 2 Short CC</i> | Defrost probe short-circuited | |
| <i>EPe</i> | Internal memory error | • Replace controller |
| <i>Err</i> | Internal memory error | • Replace controller |
| <i>Start dELAY</i> | Start up delay in progress | • Wait for 6 minutes |
| <i>H I ALARn</i> | High temperature alarm in progress | <ul style="list-style-type: none"> • Check door closing and gasket seal for damage. • See Troubleshooting (pages 18-19) |
| <i>LO ALARn</i> | Low temperature alarm in progress | <ul style="list-style-type: none"> • Check controller. probes and compressor relay. • Adjust set temperature |
| <i>door oPEn</i> | Door open | • Close door |
| <i>dEFroSt</i> | Defrosting in progress | • none |
| <i>Post dEFroSt</i> | Post-defrosting in progress | • none |
| <i>CC CYCLE</i> | “Turbo” mode active | • none |
| <i>HAC</i> | Stored HACCP alarm on controller | • See Accessing and Resetting Alarms Data on the Electronic Controller (pages 12-13) |
| <i>H I°F dELAY or H I°C dELAY</i> | Restocking alarm delay | • See Restocking Delay (page 12) |
| <i>AL</i> | Digital input alarm in progress | • Presently not used. |
| <i>LoCHed</i> | Door locked | • Determine cause (high temperature, sensor failure or controller error) and rectify. Inspect food. Reset lock. |
| <i>UnLoCHed</i> | Door unlocked | • none |
| <i>dFt</i> | Very low voltage event | <ul style="list-style-type: none"> • Press any button to clear the dFt message. • Check setpoint and adjust if changed by the low voltage event. |

CONDENSER CLEANING

The unit is designed for minimal condenser cleaning. With the “lint free” condenser design, most dust and dirt will pass right through the condenser. To insure the proper operation, we recommend scheduled check-ups and cleaning every three to four months. This period may be shorter or longer depending on the location in which the unit was installed. A dirty condenser can result in a voided warranty, part failure, product loss, and higher electrical cost. The steps to clean the condenser are as follows:

1. Remove the front bottom grill (see page 14)
2. Press the power switch to the “Off” position.
3. Unplug power cord from electrical receptacle.
4. Brush the dirt, dust and paper off the condenser coil plate, all the way to the fan. Use either a vacuum or blow with a compressed air supply if available.
5. When finished with cleaning, plug power cord back into receptacle.
6. Press the power switch to the “On” position.
7. Replace bottom grill (see page 14)

NOTE:

The cleaning of the condenser is a service not covered under the warranty

CABINET CLEANING

⚠ WARNING

To reduce the risk of fire, electrical shock or personal injury, disconnect the unit from the power source before cleaning. Press the power switch to the “Off” position, then unplug the power cord from the receptacle. Keep liquids away from electrical and electronic components.

⚠ CAUTION

Do not apply hot water on cold glass components. Allow glass to warm sufficiently to prevent shattering.

⚠ CAUTION

Do not use ammonia or bleach based cleaners or abrasive type cleaners. Do not use abrasive cleaning pads.

To clean the exterior whether it has the original finish or a decal package, use only a mild non-abrasive liquid cleaner, water and a soft cloth. For stainless steel parts, a commercial stainless steel polish and cleaner can be used. Always apply the cleaner to the soft cloth and then clean the unit. Never apply the cleaner directly to the unit. Excess liquid applied to the surface may seep into the electronic control and switches which can cause an electrical hazard or a malfunction.

DO NOT USE abrasive or caustic cleaners, scouring pads, solvents or flammable liquids.

GENERAL

The unit should be cleaned at regular intervals to meet a good standard of hygiene and to keep the unit attractive as an effective point of purchase display.

INTERIOR CLEANING

Use only mild non-abrasive liquid cleaner, water and a soft cloth for the entire unit interior. Make sure to wipe off all residue.

MANUAL DEFROST

This unit is designed for automatic defrost. Every eight hours the refrigeration system is turned OFF and the defrost/drain heaters are activated to melt the ice from the evaporator coil and drain pan. If the unit is not leveled properly, the water may not drain out of the unit, it will re-freeze and ice gradually builds up. Excessive ice buildup reduces cooling performance and may cause the failure of refrigeration system and product loss. Ice buildup may be noticed through the evaporator fan grill on the coil fins.

To perform a manual defrost, follow these steps:

1. Press the UP arrow button and hold it for 6 seconds until the defrost symbol illuminates.
2. Wait until the electronic control stops defrost (the defrost symbol disappears).
3. If ice is still noticeable on the evaporator, press the power switch to the "Off" position then disconnect the unit from the power supply.
4. Take down the evaporator shroud and use a hair dryer to quickly melt the ice.
5. Make sure the unit is leveled side to side, and front to back or slightly tilted front to back.
6. Replace the evaporator shroud.

HOW TO REMOVE THE FRONT BOTTOM GRILL



With a Phillips screwdriver remove the bottom screws from the grill.

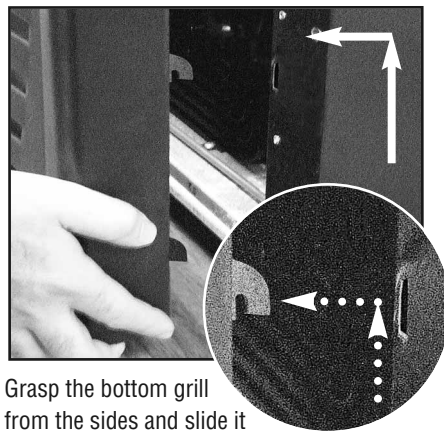

Grasp the bottom grill from the sides and slide it up and towards you to release the hooks.

To replace bottom grill, align hooks of the grill with slots and slide the grill back onto the unit. Replace the bottom screws to secure the grill to the cabinet.

CONTROLLER ALARMS AND SIGNALS (CONT'D)

Y39L ELECTRONIC CONTROLLER

| Message | Cause | Action |
|---------------------|-------------------------------------------|-------------------------------------------------------------------------------------------------------------------------------------|
| <i>Pr1 d SC</i> | Cabinet temperature probe open | <ul style="list-style-type: none"> • Check connections • Replace probe |
| <i>Pr1 Short CC</i> | Cabinet temperature probe short-circuited | |
| <i>Pr2 d SC</i> | Defrost probe open | <ul style="list-style-type: none"> • Check connection • Replace probe |
| <i>Pr2 Short CC</i> | Defrost probe short-circuited | |
| <i>Int Error</i> | Internal memory error | <ul style="list-style-type: none"> • Replace controller |
| <i>StArT dELAY</i> | Start up delay in progress | <ul style="list-style-type: none"> • Wait for 6 minutes |
| <i>H I ALArN</i> | High temperature alarm in progress | <ul style="list-style-type: none"> • Check door • See Troubleshooting (page 18) |
| <i>LO ALArN</i> | Low temperature alarm in progress | <ul style="list-style-type: none"> • Adjust set temperature |
| <i>door oPEn</i> | Door open | <ul style="list-style-type: none"> • Close door |
| <i>CC CYCLE</i> | "Turbo" mode active | <ul style="list-style-type: none"> • none |
| <i>H I LO dELAY</i> | Alarm delay after a restocking command | <ul style="list-style-type: none"> • Press the door switch 3 times repeatedly within 5 seconds to enable restocking. |

CONTROLLER SYMBOLS AND FUNCTIONS

Y39L ELECTRONIC CONTROLLER



At the left side of the controller display are the following LED indicators:

- 

1. Indicates compressor status:
 Light on - Compressor cooling on
 Light off - Compressor cooling off
 Light flashing - Start-up delay in progress
- 

2. Indicates defrost status:
 Light on - Defrost in progress
 Light flashing - Freezer in dripping mode
- 

3. Indicates fan status:
 Light on - Cabinet fan ON
 Light off - Cabinet fan OFF
 Light flashing - Start-up delay in progress after defrost.
- 







4. Indicates the alarm status:
 Light on - Alarm is on
 Light off - Alarm is off
 Light flashing - Alarm silenced or memorized

CONTROLLER SYMBOLS AND FUNCTIONS (CONT'D)

X34L ELECTRONIC CONTROLLER



At the left side of the controller display are the following LED indicators:

- 
1. Indicates compressor status:
 Light on - Compressor cooling on
 Light off - Compressor cooling off
 Light flashing - Start-up delay in progress
- 
2. Indicates defrost status:
 Light on - Defrost in progress
 Light flashing - Freezer in dripping mode
- 
3. Indicates fan status:
 Light on - Cabinet fan ON
 Light off - Cabinet fan OFF
 Light flashing - Start-up delay in progress after defrost.
- 
4. Indicates internal clock is running.
 Flashing slowly - Clock error (ie:clock chip not working).
 Flashing rapidly - Clock battery is drained.
 Cyclical Flashing for delays indication:
 One flash, 2 seconds off - High temperature alarm delay (standard)
 Two flashes, 2 seconds off - High temperature alarm delay in defrost and post-defrost
 Three flashes, 2 seconds off - High temperature alarm delay during restocking
 Four flashes, 2 seconds off - High temperature alarm delay after power-up
- 
5. Indicates the alarm status:
 Light on - Alarm is on
 Light off - Alarm is off
 Light flashing - Alarm silenced or memorized
- 
6. Indicates the lock status:
 Light on - Unit locked
 Light off - Unit unlocked
 Light Flashing - Locking delayed

ACCESSING AND RESETTING ALARMS DATA ON THE ELECTRONIC CONTROLLER CONT'D.

The chart below (Figure 6) shows how to navigate through the controller to access alarm data.

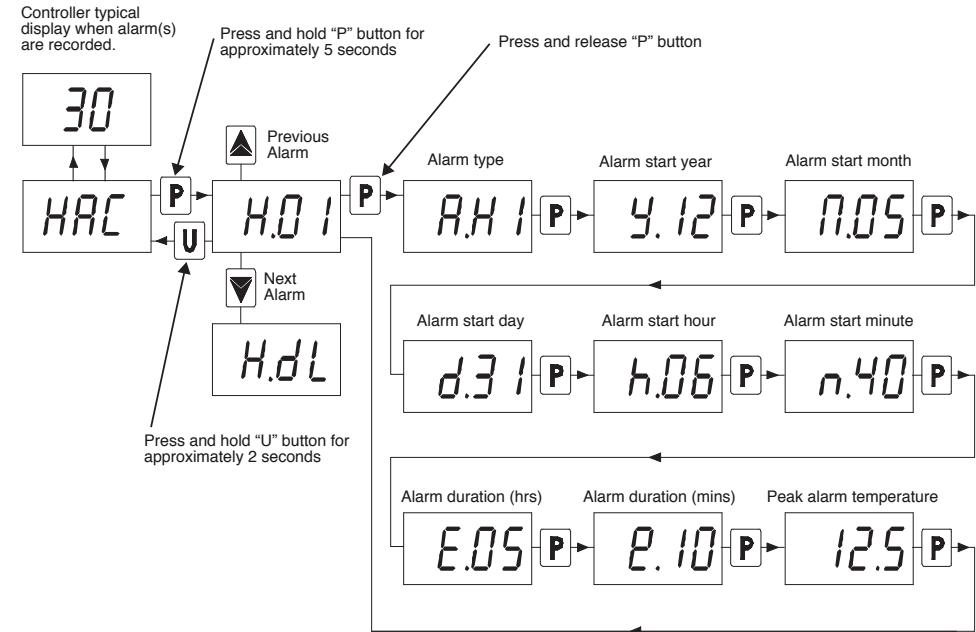

Figure 6

If an alarm flashes (H.01...H.10) when a user scrolls through the alarm list, the flashing indicates that the alarm has never been reviewed. After pressing the P key on an alarm and reviewing any of its data, the alarm will be displayed solid afterwards to indicate that the alarm has been reviewed. If the alarm is still ongoing at the time of its display, the data are displayed but the ongoing alarm will be flashing all time. In the event of non-reviewed and/or still ongoing alarms, the electronic control displays the message "HAC", alternating it with the temperature reading.

An alarm can be deleted from the controller memory by holding the arrow-down button for more than 5 seconds while one of the alarm data is displayed. After alarm deletion, the controller displays three dashes: ---. Similarly, the value of the "H.dL" parameter can be reset to 0 by holding the arrow-down button for more than 5 seconds while the value is displayed. All recorded alarms can be deleted at once, by holding the arrow down button in the controller regular display. After all alarms deletion, the controller displays three dashes: ---.

FIELD TESTING OF THE FOOD SAFETY LOCK

Ensure the unit power cord is plugged into an electrical receptacle and the electronic controller is powered. Proper operation of the food safety lock can be verified by following steps:

1. Make sure the compartment door that you want to check is closed and unlocked.
2. Locate the respective controller for the unit compartment door. Push and hold "P" and "U" buttons on the controller simultaneously for 5 seconds (Figure 5) until the controller start scrolling "LocHed" message and beeps once. The lock should engage and the door should stay locked for about 20 seconds. Then, the controller resets the lock, unlocks the compartment door, scrolls "UnLocked" message three times, and beeps twice

ENTRAPMENT LOCK RELEASE

The lock is equipped with an emergency entrapment release feature.

In the event of entrapment the door can be unlocked from inside the compartment by pressing and holding the pushbutton, then pushing against the door (Figure 4).



RESTOCKING DELAY

During or immediately after product stocking, temperatures inside the cabinet food compartment may rise above the food safety temperature limits, thereby causing a potential for nuisance door locking. To prevent such nuisance locking events, the restocking alarm delay needs to be activated. This delay can be activated by slightly opening and closing the compartment door repeatedly three times within 5 seconds.

After the triple switch activation, a scrolling message “HI F deLAY or HI C deLAY” is displayed three times on the controller accompanied by two buzzer beeps (if buzzer enabled). The clock symbol on the controller will rapidly flash three (3) times during restocking delay. This confirms the delay has been accepted by the electronic controller, that any active high temperature alarm is cancelled, and that the restocking delay is now in progress. This delay prevents the lock from being activated for a factory pre-set time (75 minutes). During this delay time, the freezer should bring the temperature in the food storage temperature within normal operating range.

Ensure the door is unlocked after restocking delay activation and door closing.

To unlock the door, press and hold simultaneously P and U buttons for 5 seconds until the controller starts scrolling “UnLoCkEd” message.

If the Restocking Delay has been entered inadvertently, it can be terminated by pressing and holding the “U” button for 5 seconds until the controller beeps once (if buzzer enabled) and the clock symbol stops with three rapid flashes.

ACCESSING AND RESETTING ALARMS DATA ON THE ELECTRONIC CONTROLLER

The electronic controller records two types of alarms: high temperature and power failures (black outs). If there have been multiple alarms, the electronic controller records up to 10 alarms sorts them from the most recent (H.01) to the oldest (H.10). If there have been more than 10 alarms, the electronic controller deletes alarms on historical basis (newer ones are kept), and keeps the number of deleted alarms in the parameter H.dL by increasing this variable by 1 each time an alarm is deleted.

For each recorded alarm, the following data are recorded:

- Alarm type
 - A.H1, high temperature alarm
 - A.bo, power failure (black out)
- Alarm start date and time
 - y.dd, dd = 10 ÷ 99, last two digits of the year
 - M.dd, dd = 1 ÷ 12, month
 - d.dd, dd = 1 ÷ 31, day
 - h.dd, dd = 0 ÷ 23, hour
 - n.dd, dd = 0 ÷ 59, minute

NOTE: Since the electronic controller is powered through a battery backup device, the electronic controller will record power failure when the battery backup drains out, not when the freezer loses power on the electric receptacle.

- Alarm duration
 - E.dd, dd = 0 ÷ 99, number of hours the alarm lasted
 - e.dd, dd = 0 ÷ 23, number of minutes the alarm lasted
- Peak temperature in the cabinet during the high temperature alarm condition (A.H1), or temperature in the cabinet when the power is restored after power failure (A.bo)

The chart (Figure 6.) on Page 13 shows how to navigate through the controller to access alarm data.

ELECTRONIC FOOD SAFETY LOCK (IF EQUIPPED)

⚠ WARNING

READ THIS SECTION IN ITS ENTIRETY AND FOLLOW OUTLINED INSTRUCTIONS BEFORE OPERATING THE UNIT. IN THE EVENT THE ELECTRONIC SAFETY LOCK HAS LOCKED THE UNIT, THE FOOD IN THE UNIT MUST BE INSPECTED TO INSURE ITS SAFETY AND QUALITY FOR CONSUMPTION.

⚠ ATTENTION

IMMEDIATELY AFTER POWERING ON THE UNIT, “HAC” MESSAGE MAY BE SCROLLING ON THE ELECTRONIC CONTROLLER. “HAC” INDICATES A PRESENT, OR PAST UNREVIEWED, HIGH TEMPERATURE ALARM CONDITION AND/OR POWER LOSS. TO REVIEW DATE, TIME AND DURATIONS OF THOSE EVENTS, REFER TO THE APPLICABLE SECTION BELOW. TO CLEAR “HAC” MESSAGE, HOLD DOWN THE ARROW BUTTON  ON THE CONTROLLER UNTIL THREE DASHES APPEAR, THEN RELEASE THE BUTTON. “HAC” SCROLLING MESSAGE SHOULD DISAPPEAR.

⚠ ATTENTION

TURN THE BATTERY BACKUP OFF WHEN THE UNIT IS DISCONNECTED FROM THE MAIN POWER SOURCE TO AVOID DEPLETING THE BATTERY BACKUP CHARGE. DEPLETING THE BATTERY BACKUP CHARGE REDUCES ITS LIFECYCLE AND LEADS TO BATTERY REPLACEMENT. SEE THE LABELS ON THE UNIT AND SECTIONS BELOW HOW TO TURN THE BATTERY BACKUP ON/OFF.

GENERAL DESCRIPTION

The purpose of the electronic food safety lock is to lock the unit door in the event of unit malfunctioning, thereby preventing public access to potentially hazardous food. The electronic controller continuously monitors temperature inside the food storage compartment and locks the door via a mechanical lock if the temperature stays above these limits:

- 41°F (5°C) for 30 minutes or longer in refrigerators
- 0°F (-18°C) for 30 minutes or longer in freezers.

The electronic food safety lock system consists of these six (6) major components:

- **Electronic controller(s).** A factory pre-programmed electronic controller that monitors temperature inside the food compartment and activates the mechanical lock if food safety temperature limits are reached. For Hybrid (Freezer and Refrigerator compartments) two controllers are used to monitor, control, and lock each compartment independently. The left side controller is for the upper refrigerator compartment, and the right side controller for the lower freezer compartment. See Figure 1 for the controller's location (right side controller shown).



Figure 1



Figure 2

- **Mechanical lock(s).** A mechanical locking mechanism located on the left side of unit. The lock mechanically locks the compartment door when it receives an electrical signal from the electronic controller. For Hybrid units, each compartment has its own lock. See Figure 2 for the lock(s) location.

- **Lock status Indicator Board(s) (LSIB).** An electronic PCB that provides power to the adjacent lock and shows the lock status (locked or unlocked) via two onboard LEDs. A solid green LED indicates that 12VDC is present at the board. During normal operation, the green LED is always on when the unit is powered. A flashing red LED indicates that the lock/door is in the locked state. See Figure 2 for the board(s) location. For Hybrid units, there are two LSIB boards to power the adjacent lock for each compartment.

- **Battery Backup.** The purpose of the battery backup is to supply backup electricity to the electronic controller(s) and to the mechanical locks in the event of power failure (black out). It allows the electronic controllers to continue monitoring food compartment temperatures during prolonged power losses, and activates the door locking mechanism when food safety temperature limits are reached. The battery backup powers ONLY the controller(s) and lock(s) during a power outage and does not power any other electrical components of the freezer/refrigerator. There is only one battery backup per unit. See Figure 3 for its location and how to turn it ON or OFF.

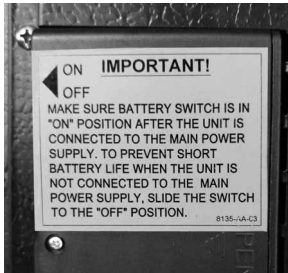

Figure 3



Figure 4

- **Lock key(s).** A special-purpose key that is used to temporarily override the mechanical lock to gain access to the inside of the locked out compartment. See Figure 2 for the lock key and slot location.

- **Entrapment lock(s) release.** This is an emergency entrapment release feature to temporarily override the lock from the inside of the locked out compartment. For Hybrid units, each compartment has its own entrapment lock release mechanism. See Figure 4 for the entrapment release location.

UNIT LOCKING OPERATION

Depowered State: In the completely depowered state (power cord unplugged and battery backup switched off), the door(s) to the unit food compartment(s) are locked. To gain access to the inside of the compartment(s), insert the lock key into the key slot and turn it clockwise until resistance is felt. Hold the lock key in that position, and use a free hand to grab the compartment door handle and pull the door open.

After Powering On: Immediately after powering the unit by plugging the unit power cord into a wall receptacle and switching on the battery backup, the compartment doors are still locked. To unlock the doors and reset the lock, press and hold simultaneously P and U buttons (Figure 5) on each compartment controller for about 5 seconds and until the controller buzzer beeps twice and scrolls “Unlocked” message three times. The unit is now in its regular operation, ready for products stocking after temperature pull-down and stabilization period, and use by customers thereafter.



Figure 5

UNIT LOCKING OPERATION (CONT'D)

During Normal Operation: During unit operation, the food safety lock can be triggered to lock the door(s) by any of the following triggers: (1) high temperature alarms, (2) cabinet sensor open or short fault, or (3) controller internal errors. An alarm condition will cause the controller to beep cyclically and a scrolling “Locked” message will be displayed. To gain temporary access to the inside of the locked out compartment while the locking trigger(s) is still active, press and hold simultaneously P and U buttons on the respective controller for about five (5) seconds and until the controller buzzer beeps twice and the controller scrolls “Unlocked” message. The door stays unlocked for about 20 seconds, then the controller relocks the door upon closing, beeps once, and scrolls “Locked” message three times.

Lock Reset: After all locking trigger(s) are rectified, such as temperature falls below acceptable high limit levels (41°F (5°C) for refrigerators or 0°F (-18°C) for freezers), the door remains locked until the lock is reset through human intervention. To unlock the door, reset the lock, and return the unit to its regular operation, press and hold simultaneously P and U buttons for about 5 seconds and until the controller buzzer beeps twice and the controller scrolls “Unlocked” message three times.

BATTERY BACKUP OPERATION

The battery backup is located at the back of the unit. Its function is to provide power to the controller(s) and mechanical lock(s) during the main power failures so that the controller can keep monitoring the cabinet temperature and activate the lock(s) during prolonged blackouts. The battery backup has eight AA alkaline batteries connected in series to provide 12VDC.

To activate the battery backup, slide the switch on top of the battery backup enclosure to ON position (Figure 3). To prevent the battery backup from premature charge drain and to extend its lifecycle, slide the switch on top of the battery backup enclosure to OFF position (Figure 3) when the unit is not in use and disconnected from the main power source.

A set of new eight batteries is capable of powering the electronic lock safety system controller(s) and lock(s) for about 7 hours.

To check whether the battery backup is functioning, follow these steps:

1. Ensure the battery backup switch is in the ON position.
2. Turn the power switch beside the freezer controller to off position to disconnect the main power to the unit. If the controllers lose power and the locks engage immediately or within a few minutes, then the batteries in battery backup enclosure should be replaced. To replace batteries, undo the screw on the battery cover and replace the eight AA batteries with a new set of alkaline batteries (Figure 7). Use high quality brands such as Duracell, Panasonic, etc. Ensure the battery polarity is followed as per indicators on the backup housing.



Figure 7

3. Repeat steps 1 and 2 periodically, every 3 to 4 months.