



# XP18HP

U S E R M A N U A L



REV: XP18HP\_rev06172022

This manual provides information regarding the operation and maintenance of these products. We have made every effort to ensure the accuracy of the information in this manual. We reserve the right to change this product at any time without prior notice.

5800 Ontario Mills Pkwy  
Ontario, CA 91764 USA  
[www.duromaxpower.com](http://www.duromaxpower.com)  
Call our Customer Care Team Toll Free 8-5pm PST Mon-Fri  
**844-DUROMAX**



# CONTENTS

<b>1.</b>	<b>Introduction</b>	
	Introduction .....	6
	General Safety Procedures .....	8
	Unit and Purchase Information.....	12
	Engine Components .....	13
	Package Contents .....	14
<b>2.</b>	<b>Engine Setup</b>	
	Adding Oil .....	16
	Adding Gasoline .....	17
<b>3.</b>	<b>Starting the Engine</b>	
	Check the Oil .....	20
	Check the Fuel Level .....	21
	Starting the Engine .....	22
<b>4.</b>	<b>Maintenance and Care</b>	
	Maintenance Schedule.....	26
	Break-In Period .....	27
	Maintenance Log.....	27
	Checking the Oil .....	28
	Changing the Oil.....	29
	Changing the Air Filter.....	30
	Spark Plug Maintenance .....	32
	Emptying the Gas Tank .....	34
	Storing the Engine for Same Day Use .....	36
	Storing the Engine for Use Within 30 Days.....	37
	Storing the Engine for Longer Than 30 Days.....	38
<b>5.</b>	<b>Specifications</b>	
	Specifications.....	43
	Adjustment, Torque, and Timing Specifications .....	44
	Engine Diagrams .....	45
	Wiring Diagram .....	47

# CONTENTS

6.	Troubleshooting .....	51
7.	Warranty .....	54
8.	Customer service .....	58

**For more information and resources on this model scan the QR code below to link to our website product information page.**





POWERING EVERYONE...  
***ANYWHERE!***



## THE DUROMAX WAY

The DuroMax Way is more than just a brand, it is our understanding and appreciation of just how important power can be to someone without it...



### DUROMAX FOR HOME

Electricity in our home not only provides comfort but safety as well. From keeping the heat or A/C on to keeping our food cold, power is essential to our daily lives. Inevitably when disaster strikes and we are left without power for a prolonged period of time, our way of life is put at risk. This is by far the most critical time for reliable portable power.



### DUROMAX FOR WORK

On the job site, portable power allows you the ability to get work done in remote locations when traditional power sources are usually unavailable. Equipment like table saws, sanders, and work lights are a necessity and portable power can play a critical role in getting a job done successfully and efficiently.



### DUROMAX FOR PLAY

Camping outdoors in a remote location can get one in touch with nature and allow them to forget the stress of the day to day grind. Here portable power can provide comfort as well as safety. With portable power, you can keep your cell phone charged, light up your campsite, or even brew a cup of coffee, all while being miles from civilization.

**The DuroMax Way is a commitment to excellence.** This vision is focused on the quality, reliability, and durability of our products combined with outstanding customer service. We understand that having dependable power whenever and wherever you need it provides comfort, safety, and peace of mind. It is through this philosophy that DuroMax achieves our vision of...

# POWERING EVERYONE... ANYWHERE!

# INTRODUCTION

DuroMax Power Equipment is headquartered in Ontario, California and is the industry's leader in Dual Fuel portable generator technology. In addition to a full assortment of portable generators ranging from digital inverters to large 15,000-watt portable standby units, their product line includes pressure washers, engines, pumps, and accessories.

The foundation of our company is built on quality, reliability, durability, and customer service. At DuroMax our vision is simple, we are committed to Powering Everyone... Anywhere!



## Notice Regarding Emissions

Engines that are certified to comply with U.S. EPA emission regulations for SORE (Small off Road Equipment), are certified to operate on regular unleaded gasoline and may include the following emission control systems: (EM) Engine Modifications and (TWC) Three-Way Catalyst (if so equipped).

# GENERAL SAFETY PROCEDURES



## SAFETY ALERT SYMBOL

The safety alert symbol is used with one of the safety words (**DANGER**, **WARNING**, or **CAUTION**) to alert you of hazards. Please pay attention to these hazard notices both in this manual and on the engine.

### Please familiarize yourself with the following safety symbols and words:

- **DANGER**: Indicates a hazard that will result in serious injury or death if instructions are not followed.
- **WARNING**: Indicates a strong possibility of causing serious injury or death if instructions are not followed.
- **CAUTION**: Indicates a possibility of personal injury or equipment damage if instructions are not followed.



**DANGER**: This engine produces poisonous carbon monoxide gas when running. This gas is both odorless and colorless. Even if you do not see or smell gas, carbon monoxide may still be present. Breathing this poison can lead to headaches, dizziness, drowsiness, and eventually death.

- Use outdoors **ONLY** in non-confined areas.
- Keep several feet of clearance on all sides to allow proper ventilation of the engine.



**WARNING**: The exhaust from this product contains chemicals known to the State of California to cause cancer, birth defects, or other reproductive harm.



**WARNING**: This engine produces heat when running. Temperatures near exhaust can exceed 150°F (65°C).

- Do not touch hot surfaces. Pay attention to warning labels on the engine denoting hot parts of the machine.
- Allow engine to cool several minutes after use before touching engine or areas which heat during use.





**WARNING:** This engine may emit highly flammable and explosive gasoline vapors, which can cause severe burns or even death. A nearby open flame can lead to an explosion even if not directly in contact with gasoline.

- Do not operate near an open flame.
- Do not smoke near the engine.
- Always operate on a firm, level surface.
- Always turn the engine off before refueling.
- Allow engine to cool for at least 2 minutes before removing the fuel cap. Loosen cap slowly to relieve pressure in the tank.
- Do not overfill the gas tank. Gas may expand during operation. Do not fill to the top of the tank.
- Always check for spilled gas before operating.
- Empty the gasoline tank before storing or transporting the engine.
- Before transporting, turn the fuel valve to the off position and disconnect the spark plug.

# GENERAL SAFETY PROCEDURES (CONTINUED)

In addition to the above safety notices, please familiarize yourself with the safety and hazard markings on the engine.



<b>⚠ DANGER</b>		
<p>Using power equipment indoors CAN KILL YOU IN MINUTES.</p> <p>Power equipment exhaust contains carbon monoxide. This is a poison you cannot see or smell.</p>	<p><b>NEVER</b> use inside a home or garage, <b>EVEN IF</b> doors and windows are open.</p>	<p>Only use <b>OUTSIDE</b> and far away from windows, doors, and vents.</p>



**ATTENTION**  
CHECK ENGINE OIL LEVEL  
BEFORE EACH START  
CAPACITY: 1.1L/37oz (US)



**WARNING**  
Check that there is no fuel spillage  
or fuel leakage.  
Engine must be off before fueling.

# UNIT AND PURCHASE INFORMATION

## Serial Number



### Serial number

The serial number is located on the engine block, to the left of the oil fill.



### Serial number format

The serial number will be shown in two parts. The engine model, followed by the serial number.

Engine Model: \_\_\_\_\_

Serial Number: \_\_\_\_\_

## STAPLE RECEIPT HERE

A purchase receipt may be necessary for warranty parts or service in the future. If you have a paper receipt staple it here for easy reference.

If you purchased the unit online, save the email receipt where you can access it, and record your details here for convenience in the future.

Purchase Date: \_\_\_\_\_

Order Number: \_\_\_\_\_

Retailer Name: \_\_\_\_\_

# ENGINE COMPONENTS

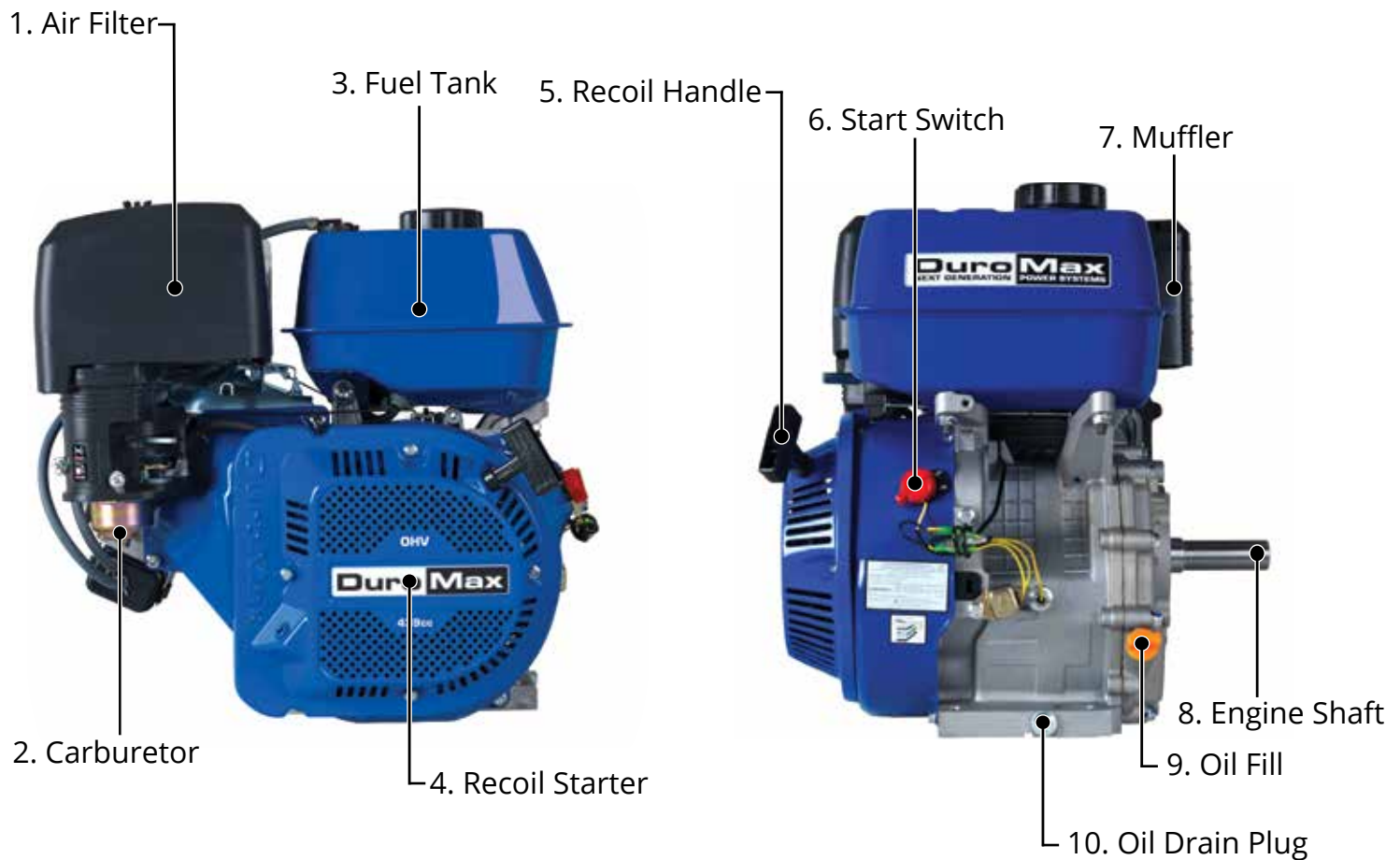

1. **Air Filter** - A removable, cleanable, oiled, element that cleans the air going into the engine.
2. **Carburetor** - A component used to control the air fuel mixture of the engine.
3. **Fuel Tank** - All metal 1.7 gallon gasoline fuel tank.
4. **Recoil Starter** - An easy pull recoil start to start the engine without the electric start.
5. **Recoil Handle** - An easy grip handle used to pull the recoil starter rope.
6. **Start Switch** - An easy to use switch used to turn the engine on or off.
7. **Muffler** - A noise dampening component that helps lower the engine decibel level.
8. **Engine Shaft** - A 1" diameter, 2-3/4" long all metal shaft with a 1/4" key-way.
9. **Oil Fill** - An easy access location to fill the oil for the engine.
10. **Oil Drain Plug** - An easy to remove oil plug that is used to drain the oil.

# PACKAGE CONTENTS

Your engine comes with the items listed below. Please check to see that all of the following items are included with your engine.



## Spark Plug Wrench

Used in spark plug maintenance, inspection, and installation.



## Oil Funnel

Used to add oil to the engine without messy spills.

- Note: Actual tools may differ in appearance or design from image shown.



## ENGINE SETUP

Proper setup of your engine will get you going as soon as possible while making sure you and your equipment are safe and cared for.

# ENGINE SETUP

## Step 1- Adding Oil

The engine requires engine oil to operate properly. The engine, when new from the package contains no oil in the crankcase\*. You must add the proper amount of oil before operating the engine for the first time. This amount is equal to the oil capacity of the engine crankcase:

<b>Model Number</b>	XP18HP
<b>Engine Oil Capacity</b>	37.2 fl. oz (1.1 L)



**WARNING:** Do not apply engine oils with additives or 2-stroke gasoline engine oils; they don't have enough lubrication and may shorten the engine's service life.

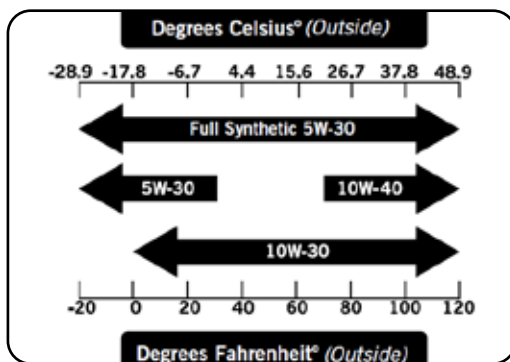

### Engine oil recommended: SAE 10W-30.

Viscosity varies with regions and temperatures. Choose your oil viscosity using the chart to the left.

\* A small amount of oil from factory testing may be present on arrival.

\* Synthetic oil may be used after the 8 hour initial break-in period. Using synthetic oil does not increase the recommended oil change interval. Full synthetic 5W-30 oil will aid in starting in cold temperatures <5°C (41°F).

## 1. Add oil

- Make sure the engine is on a level surface.
- Unscrew the oil filler cap from the engine .
- Using a funnel, add the appropriate amount of oil into the crankcase. You can check the oil level of the engine with the dipstick located below the oil filler cap. Simply pull the dipstick out and the indicated oil level is on the end of the stick.
- Replace oil filler cap.



**WARNING:** DO NOT overfill the crankcase. This may damage the motor and shorten overall life of your Engine.



## Step 2 - Adding Gasoline



### Add gasoline

- Make sure the engine is on a level surface.
- Unscrew gas cap and set aside (NOTE: the gas cap may be tight and hard to unscrew).
- Slowly add unleaded gasoline to the fuel tank. Be careful not to overfill.
- Replace fuel cap and wipe up any spilled gasoline with a dry cloth.

<b>Model Number</b>	XP18HP
<b>Gas Tank Capacity</b>	1.7 US Gal. (6.4L)



**WARNING:** Gas can expand. Do not fill the gas tank to the very top. Leave a minimum of 1.5 in open space. Gasoline and gas fumes are highly flammable. Do not fill the tank near an open flame. Always check for fuel spills.

### IMPORTANT:

- To ensure that the engine runs smoothly use only FRESH, UNLEADED GAS WITH AN OCTANE RATING OF 87 OR HIGHER.
- Never use an oil/gasoline mixture. Never use old gas.
- Avoid getting dirt or water in the fuel tank.
- Gas can age in the tank and make it hard to start up the generator in the future.
- Never store generator for extended periods of time with fuel in the tank.



POWERING EVERYONE...  
***ANYWHERE!***



# STARTING THE ENGINE

If this is not your first time using the engine there are still steps you should take to prepare it for operation each time you use it.

**IMPORTANT:** At this point you should be familiar with the procedures described in the first portion of this section entitled “ENGINE SETUP” If you have not yet read this section, go back and read it now.

# BEFORE YOU START YOUR ENGINE

## Step 1 - Check the Oil



### Check the oil

The engine is equipped with an automatic shutoff to protect it from damage due to low oil. Nonetheless, you should check the oil level of the engine before each use to ensure that the engine crankcase has a sufficient amount.

To check the oil level:

- a. Make sure the engine is on a level surface.
- b. Unscrew the oil filler/dipstick cap.
- c. With a dry cloth, wipe the oil off of the stick on the inside of the cap.
- d. Insert the dipstick as if you were replacing the cap and then remove it again. There should now be oil on the stick. If there is no oil on the stick, or oil only at the very end of the stick, you should add oil until the engine crankcase is filled (see “Adding Oil” portion of the “Maintenance” section).
- e. Be sure to replace the cap when finished checking oil.



<b>Model Number</b>	XP18HP
<b>Engine Oil Capacity</b>	37.2 fl. oz (1.1L)

## Step 2 - Check the Fuel Level



### Check fuel level

Before starting your engine, check to see that there is sufficient gasoline in the fuel tank. The gasoline level should always be under the red fuel level indicator located on the bottom of the fuel filter cup.



**WARNING:** Gasoline and gasoline fumes are highly flammable.

- Do not fill the tank near an open flame.
- Always allow the engine to cool for several minutes before refueling.
- DO NOT overfill the fuel tank. Fuel expands when shaken or heated. ALWAYS leave 1½" space or more at the top of the tank.
- ALWAYS use fresh fuel or stabilized fuel. Old gasoline (older than 30 days) can cause permanent damage to the fuel system.
- Always check for fuel spills.

# STARTING THE ENGINE (CONTINUED)

## Starting the Engine



### 1. Move fuel valve to ON

The gas valve is located above the carburetor bowl. Move the gasoline fuel valve lever all the way to the right-hand position to allow gasoline to flow to the engine carburetor.



### 2. Move choke lever to ON

The choke lever is located above the gas valve. Move the choke lever to the left-hand side to the "ON" position to start. Please note that if the engine is hot, turning the choke on is unnecessary.



### 3. Adjust the throttle lever

The throttle lever is located above and to the right of the choke lever. Adjust the throttle lever to the low speed position.



### 4. Turn engine switch to ON

Turn the engine switch to the "ON" position to allow the engine to start.



## 5. Pull the recoil start handle

Pull the recoil handle slowly until resistance is felt, then quickly pull the recoil handle until fully extended. Continue this step until the engine starts as needed.



**CAUTION:** Release the recoil handle only after the cord has retracted. Releasing the recoil handle while extended may cause harm to yourself or your equipment.



## 6. Move the choke lever to RUN

After allowing the engine to preheat, move the choke lever to the right-hand side to the "RUN" position to steady the idle speed and run the engine.



## 7. Adjust the throttle lever

Adjust the throttle lever to the proper position for the desired speed and the engine is ready for use.



POWERING EVERYONE...  
***ANYWHERE!***





# MAINTENANCE AND CARE

Proper maintenance and storage of your engine is essential to ensure trouble free use of your engine when you need it.

By following the maintenance and care requirements, you can keep your engine running smooth and efficient for years to come.

# MAINTENANCE AND CARE

Proper routine maintenance of your generator is essential for safe, economical, and trouble-free operation. It will also help reduce air pollution.



**WARNING:** Improper maintenance, or failure to correct a problem before operation, can cause a malfunction in which you can be seriously injured or killed. Always follow the inspection, maintenance recommendations, and schedules in this instruction manual.

- Make sure the engine is off before you begin any maintenance or repairs.
- Let the engine and exhaust system cool before touching.
- To reduce the possibility of fire or explosion, be careful when working around gasoline. Use only a nonflammable solvent, not gasoline, to clean parts. Keep cigarettes, sparks, and flames away from all fuel-related parts.

## Maintenance Schedule

Remember that this schedule is based on the assumption that your machine will be used for its designed purpose. Sustained high-load, high-temperature operation, or use in unusually wet or dusty conditions, will require more frequent service.

SERVICE	EVERY USE	1ST MO. OR 8 HRS. (BREAK IN)	EVERY 3 MO. OR 50 HRS. OF HEAVY USE	EVERY 6 MO. OR 100 HRS. OF NORMAL USE	EVERY 12 MO. OR 300 HRS.	EVERY 3 YRS. OR 500 HRS.
ENGINE OIL	CHECK	CHANGE	CHANGE	CHANGE		
AIR CLEANER	CHECK	CHECK	CHANGE	CHANGE		
SPARK PLUG			CLEAN / ADJUST	CLEAN / ADJUST		
SPARK ARRESTOR	CHECK				CLEAN	
IDLE SPEED					CHECK / ADJUST	
VALVE CLEARANCE					CHECK / ADJUST	
FUEL TUBE	CHECK				CHECK / REPLACE	
FUEL TANK / FILTER					CLEAN	
COMBUSTION CHAMBER						CLEAN

## Break-In Period

As the best practice for any new combustion motor it's recommended to perform the break in procedure as follows:

- Run the engine for the first 6-8 hours on conventional oil, then change the oil. After the break-in period synthetic oil may be used.
- During the break in period of the first 6-8 hours keep the engine speed under 50% for optimal results.
- Check and clean the air filter if necessary after the break-in period.

## Maintenance Log

As a best practice it's recommended to keep a log of the engine hours and maintenance to ensure your engine is always operating to its full potential.

Date	Engine Hours	Maintenance Performed

## Checking the Oil



### Check the oil

The engine is equipped with an automatic shutoff to protect it from damage due to low oil. Nonetheless, you should check the oil level of the engine before each use to ensure that the engine crankcase has a sufficient amount.

To check the oil level:

- a. Make sure the engine is on a level surface.
- b. Unscrew the oil filler/dipstick cap.
- c. With a dry cloth, wipe the oil off of the stick on the inside of the cap.
- d. Insert the dipstick as if you were replacing the cap and then remove it again. There should now be oil on the stick. If there is no oil on the stick, or oil only at the very end of the stick, you should add oil until the engine crankcase is filled (see “Adding Oil” portion of the “Maintenance” section).
- e. The oil will be visible in the oil fill spout when full.
- f. Be sure to replace the cap when finished checking oil.



<b>Model Number</b>	XP18HP
<b>Engine Oil Capacity</b>	37.2 fl. oz (1.1 L)

# Changing the Oil



**CAUTION:** Worn out or dirty oil does not cool the engine properly and can lead to catastrophic engine damage.

In addition to regular oil changes, it is necessary to drain the oil from the crankcase if it has become contaminated with water or dirt.



## 1. Remove drain plug

Using a 12 mm hex wrench, unscrew the oil drain plug, which is located on the crankcase underneath the oil filler/ dipstick cap.

Allow all the oil to drain from the engine.



## 2. Drain oil

Drain oil into an approved oil disposal container. Contact your local auto parts store for information on oil disposal.



## 3. Replace drain plug

Replace the oil drain plug and tighten with a 12 mm hex wrench.

## Changing the Air Filter

### MAINTAIN AIR FILTER

Clean air filter after every 50 hours of use  
(every 10 hours in unusually dusty conditions)

Wash filter element with household detergents.  
Wipe out dust from air filter housing before  
replacing filter element.

Never clean with a brush

Routine maintenance of the air cleaner helps maintain proper airflow to the carburetor. Check that the air cleaner is free of excessive dirt after every use.



**CAUTION:** Improper maintenance may cause less air to enter the engine or dirty air to enter the engine causing overheating and engine wear.



### 1. Remove filter cover wing nut

Remove the wing nut located on the top of the air filter cover.



### 2. Remove filter cover

Remove the plastic air filter cover by lifting the cover upwards to expose the air filter element.



### 3. Remove old filter element

Remove the wing nut on top of the air filter element and slide filter element off center bolt. This filter is paper and is not reusable. Please call 1-844-DUROMAX to order a replacement filter for your engine.



## 4. Replace new filter element

Slide new filter element over center bolt, and replace wing nut. Tighten wing nut hand tight to keep filter in place.

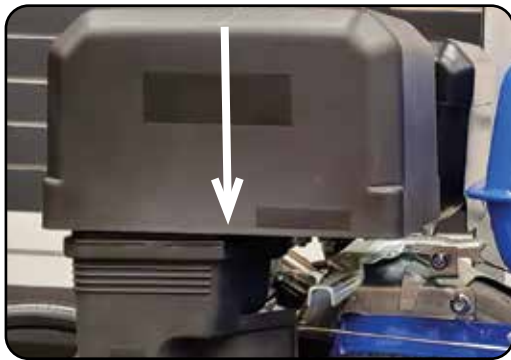

## 5. Replace filter cover

Replace plastic air filter cover over the air filter base.



## 6. Secure filter cover

Fasten the air filter cover with the air filter cover wing nut and tighten about hand tight.

# MAINTENANCE AND CARE (CONTINUED)

## Spark Plug Maintenance



The spark plug is important for proper engine operation. A good spark plug should be intact, free of deposits, and properly gapped.



**CAUTION:** Improper maintenance may cause reduced fuel economy, misfires, trouble starting, or damage to the spark plug threads.



### 1. Remove spark plug cap

Pull on the spark plug cap to remove it.



### 2. Remove spark plug

Unscrew the spark plug from the engine using the spark plug wrench included with this product.



### 3. Inspect spark plug

Visually inspect the spark plug. If it is cracked or chipped, discard and replace it with a new spark plug. We recommend using an F6RTC spark plug such as NGK BPR6ES.





## 4. Measure plug gap

Measure the plug gap with a gauge. The gap should be 0.7-0.8 mm (0.028-0.031 in).



## 5. Clean and re-gap

If you are re-using the spark plug, use a wire brush to clean any dirt from around the spark plug base and then re-gap the spark plug.



## 6. Install spark plug

Screw the spark plug back into its place on the engine using the spark plug wrench.



## 7. Replace spark plug cap

Replace the spark plug cap.

## Emptying the Gas Tank



If you have been using gasoline in your engine, before storing your engine for extended periods of time you should drain your engine fuel tank of gasoline.



**CAUTION:** Do not store fuel from one season to another. Gasoline sold at the pump today contains additives such as ethanol that even when stored properly may damage the fuel system components.

### 1. Shut fuel valve OFF

Turn the fuel valve to the "OFF" position.



### 2. Remove carburetor drain bolt

Remove the outward angled bolt that is located on the bottom of the carburetor.



### 3. Place funnel below drain port

Place funnel with container to catch the gasoline under the drain port location.





#### 4. Turn fuel valve ON and drain

Turn the fuel valve to "ON" and allow gasoline to drain into the container until the gas tank is empty.



#### 5. Shut fuel valve OFF

Once the gasoline is fully drained, move the fuel valve back to the "OFF" position.



#### 6. Replace carburetor drain bolt

Reinstall the carburetor drain bolt.



#### 7. Store emptied gasoline

Store the emptied gasoline in a suitable place and add fuel stabilizer to keep fuel fresh and usable.

## Storing the Engine for Same Day Use



### 1. Run the engine

Allow the engine to run for 3-5 minutes.



### 2. Turn engine switch to OFF

Move the engine switch to the "OFF" position to shut the engine off.



### 3. Store engine

After the engine shuts off and cools, then you can store the engine.



**CAUTION:** Do not obstruct any ventilation openings and keep the engine in a cool dry area.

## Storing the Engine for Use Within 30 Days



### 1. Run the engine

Allow the engine to run for 3-5 minutes.



### 2. Shut fuel valve OFF and run dry

Shut the fuel valve "OFF" and allow engine to run until it stalls out.



### 3. Turn the engine switch OFF

Move the engine switch to the "OFF" position to shut the engine off.



### 4. Add fuel stabilizer and store

Add fuel stabilizer to gas remaining in tank, and store the engine.

## Storing the Engine for Longer Than 30 Days



### 1. Run the engine

Allow the engine to run for 3-5 minutes.



### 2. Shut fuel valve OFF and run dry

Shut the fuel valve "OFF" and allow engine to run until it stalls out.



### 3. Turn the engine switch OFF

Move the engine switch to the "OFF" position to shut the engine off.



### 4. Empty the gas tank

Fully drain your gas tank as shown in "Emptying the Gas Tank" on page 34-35.



## 5. Remove spark plug

Remove spark plug as shown in “Spark Plug Maintenance” on page 32.



## 6. Add oil to cylinder

Add 2 tablespoons of 10W-30 motor oil directly into the spark plug hole, and pull the recoil to lubricate cylinder. After lubricating cylinder reinstall the spark plug as shown in “Spark Plug Maintenance” on page 33.



## 7. Store engine

The engine is ready to be stored in a cool dry area.



**CAUTION:** Do not obstruct any ventilation openings and keep the engine in a cool dry area.



POWERING EVERYONE...  
***ANYWHERE!***





# SPECIFICATIONS

A quick reference to useful information on your new DuroMax engine, please see this section for more details on this engine's specifications.



POWERING EVERYONE...  
***ANYWHERE!***

# SPECIFICATIONS

<b>Displacement</b>	439cc	
<b>Fuel Type</b>	≥87 octane, ≤10% ethanol, unleaded gasoline	
<b>Dry Weight</b>	77 lbs	
<b>Maximum Torque</b>	27 ft. lb @ 2500 RPM	
<b>Compression Ratio</b>	8.5:1	
<b>Bore X Stroke</b>	92 mm x 66 mm	
<b>Engine Oil Capacity</b>	37.2 oz.	
<b>Fuel Tank Capacity</b>	1.7 Gal.	
<b>Lowest Idling Speed</b>	1800 RPM ± 300 RPM	
<b>Dimensions</b>	LENGTH	19.5 in.
	WIDTH	17.5 in.
	HEIGHT	19.3 in.
<b>Engine Type</b>	4-Stroke OHV Forced-Air	
<b>Ignition System</b>	Non-Contact Transistor	
<b>Lubrication Mode</b>	Splash	
<b>Starting Type</b>	Recoil	
<b>Shaft Rotation</b>	Counter-Clockwise	
<b>Shaft Size</b>	1" Diameter, 2-3/4" Long, 1/4" Keyway	
<b>Shaft End</b>	3/8" Size 24 UNF - Drilled and Tapped	
<b>Center of Shaft to Base</b>	5"	
<b>Bearing Type</b>	Stainless steel ball bearing	
<b>Cylinder Sleeve Type</b>	Cast iron sleeve	
<b>Fuel Delivery System</b>	Carburetor	

# SPECIFICATIONS (CONTINUED)

## Adjustment, Torque, and Timing Specifications

### Adjustment Specification

<b>Spark Plug Clearance</b>	.027-.031 in. (0.7-0.8 mm)
<b>Spark Plug Type</b>	F6RTC (Torch), F6TC (Torch), BPR6ES (NGK), RN9YC (Champion), WR7DC (Bosch), W20EPR-U (Denso)
<b>Valve Clearance (Cold)</b>	Intake: .006 in $\pm$ .001 in. (0.15mm $\pm$ 0.02mm) Exhaust: .008 in $\pm$ .001 in. (0.20mm $\pm$ 0.02mm)
<b>Carburetor Idling</b>	1800 $\pm$ 300 rpm

### Torque Value

<b>Cylinder head bolt</b>	29.50 $\pm$ 2.21 ft. lb (40 $\pm$ 3 N·m)
<b>Flywheel bolt</b>	70 $\pm$ 5.9 ft. lb (95 $\pm$ 8 N.m)
<b>Crankcase bolt</b>	18 ft. lb. (24 NM)
<b>Tie-rod bolt</b>	9 ft. lb. (12 NM)

### Timing Distribution

<b>Intake Open (Timing)</b>	BTDC 10°
<b>Intake Closed (Timing)</b>	ABCD 20°
<b>Exhaust Open (Timing)</b>	BBDC 30°
<b>Exhaust Closed (Timing)</b>	ATDC 10°

# Engine Diagrams

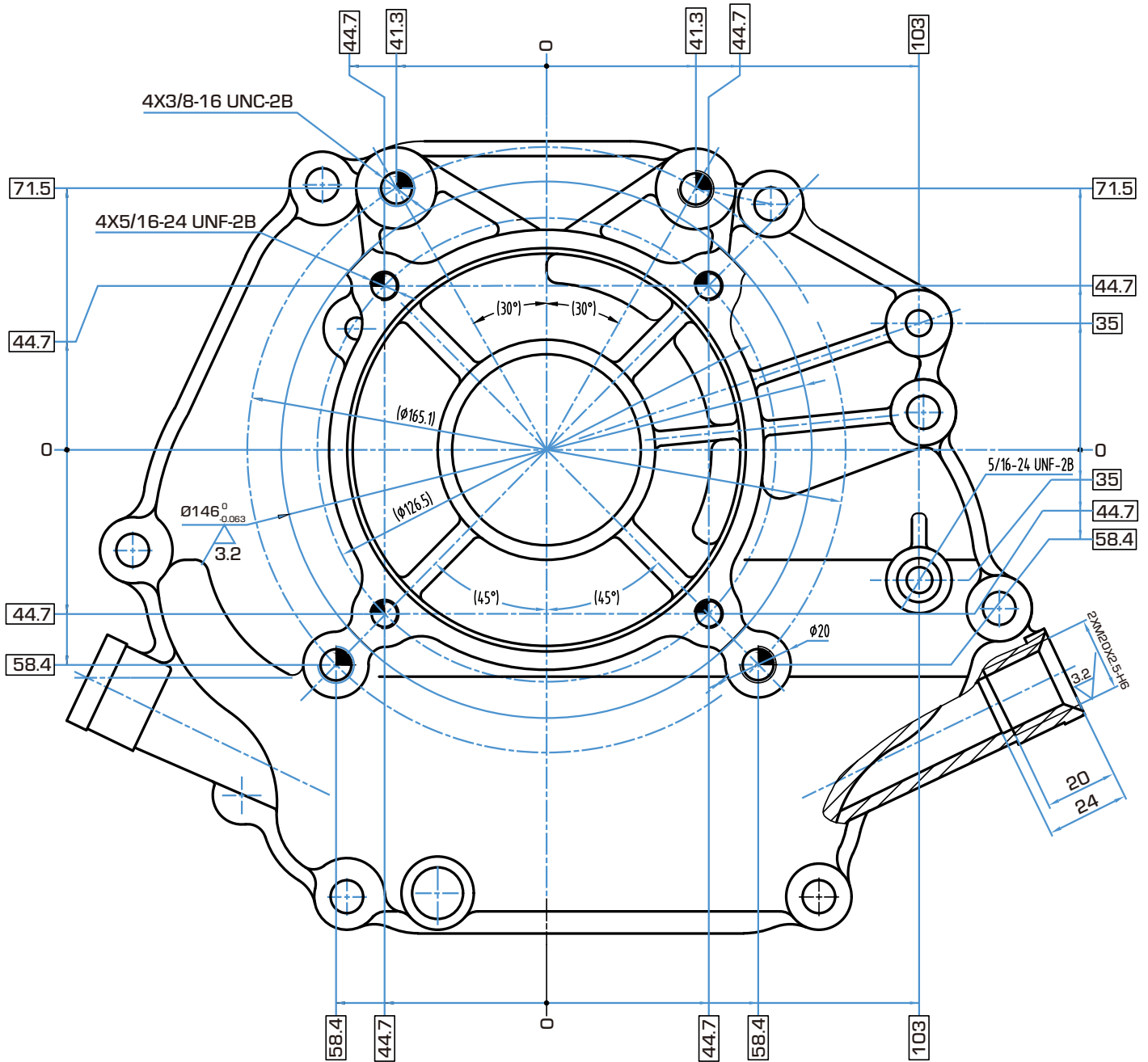

# SPECIFICATIONS (CONTINUED)

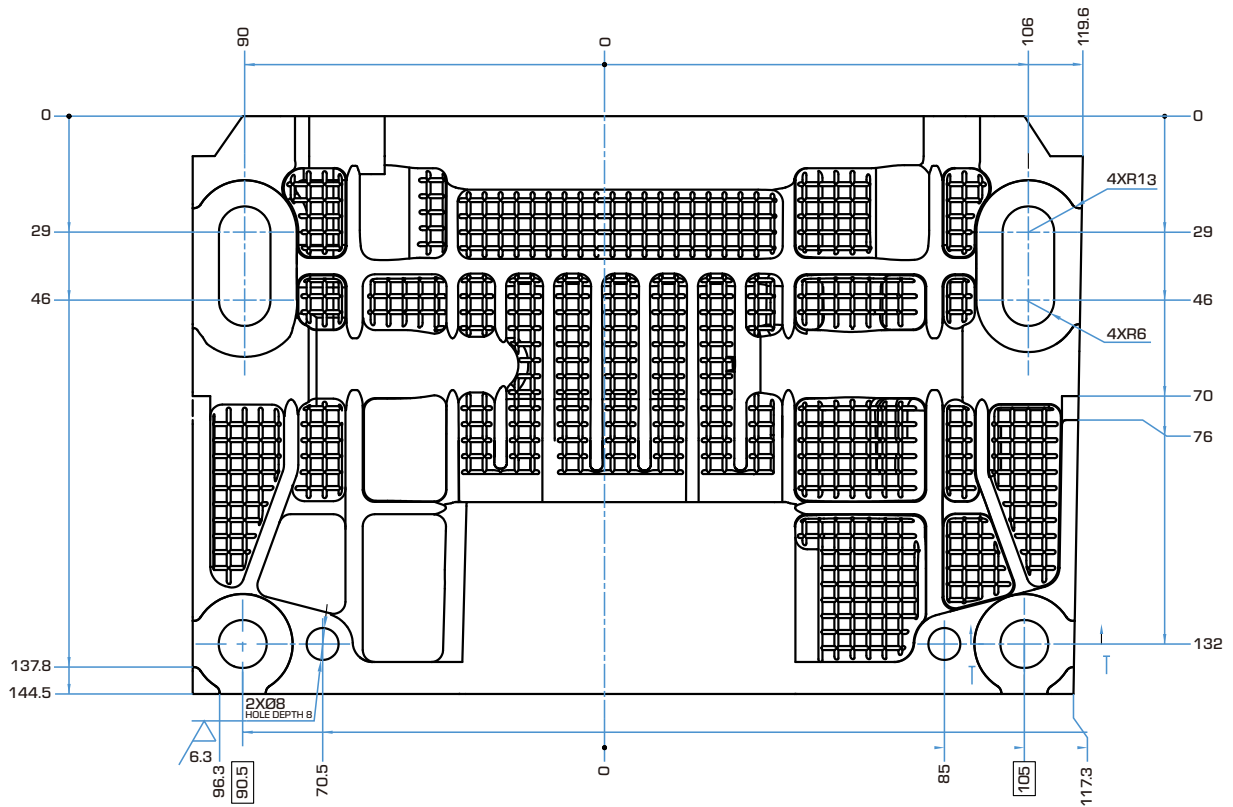
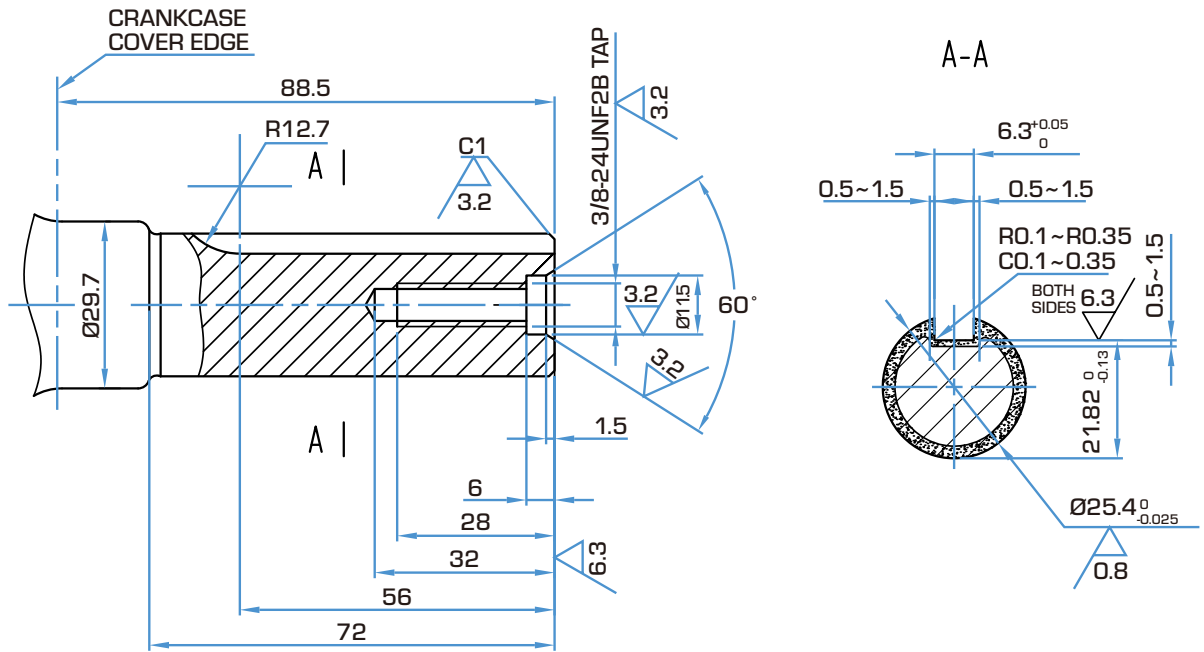

# Wiring Diagram

Bl	Black
Y	Yellow
G	Green

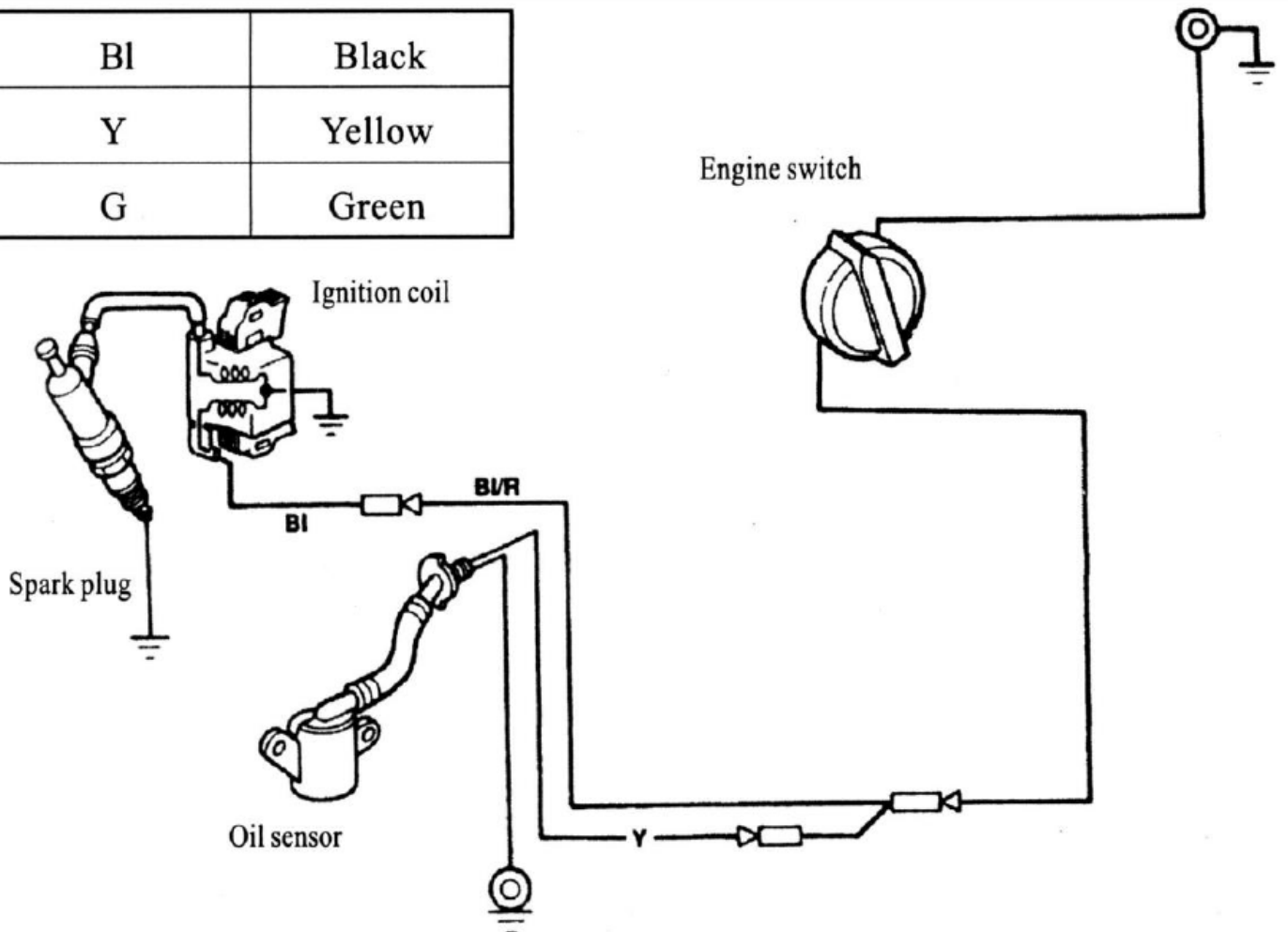



POWERING EVERYONE...  
***ANYWHERE!***





# TROUBLESHOOTING

This section of the manual is to help you troubleshoot problems with your engine.



POWERING EVERYONE...  
***ANYWHERE!***

# TROUBLESHOOTING

Mode	Description	Solution
<b>Engine will not start</b>	Engine switch is "OFF"	Set engine switch to "ON"
	Fuel valve is "OFF"	Turn fuel valve to "ON"
	Choke is open	Close the choke
	Engine is out of fuel	Add fuel
	Fuel is old or contaminated	Change fuel
	Spark plug is dirty	Clean spark plug
	Spark plug is broken	Replace spark plug
	Engine is not level	Move engine to a level surface
	Oil is low	Add/ change oil
<b>Engine starts, but shuts off after running for a short time.</b>	Oil level is low	Add change oil
	Fuel is old or contaminated	Change fuel
	Engine is on incline exceeding 15°	Disconnect low oil sensor



POWERING EVERYONE...  
***ANYWHERE!***



# WARRANTY

This section of the manual is to help you understand your warranty.

# WARRANTY

## **3-year Warranty**

All DuroMax Power Equipment warrant the original purchasers to a 3-year Parts Warranty (Residential

Use ONLY: Unusually heavy or commercial use is covered for a period of 1-year) in the event of failure due to defects in electrical or mechanical components. Freight on any items submitted for replacement or repair under the Warranty are the responsibility of the equipment owner. This warranty is non-transferable and only valid to the original purchaser.

## **Warranty Exclusions**

The DuroMax Power Equipment warranty does not cover repairs or returns when the fault is: Normal Wear and Tear, Installation Use or Maintenance Services, Cosmetic defects, Accessories, Failures due to acts of God or Natural Disasters, or problems related to/from aftermarket or non-OEM parts.

## **Warranty Limitations**

DuroMax Power Equipment does not claim or hold any obligation to loss of time, freight charges, use of product, or any incidental damages from the use of this product. THIS WARRANTY IS IN LIEU OF ALL OTHER WARRANTIES, EXPRESSED OR IMPLIED.

## **U.S. FEDERAL AND CALIFORNIA EMISSIONS CONTROL WARRANTY STATEMENT**

### **YOUR WARRANTY RIGHTS AND OBLIGATIONS**

The U.S. Environmental Protection Agency (EPA), California Air Resources Board, and DuroMax Power Equipment are pleased to explain the emissions control system's warranty on your 2022/2023 small off-road engine.

In California, new small off-road engines must be designed, built, and equipped to meet the State's stringent anti-smog standards. DuroMax Power Equipment must warrant the emissions control system on your small off-road engine for the period listed below provided there has been no abuse, neglect, or improper maintenance of your small off-road engine leading to the failure of the emission control system.

Your emissions control system may include parts such as: carburetors or the fuel injection system, ignition system, catalytic converters, fuel tanks, fuel lines(for liquid fuel and fuel vapors), fuel caps, valves, filters, clamps, connectors, and other associated components. Also, included may be hoses, belts, sensors, and other emission-related assemblies.

Where a warrantable condition exists, DuroMax Power Equipment will repair your small off-road engine at no cost to you including diagnosis, parts, and labor.

### **MANUFACTURER'S WARRANTY COVERAGE:**

This emissions control system is warranted for two years. If any emissions-related part on your small off-road engine is defective, the part will be repaired or replaced by DuroMax Power Equipment.

## **OWNER'S WARRANTY RESPONSIBILITIES:**

As the small off-road engine owner, you are responsible for performance of the required maintenance listed in your owner's manual. DuroMax Power Equipment recommends that you retain all receipts covering maintenance on your small off-road engine, but DuroMax Power Equipment cannot deny warranty coverage solely for the lack of receipts or your failure to ensure the performance of all scheduled maintenance.

As the small off-road engine owner, you should be aware that the DuroMax Power Equipment may deny you warranty coverage if your small off-road engine or a part has failed due to abuse, neglect, or improper maintenance or unapproved modifications.

You are responsible for presenting your small off-road engine to a DuroMax Power Equipment distribution center or service center as soon as the problem exists. The warranty repairs shall be completed in a reasonable amount of time, not to exceed 30 days.

If you have any questions regarding your warranty coverage, contact us at 844-387-6629 or email [support@duromaxpower.com](mailto:support@duromaxpower.com).

## **DEFECTS WARRANTY REQUIREMENTS:**

The warranty period begins on the date the engine or equipment is delivered to an ultimate purchaser and extends for a period of Two Years.

### **GENERAL EMISSIONS WARRANTY COVERAGE:**

DuroMax Power Equipment warrants to the ultimate purchaser and each subsequent owner that the engine or equipment is:

1. Designed, built, and equipped to conform with all applicable regulations adopted by the Air Resources Board; and
2. Free from defects in materials and workmanship that causes the failure of a warranted part for a period of two years.

The warranty on emissions-related parts will be interpreted as follows:

1. Any warranted part that is not scheduled for replacement as required maintenance in the Owner's Manual must be warranted for the warranty period stated above. If any such part fails during the period of warranty coverage, it must be repaired or replaced by DuroMax Power Equipment according to Subsection (4) below. Any such part repaired or replaced under the warranty must be warranted for a time not less than the remaining warranty period.
2. Any warranted part that is scheduled only for regular inspection in the Owner's Manual must be warranted for the warranty period stated above. A statement in such written instructions to the effect of "repair or replace as necessary" shall advise owners of the warranty coverage for emission related parts. Replacement within the warranty period is covered by the warranty and will not reduce the period of warranty coverage. Any such part repaired or replaced under warranty must be warranted for a time not less than the remaining warranty period.
3. Any warranted part that is scheduled for replacement as required maintenance in the Owner's Manual must be warranted for the period prior to the first scheduled replacement point for that part. If the part fails prior to the first scheduled replacement, the part must be repaired or replaced by the engine manufacturer according to Subsection (4) below. Any such part repaired or replaced

# WARRANTY (CONTINUED)

under warranty must be warranted for a time not less than the remainder of the period prior to the first scheduled replacement point for the part.

4. Repair or replacement of any warranted part under the warranty must be performed at no charge to the owner at a warranty station.
5. Notwithstanding the provisions of Subsection (4) above, warranty services or repairs must be provided at all manufacturer distribution centers that are franchised to service the subject engines.
6. The owner must not be charged for diagnostic labor that leads to the determination that a warranted part is in fact defective, provided that such diagnostic work is performed at a warranty station.
7. The manufacturer is liable for damages to other engine components proximately caused by a failure under warranty of any warranted part.
8. Throughout the emission control system's warranty period stated above, the manufacturer must maintain a supply of warranted parts sufficient to meet the expected demand for such parts and must obtain additional parts if that supply is exhausted.
9. Manufacturer-approved replacement parts that do not increase the exhaust or evaporative emissions of the engine or emissions control system must be used in the performance of any warranty maintenance or repairs and must be provided without charge to the owner. Such use will not reduce the warranty obligations of DuroMax Power Equipment.
10. Add-on or modified parts that are not exempted by the Air Resources Board may not be used. The use of any non-exempted add-on or modified parts will be grounds for disallowing a warranty claim made in accordance with this Article. DuroMax Power Equipment will not be liable under this Article to warrant failures of warranted parts caused by the use of an add-on or modified part.
11. DuroMax Power Equipment shall provide any documents that describe warranty procedures or policies within five working days of request by the Executive Officer.

## **Exhaust Emission Warranty Parts List.**

1. Fuel Metering System
  - i. Carburetor and internal parts (and/or pressure regulator or fuel injection system).
  - ii. Air/fuel ratio feedback and control system.
  - iii. Cold start enrichment system.
2. Air Induction System
  - i. Controlled hot air intake system.
  - ii. Intake manifold.
3. Ignition System
  - i. Spark Plugs.
  - ii. Magneto or electronic ignition system.
  - iii. Spark advance/retard system.
4. Air Injection System
  - i. Air pump or pulse valve.
  - ii. Valves affecting distribution of flow.
  - iii. Distribution manifold.



## 5. Catalyst or Thermal Reactor System

i. Catalytic converter.

ii. Thermal reactor.

iii. Exhaust manifold.

## 6. Particulate Controls

7. Traps, filters, precipitators, and any other device used to capture particulate emissions.

8. Electronic controls.

9. Vacuum, temperature, and time sensitive valves and switches.

10. Hoses, belts, connectors, and assemblies.

## **Evaporative Emission Warranty Part List**

1. Fuel Tank

2. Fuel Cap

3. Fuel Line (for liquid fuel and fuel vapors)

4. Fuel Line Fittings

5. Clamps\*

6. Pressure Relief Valves\*

7. Control Valves\*

8. Control Solenoids\*

9. Electronic Controls\*

10. Vacuum Control Diaphragms\*

11. Control Cables\*

12. Control Linkages\*

13. Purge Valves\*

14. Gaskets\*

15. Liquid/Vapor Separator

16. Carbon Canister

17. Canister Mounting Brackets

18. Carburetor Purge Port Connector

\* Note: As they relate to the evaporative emission control system.

DuroMax Power Equipment will furnish with each new engine written instructions for the maintenance and use of the engine by the owner

## CUSTOMER SERVICE

DuroMax Power Equipment is committed to ensuring that our products perform when they need to. Our generators are your lifeline in the event of an emergency. Should you have any problems, please contact our customer service department:

**DUROMAX POWER EQUIPMENT**  
**5800 Ontario Mills Parkway**  
**Ontario, CA 91764**

Customer Service: 844-DUROMAX  
Customer Service Hours: 8-5 pm PST Mon-Fri

Website: [www.duromaxpower.com](http://www.duromaxpower.com)  
Email: [customerservice@duromaxpower.com](mailto:customerservice@duromaxpower.com)







5800 Ontario Mills Parkway  
Ontario, CA 91764  
United States

844-DUROMAX