

ASSEMBLY INSTRUCTIONS
PROJECT : ANDREW
LOCATION : USA

drawing title date 18/10/2018 scale NTS

STEP 1



53x Jl.Uluwatu 2, Jimbaran-Bali-Indonesia
 Phone/fax: +62 361 8472 101
 info@pt-touchwood.com
 www.pt-touchwood.com

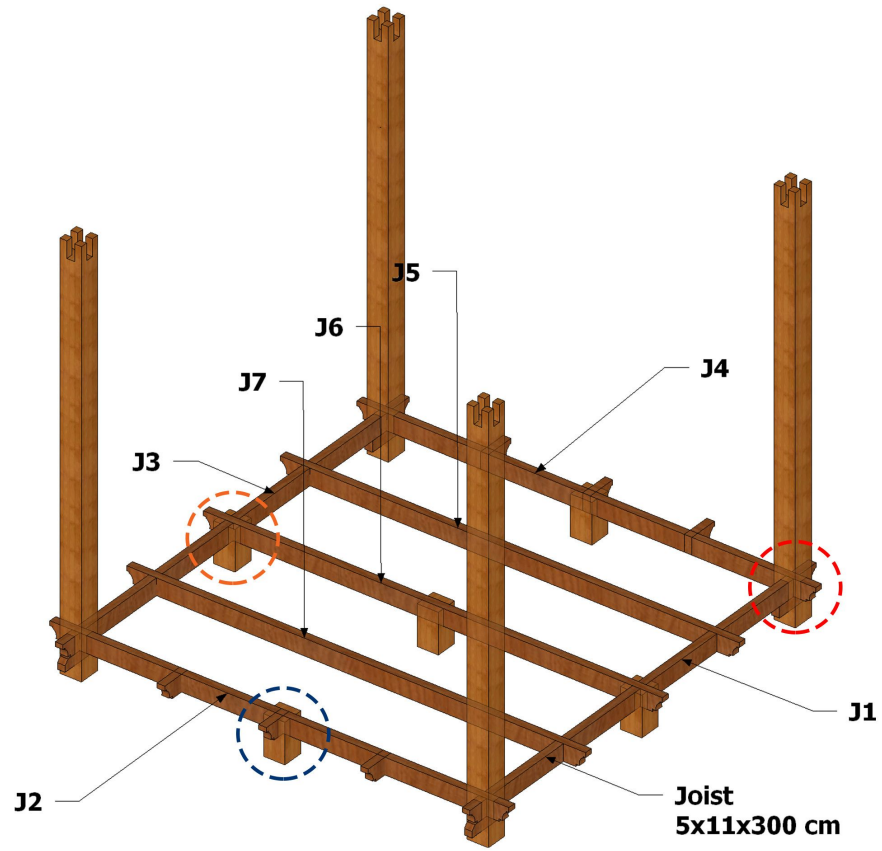

ASSEMBLY INSTRUCTIONS
PROJECT : ANDREW
LOCATION : USA

drawing title date 18/10/2018 scale NTS

STEP 2

53x Jl.Uluwatu 2, Jimbaran-Bali-Indonesia
 Phone/fax: +62 361 8472 101
 info@pt-touchwood.com
 www.pt-touchwood.com

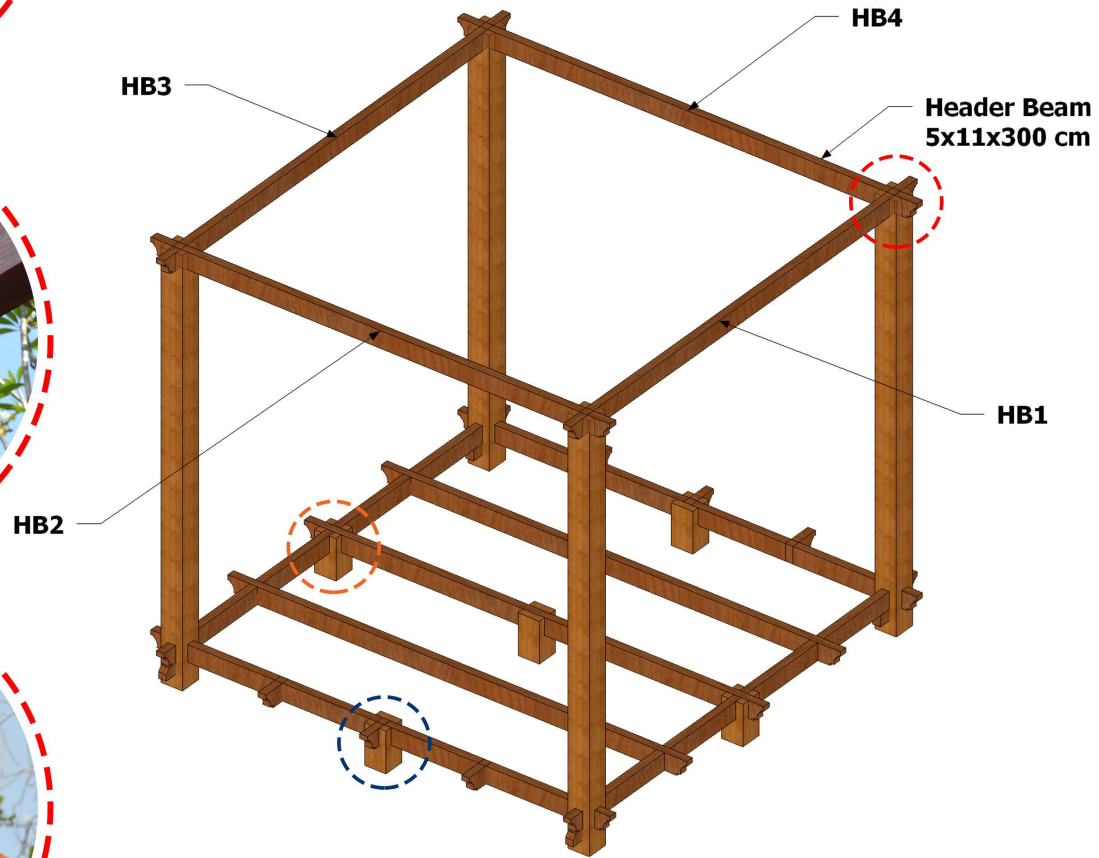

ASSEMBLY INSTRUCTIONS
PROJECT : ANDREW
LOCATION : USA

drawing title date 18/10/2018 scale NTS

STEP 3



53x Jl.Uluwatu 2, Jimbaran-Bali-Indonesia
Phone/fax: +62 361 8472 101
info@pt-touchwood.com
www.pt-touchwood.com

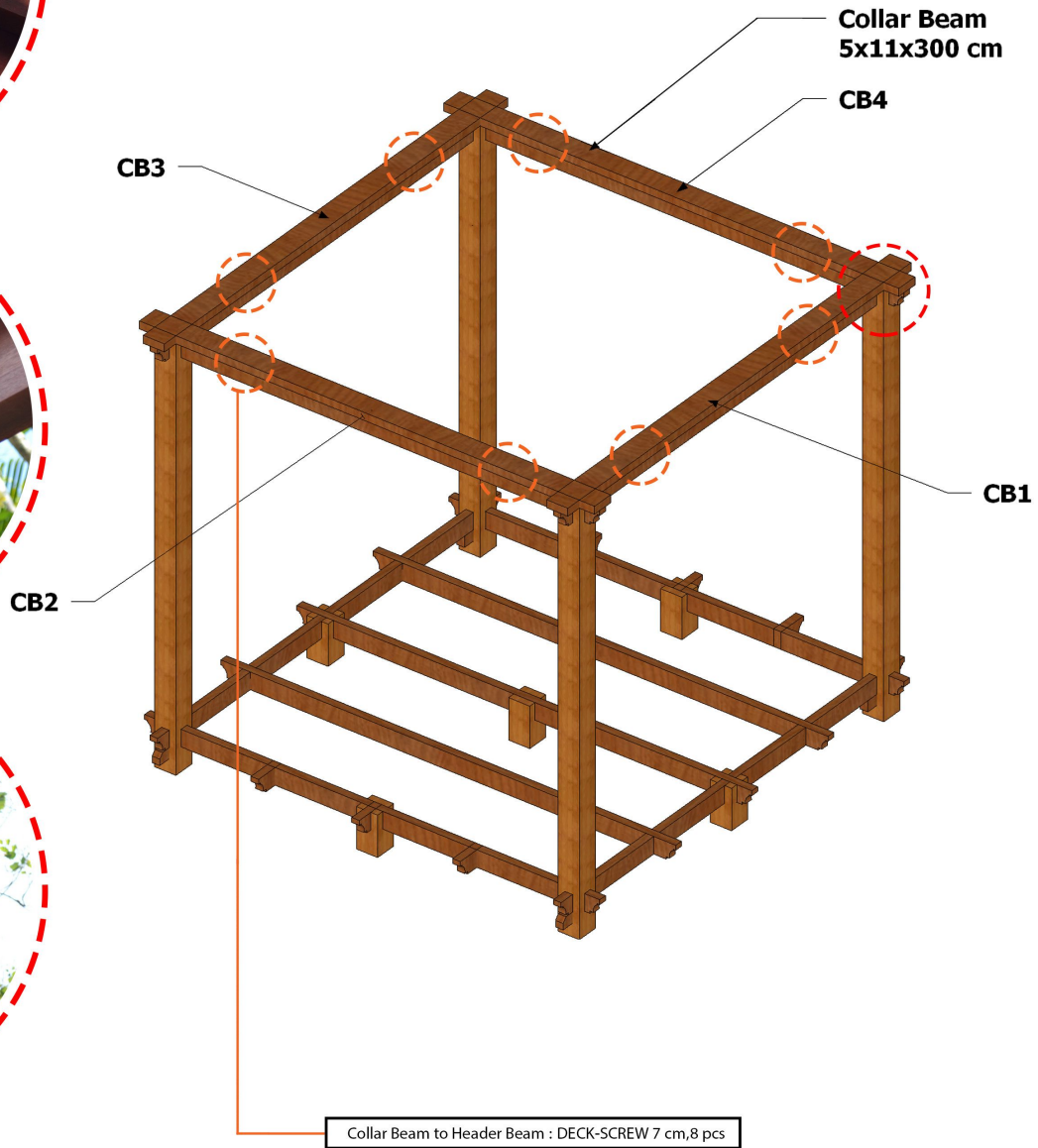

ASSEMBLY INSTRUCTIONS
PROJECT : ANDREW
LOCATION : USA

drawing title date 18/10/2018 scale NTS

STEP 4



53x Jl.Uluwatu 2, Jimbaran-Bali-Indonesia
 Phone/fax: +62 361 8472 101
 info@pt-touchwood.com
 www.pt-touchwood.com

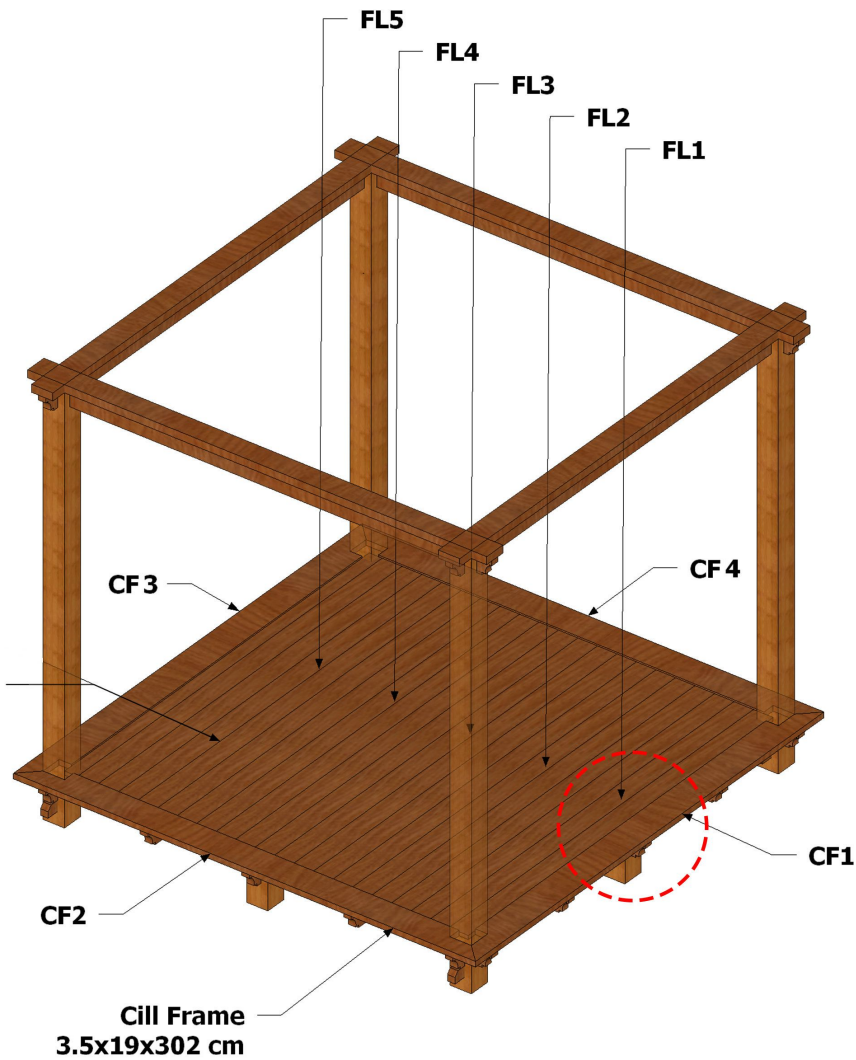
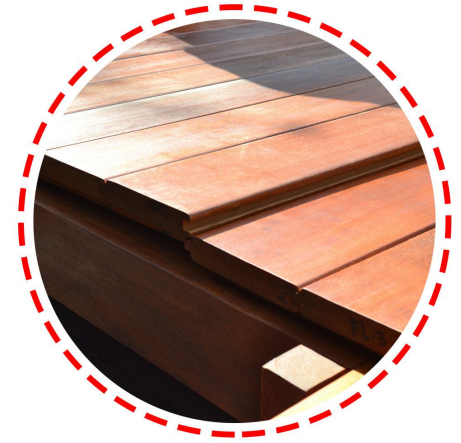

Flooring T&G
2.5 x 265 cm

ASSEMBLY INSTRUCTIONS
PROJECT : ANDREW
LOCATION : USA

drawing title date 18/10/2018 scale NTS

STEP 5

53x Jl.Uluwatu 2, Jimbaran-Bali-Indonesia
Phone/fax: +62 361 8472 101
info@pt-touchwood.com
www.pt-touchwood.com

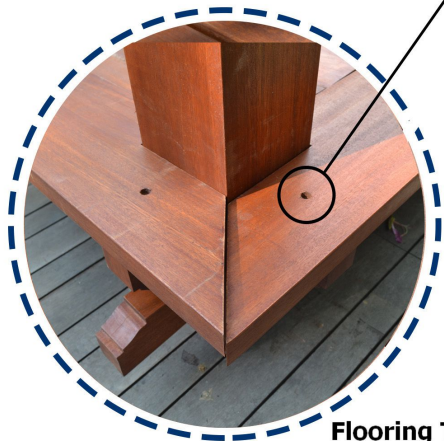
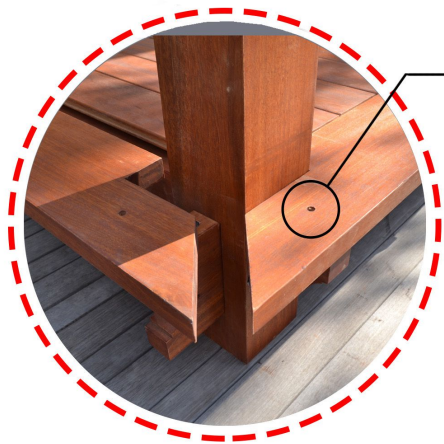

Cill Frame to Joist : SCREW 7 cm,12 pcs

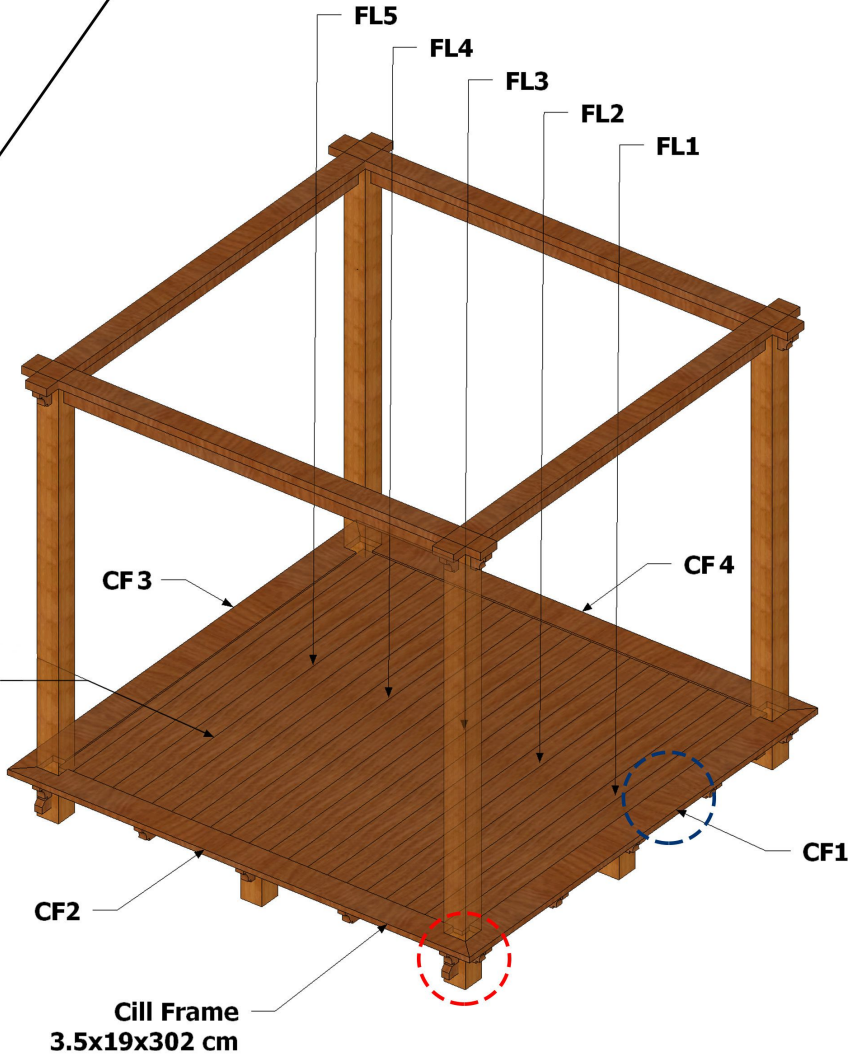

ASSEMBLY INSTRUCTIONS
PROJECT : ANDREW
LOCATION : USA

drawing title date 18/10/2018 scale NTS

STEP 5



53x Jl.Uluwatu 2, Jimbaran-Bali-Indonesia
 Phone/fax: +62 361 8472 101
 info@pt-touchwood.com
 www.pt-touchwood.com

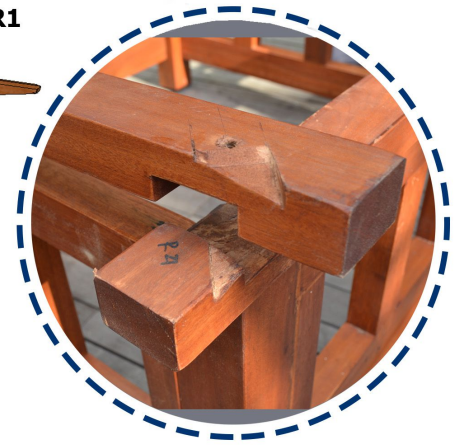
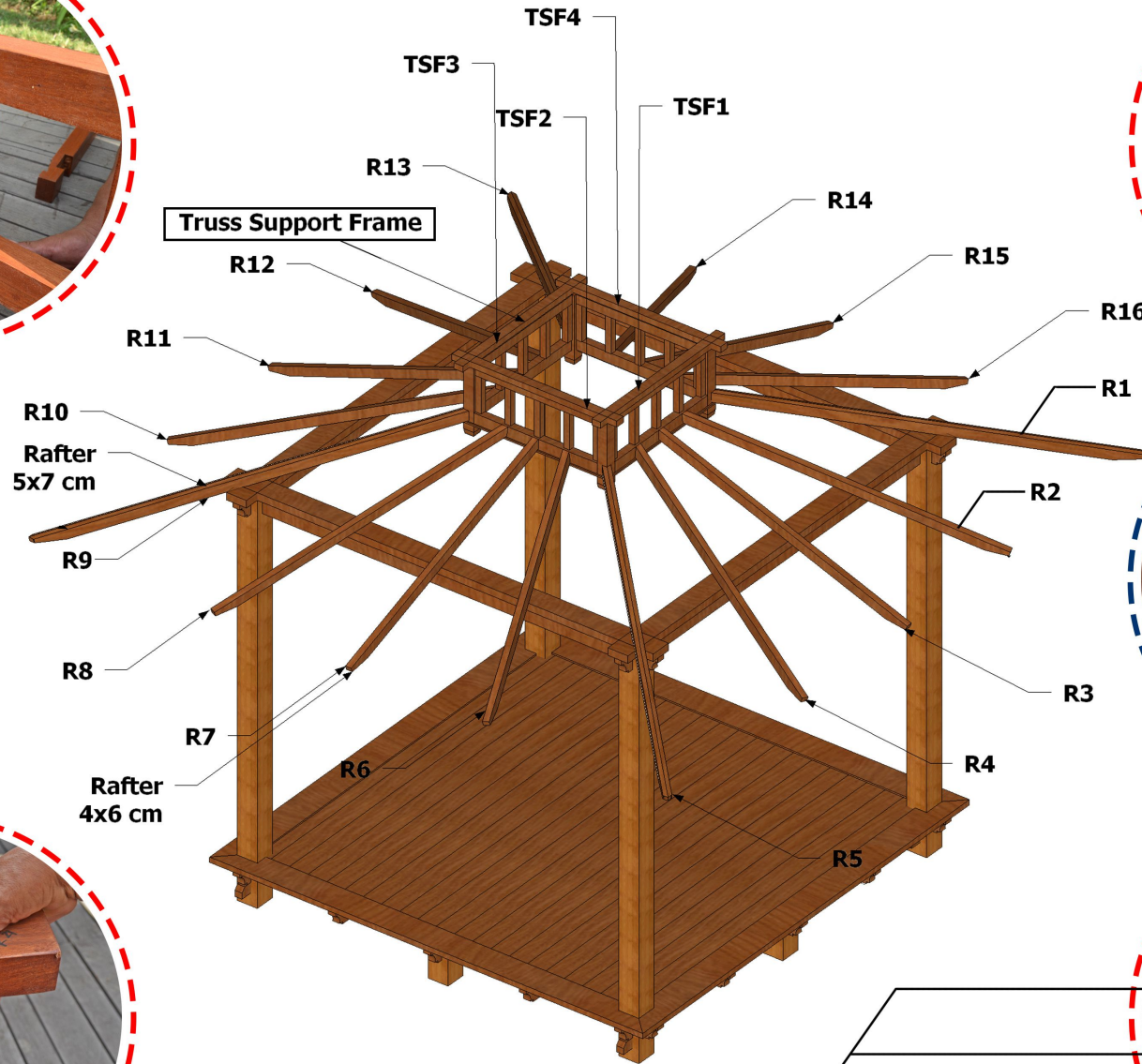

Truss Support Frame : DECK-SCREW 7 cm, 12 pcs

ASSEMBLY INSTRUCTIONS
PROJECT : ANDREW
LOCATION : USA

drawing title	date 18/10/2018	scale NTS
STEP 6		

53x Jl.Uluwatu 2, Jimbaran-Bali-Indonesia
Phone/fax: +62 361 8472 101
info@pt-touchwood.com
www.pt-touchwood.com

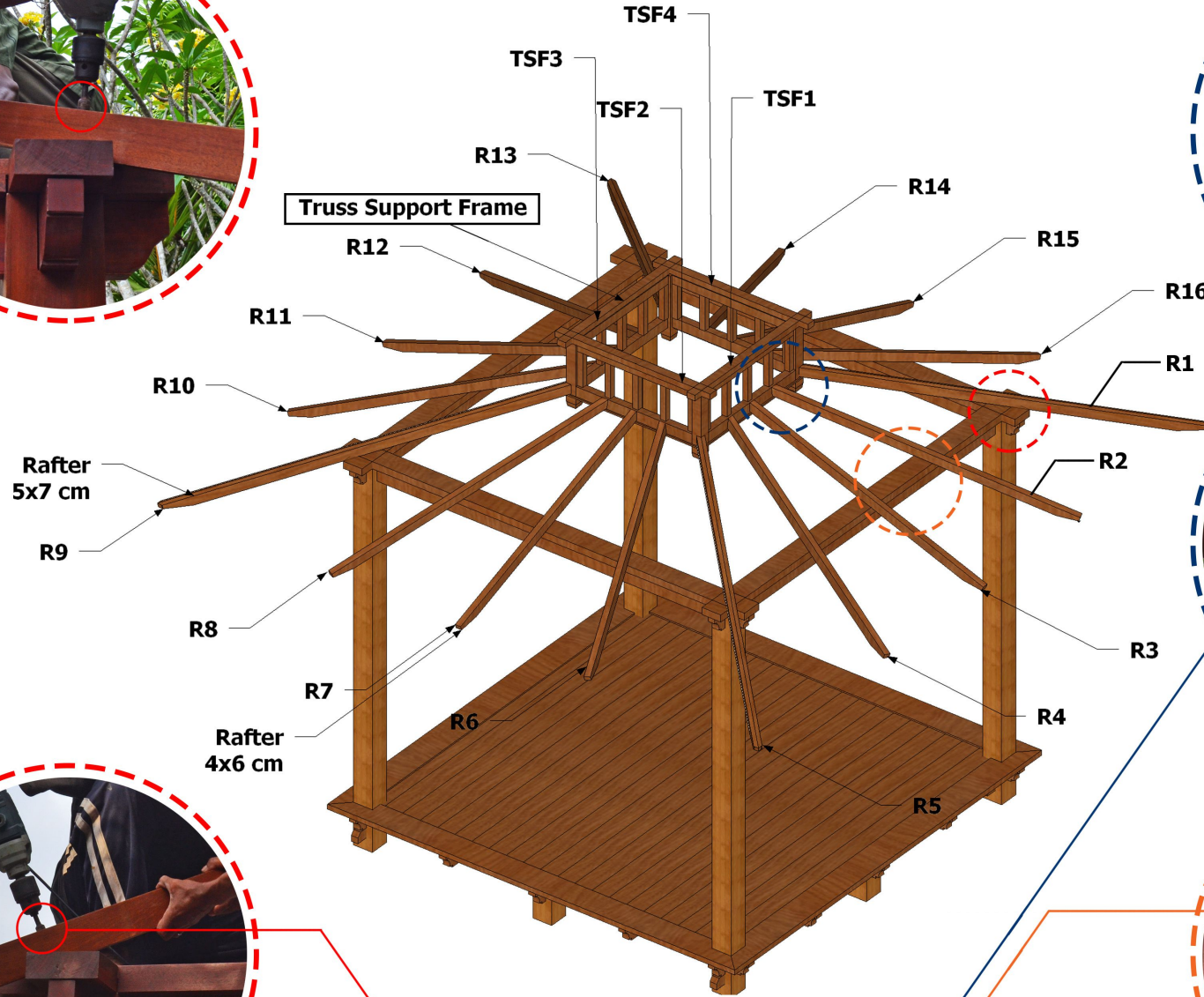
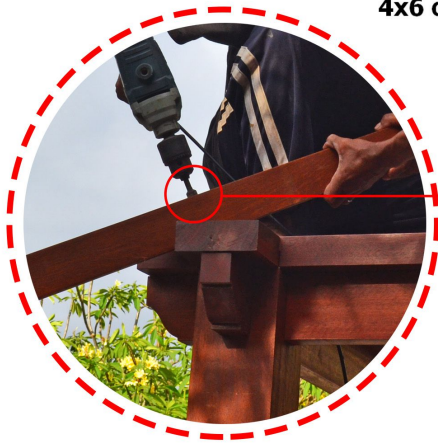
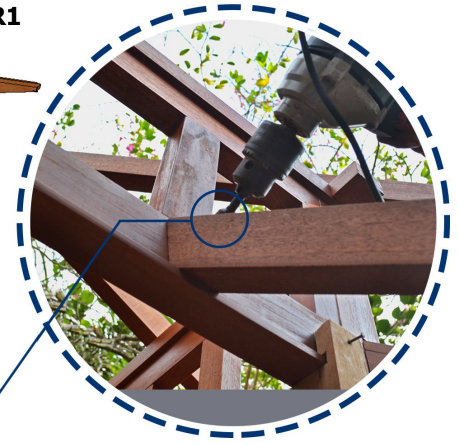

- Rafter to Truss Support Frame : DECK-SCREW 5 cm,16 pcs
- Rafter to Collar Beam : DECK-SCREW 7 cm,12 pcs
- Rafter HIP to Collar Beam : DECK-SCREW10 cm,4 pcs

ASSEMBLY INSTRUCTIONS
 PROJECT : ANDREW
 LOCATION : USA

drawing title date 18/10/2018 scale NTS
STEP 6

53x Jl.Uluwatu 2, Jimbaran-Bali-Indonesia
 Phone/fax: +62 361 8472 101
 info@pt-touchwood.com
 www.pt-touchwood.com

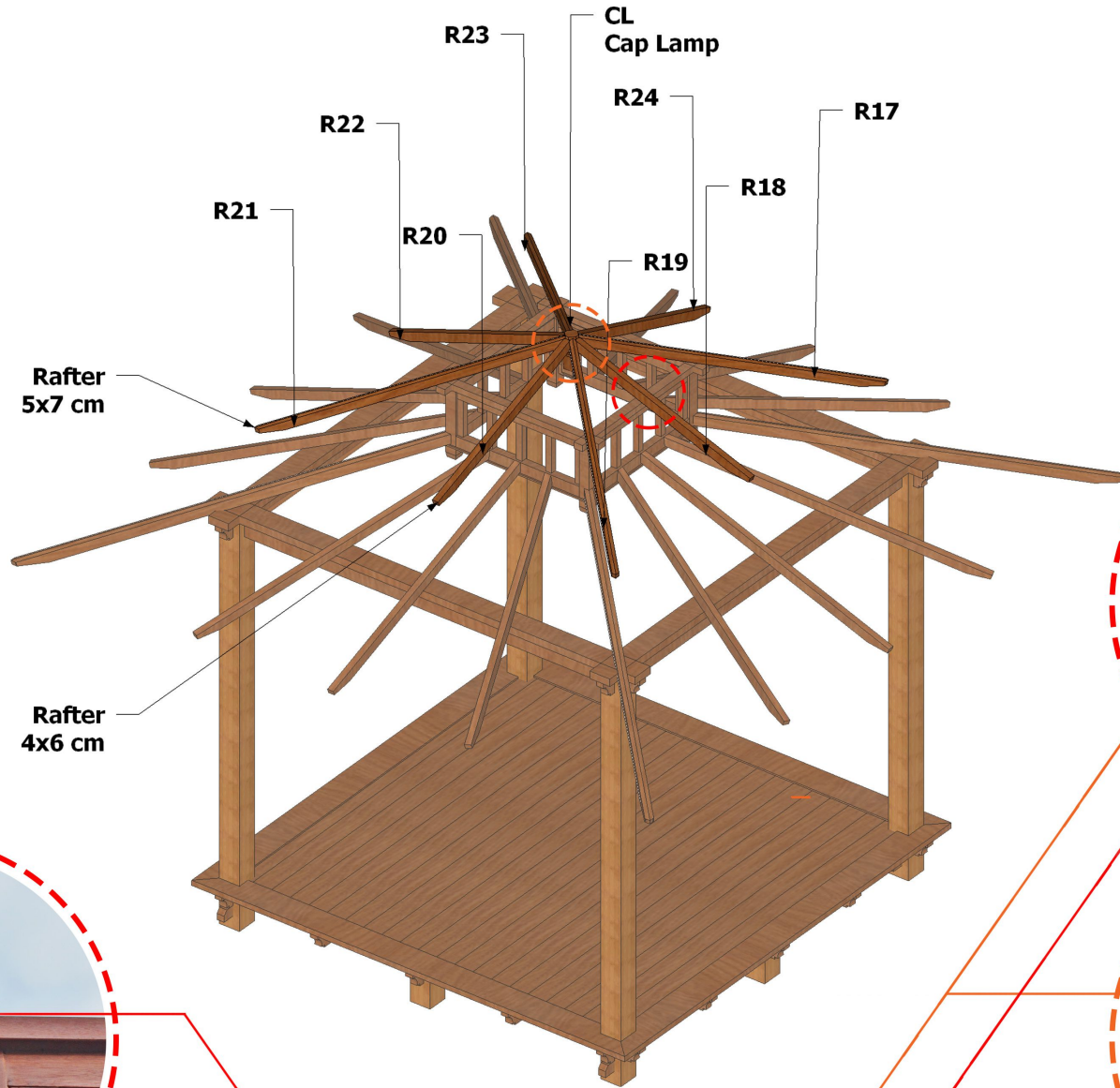

Rafter to Cap Lamp : DECK-SCREW 5 cm,8 pcs
 Rafter to Truss Support Frame : DECK-SCREW 7 cm,8 pcs

ASSEMBLY INSTRUCTIONS
 PROJECT : ANDREW
 LOCATION : USA

drawing title date 18/10/2018 scale NTS
STEP 7

 53x Jl.Uluwatu 2, Jimbaran-Bali-Indonesia
 Phone/fax: +62 361 8472 101
 info@pt-touchwood.com
 www.pt-touchwood.com

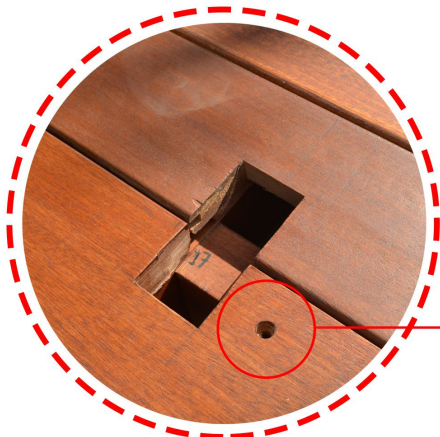
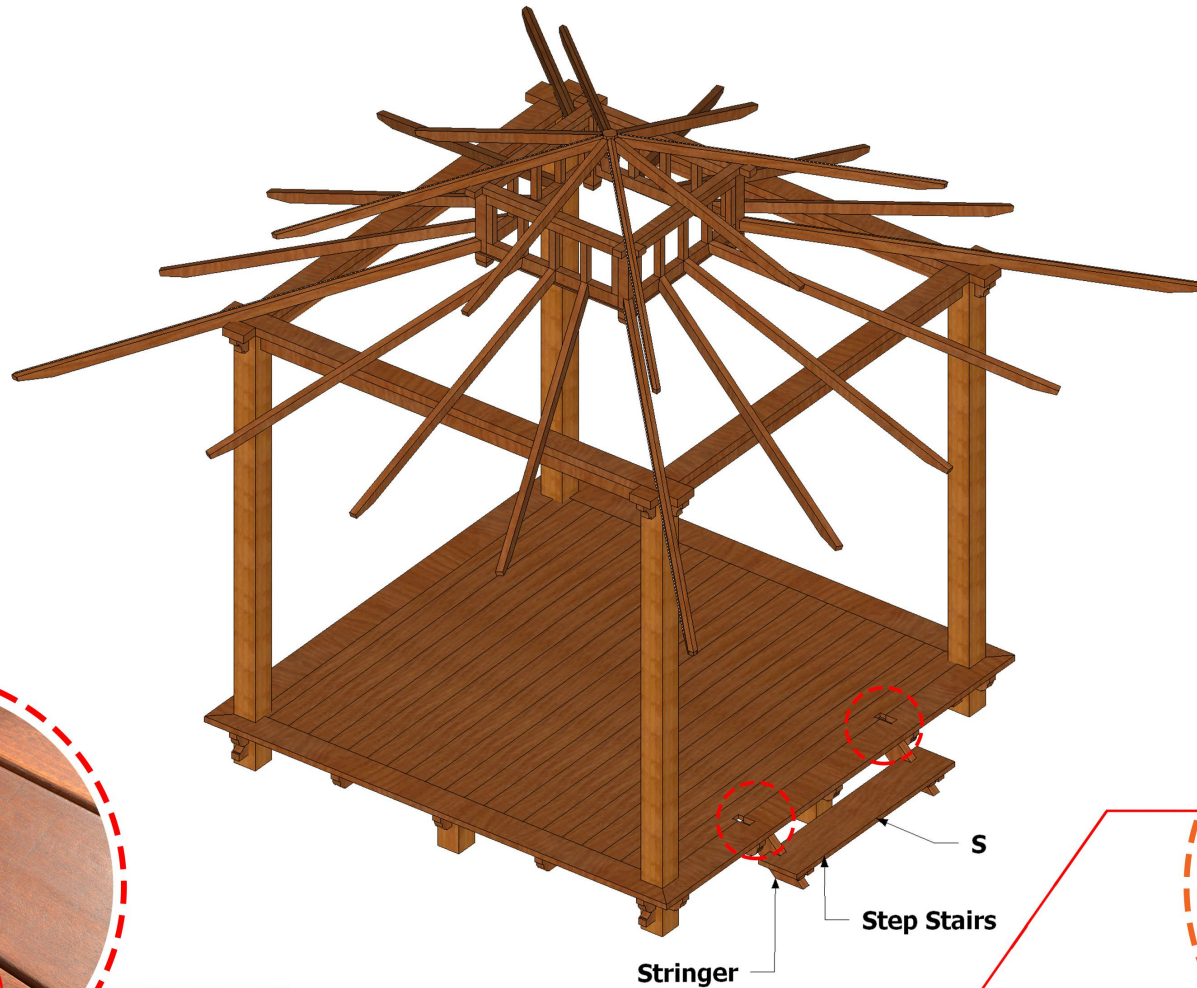

Cill Frame to Stringer Stairs : SCREW 7 cm,4 pcs

ASSEMBLY INSTRUCTIONS
 PROJECT : ANDREW
 LOCATION : USA

drawing title date 18/10/2018 scale NTS

STEP 8



53x Jl.Uluwatu 2, Jimbaran-Bali-Indonesia
 Phone/fax: +62 361 8472 101
 info@pt-touchwood.com
 www.pt-touchwood.com

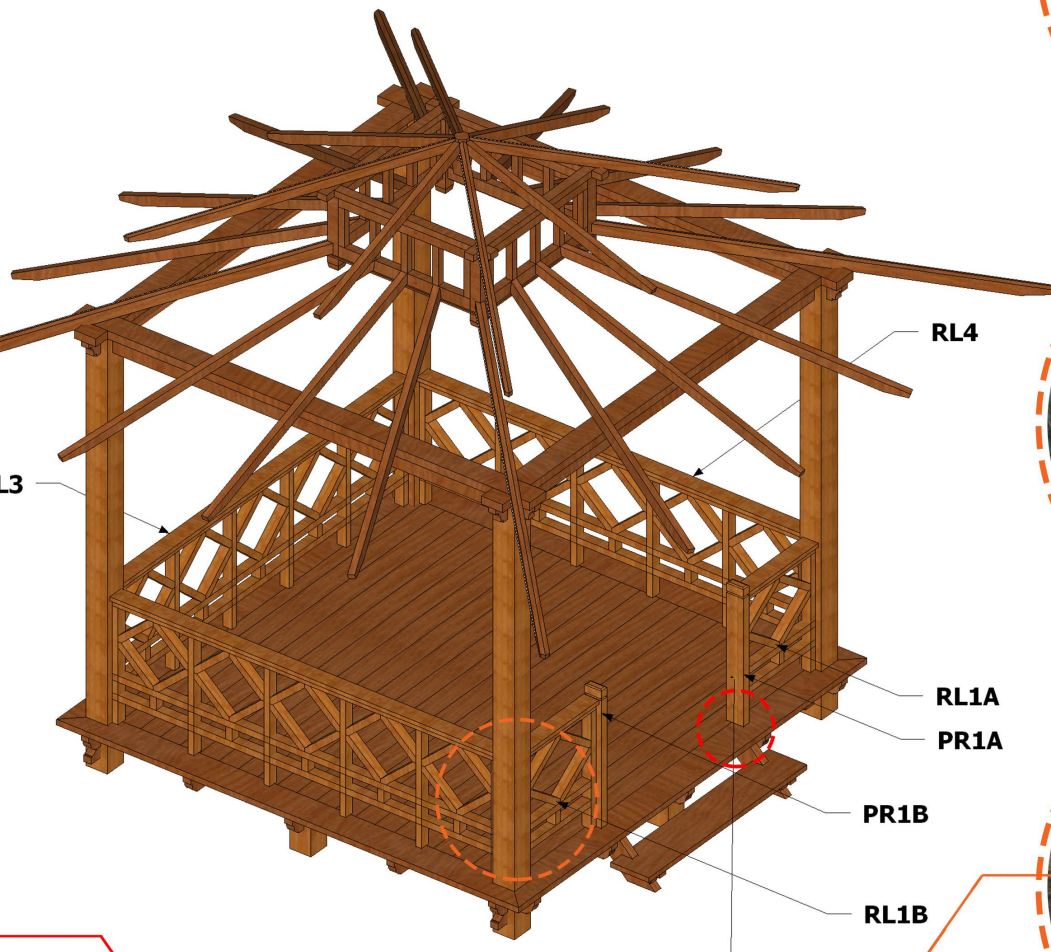

Post Railing 5 x 11 cm

- Railing to Post & Post Railing: DECK-SCREW 5 cm, 20 pcs
- Post Railing to Joist : Bolt 12 cm, 2 pcs

ASSEMBLY INSTRUCTIONS
 PROJECT : ANDREW
 LOCATION : USA

drawing title date 18/10/2018 scale NTS
STEP 9

53x Jl.Uluwatu 2, Jimbaran-Bali-Indonesia
 Phone/fax: +62 361 8472 101
 info@pt-touchwood.com
 www.pt-touchwood.com

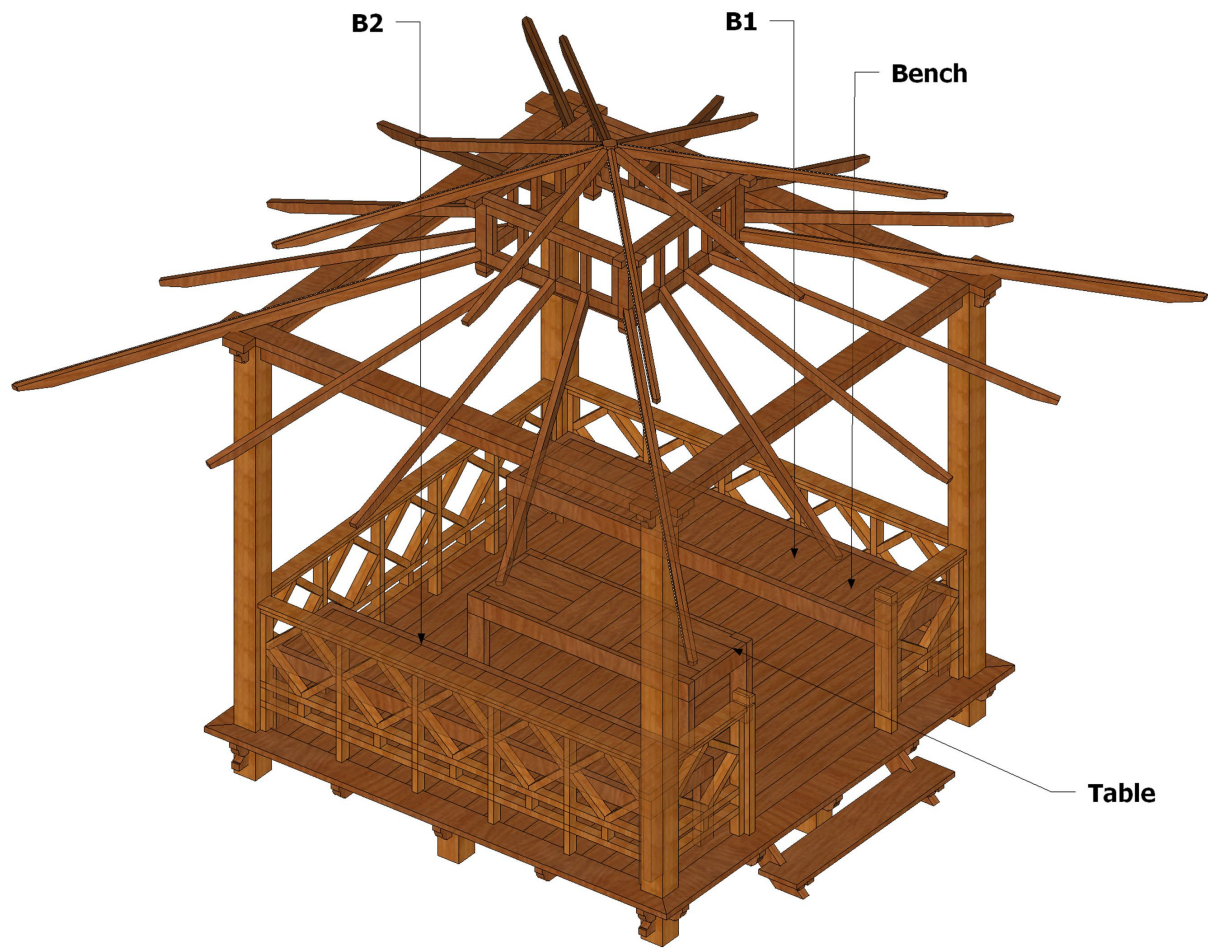

ASSEMBLY INSTRUCTIONS
PROJECT : ANDREW
LOCATION : USA

drawing title date 18/10/2018 scale NTS

STEP 10



53x Jl.Uluwatu 2, Jimbaran-Bali-Indonesia
Phone/fax: +62 361 8472 101
info@pt-touchwood.com
www.pt-touchwood.com

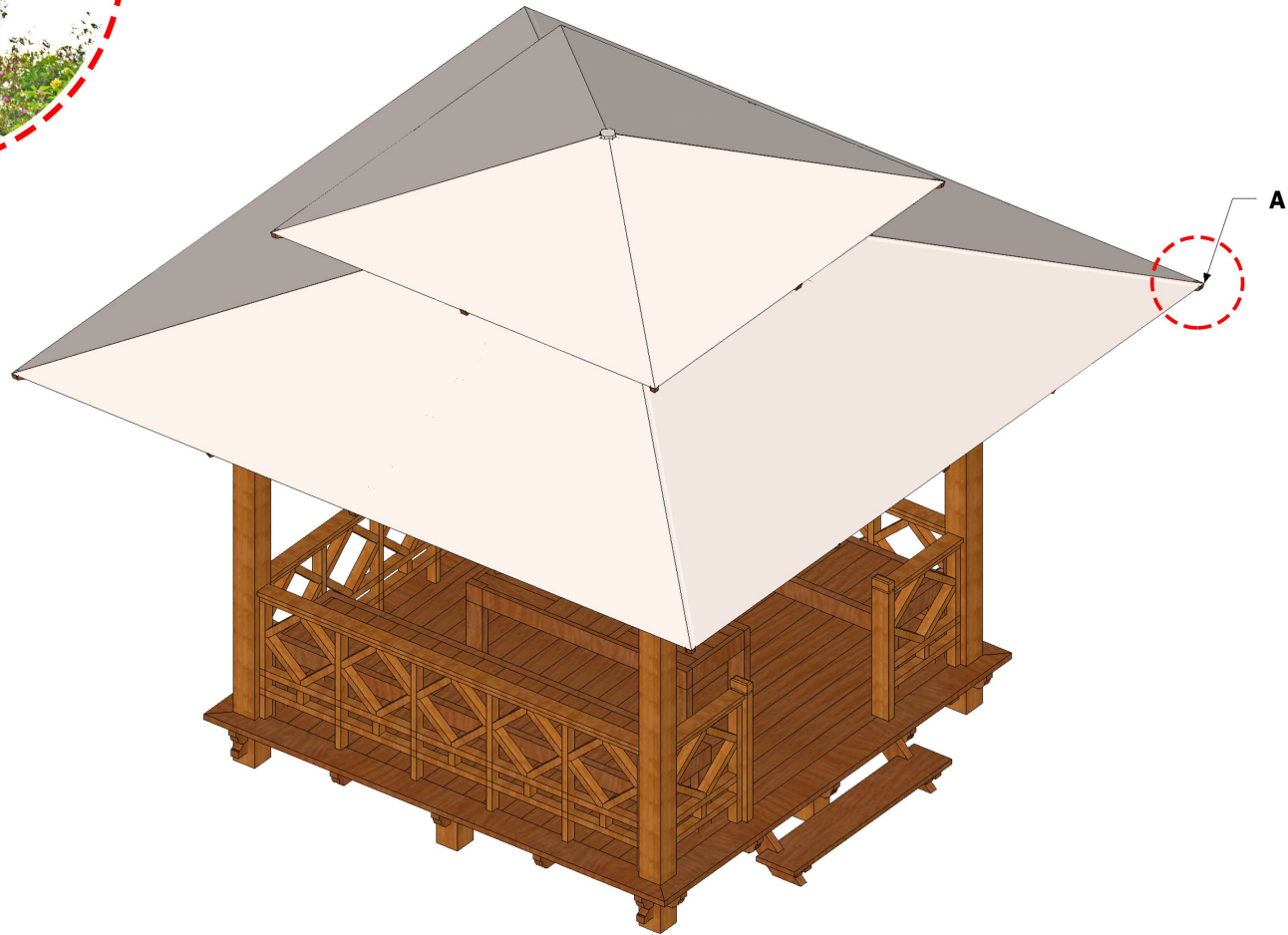

ASSEMBLY INSTRUCTIONS
PROJECT : ANDREW
LOCATION : USA

drawing title date 18/10/2018 scale NTS

STEP 11



53x Jl.Uluwatu 2, Jimbaran-Bali-Indonesia
Phone/fax: +62 361 8472 101
info@pt-touchwood.com
www.pt-touchwood.com