

Titan

Premium-Fleetwood II

INSTRUCTION MANUAL

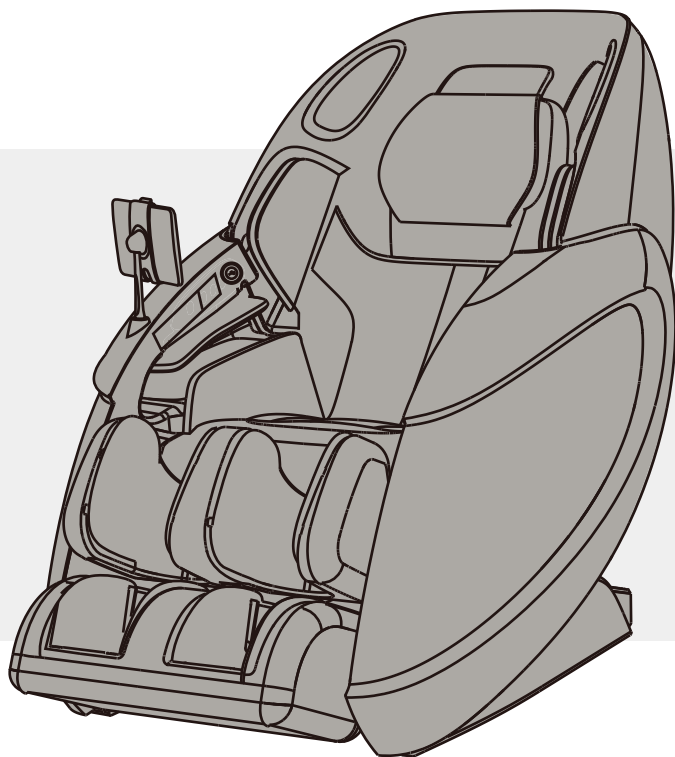

Please read all instructions carefully before using.

Thank you for purchasing this product. Please read this user manual carefully before using to ensure proper operation.

Please keep this USER MANUAL properly for future reference.





CONTENTS

SAFETY PRECAUTIONS	1
NAME AND FUNCTION OF EACH COMPONENT	3
External Structure	3
Internal Structure	3
Touchscreen Controller User Guide	4
Control Panel of the Armrest(see below figure)	12
Features	13
PRELIMINARY CHECKS	14
Clearance Space	14
Floor Protection	15
Best Circumstances	15
Grounding	15
Connect to Power	15
Installation Method	16
Move Method	21
Connect To Power	21
Commissioning	22
After Operation	22
Footrest Extends/Retracts	23
Instructions on Connecting audio to the massage chair speakers via Bluetooth(Android/Apple iOS)	23
CARE AND MAINTENANCE	24
TROUBLESHOOTING	25
PRODUCT SPECIFICATION	26

SAFETY PRECAUTIONS

Safety Precautions

- ▶ Before using, please read the SAFETY PRECAUTIONS carefully to ensure correct operation of this appliance.
- ▶ Precautions and warnings listed below will help to ensure proper operation of this appliance.
- ▶ The classes of accidents caused by incorrect use are classified into WARNING and CAUTION. Read all WARNINGS and CAUTIONS below and follow all instructions within this manual.

	WARNING	Improper operation may cause injury to users.
	CAUTION	Improper operation may cause injury to users or damage to product.
	Prohibited	
		NO Disassemble

Not suitable for below persons

We recommend that those with any of the following conditions should consult your physician before using.

 WARNING	<ul style="list-style-type: none"> ◆ Those with pacemaker or electronic devices implanted in the body. ◆ Those undergoing treatment, especially those who are not feeling well. ◆ Those with malignant tumors, acute disease, heart disease or severe hypertension. ◆ Need to be supervised. ◆ Women who are pregnant or menstruating. ◆ Those with osteoporosis, distorted joints, dysfunction or recent fracture. ◆ Those with serious or injured skin conditions. ◆ Those with high fever. ◆ The appliance has a heated surface. Persons insensitive to heat must be careful when using the appliance. (Need to be supervised) ◆ This appliance is not intended for use by persons (including children) with reduced physical, sensory or mental capabilities, or lack of experience and knowledge, unless they have been given supervision or instruction concerning use of the appliance by a person responsible for their safety. ◆ This appliance can be used by children aged from 8 years and above and persons with reduced physical, sensory or mental capabilities or lack of experience and knowledge if they have been given supervision or instruction concerning use of the appliance in a safe way and understand the hazards involved.
---	---

Controller Precautions

 CAUTION	<ul style="list-style-type: none"> ◆ Do not operate the controller with wet hands or pull the controller wire by force. ◆ Do not spill water or other liquid into the controller to avoid fault. ◆ Do not lay heavy items on the controller.
---	---

Cautions Regarding the Power Connectors and Power Cord





 CAUTION	<ul style="list-style-type: none"> ◆ The appliance is only to be used with the power supply unit provided with the appliance. ◆ It must only be supplied at safety extra low voltage corresponding to the marking on the appliance. ◆ Do not use a wet hand to unplug the AC cord to avoid electric shock. ◆ Do not pull on the power cord, reach to the front end to unplug it. ◆ Do not squeeze the power cord by heavy objects. ◆ Do not damage, over bend, pull hard or twist the power cord. ◆ If the supply cord is damaged, it must be replaced by the manufacturer or its service agent or a similarly qualified person in order to avoid a hazard.
---	--

SAFETY PRECAUTIONS

Best Circumstances

 CAUTION	<ul style="list-style-type: none"> ◆ Do not use this appliance where temperature is over 40°C. ◆ Do not use this appliance in moist or dusty environment. ◆ Unplug from outlet during thunder or lightening storms. ◆ Do not use outdoors. ◆ Please place the product on the flat level floor. ◆ Do not store near heat or open flame.
---	--

Best Practices for Safe Use

 CAUTION	<ul style="list-style-type: none"> ◆ Only for users weighs below 120kg. ◆ Do not use other therapeutic device together with this product. ◆ Use this product only for its intended use as described in this manual. ◆ Appliance should only be used by one person, do not use by two or more persons at the same time to avoid damage to the products. ◆ Do not use the product right after meal, it may cause discomfort. ◆ Remove the accessories from the arms and empty the pockets while use the massage services. ◆ Check the upholstery under the cushions and other spots, if any damages are present, do not use it and refer to a qualified service professional for servicing. ◆ If you feel any abnormal discomfort during the operation of this product, turn off the power immediately and do not use the product. ◆ Use the appliance for 20 minutes each time is highly recommended. ◆ Make sure there is no obstacles behind the chair and there is enough clearance before adjusting the backrest or footrest angle ◆ Make sure no other excessive load pressed on the backrest or footrest, keep children, pets or any other barrier away from the unit reclining backrest/extending footrest to prevent any accidental injury. ◆ Please be seated properly while using the appliance to avoid injury to the user or damage to the appliance. ◆ Do not drag or push the chair or roll on its casters on wood floor or carpet to avoid damage.
 PROHIBITED	<ul style="list-style-type: none"> ◆ Never operate this product if it has damaged /exposed parts or power leakage. ◆ Do not stand on or stack heavy objects on the footrest. ◆ Children should be supervised to ensure that they do not play with the massage chair. ◆ Do not fall into sleep while the product is operating. ◆ Avoid using the product under the influence of alcohol. ◆ Do not put hands or foreign objects in the openings of the appliance to avoid injury to the user or damage to the appliance. ◆ If there is any smoke or unusual smell during operation, stop using immediately.
 NO DISASSEMBLE	<ul style="list-style-type: none"> ◆ Do not disassemble this product to avoid failure. ◆ Do not attempt to repair or dismantle the appliance without permission. ◆ Please contact authorized dealer or service agent.
 UNPLUG POWER CORD	<ul style="list-style-type: none"> ◆ Pull out the power cord from the power strips before maintenance. ◆ Never plug in or pull out power cord with wet hand to avoid shock or injury. ◆ Pull out the power cord from the power strips after use. ◆ Unplug from outlet when the power supply is cut.

▶ NAME AND FUNCTION OF EACH COMPONENTS

External Structure

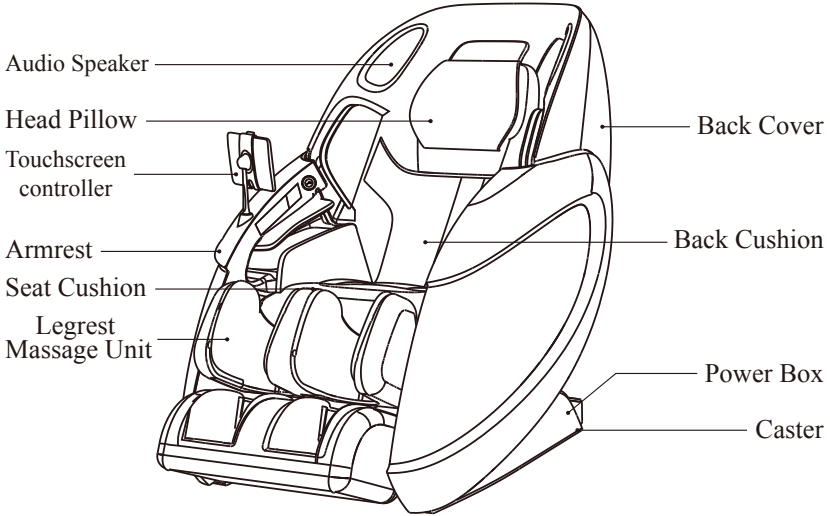

Internal Structure

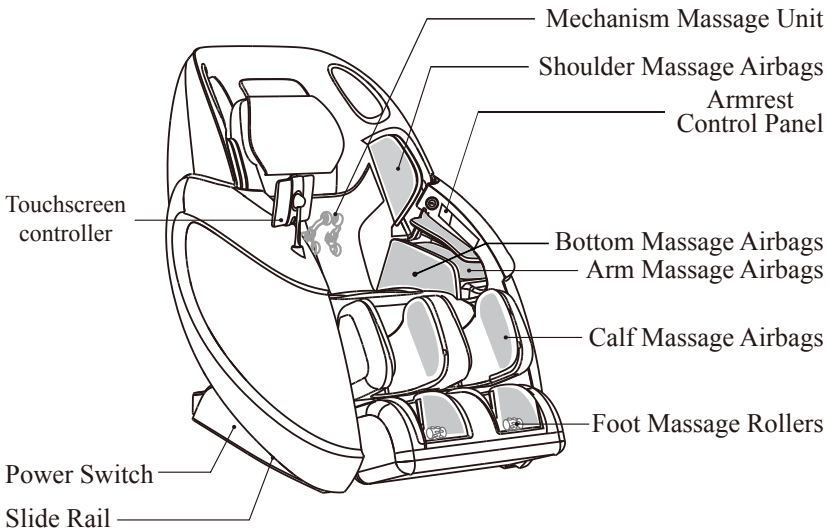

▶ NAME AND FUNCTION OF EACH COMPONENT

Touchscreen Controller User Guide

Home Screen | Home Screen may vary depending on the task you're performing.



Home Screen | Home Screen may vary depending on the task you're performing.

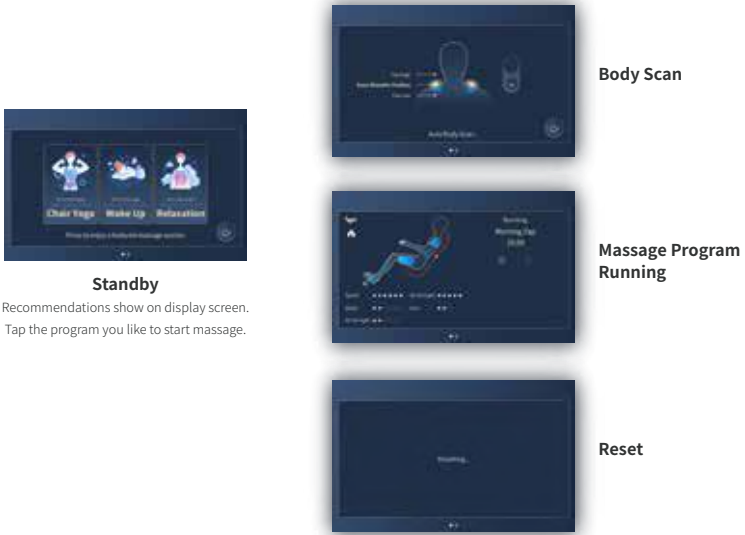

▶ NAME AND FUNCTION OF EACH COMPONENTS

M e n u | Function Menu
Message programs/Message chair adjustment/Settings

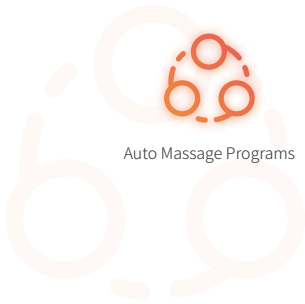

Tap the Auto icon to go to Auto screen, tap Feature/User/Focus/Classic to change category.

You may choose among 12 pre-set Auto wellness message programs. Tap the program you like to start.

About Auto Massage Programs



Chair Yoga

Uses moderate kneading and stretching techniques to relax tired muscles and keep them flexible.



Wake Up

Uses medium-high shoulder-pressing & invigorating wake up technique to stimulate and move the body's stressed muscles and set the tone for the entire day.



Relaxation

Uses medium-low full featured massage techniques to relax the lower body and revitalize tired and sore muscles.

▶ NAME AND FUNCTION OF EACH COMPONENTS

About Auto Massage Programs



Deep Tissue

Uses choreographed medium-high intensity massage techniques to bring utmost relief and comfort.



Gentle Treatment

Adopts mild shiatsu, kneading and pressing massage techniques to relieve body fatigue, boost viability of muscles and shape body figure.



Senior Priority

Soft massage session; relaxes muscles in the back, waist and hips; encourages flexibility and recovery.

About Auto Massage Programs



Neck & Shoulder

Uses unique kneading & pressing, lifting & pulling neck massage techniques to help to ease the pain and stiffness in neck and shoulders.



Back & Spine

Combination of deep tissue massage techniques; focuses on muscles along the spine, upper and lower back and lumbar.



Waist & Hip

Combination of deep tissue massage techniques; focuses on muscles on the lumbar, waist, thighs, and around the hip joints

▶ NAME AND FUNCTION OF EACH COMPONENTS

About Auto Massage Programs



Morning Zap

Stimulating all-over massage using various techniques; energizes and encourages a bright attitude.



Refreshing Nap

Soothing all-over massage using various techniques; soothes tension, improves digestion and refreshes the body.



Sweet Dreams

Gentle, calming all-over massage using various techniques; encourages relaxation in preparation for a restful sleep.

M e n u

Function Menu

Message programs/Message chair adjustment/Settings

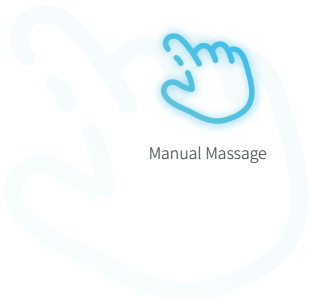

Manual Massage



Tap the massage technique and the way you like to start, you can adjust the manual massage settings during the massage session.

▶ NAME AND FUNCTION OF EACH COMPONENTS

About Manual Massage



Techniques Kneading, Sync, Knocking, Tapping, Shiatsu and 3D Shiatsu.

Tap the icon to start.

Part Whole, Partial and Point.

When Point massage is working, Point focus icon will show on the screen.



Tap and hold the icon to adjust the massage focus you desire.

Width Wide, Medium and Narrow.

Width is not adjustable if Kneading or Sync is selected. (☒)

3D Strength 5 levels and Off (turn off 3D Strength).

3D Strength is not adjustable if 3D Shiatsu is selected. (☒)

Speed 6 levels.

Speed is not adjustable if Shiatsu or 3D Shiatsu is selected. (☒)

M e n u

Function Menu

Message programs/Message chair adjustment/Settings

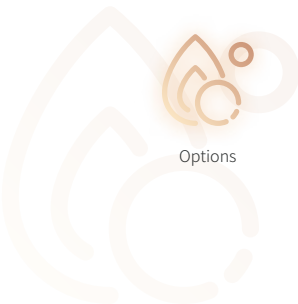

Options

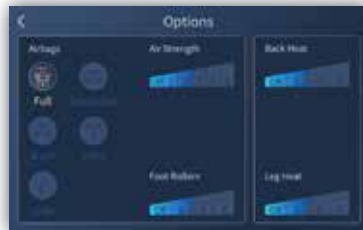

This page shows Airbags, Foot Rollers, Back Heat, Leg Heat options, you can adjust the Options settings during the massage session.

▶ NAME AND FUNCTION OF EACH COMPONENTS

About Options

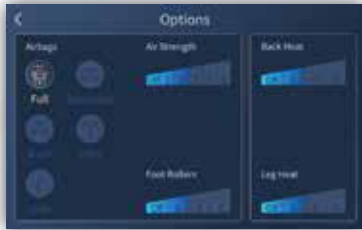

Airbags Full, Shoulders, Back, Hips and Legs.

Tap the icon to start.

Air Strength 5 levels and Off (turn off Air Strength).

Foot Rollers 3 levels and Off (turn off Foot Rollers).

This option is not adjustable if Full or Legs Airbags is selected.

Back Heat 3 levels and Off (turn off Back Heat).

Leg Heat 3 levels and Off (turn off Leg Heat).

M e n u

Function Menu

Message programs/Message chair adjustment/Settings

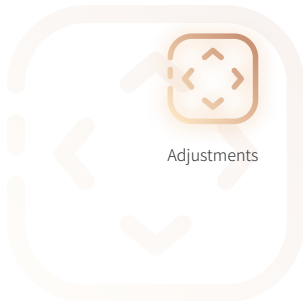

Adjustments



You can adjust Zero Gravity, Massage Time, Back Recline, Legs Up/Down/Extend/Retract in Adjustments.

▶ NAME AND FUNCTION OF EACH COMPONENTS

About Adjustments



- Zero Gravity** Zero 1, Zero 2, and Off (turn off Zero Gravity).
- Message Time** 10mins, 20mins and 30mins.
- Recline** Tap and hold the icon to recline/incline the massage chair back.
- Legs** Tap and hold the icon to lift/lower the massage chair footrest.
- Knees** Tap and hold the icon to move the upper part of legrest up/down.
- Feet** Tap and hold the icon to extend/retract the the footrest.

M e n u

Function Menu

Message programs/Massage chair adjustment/Settings

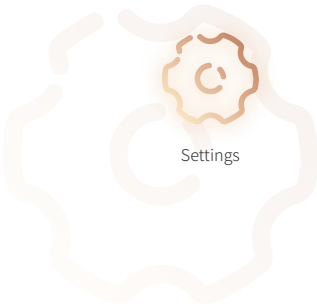

Settings

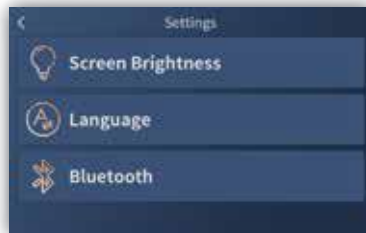

You can check all settings of the touch screen controller in Settings.
Tap the icon to see detailed information.

▶ NAME AND FUNCTION OF EACH COMPONENTS

About Settings



Screen Brightness

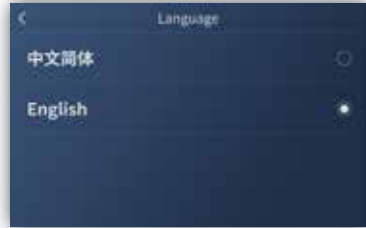

Language

About Settings



Bluetooth

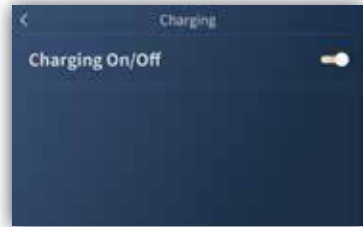

Charging

About Settings

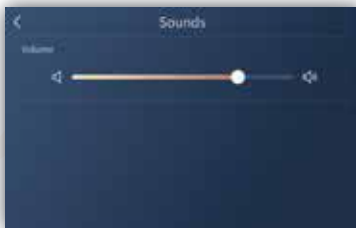

Sounds



About

▶ NAME AND FUNCTION OF EACH COMPONENTS

Control Panel of the Armrest(see below figure)

- ▶ **Power/Auto Program button:** Press this button to start the chair when connected with power, press this button again to start the auto program; press and hold this button for 2+ seconds to power off the massage chair.
- ▶ **Back Inclines:** Press and hold to incline the backrest to upright position; Release the button to stop.
- ▶ **Back Reclines:** Press and hold to recline the backrest; Release the button to stop.
- ▶ **Time:** Set the working time for the appliance, may choose 10min, 20min or 30min.
- ▶ **Pause:** Press the Pause button to temporarily stop running the massage program, press this button again to continue. When the massage chair is paused, the Pause button and the Power/Auto Program button on the Control Panel of the Armrest are enabled, the Power button on the remote controller is enabled. All other buttons are disabled.
- ▶ **Pause:** Press the Pause button to temporarily stop running the massage program, press this button again to continue. When the massage chair is paused, the Pause button and the Power/Auto Program button on the Control Panel of the Armrest are enabled, the Power button on the remote controller is enabled. All other buttons are disabled.
- ▶ **Back Heat:** Press to activate level-2 back heat or turn off heat function.
- ▶ **Air Pressure:** Press to adjust the air pressure intensity from level-1 to level-5.

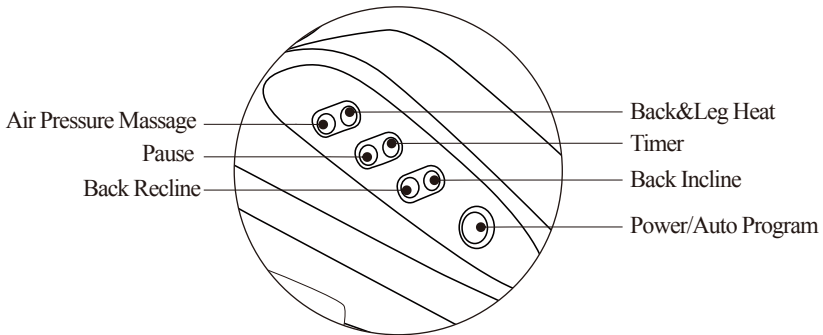

▶ NAME AND FUNCTION OF EACH COMPONENTS

Features

1. One Press Control Sliding

It will slide forward by 16cm and recline afterwards, glider recliner linkage mechanism to save space and provide utmost relaxing position.

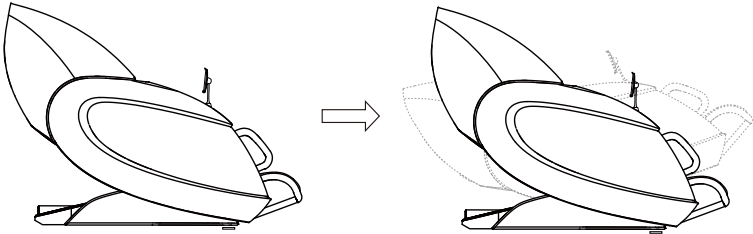

2. Zero Gravity Position

Developed by NASA scientists, the Zero Gravity technology has incorporated into our massage chair design, at such a weightless position that the height of the legs slightly higher than the upper body, the weight of body can evenly distributed throughout, reducing the pressure of the spine and joints both physically and mentally.

3. Human Hand Quad Style Massage Mechanism

Innovative human hand quad style massage mechanism and L-shaped guiding track conform to ergonomic principle.

4. Auto/Manual Footrest Extension

The footrest can extend by 16cm automatically for various users of different height ranges.

5. Whole Body Air Pressure Massage

Whole body air pressure massage for arms, back, waist, legs and feet.

6. Roller Massage

3 underfoot rollers provide hand simulation rolling and shiatsu massage underfoot for the reflex zone.

7. Versatile Massage Techniques

Mimic human hand kneading, knocking, sync, tapping, shiatsu and 3D shiatsu massage techniques for custom-tailored relaxation.

8. Pressure Sensitive Mechanism

Pressure sensing system is built in the mechanism of this massage chair, when the Auto massage program is running, the massage techniques will adjust the mechanism 3D protruding intensity to suit the users' personal preferences.

PRELIMINARY CHECKS

Clearance Space

Clearance space for the massage chair:

- ▶ Ensure there is an adequate clearance for the installation:
 - It needs 10cm clearance for the recline of the backrest;
 - It needs 60cm clearance for the raise and extension of the footrest;
 - Make sure there is 10cm clearance behind the backrest and 60cm clearance in front of the footrest.
- ▶ Keep it 1 meter away from the TV, radio or other audio&video appliance to avoid signal interference.

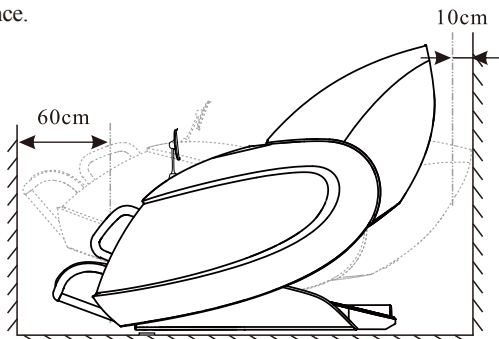

- ▶ Keep the distance between the power socket and power switch within 1.5 meter.

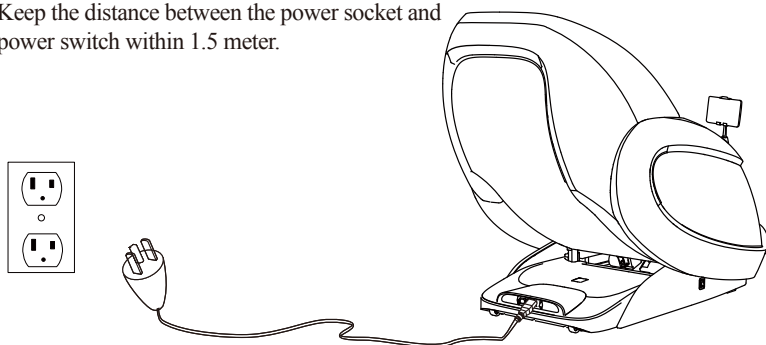

CAUTION

- ▶ Keep the distance between the power socket and power switch within 1.5 meter to avoid damage of power cord while massage chair sliding forward.
- ▶ Straighten the power cord while in use to avoid tangle or damage.
- ▶ When the massage chair sliding forwards or back, please check to make sure there is no children, pets or other obstacles around to avoid accident. Straighten the power cord while in use to avoid tangle or damage.

PRELIMINARY CHECKS

Floor Protection

- ▶ We recommend to place a piece of carpet or soft mat underneath it to avoid damaging the floor.

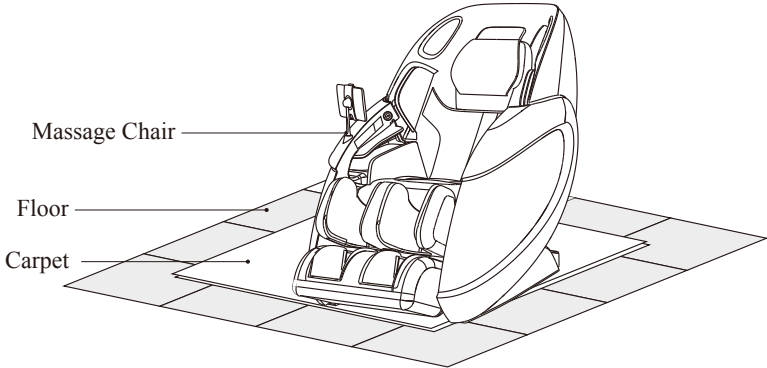

Best Circumstances



Do not use the massage chair in high moisture environment such as near swimming pool or bathroom to prevent electric shock accident.



Please keep the massage chair away from heated surfaces to prevent fire hazard or damage to the product.

Grounding



This product must be grounded, the plug must be plugged into an appropriate 3-wire grounded outlet that is properly installed and grounded in accordance with all local codes and ordinances to reduce risk of electrical shock.

Connect to Power

- ▶ Connect this appliance to a 3-wire properly grounded outlet.
- ▶ Turn on the main power switch by the right hand side of the massage chair.

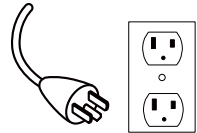

CAUTION

- ▶ Please verify that there is no damage to the supply cord before switching on the massage chair.
- ▶ Please verify that the main power switch is turned off before connecting to power.

PRELIMINARY CHECKS

Installation Method

Step 1: Take all massage chair units out of the cartons

- ▶ Unpack the cartons:take out all upholstery unit,accessories out of the cartons.
- ▶ Before beginning installation,please verify that all components are included (check with the packing list carefully)

Step 2: Install Armrest Unit

- ▶ Connect the Air Hose of the Seat Base unit with the Air Nozzle of the Armrest Unit;(Illustration 1)

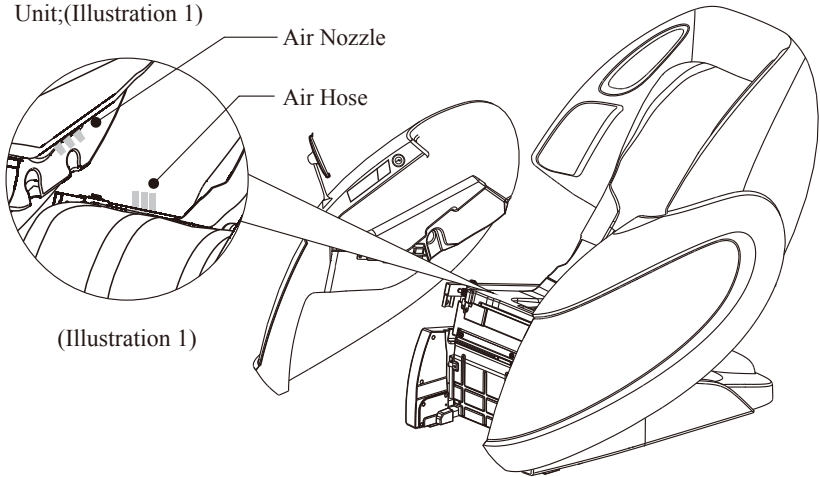

(Illustration 1)

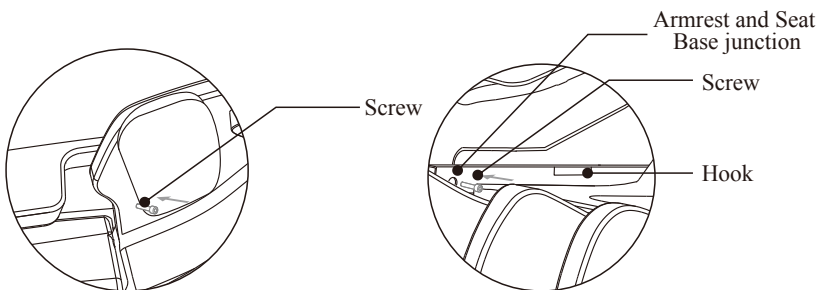

(Illustration 2)

(Illustration 3)

- ▶ Firstly hook the armrest onto the Chair Base,secondly fix the screw into the screw hole at the rear end of the armrest(Illustration 2),then fix the screw at the front part of the armrest (Illustration 3).(Same installation method with the other side)

▶ PRELIMINARY CHECKS

Step 3: Install The Legrest Unit

- ▶ Lift the Legrest Massage Unit, fit the Hook of the Legrest unit into the Coupling Shaft located at the Seat base (Keep the hook leveled with the coupling shaft), connect one side first then the other.

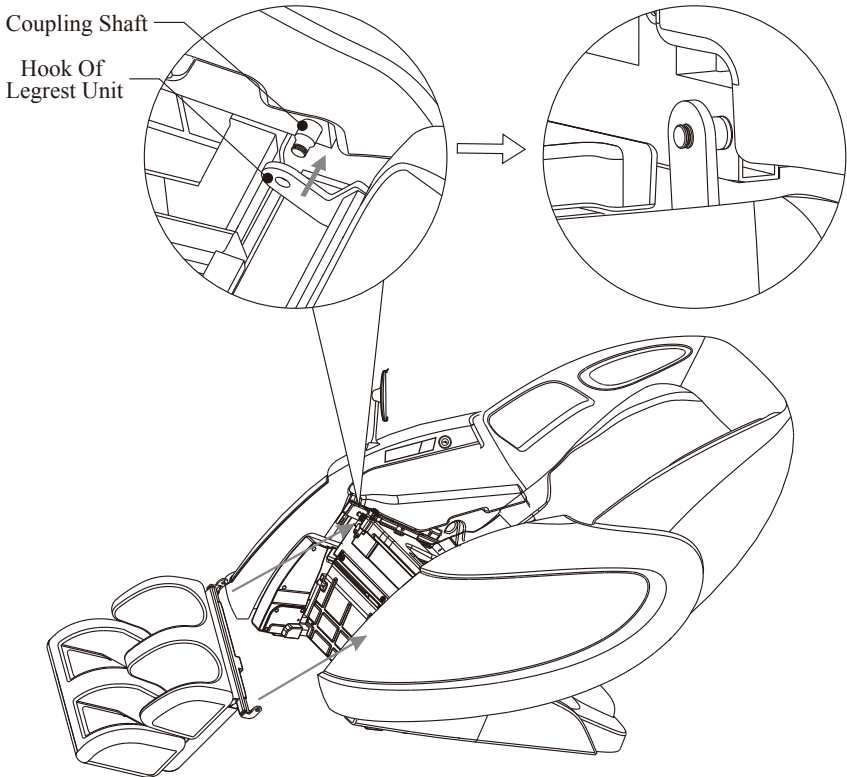

PRELIMINARY CHECKS

- ▶ Connect the legrest unit with the Coupling Shaft, fit the DK Circlip to the end of the shaft and lock it (check the illustration below)

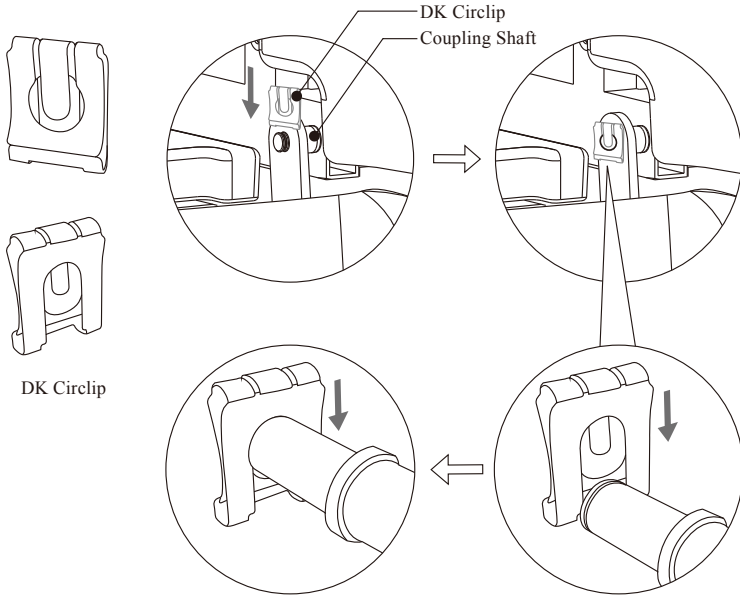

- ▶ Raise the Legrest unit, thread the Air Hoses into the Air Nozzle, and fit the Air Valve plug into the Air Valve Port which located at the face side of seat base, make sure they are well secured. (check the illustration below)

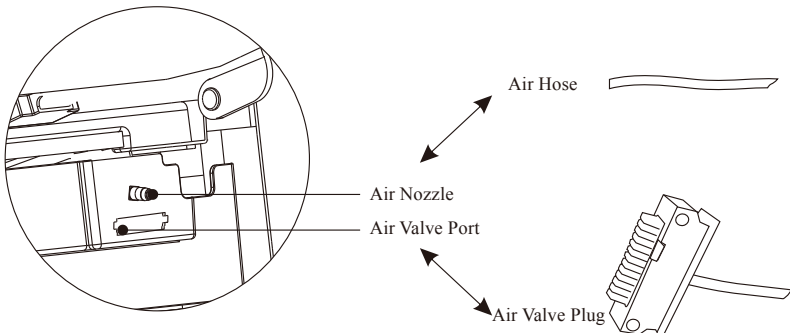

▶ PRELIMINARY CHECKS

Step 4: Install the controller unit

- ▶ Take the controller unit out of the accessories box;
Connect the data line of the controller to the port to the lower inner side of the right armrest (pay attention to the convex and concave of the connector and port), then tighten the screw cap clockwise. (Check the illustration below for reference)

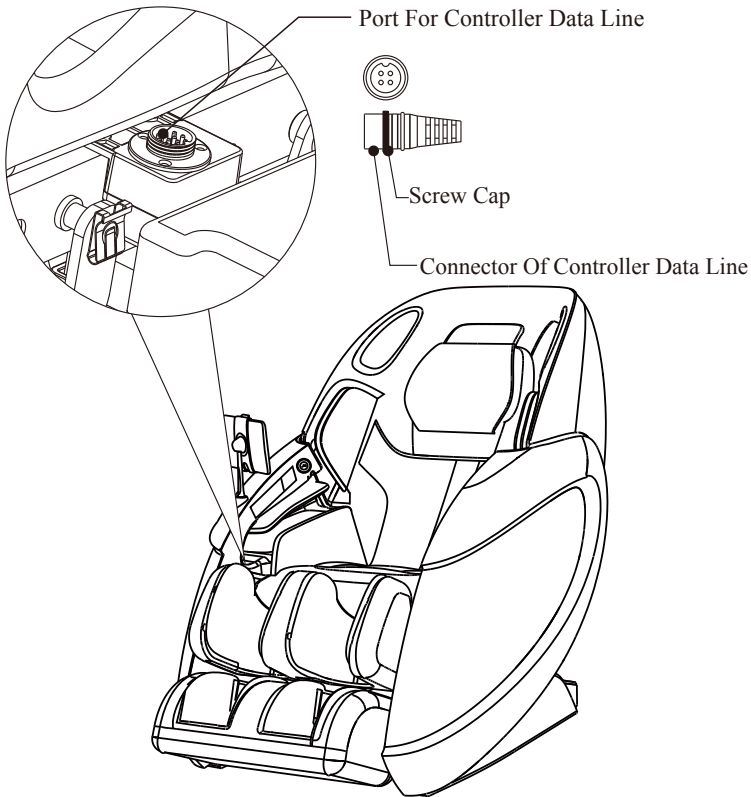

▶ PRELIMINARY CHECKS

Step 5: Other Accessories

- ▶ Connect the power cable to the product power socket located at the power box of the product. (Check below illustration for reference)
- ▶ Switch ON the power by the lower outer side of the right armrest, raise the backrest of the product to fully upright position.

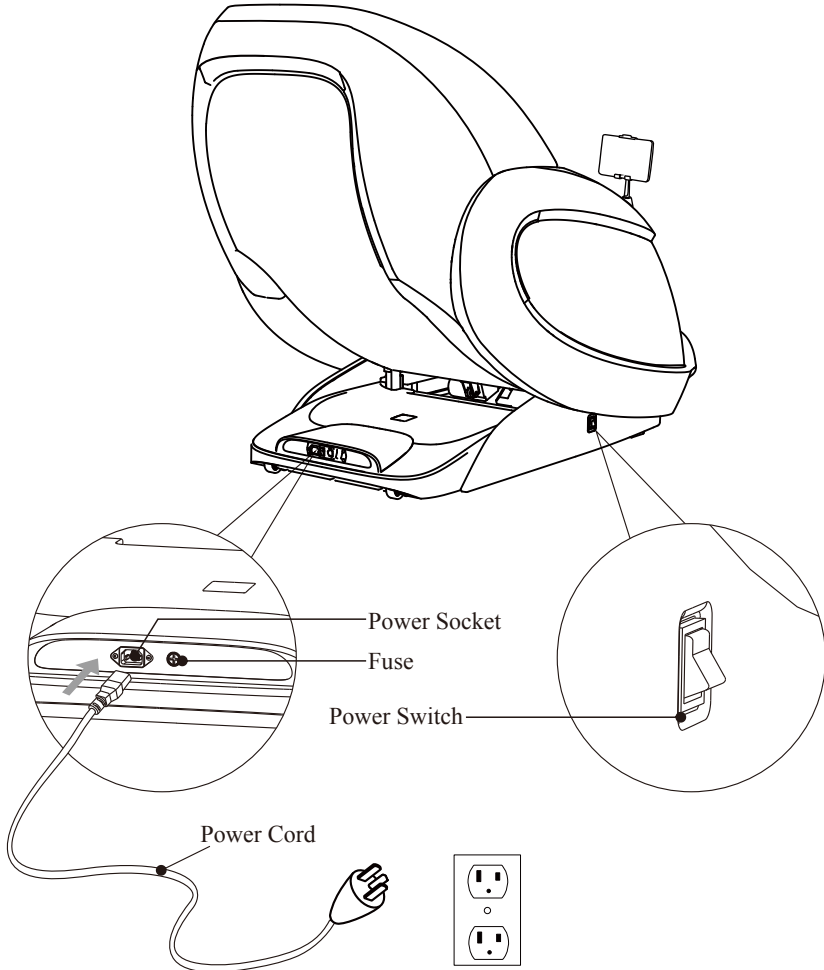

- ▶ After the installation of all accessories, plug the power cord into a well grounded three cord socket, switch on the power, use the controller to start the operation (check above illustration) .

▶ PRELIMINARY CHECKS

Move Method

- ▶ Roll the chair on its casters to the desired location.
- ▶ Incline the backrest to upright position.
- ▶ Turn off the power switch and unplug the appliance from the electrical outlet.
- ▶ Using two people, push down on the backrest and lift up on the front side by grabbing the moving holder located to the front bottom of the armrest, roll the chair on its casters to the desired location (check the sketch for reference)

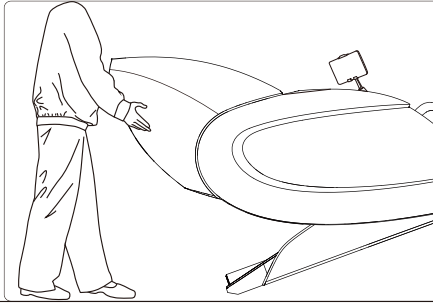

CAUTION

- ▶ Do not move the chair when there is user inside.
- ▶ To carry this product, do not lift by the footrest or armrest, hold the chassis and steady the backrest (have 4 or more people to carry the product).

Connect To Power

- ▶ Connect this appliance to a 3-wire properly grounded outlet.
- ▶ Turn on the main power switch located to the lower back of the right armrest.

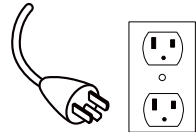

CAUTION

- ▶ Please verify that there is no damage to the supply cord before plug in.
- ▶ Please verify that the main power switch is turned off before connecting to power.

▶ PRELIMINARY CHECKS

Commissioning

- ▶ Use the controller to recline the backrest to the ultimate angle, lift and extend the footrest to the maximum, make sure there is enough clearance before commissioning.
- ▶ Reset the chair after commissioning and turn off the power switch.
(To choose the massage program, please check the Instruction of Controller and Instruction of Display Screen for reference)

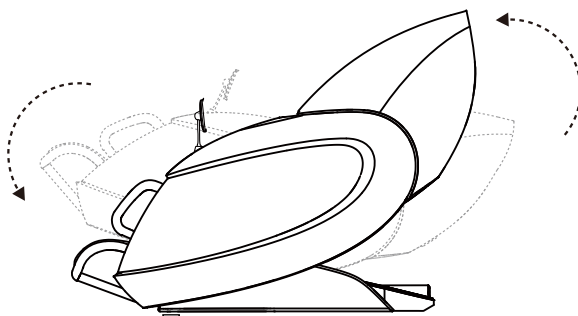

CAUTION

- ▶ Do not take seat while the legrest is lifted.
- ▶ Do not put excessive load on the legrest to avoid damage.

After Operation

- ▶ Always unplug the massage chair from the electrical outlet immediately after using.
- ▶ Put the controller into the controller pocket.
- ▶ Turn off the power switch and unplug the massage chair from the electrical outlet while not in use to avoid children start the massage chair accidentally.
- ▶ When not in use for a long period of time, we recommend that the chair be covered, the power cord be coiled and that the unit be placed in an environment free of dust and moisture.

▶ PRELIMINARY CHECKS

Footrest Extends/Retracts

- ▶ Press and hold “◀▶” or “▶▶” button on the controller to extend or retract the footrest to the length you desire for better massage experience, release the button to fix the position.

Footrest Extended → ◀▶

Footrest Retracted → ▶▶

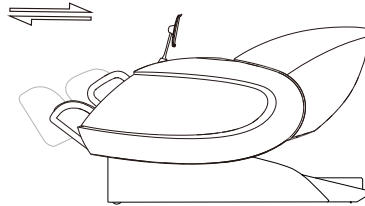

- ▶ A footrest sensor is set at the bottom of footrest, the footrest will adjust the length automatically once the chair started.



WARNING

- ▶ Do not play on the massage chair or operate it improperly.
- ▶ Ensure there is no obstruction when raising or reclining the backrest and footrest.
- ▶ Do not place foot, fingers or any other objects in the space between the seat and the backrest/footrest when it is in the reclining or raising motion.
- ▶ Ensure massage chair is restored back to its original position before getting off the massage chair.

Instructions on Connecting audio to the massage chair speakers via Bluetooth(Android/Apple iOS)

- ▶ On your Android/Apple iOS device, go to Settings > Bluetooth and turn on Bluetooth. Place your massage chair in discovery mode and wait for it to appear on your Android/Apple iOS device. Choose RT7709S to pair, when it displays Bluetooth connected, it's set to go.



CAUTION

- ▶ The massage chair power and the Bluetooth need to set to On while pairing.
 - ▶ If the pairing failed, try to connect again.
-
- ▶ Always unplug the massage chair from the electrical outlet immediately after using.
 - ▶ Put the Controller into the Controller Pocket.
 - ▶ Turn off the power switch and unplug the massage chair from the electrical outlet while not in use to avoid children power on the massage chair accidentally.
 - ▶ When not in use of a long period of time, we recommend that the chair be covered, the power cord be coiled and that the unit be placed in an environment free of dust and moisture.

CARE AND MAINTENANCE

Care Instructions

- ▶ To treat stains on back panel, armrest, footrest, plastic parts or air hose, spot clean with mild detergent foam, then wipe it with a dry cleaning cloth.
- ▶ To treat stains on controller, power box, spot clean with a dry cleaning cloth.
- ▶ To treat stains on back cushion or pillows, use a water-based upholstery cleaner only, wipe it with moist cloth, then air dry.
- ▶ To clean the foot/calf unit covers, remove it from the chair, hand wash with a mild detergent, then line dry.

WARNING

- ▶ Children shall not play with the appliance. Cleaning and user maintenance shall not be made by children without supervision.
- ▶ Pull out the power cord from the power strips before care and maintenance.
- ▶ To avoid electrical shock or injury, do not touch the power cord with wet hands.
- ▶ Make sure no detergent enter into the power box while cleaning.
- ▶ Do not use benzene, thinner or other solvents on your product, it may cause fading or damage to the product.
- ▶ Do not iron the upholstery.

Storage Methods

- ▶ Cover the product with a dust-free cloth to prevent collection of dust if not in use of a long period of time.

CAUTION

- ▶ Do not leave this product exposed to direct sunlight for long periods of time. This may cause fading or damage.

Warm Tips

- During daily use, please check for the following symptoms:
- ▶ Burnt smell.
 - ▶ Power flickers on and off when touching the charging cable.
 - ▶ The power cord is hot.
 - ▶ Other abnormal symptoms.

CAUTION

- ▶ Please stop using the product to avoid breakdowns or accidents if any above symptom exists.
- ▶ Switch off the power button and disconnect the plug, contact the local distributors or supplier for repair.
- ▶ All other servicing except above care and maintenance should be serviced by an authorized dealer or service center.



WARNING Pull out the power cord from the power strips before care and maintenance. To avoid electrical shock or injury, do not touch the power cord with wet hands. Do not try to dismantle or repair the product yourself, please send your massage chair to the authorized service center.

▶ TROUBLESHOOTING

No.	Symptoms	Possible Causes	Possible Solutions
1	Noise is heard while in use	This sound is normal and comes from the air pump motor or other mechanical parts rubbing against the cloth cover	No need to take any measures
2	Appliance does not start	The power cord is not secured into the socket	Insert the power plug properly into the power socket
		Power switch is off	Turn on the switch
		The fuse is blown	Replace only with a fuse of same type and rating
3	No music comes from the speaker	The volume is turned to the lowest	Adjust the speaker volume from the mobile devices
		Bluetooth is off	Switch on Bluetooth
		Bluetooth connected with other device	Reconnect Bluetooth
4	Backrest or footrest can not raise or recline	Excessive load has been pressed on the backrest or legrest	Reduce the load and try again
5	Airbag malfunction	The air hose may be blocked	Straighten the air hose and clear out the blockage

If problem remains, please contact the dealer for maintenance.

Important: Do not attempt to repair this product yourself, our company shall not be liable for the injury or damage caused by any servicing without authorization.

PRODUCT SPECIFICATIONS

Product name: Titan Massage Chair
Model number: Premium-Fleetwood II
Rated voltage: 110-120V~
Rated frequency: 60Hz
Rated current: 1.6A

▶ GROUNDING INSTRUCTIONS

This product must be grounded. If it should malfunction or breakdown, grounding provides a path of least resistance for electric current to reduce the risk of electric shock. This product is equipped with a cord having an equipment-grounding conductor and a grounding plug. The plug must be plugged into an appropriate outlet that is properly installed and grounded in accordance with all local codes and ordinances.

DANGER – Improper connection of the equipment-grounding conductor can result in a risk of electric shock. Check with a qualified electrician or serviceman if you are in doubt as to whether the product is properly grounded. Do not modify the plug provided with the product – if it will not fit the outlet, have a proper outlet installed by a qualified electrician.

This product is for use on a nominal 120 V circuit and has a grounding plug that looks like the plug illustrated in sketch A in following figure. Make sure that the product is connected to an outlet having the same configuration as the plug. No adapter should be used with this product.

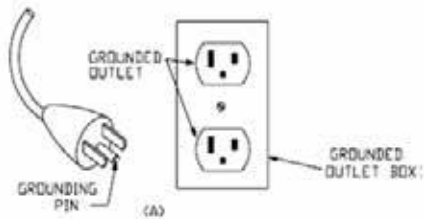

Earthing

This massage chair belongs to Level One electrical appliance, make sure to use three-core power supply socket and to guarantee the ground wire connected to the power supply socket has obtained good ground connection to avoid electric leakage, electric shock and some other negative effect during use

IMPORTANT SAFETY INSTRUCTIONS

Read all instructions before using (this appliance).

DANGER – To reduce the risk of electric shock:

1) Always unplug this appliance from the electrical outlet immediately after using and before cleaning.

WARNING – To reduce the risk of burns, fire, electric shock, or injury to persons:

1) An appliance should never be left unattended when plugged in. Unplug from outlet when not in use, and before putting on or taking off parts.

2) Do not operate under blanket or pillow. Excessive heating can occur and cause fire, electric shock, or injury to persons.

3) Close supervision is necessary when this appliance is used by, on, or near children, invalids, or disabled persons.

4) Use this appliance only for its intended use as described in this manual. Do not use attachments not recommended by the manufacturer.

5) Never operate this appliance if it has a damaged cord or plug, if it is not working properly, if it has been dropped or damaged, or dropped into water. Return the appliance to a service center for examination and repair.

6) Do not carry this appliance by supply cord or use cord as a handle.

7) Keep the cord away from heated surfaces.

8) Never operate the appliance with the air openings blocked. Keep the air openings free of lint, hair, and the like.

9) Never drop or insert any object into any opening.

10) Do not use outdoors.

11) Do not operate where aerosol (spray) products are being used or where oxygen is being administered.

12) To disconnect, turn all controls to the off position, then remove plug from outlet.

13) Do not use massager in close proximity to loose clothing or jewelry.

14) Keep long hair away from massager while in use.

15) Use heated surfaces carefully. May cause serious burns. Do not use over insensitive skin areas or in the presence of poor circulation. The unattended use of heat by children or incapacitated persons may be dangerous.

SAVE THESE INSTRUCTIONS

For use household only

RT7900S.22.6.1.5-1000336-A2

此画板不做印刷

210mm

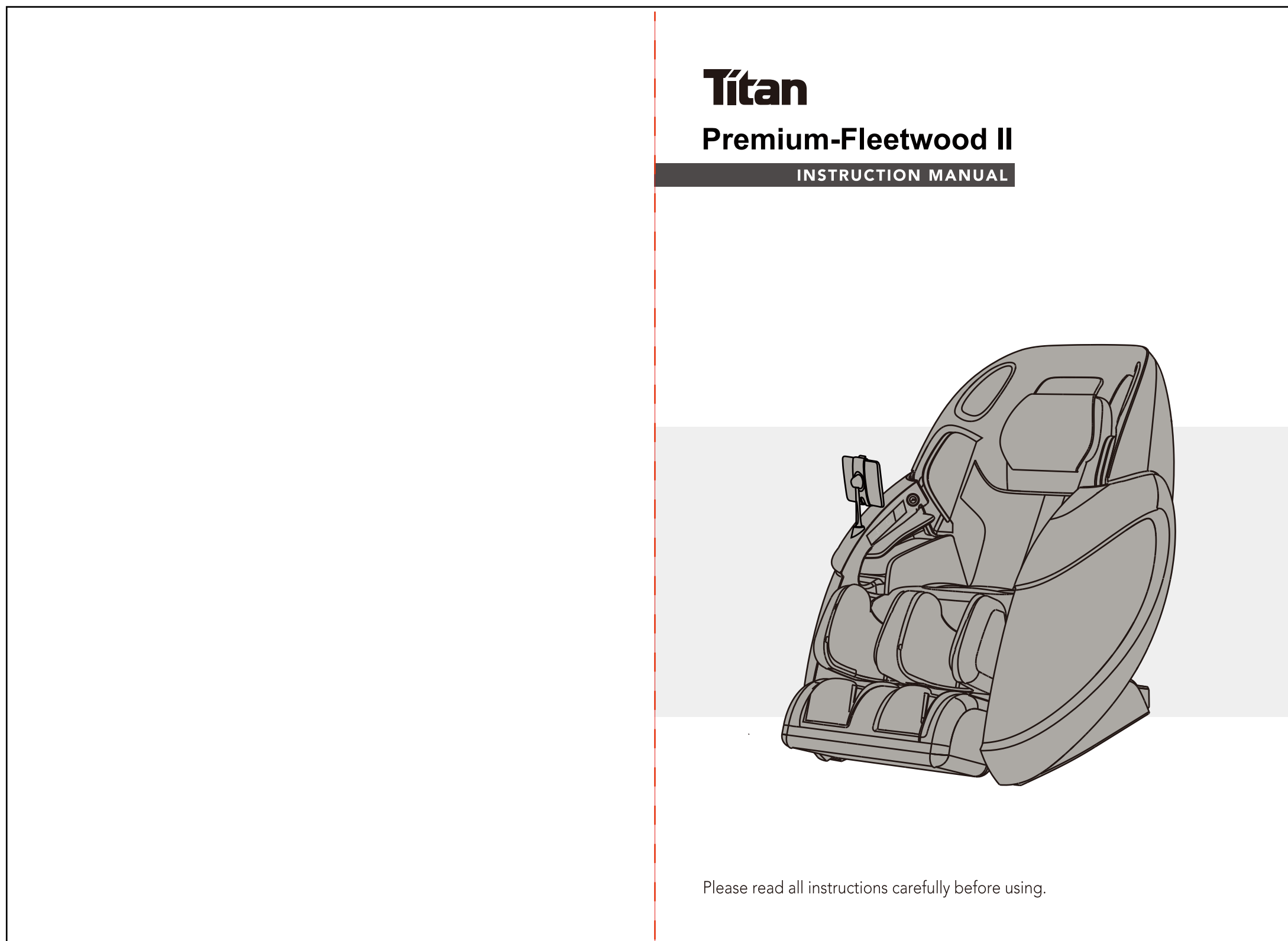

145mm

对折线

技术要求：

- 1.材质：157g铜版纸；
- 2.尺寸：145*210mm，32K32P；
- 3.色号：彩色；
- 4.工艺：双面印刷；
- 5.公差：±1mm；
- 6.外观要求：套印准确、清晰；冲裁居中、无毛边；
- 7.成品尺寸、模切尺寸符合要求，偏差在允许范围内，标贴尺寸的未注公差按GB/T1804-2000中等级别c执行；

借通用登记表

描图

校描

旧底图总号

签字

日期

					上海荣泰健康科技股份有限公司		
					英文说明书110V		
					RT7900S.22.6.1.5-1000336-A2		
标记	处数	更改文件号	签字	日期	图样标记	数量	文件：实物
设计			标准化				
校对			审定				
工艺			批准				
审核			日期		共 1 页	第 1 页	