

*Osaki*

**OS-Pro 4D DuoMax  
MASSAGE CHAIR**

Operation Instructions

**SAVE THESE INSTRUCTIONS**

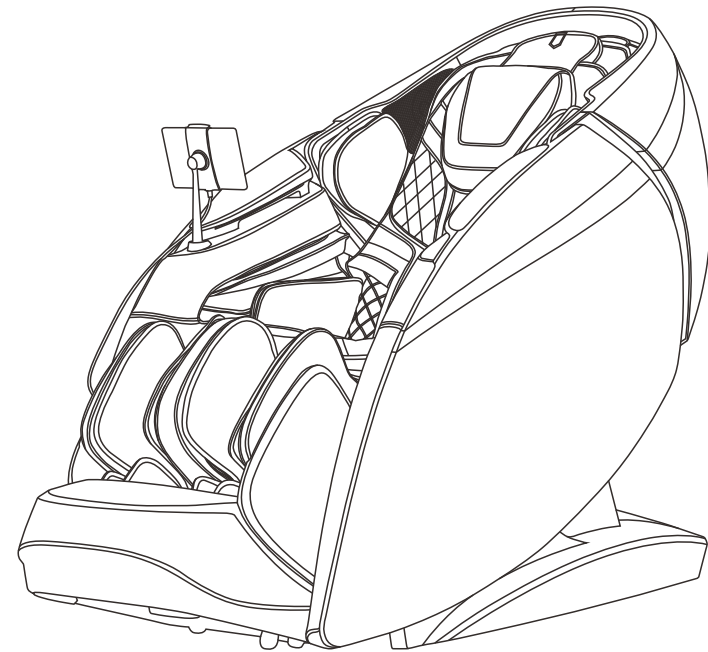

Thank you for purchasing this product. Please read this manual instruction carefully in order to know how to use this product correctly before operation. Please pay more attention to some important safety warning and keep this manual book properly for future use.

Note: Our company reserves the right to change and explain the design of the product. If there is some difference between the product function in market circulation and the description in the manual, it is a normal update of the product, and our company will not inform you otherwise. The specific product function and color shall prevail in kind.

## CONTENTS

### Before use

---

Safety precautions	02-04
Installation parts	05-07
Place massage chair	08-09
Before use	10-11
Product structure	12-18

### Usage method

---

Operation Instructions	19-53
Massage close	53

### Maintain

---

Cleaning and Maintenance	54
--------------------------	----



### Important

---

Troubleshooting	55
Product Specifications	56

## Safety Precautions must be observed

- Please read all relevant instructions carefully before use.
- The notes marked here will help you to use the product safely and correctly.
- In order to clearly indicate the extent of harm and damage, precautions are divided into **"Warning"** and **"Caution"** that may be caused by incorrect use. Both of them are important for safety and must be followed.

 <b>Warning</b>	Indicates that serious injury or death may result from improper use.
 <b>Caution</b>	Indicates that misuse may cause minor injury or property damage.

- Please pay attention to the symbol before each safety item.

 <b>Forbidden</b>	Absolute prohibition
--	----------------------

### The following populations should not use this product

 <b>Forbidden</b>	<ul style="list-style-type: none"> <li>■ The device is not intended for use by persons (including children) with physical disabilities, sensory or neurological impairments or who lack experience and common sense, unless they are supervised and instructed in the use of the device by those responsible for their safety. Children must be supervised to ensure they do not play with instruments.</li> <li>■ Patients with osteoporosis.</li> <li>■ Patients with heart disease or wearing electronic medical devices such as a pacemaker.</li> <li>■ People who have a fever.</li> <li>■ Pregnant women or women on their menstrual period.</li> <li>■ Patients who are injured or have a skin disease.</li> <li>■ When unsupervised, any children are under the age of 14 and those unconscious are not allowed to use this product.</li> <li>■ People who are told by their physicians to have rest or who feel unwell.</li> <li>■ People whose bodies are wet are forbidden to use this product.</li> <li>■ This product has a hot surface. Persons insensitive to heat must pay attention when using this product.</li> <li>■ If the supply cord is damaged, to avoid danger, it must be replaced by a professional from the manufacturer, its maintenance department or similar department</li> </ul>
---	---

## Safety Precautions must be observed

<b>Important safety warnings</b>	
 <b>Warnings</b>	<ul style="list-style-type: none"> <li>■ Do not allow children to touch any movable part of this product.</li> <li>■ Use the well-grounded power supply unit suitable for this product.</li> <li>■ Pull out the plug after use or before cleaning to avoid any physical injury or damage to the product.</li> <li>■ Operate this product as instructed in this manual.</li> <li>■ Do not use any parts or accessories which are not recommended.</li> <li>■ Do not use this product outdoors.</li> <li>■ Please read the Operation Instructions carefully before operation.</li> <li>■ Never use this product for any other purpose not listed herein.</li> <li>■ 20 minutes of usage each time is recommended.</li> <li>■ Do not use this product if the cover or leather is broken or damaged.</li> <li>■ Do not drop anything into this product.</li> <li>■ Never fall asleep while using this product.</li> <li>■ Do not use this product if you are drunk or feel unwell.</li> <li>■ Do not use this product within one hour after a meal.</li> <li>■ Do not use this product with excessive force to avoid any injury.</li> </ul>



### Safety precautions

 <b>Caution</b>	<ul style="list-style-type: none"> <li>■ Check whether voltage is consistent with the specification of this product.</li> <li>■ Never insert or pull out the plug with a wet hand.</li> <li>■ Do not let water flow into this product to avoid electric shock or cause damage to this product.</li> <li>■ Do not pull the power cord when plugging or unplugging it. Rough handling is forbidden.</li> <li>■ Do not damage the wire or modify the circuit of this product.</li> <li>■ Do not clean live parts of this product with a wet cloth such as a power switch and plug.</li> <li>■ Be away from this product in case of power failure to avoid any injury if power is restored suddenly.</li> <li>■ Stop using this product at once while it works abnormal, and consult your local supplier.</li> <li>■ Stop using this product if you feel unwell, and consult your health care practitioner.</li> </ul>
--	--

### Storage conditions

 <b>Caution</b>	<ul style="list-style-type: none"> <li>■ Storage room temperature: 41°F to 104°F.</li> <li>■ Relative humidity (RH) between 20% and 80%; free of corrosive gases, and a well-ventilated room.</li> </ul>
--	--

## Safety Precautions must be observed

<b>Product service and maintenance</b>	
 <b>Caution</b>	<ul style="list-style-type: none"> <li>■ This product should be maintained by the service center designated by the manufacturer only. No user should disassemble or maintain it without permission.</li> <li>■ Do not forget to turn off the main power switch after usage.</li> <li>■ Do not use this product if the power socket becomes loose.</li> <li>■ If this product will be left unused for a long period of time, it is necessary to roll up the power cord of this product and store this product in a dry and dust-free environment.</li> <li>■ Do not store this product at a high temperature or near open flame. Avoid prolonged exposure to direct sunshine.</li> <li>■ Please clean this product with dry cloth. Never use thinner, benzene or alcohol.</li> <li>■ The mechanical components of this product are specially designed and manufactured, so no special maintenance is needed.</li> <li>■ Do not use a sharp object to stab at this product.</li> <li>■ Do not roll or pull this product on any uneven ground. Instead, it should be lifted before moving.</li> <li>■ Please use this product intermittently. Do not keep it working continuously for a long period of time.</li> </ul>
<b>Operating environment</b>	
 <b>Caution</b>	<ul style="list-style-type: none"> <li>■ Do not use this product in a very moist environment such as the bathroom.</li> <li>■ Stop using this product immediately when the ambient temperature changes sharply.</li> <li>■ Do not use this product in any heavily-dusty or caustic environment.</li> <li>■ Do not use this product in a small space or a place without good ventilation.</li> </ul>
<b>Solutions to ordinary malfunctions</b>	
 <b>Caution</b>	<ul style="list-style-type: none"> <li>■ If the motor sounds during operation of this product, this is the normal operation sound.</li> <li>■ If the controller cannot work normally, check whether the plug and the power socket are connected reliably, and whether the power switch is turned on.</li> <li>■ If the rated working time is over, this product will automatically activate the power-off button; If this product keeps operating for a long period of time, the temperature protector will stop this product automatically. The product can be used again after half an hour.</li> </ul>

## Installation Parts

### Calf Installation Instructions

1. After power-on, lay the backrest frame down with the remote control.
2. Insert the harness connector and the air pipe on the side of the steel frame respectively into the position corresponding to the armrest (Figure 1).
3. Lift the armrest with inserted air pipe and wire, and hang all hooks to the armrest on both sides of the steel frame (Figure 2).

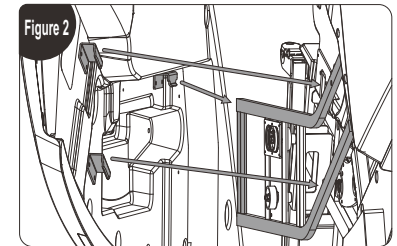
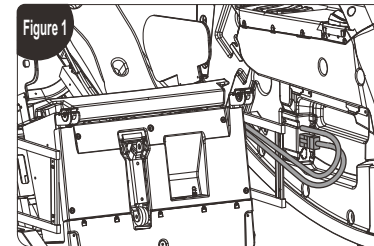

4. Put the roller at the rear end of the armrest against the surface of the armrest fixture (Figure 3) and lower the armrest backward and downward. Then push the armrest backward, and finally lock it with two M5 screws (Figure 4);

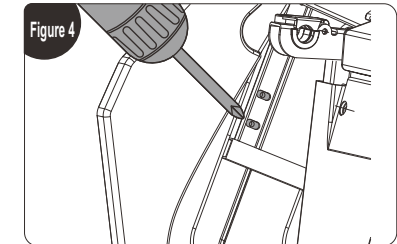
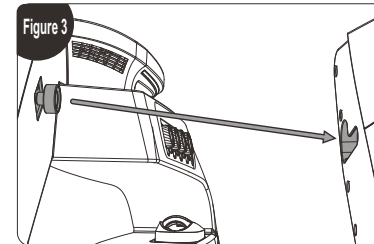

## Installation Parts

### Calf mechanism installation instructions

- 1、Insert the cable and air pipe of the calf mechanism, respectively, into the sockets at the front of the steel frame assembly (Figure 1).
- 2、After the connection is completed, open the calf mechanism fixing covers on both sides of the steel frame assembly (Figure 2).
- 3、Raise the calf mechanism and put it into the slot and cover the fixing cover and finally fix it in place with 2 M4 screws (Figure 3).

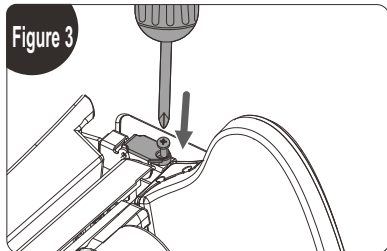
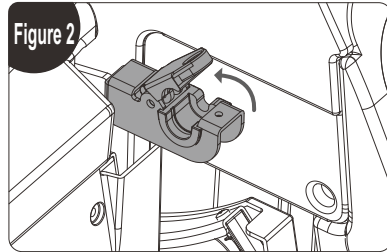
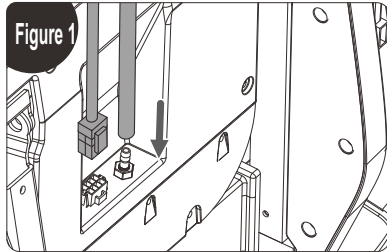

## Installation Parts

### Installation instructions for touch screen remote control holder

- 1、Align the holder with the front hole of armrest (right) and lock it with M5 screws (Figure1);
- 2、Align the holder trim with the holder and press down along the holder rod to the end. (Figure 2)
- 3、After the entire holder is installed, shake the holder gently to check whether it is firmly installed; holder installation is complete. (Figure 3)

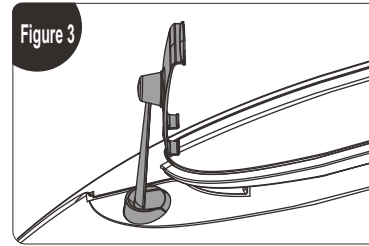
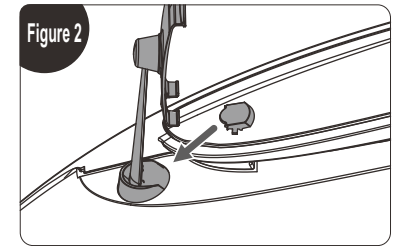
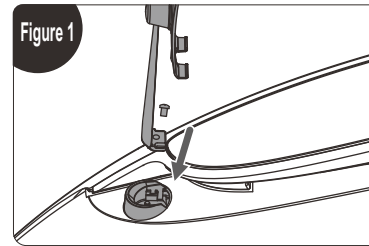

## Place massage chair

### Installation placement

**Make sure there is enough space for the massage chair can be tilted at least 4inches.**



Do not expose the massage chair directly to high temperature environment due to sunlight (such as: in front of heating equipment), and place it to where can avoid high temperature and direct sunlight. It is recommended to lay a soft cushion for long-term use in a designated location. When laying the cushion, the size of the cushion should be enough to cover the range where the machine touches the floor and the range where your feet touch the floor.

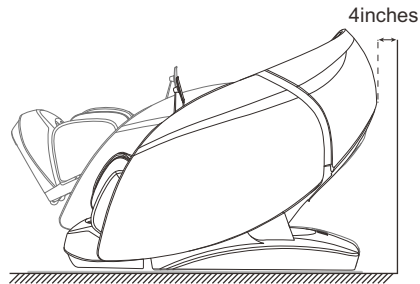

### Product lift instruction

**Require team work to lift and move the chair to avoid injury.**



1. Please lift the massage chair to move it on vulnerable ground such as wooden floor.  
2. When moving on a similar wooden floor, it is recommended to lift it. Avoid damage to the casters. When the floor is lifted and moved to the designated position, be careful to keep your hands out of the way to avoid injury, and be careful of your feet being crushed. Do not let go of the unit until the unit is completely flat, the floor may be damaged, therefore, it is recommended to place mats, etc. on the floor.

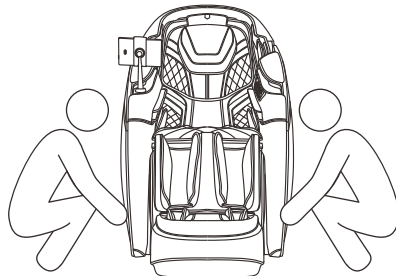

## Place massage chair

### Move method

**Use the rear casters to move the massage chair. Move the chair by tilting it down and backward about 45° as shown in the diagram.**

**NOTE: Excessive force to tilt will cause the chair to tip over completely and product damage.**



1. Before moving, please shut down the machine properly to reset the whole machine, and then cut off the power.
2. Please keep the chair vacant when moving. (People, pets or clutter will not be able to stay on the chair.)
3. When moving, do not cross a drop barrier higher than 2mm or a gap greater than 5mm.
4. When using casters to move this product, single continuous movement is not supported; if the distance exceeds 164ft meters, please make this product move slowly and evenly.

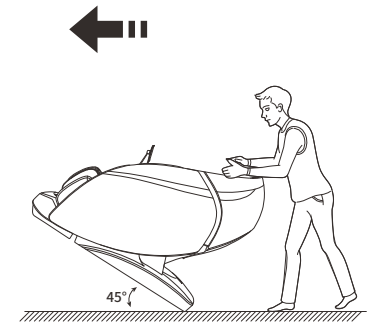

### How to disassemble and use headrest cushion and backrest cushion

Using a headrest cushion can reduce the intensity of kneading massage on the neck and shoulders, and you can decide whether to use a headrest cushion according to your needs (recommended to use a headrest cushion). The backrest cushion and the backrest are connected by a zipper (1), and the headrest cushion and the backrest cushion are connected by a zipper (2).

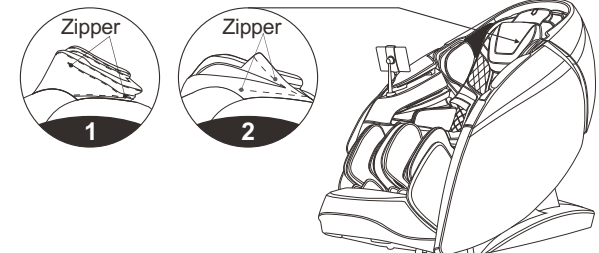

## Before use

### Check around

Make sure that there are no people, pets and other objects around the unit.

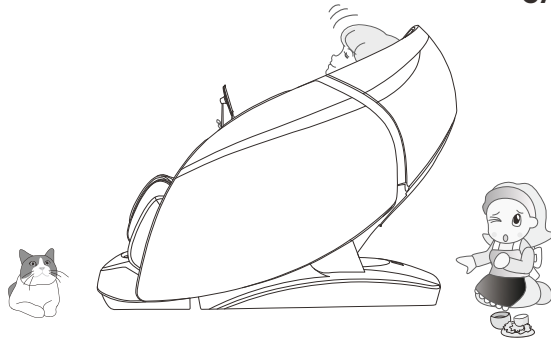

### Make sure there are no foreign objects in the gaps of the machine

Before massaging, make sure that no foreign objects are caught in the legs, feet, etc.

Under no circumstances allow hands, feet, and head to penetrate into the area between the lower leg mechanism and main body, or the area between the armrest and the capsule.

Under no circumstances should hands, feet, or head sink under the fabric or leather covering of the massage area.

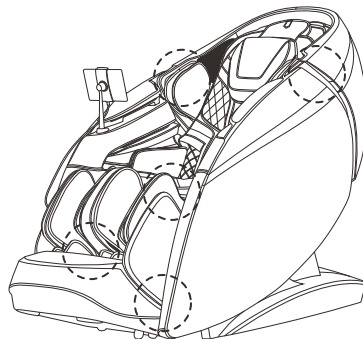

## Before use

### Turn on the power

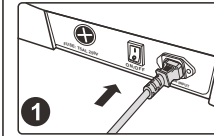

1 Plug in power cord

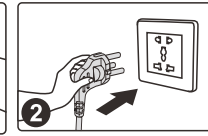

2 Schematic diagram of power on

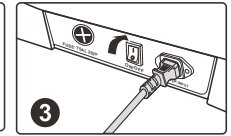

3 Turn on the power switch ("I" position)



- Please check the power cord and plug for damage before use.
- Please supply power to this product in accordance with the working power requirements of this product's calibration.
- It is strictly forbidden to use a power supply other than the nominal power supply of this product.
- It is strictly forbidden to connect various power conversion devices without authorization to supply power to this product.

## Product Structure

### Description of Components

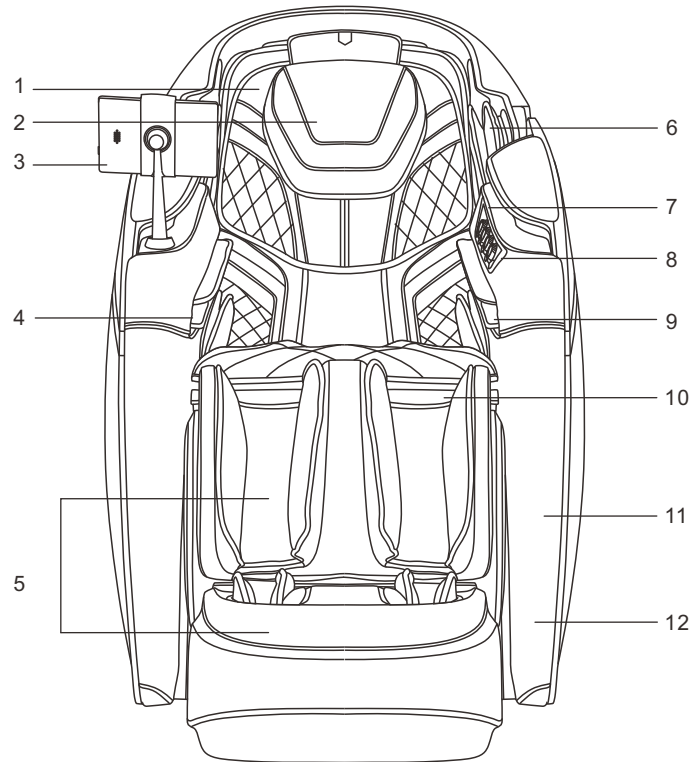

- 1. Large head cushion
- 2. Small head cushion
- 3. Remote controller
- 4. Arm air pressure
- 5. Leg massage unit
- 6. Shoulder air pressure
- 7. Ambient lighting on the armrest

- 8. Armrest Shortcut Keys
- 9. Health sensor
- 10. Shoulder mechanism  
Back cushion
- 11. Side panel
- 12. Under the armrest  
Ambient lighting

## Product Structure

### Schematic view of functional distribution

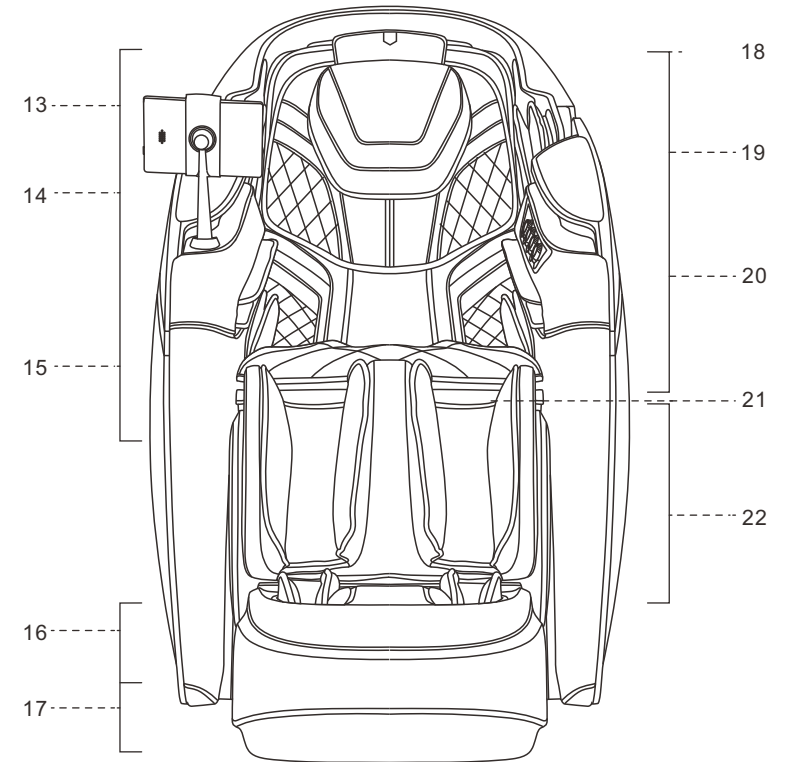

- 13.Shoulder**
  - Airbag massage
- 14.Arm**
  - Remote control holder
  - Voice control function
  - Arm simulator massage
- 15.Hand**
  - Airbag massage
- 16.Leg**
  - Airbag massage
- 17.Sole**
  - Roller massage
- 18.Both sides of the head**
  - Audio music playback

- 19.Arm**
  - Wireless charger
  - USB charging port
  - Arm simulator massage
- 20.Head and neck to bottom**
  - Dual mechanical core
  - Heating massage
- 21.Shoulder, back, waist, abdomen**
  - Heating function
- 22.Leg**
  - Air sac massage
  - Kneading function
  - Calf movement massage



## Product Structure

### How to use the shawl

- It is provided with a unique shawl assembly, with innovative heating functions on the shoulder, back, waist and abdomen and heating with graphene. Users can place the shawl at different massage positions according to massage requirements. When the shawl assembly is placed at the shoulder position, it will heat the acupoints such as Bingfeng, Tianzong, Yunmen and Qihu around the shoulder and clavicle by graphene heating, effectively relieving symptoms such as scapulohumeral periarthritis and cough, and removing cold and moisture from shoulder joints.
- When the shawl assembly is placed on the abdomen and back (dual-purpose), through graphene heating, it plays the role of dispelling cold and relieving pain, warming channels and removing blood stasis in the back and abdomen, distributing Qi and blood of the back and abdomen meridian, alleviating the symptoms such as irregular menstruation and dysmenorrhea for women, relieving low back pain and kidney discomfort, warming intestines and stomach and clearing intestinal cold, with a good effect on some people with deficiency of qi and deficiency of spleen and stomach.

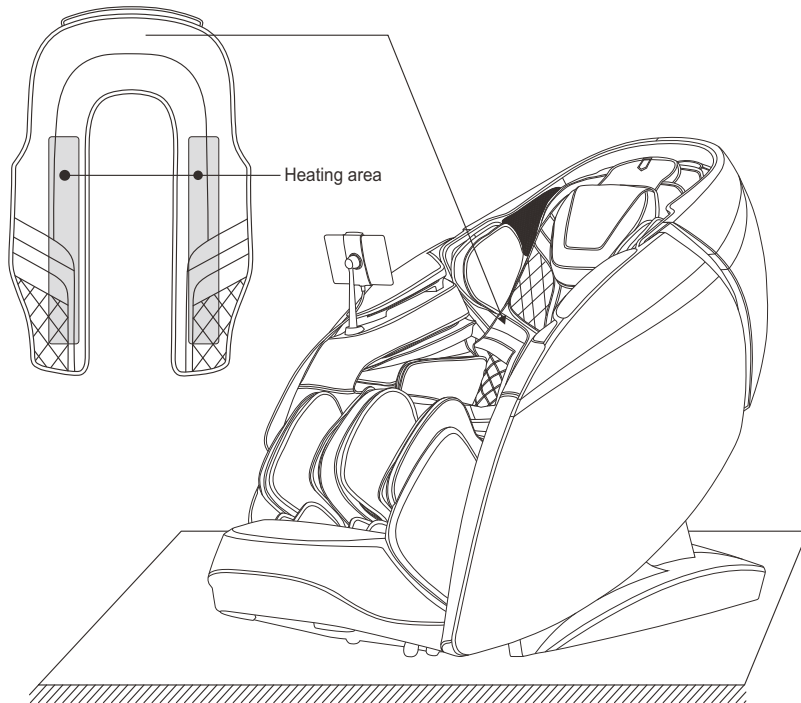

## Product Structure

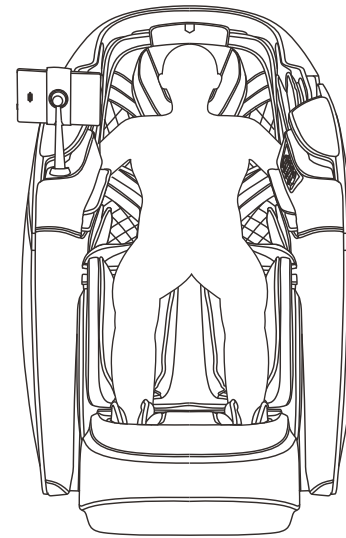

Schematic diagram  
of use on back and waist

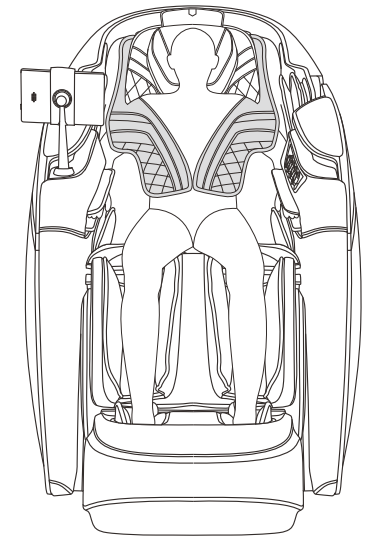

Schematic diagram of use  
on shoulder and abdomen

## Product Structure

### Remote controller keys instruction

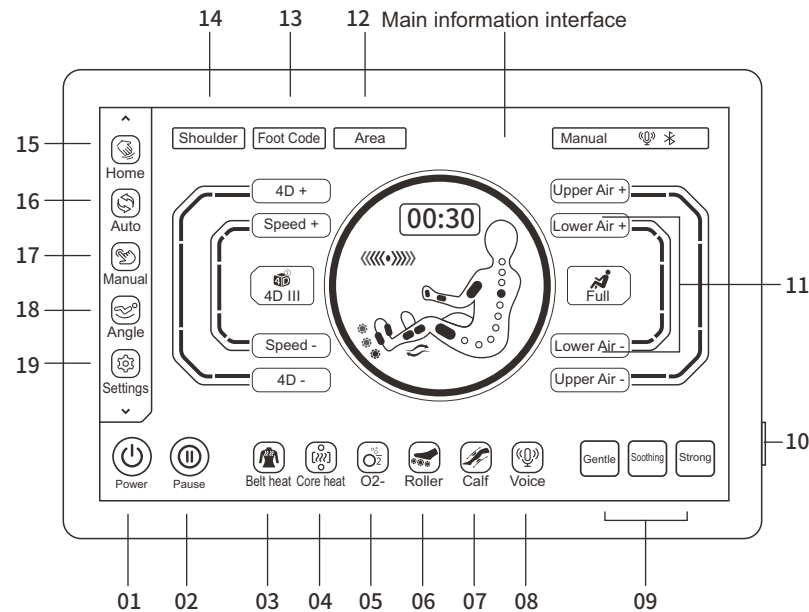

- 01.On/off touch key: Enable or disable the massage chair function
- 02.Pause key: Pause the massage or exit from pause massage
- 03.Shoulder mechanism heating key: turn the shoulder mechanism heating function on/off.
- 04.Mechanical core heating key: Turn the mechanical core heating function on/of
- 05:O2-Ion key: Turn the O2-Ion function on/of
- 06.Sole roller key: Enable or disable the sole roller function
- 07.Calf kneading key: Enable or disable the calf kneading function.
- 08.Voice control key: Enable or disable the voice control function.
- 09.Intensity selection key: Select one from different automatic massage intensities.
- 10.Button on/ff key: Turn on or off the massage chair.
- 11.Lower body air pressure adjustment key: Adjust the Lower body air pressure.
- 12.Massage range key: Choose corresponding massage part
- 13.Foot size selection key: Select the suitable foot size.
- 14.Shoulder position adjustment key: Regulate shoulder position and confirm massage criterion.

## Product Structure

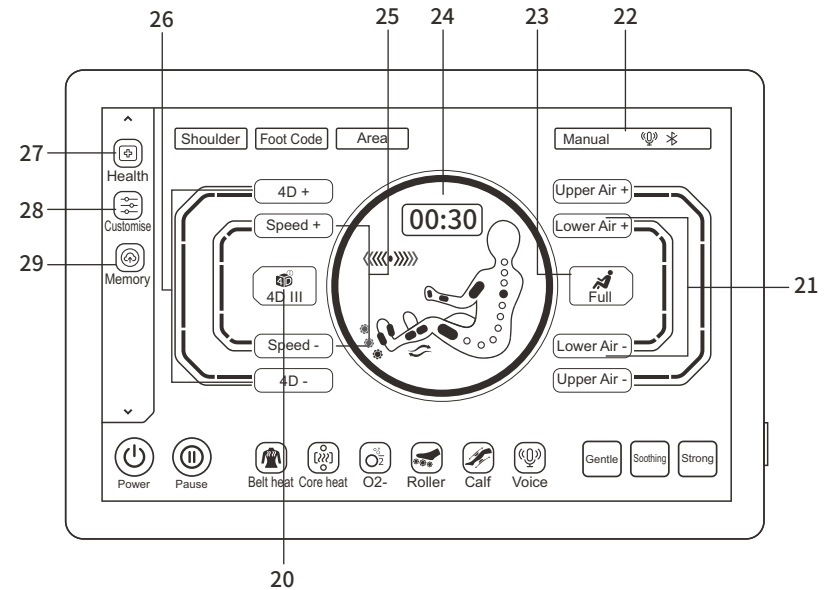

- 15.Current status key: Enter to view current massage chair status
- 16.Automatic function menu key: Enter to select automatic massage program.
- 17.Remote function menu key: Enter to remotely set the massage function
- 18.Seat adjustment menu key: Enter the sitting posture adjustment interface to select sitting posture angle.
- 19.Setting menu key: Enter the setting menu interface
- 20.Massage technique selection key: Select the massage technique
- 21.Upper body air pressure intensity key: Adjust upper body air pressure intensity.
- 22.Status display bar key: Display the massage program status information.
- 23.Air massage selection key: Select air position.
- 24.Time adjustment menu key: Adjust the massage time.
- 25.Massage speed key: Adjust the massage speed.
- 26.4D intensity key: Adjust 4D intensity
- 27.Health detection menu key: Enter the health detection interface
- 28.Custom menu key: Enter the custom interface.
- 29.Storage menu key: Enter the storage interface.

## Product Structure

### Armrest shortcut key description

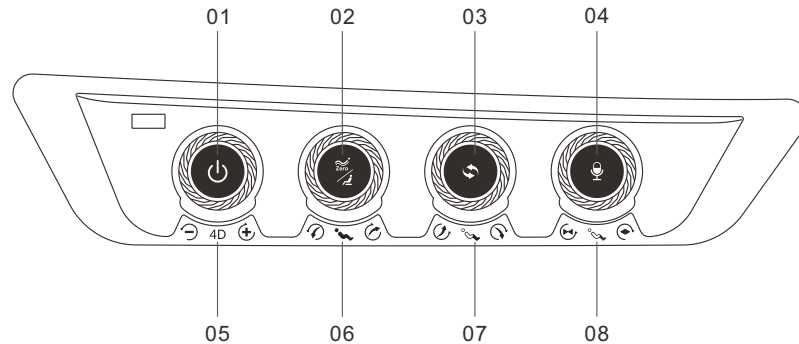

- 01. On/off key
  - Long press this key for 3 seconds to turn on or off the massage chair. After the massage is turned on, press the pause/run key briefly.
- 02. Zero-gravity key
  - Press this key to adjust the zero-gravity angle automatically, and zero-gravity at two levels can be adjusted. Long press the key for 2 seconds to restore the angle to the initial angle, lower the calf to the lowest and raise the backrest to the highest position.
- 03. Automatic mode key
  - Automatic massage program switching
- 04. Voice key
  - Long press for 3 seconds to turn voice assistant function on/off. Short press the key to wake up the voice assistant.
- 05. 4D intensity knob key
  - Turn the knob clockwise to enhance the 4D intensity, and turn the knob counterclockwise to weaken the 4D intensity.
- 06. Linkage up/down knob key
  - Turn the backrest clockwise to rise slowly. The calf frame falls slowly and stops rotation. The backrest and calf stop simultaneously, and the calf checks foot length automatically
  - Turn the backrest counterclockwise to fall slowly. The calf frame rises slowly and stops rotation. The backrest and calf stop simultaneously, and the calf checks foot length automatically.
- 07. Calf up/down knob key
  - Turn the calf clockwise to rise slowly and stop rotation, the calf stops and checks foot length automatically.
  - Turn the calf counterclockwise to fall slowly and stop rotation, the calf stops and checks foot length automatically
- 08. Foot stretching knob key
  - Turn the foot mechanism clockwise to stretch slowly and stop rotation, and the foot mechanism stops.
  - Turn the foot mechanism counterclockwise to shorten slowly and stop rotation, and the foot mechanism stops.

## Operation Instructions

### I. Start massage

1. Press the remote controller side button on/off key or long press the armrest on/off key

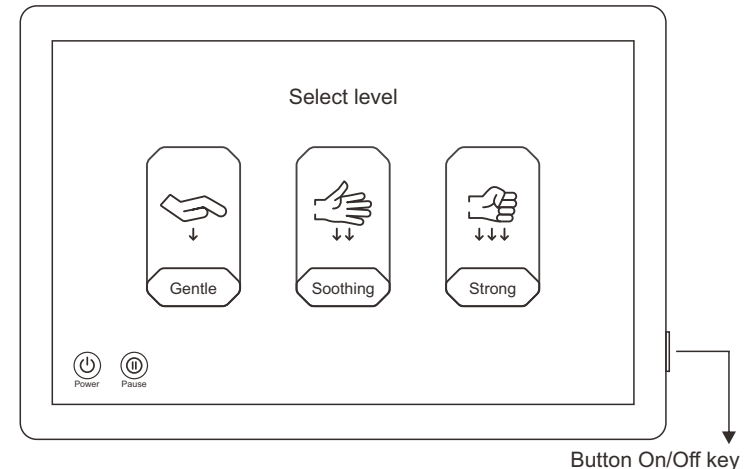

Press this key to turn the equipment on

2. After the system is started, select the massage intensity by clicking on any one of the Gentle , Comfort or Strong keys on the remote controller to turn on the massage chair and enter the lying state. If it is not selected within 5 minutes, the massage chair will turn off automatically.

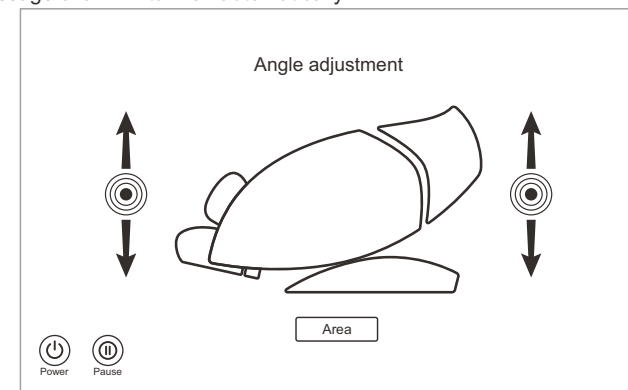

3. For automatic angular adjustment, select the automatic program, then the massage chair will be automatically adjusted to zero-gravity angle, and wait until its adjustment is completed. To skip a step, press the skip key **Skip** to go directly to the next step.

## Operation Instructions

4.Wait until body shape detection is completed, or you can press the skip key **Skip** to skip detection and start massage directly.

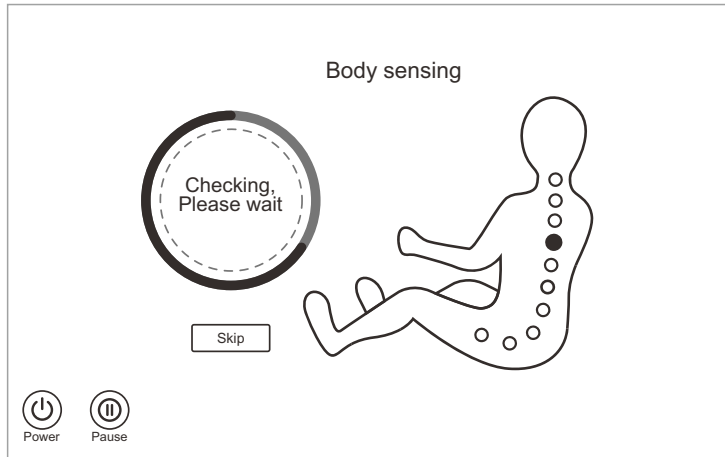

For fine adjustment of shoulder position, after body shape detection, the remote controller or a voice prompt will remind the user of fine adjustment of shoulder position. If the massage roller stops at the shoulder position, directly press the OK key **OK** to start massage. If not, use the Up key **▲** and Down key **▼** to adjust the massage roller to the shoulder position, and then press the OK key **OK** to start the massage. If no operation is made within 20s, directly default the current massage roller position for the shoulder position and start massage.

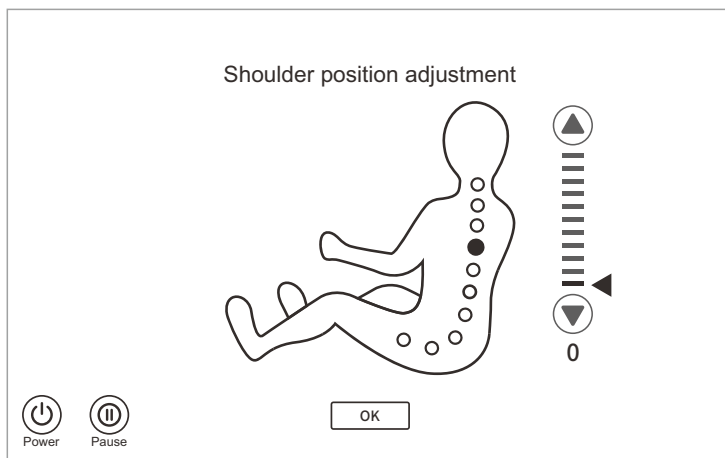

## Operation Instructions

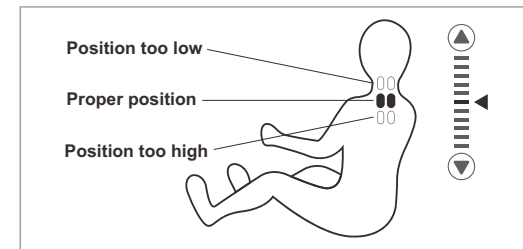

### II. Pause function (please use this function after the equipment is turned on)

After the massage chair is turned on, press the pause key **⏸** to enter the pause state, then all massage functions will be suspended, and press the pause key **⏸** again to resume the previous massage state. Note: In the pause state, all functions do not work except shutdown.

### III. Automatic program (please use this function after the chair is turned on)

Automatic program selection

- (1) Select the Automatic key **🔄** in the left menu bar to enter the automatic selection interface.
- (2) In the automatic program selection interface, there are 20 automatic program options available: Total Relax, Stress Release, Full Airbag, Chinese Massage, Thai Massage, Meridian Treatment, Neck & Shoulder Care, Waist Care, Waist & Buttock Shape, Leg & Foot Relieve, President Cosy, Keep Fit, Superior Enjoyable, Office Regimen, Health Recharge, Energy Boost, Lunch Break, Sweet Dream, Brain Refresh, Rejuvenate.
- (3) Select the desired automatic massage program and click to start massage.

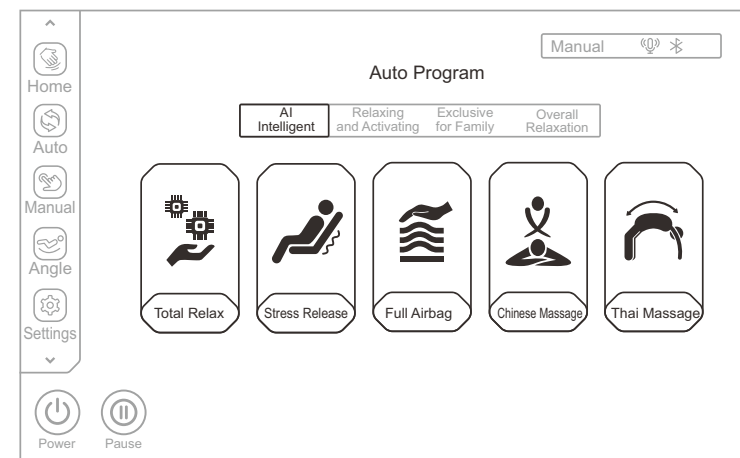

Schematic diagram of automatic massage program selection

## Operation Instructions

Massage scenes(AI Intelligent)	
Function	Description
Total Relax	The upper mechanical core is used to massage the neck, shoulders and Fengchi acupoint by kneading, and then work with tapping and Shiatsu to massage the whole body. The lower mechanical core is used to massage the waist and hip by kneading and tapping. The two mechanical cores coordinate to assist to relax the whole body muscle and alleviate fatigue.
Stress Release	Massage neck, shoulders and Dazhui acupoint mainly by kneading to relieve systemic pressure.
Full Airbag	Apply air massage on the whole body, with the sole roller and calf kneading massage. With the calf stretching function, the mechanical wave operates automatically with hand pressure.
Chinese Massage	By means of Traditional Chinese medicine massage technique mainly, apply 4D massage on the back and waist so as to promote the blood circulation of the back and waist, soothe the meridians and relieve the blockage of the back and waist through massage
Thai Massage	Mainly with air pressure clamping legs, hands, shoulders and hips, and then calves, backrest electric push rod with air pressure to adjust the various different angles to achieve stretching traction Role, while the movement of 3D massage hand holding against waist, so that the body is in the Thai stretching state. Note: Stretching amplitude is divided into three levels, choose gentle stretching amplitude lowest, choose soothing when the stretching amplitude moderate, choose strong when the maximum stretching amplitude.

## Operation Instructions

Massage scenes(Relaxing and Activating)	
Function	Description
Meridian Treatment	Massage the shoulders, neck and back and waist by means of kneading, tapping and Shiatsu techniques to the effect of meridian treatment.
Neck & Shoulder Care	Massage the neck and shoulders by means of kneading and stretching techniques mainly, and also the upper back by medical massage, and then press the Jianjing acupoint to relieve cervical spondylosis and achieve the effect of relaxing the muscles of the neck and shoulders.
Waist Care	Massage the waist by kneading, kneading&tapping, tapping, and then perform 4D massage of the waist
Waist & buttock Shape	Massage buttocks by kneading and medical massage mainly, and then through tapping and kneading, deeply massage buttocks and perineum, to relax the hip muscles and lift the hip, which is suitable for women massage, and also for men for maintenance of prostate.
Leg & foot Relieve	Massage the shoulders and waist by means of kneading, tapping, kneading and tapping mainly, apply air massage on the calves and feet for squeezing massage, allowing more soothing calf and foot massage.

## Operation Instructions

Massage scenes(Exclusive for Family)	
Function	Description
President Cosy	Massage the shoulders, neck, back and waist by means of kneading, tapping, kneading and tapping mainly, to relieve fatigue, promote blood circulation, and release stress by such deep massage. It is suitable for men, and the massage intensity is moderate.
Keep Fit	Massage the shoulders, neck, waist and hips by means of kneading and Shiatsu techniques, through the massage on the whole body, to relax the body and mind, and enjoy the queen-level treatment. It is suitable for women. Massage intensity is gentle.
Superior Enjoyable	Apply gentle massage on the whole body, with the sole roller and calf kneading massage. Calf stretching function is canceled, suitable for the elderly and people suffering stress on back.
Office Regimen	Massage the shoulders, neck and waist by means of kneading, tapping, kneading and tapping techniques mainly, to relieve shoulder and neck pain, improve lumbar muscle soreness and maintain lumbar spine through such deep massage. It is suitable for office white-collar and sedentary people.
Health Recharge	Deeply massage the whole body by means of kneading, tapping and Shiatsu techniques, to promote blood circulation throughout the body and prevent blood clots. It is suitable for people who live at home for a long time and do not like to go out, and the massage intensity is moderately gentle.

## Operation Instructions

Massage scenes(Overall Relaxation)	
Function	Description
Energy Boost	Deeply massage the whole body by means of kneading, tapping and Shiatsu techniques, to wake up the vitality of the human body and stimulate the energy.
Lunch Break	Massage the back and waist by means of kneading and tapping techniques, and press the Shenyu acupoint, to improve the quality of lunch break, so that the user is more energetic in afternoon work.
Sweet Dream	Massage the shoulders, neck, back and waist by means of kneading and medical massage techniques, and press the acupoints of Fengchi and Shenyu, to improve the sleep quality and help sleep. It is suitable for people suffering from poor sleep.
Brain Refresh	Massage the shoulders, neck and back and waist by means of kneading, 4D kneading and Shiatsu techniques to achieve a high degree of physical and mental harmony through deep massage. It is suitable for people who are mentally retarded and overused. The massage intensity is gentle.
Rejuvenate	Massage the back and waist mainly by tapping and kneading&tapping techniques to promote blood circulation, eliminate local muscle pain, accelerate lactic acid excretion, and rekindle human vitality

## Operation Instructions

### IV.remote program (please use this function after the equipment is turned on)



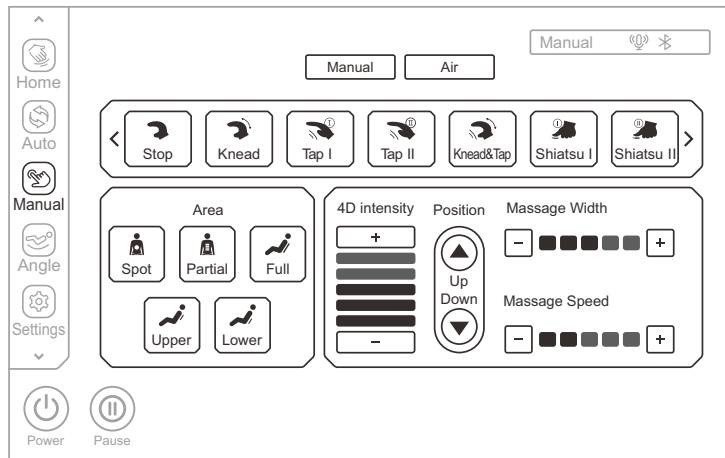

#### Remote program selection

Select the remote key  in the left menu bar and click to enter the remote menu to select massage technique, massage area, 4D intensity, massage hand adjustment, massage width, massage speed, air massage, air intensity and other massage functions.







1. In the massage technique menu, a total of 11 options are available, including kneading, Tap I, Tap II, kneading and Tap, Shiatsu I, Shiatsu II, shoulder grasp, 4DI, 4DII, 4DIII and 4DIV. (Note: Click the "leftward arrow <" and rightward arrow >" button in the remote adjustment menu to scroll left and right to display more massage techniques).





Remote program - Schematic diagram of technique selection

Function	Message roller adjustment
4D I 	Speed and strength.
4D II 	Speed and strength.
4DIII 	Speed, width and strength.
4DIV 	Speed, width and strength.

## Operation Instructions

Function	Message roller adjustment
Stop	Press this key to massage without any technique.
Knead 	The speed and strength can be adjusted.
Tap I 	The speed, width and strength can be adjusted.
Tap II 	The speed, width and strength can be adjusted.
Knead&Tap 	The speed and strength can be adjusted.
Shiatsu I 	The speed, width and strength can be adjusted.
Shiatsu II 	The speed, width and strength can be adjusted.
Grasp 	The speed and strength can be adjusted.

-Adjustable speed in five gears  
-Adjustable width in five gears  
-Adjustable intensity in five gears

Note: You can also click the massage technique key  in the "Home  interface to select the corresponding massage technique in the pop-up menu for massage (this function is a shortcut for switching massage techniques in the current status page of the remote program - technique adjustment).

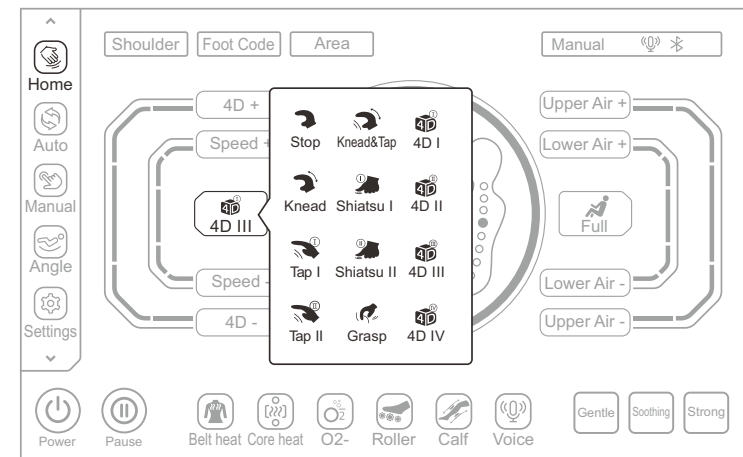

Current Status - Schematic diagram of technique selection

## Operation Instructions

2.The massage area menu has five options: Spot, Partial, Full, Upper and Lower. Select the corresponding massage area for massage.

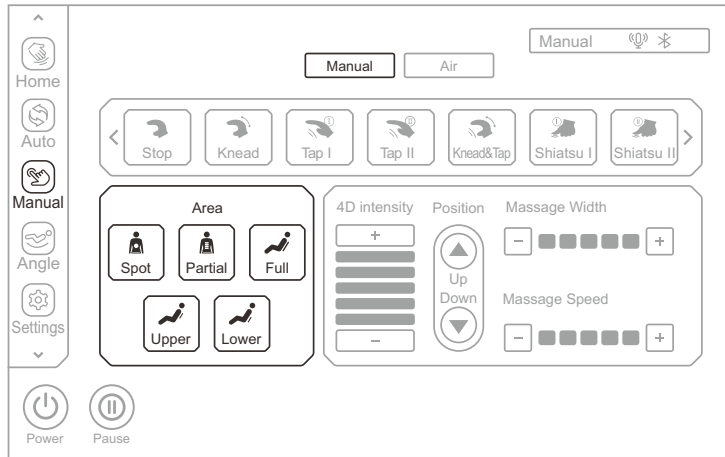

Remote program - Schematic diagram of massage area selection

Key	Description
	Fixed-point massage at fixed-point position.
	Small-scope local massage back and forth.
	Full back massage back and forth.
	Upper back massage back and forth.
	Lower back massage back and forth.

Note: You can also click the massage area key **Area** in the "Current Status" interface to select the corresponding massage area in the pop-up menu for massage (this function is a shortcut for switching massage areas in the current status page of the remote program - massage area).

## Operation Instructions

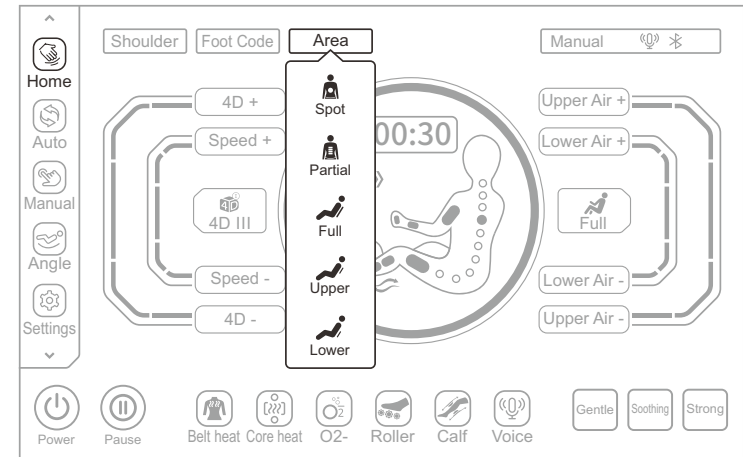

Current Status - Schematic diagram of massage area selection

3.You can adjust 4D intensity in the 4D intensity menu. There are 1~5 gears available for adjustment with 1 being the weakest and 5 being the strongest. The stronger the 4D intensity, the higher the massage roller ejection and the greater the massage strength. Select plus key **+** or minus key **-** to reduce the 4D intensity.

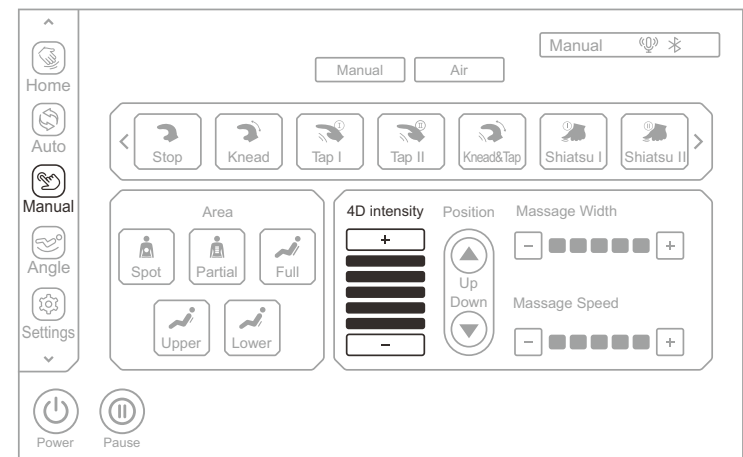

Remote program - Schematic diagram of 4D intensity



## Operation Instructions



Key	Description
	Press this key to increase 4D intensity which is adjustable from 1 to 5.
	Press this key to decrease 4D intensity which is adjustable from 1 to 5.

Note: You can also select the 4D intensity + key or 4D intensity - key in the "Home

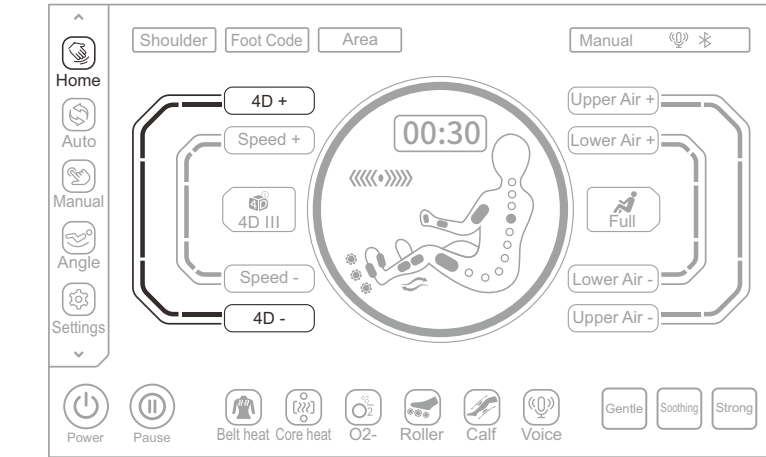

Current Status - remote program-4D intensity



Key	Description
	Press this key to increase 4D intensity which is adjustable from 1 to 5.
	Press this key to decrease 4D intensity which is adjustable from 1 to 5.

## Operation Instructions

4. For message hand adjustment, select the Up arrow or the Down arrow down to upwards or downwards fine-adjust the message hand position.

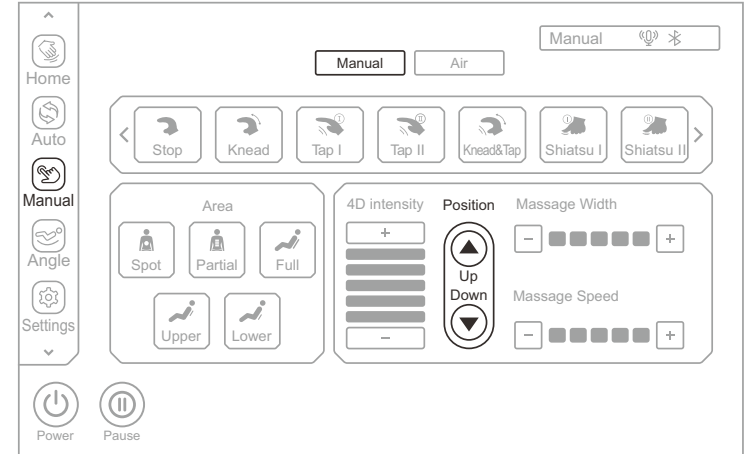

Remote program - Schematic diagram of message hand adjustment

5. For message width, as shown in the figure below, select the message width to adjust.

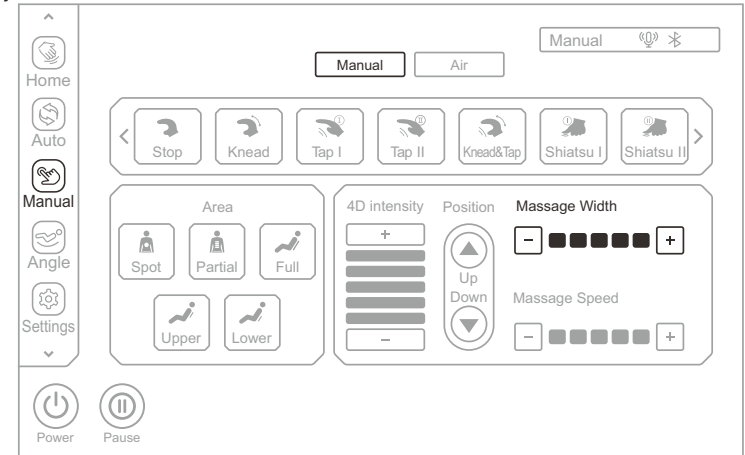

Remote program - Schematic diagram of message width

## Operation Instructions

- (1)The width can be adjusted only when the user enters the remote mode in selecting massage technique or massage area.  
 (2)The massage width is available from 1 to 5 gears, with 1 being the narrowest and 5 being the widest. Please use the following massage techniques: PattingI, Patting II, Finger PressingI, Finger Pressing II, 4D III and 4D IV.

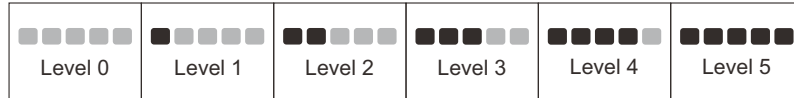

Key	Description
+	Press this key to increase massage width which is adjustable from 1 to 5.
-	Press this key to decrease massage width which is adjustable from 1 to 5.

- 6.For massage speed, as shown in the figure below, select the massage speed to adjust.

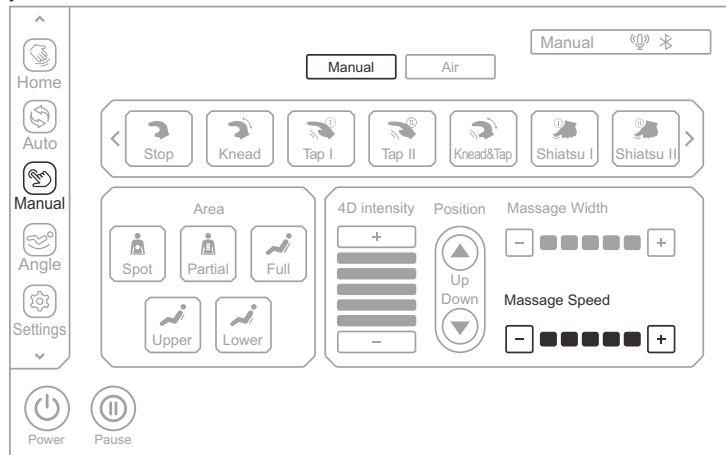

Remote program - Schematic diagram of massage speed

- (1)The speed can be adjusted only when the user enters the remote mode in selecting massage technique or massage position.  
 (2)The massage speed is available from 1 to 5 gears, with 1 being the fastest and 5 being the slowest. The speed cannot be adjusted when the massage technique stops.

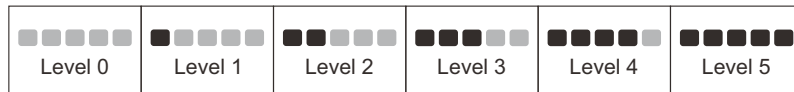

## Operation Instructions

Key	Description
+	Press this key to increase massage speed which is adjustable from 1 to 5.
-	Press this key to decrease massage speed which is adjustable from 1 to 5.

Note: You can also select the massage speed + key **Speed +** or massage speed - key **Speed -** in the "Home" interface to adjust the massage speed.

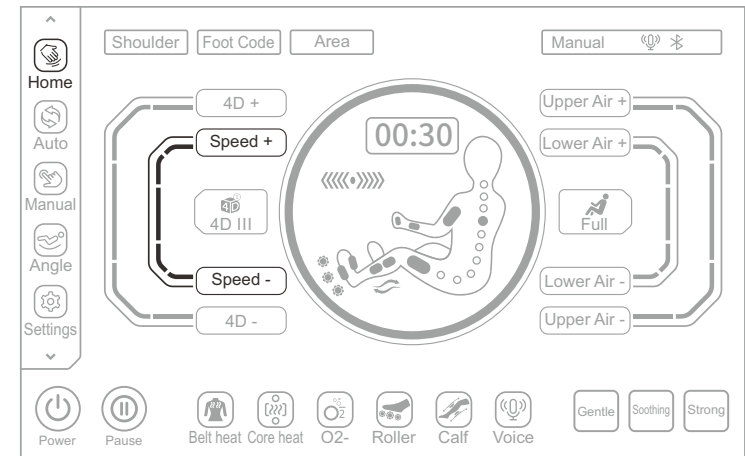

Current Status - Schematic diagram of massage speed

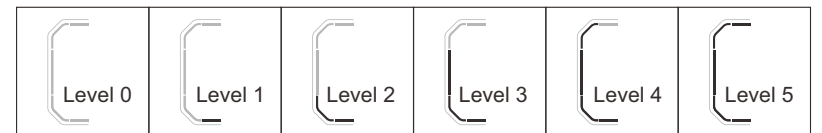

Key	Description
Speed +	Press this key to increase massage speed which is adjustable from 1 to 5.
Speed -	Press this key to decrease massage speed which is adjustable from 1 to 5.

## Operation Instructions

7. Air pressure massage, enter into the air pressure massage menu to choose the air pressure mode as shown in the following figure. Air pressure mode include upper body, lower body, full body air pressure, and off to close the air pressure function. And in the inner side of the arm with a hand roller massage function, when the whole body air pressure or upper body air pressure is turned on, the hand roller will automatically run with the operation of air pressure, which can relieve the stiffness of the arm muscle.

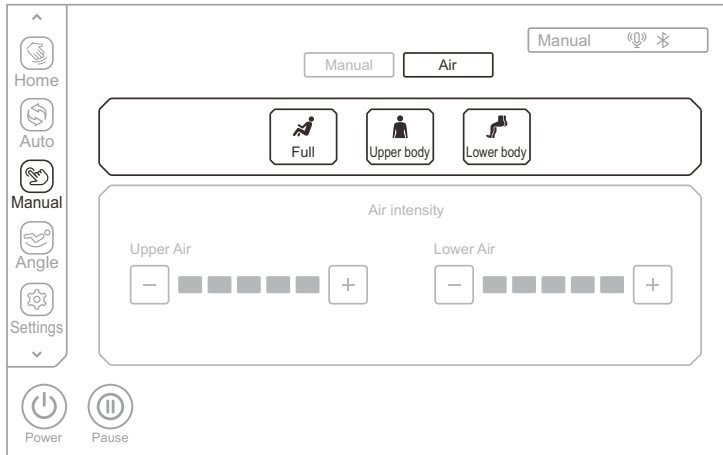

Remote program-Schematic diagram of air massage

Key	Description
	Press this key to enable or disable the whole body air massage function.
	Press this key to enable or disable the upper body air massage function.
	Press this key to enable or disable the lower body air massage function.

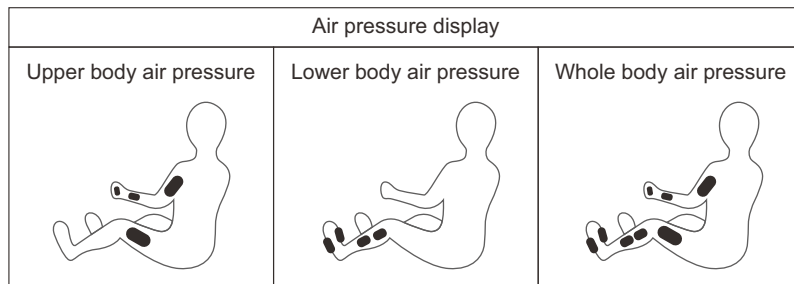

## Operation Instructions

Note: You press also air massage key in the "Home " interface, and select corresponding air mode in the pop-up menu. (This function is a shortcut to the air massage in the current status interface of the remote function - air massage.)

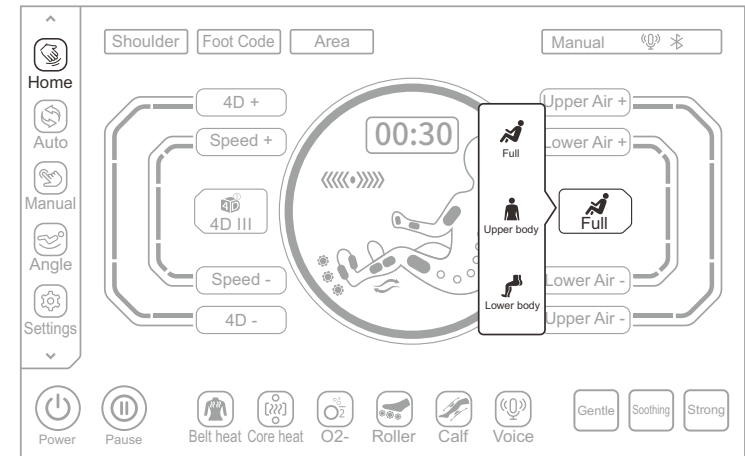

Current status - Schematic diagram of air massage

8. For air intensity adjustment, the air function shall be turned on so as to adjust the air intensity, with a total of five adjustable levels, with 1 being the weakest and 5 being the strongest.

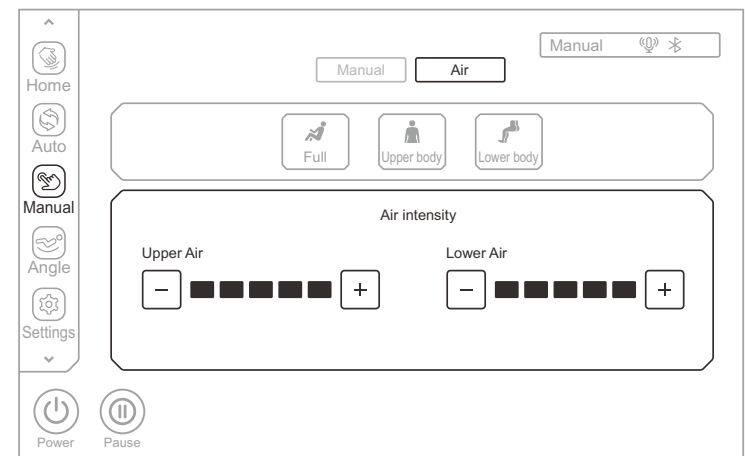

## Operation Instructions



Key	Description
<b>+</b>	Press this key to increase the air intensity which is adjustable from 1 to -5.
<b>-</b>	Press this key to decrease the air intensity which is adjustable from 1 to -5.

Note: Can select the upper body air pressure + key **Upper Air+** or the upper body air pressure - key **Upper Air-** in the "Home" interface to adjust the upper body air pressure intensity; can also select the lower body air pressure + key **Lower Air+** or the lower body air pressure - key **Lower Air-** to adjust the lower body air pressure intensity, the air pressure intensity is divided into 5 levels.

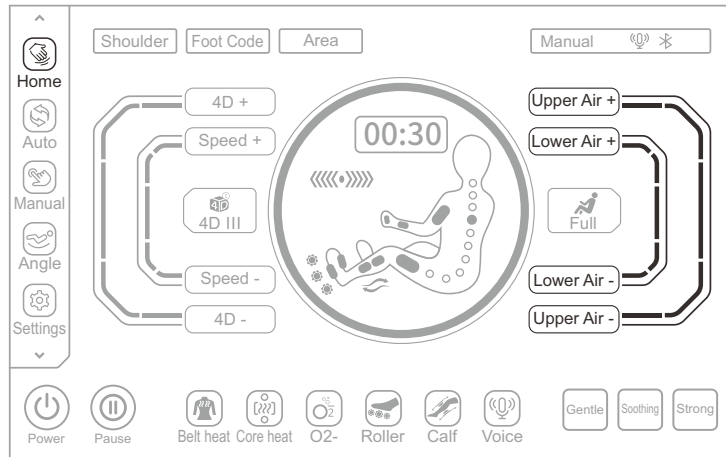

Current status - Schematic diagram of air intensity

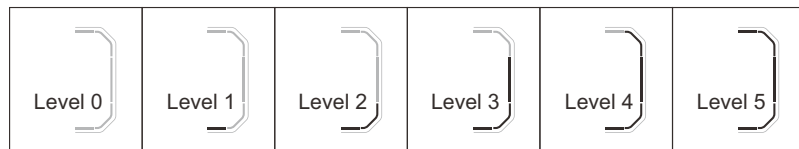

## Operation Instructions

Key	Description
<b>Upper Air +</b> <b>Lower Air +</b>	Press this key to increase the air intensity which is adjustable from 1 to -5.
<b>Lower Air -</b> <b>Upper Air -</b>	Press this key to decrease the air intensity which is adjustable from 1 to -5.

### V. Seat adjustment

Click the "Angle" button in the menu bar on the left side of the display screen to enter the angle adjustment interface, which includes leg rest telescoping, footrest telescoping, leg rest lifting, linkage lifting, backrest lifting, zero gravity I, and other massage functions.

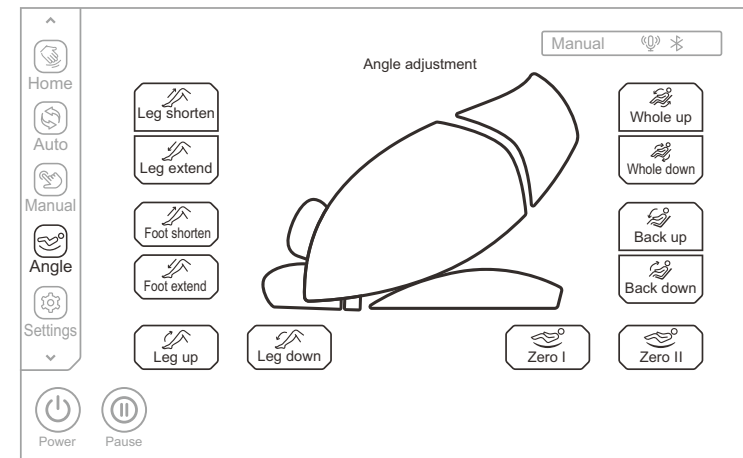



Schematic diagram of sitting posture adjustment

#### 1. Zero-gravity adjustment



Key	Description
<b>Zero I</b>	Zero-gravity 1 key: automatically adjust the position of leg unit and backrest unit to zero-gravity 1 position.
<b>Zero II</b>	Zero-gravity II key: automatically adjust the position of leg unit and backrest unit to zero-gravity II position.

## Operation Instructions



### 2. Telescopic adjustment of footrest

Key	Description
 Foot shorten	Footrest shortening button: Manually adjust the footrest to shorten; press and hold this button to move the footrest slowly upward, and release it to stop.
 Foot extend	Footrest extension key: Manually adjust the extension of the footrest; press and hold this button to move the footrest slowly downward, and release it to stop.



### 3. Leg unit extension/shortening adjustment

Key	Description
 Leg shorten	Leg unit shortening key: remotely adjust shortening of the leg unit; press and hold this key to move the leg unit up slowly and stop when released.
 Leg extend	Leg unit extension key: remotely adjust extension of the leg unit; press and hold this key to move the leg unit down slowly and stop when released.

### 4. Leg unit extension/shortening adjustment



Key	Description
 Leg up	Leg unit Up key: press and hold this key to slowly raise the leg unit, and release it to stop rising; after the leg unit rising action is completed, the leg unit will automatically detect the foot length.
 Leg down	Leg unit Down key: press and hold this key to slowly lower the leg unit, and release it to stop lowering; after the leg unit lowering action is completed, the leg unit will automatically detect the foot length.

### 5. Linkage lifting Angle adjustment

Key	Description
 Whole up	Linkage Up key: press and hold this key to slowly raise the backrest unit while slowly lowering the leg unit, and release it to stop raising the backrest unit or lowering the leg unit; after the linkage rising action is completed, the leg unit will automatically detect the body height.
 Whole down	Linkage Down key: press and hold this key to slowly lower the backrest unit while slowly raising the leg unit, and release it to stop lowering the backrest unit or raising the leg unit; after the linkage lowering action is completed, the leg unit will automatically detect the body height.

## Operation Instructions

### 6. Backrest unit angular adjustment

Key	Description
 Back up	Backrest unit Up key: press and hold this key to slowly raise the backrest unit and release it to stop rising.
 Back down	Backrest unit Down key: press and hold this key to slowly lower the backrest unit and release it to stop lowering.

### VI. Setting (please use this function after the equipment is turned on)

Click the "Settings"  button in the menu bar on the left side of the display to enter the setting interface, where you can view the product model, software version number, product serial number, and firmware version number. The interface includes language selection settings.

1. Product model, software version, product serial number, and firmware version show the information of current device.
2. Bluetooth (Operation Instructions for Bluetooth Speaker Play)  
Click Bluetooth switch to enable or disable the Bluetooth function. After pairing and connecting the sound source device with Bluetooth function (such as mobile phone, MID tablet, etc.) with the Bluetooth module of the massage chair, the music played by the sound source device can be wirelessly transmitted to the sound system of the massage chair through Bluetooth for music playing.
  - 1). Enter the smart device main menu. Open "Settings" and select the "Bluetooth" option. Open "Bluetooth", and Bluetooth will automatically "Search for a New Bluetooth Device".
  - 2). The smart device will search for the corresponding Bluetooth model (e.g. IMCM-XXXX). Click the "Match" button. If you are asked whether to match with the device, you just select "Match" to complete matching.
  - 3). Turn on "Music Player" in the smart device and select the song to play.

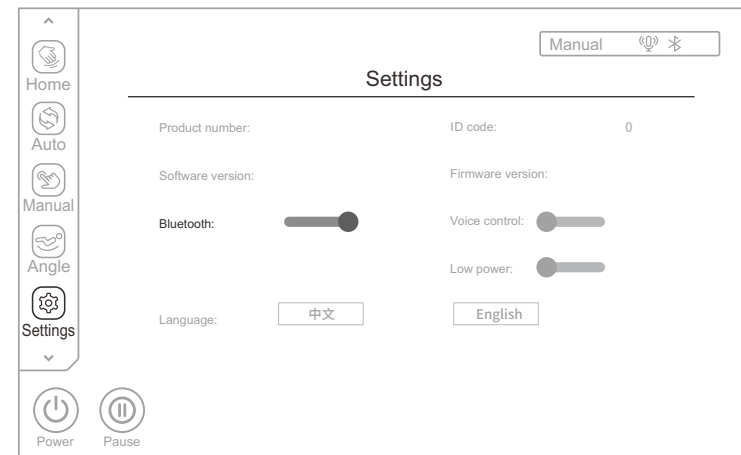

## Operation Instructions

### 3. Voice control

- (1) Near the right armrest, say "Hi Alice" or "Hey Alice" to wake up the voice assistant, or press the voice key  on the left armrest to wake up the voice assistant, and the voice assistant replies "I am here" to indicate that it has been awakened.
- (2) After waking up the voice assistant, please speak the command within 6 seconds to realize the function control of the massage chair. After the voice assistant responds to the command, you can continue to speak the command. The interval between two adjacent commands cannot exceed 6 seconds, otherwise the voice assistant needs to be re-awakened.

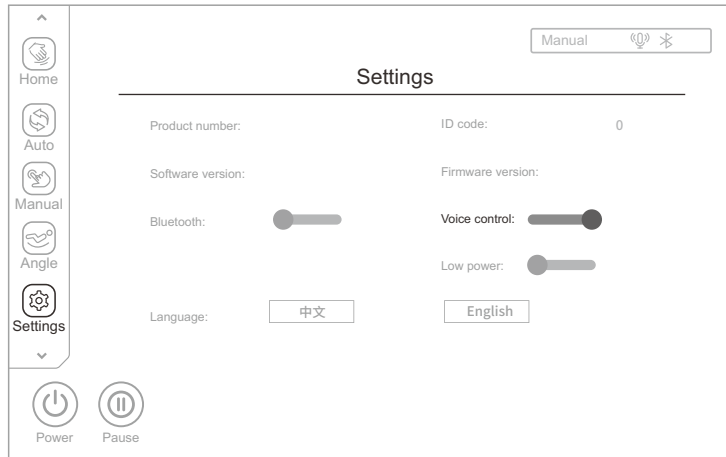

## Operation Instructions

Voice Control Entry		
Entry: "Hi Alice" or "Hey Alice". Answer: I am here.		
No.	Voice control entry	Answer entry
1	Massage on	Answer: Ok, Massage on
2	Massage close	Answer: Ok, Massage close
3	Total Relax	Answer: Ok, Total Relax
4	Energy Boost	Answer: Ok, Energy Boost
5	Sweet Dream	Answer: Ok, Sweet Dream
6	Neck & Shoulder Care	Answer: Ok, Neck & Shoulder Care
7	Lunch Break	Answer: Ok, Lunch Break
8	Thai Massage	Answer: Ok, Thai Massage
9	Open the air pressure	Answer: Ok, Open the air pressure
10	Close the air pressure	Answer: Ok, Close the air pressure
11	Up the seat position	Answer: Ok, Up the seat position
12	Down the seat position	Answer: Ok, Down the seat position
13	Change the other mode	Answer: Ok, Change the other mode
14	Go little down	Answer: Ok, Go little down
15	Go little up	Answer: Ok, Go little up

Note: commands 14 and 15 can only be used after command 13.

## Operation Instructions

### 4.Low-power mode switch

Low-power mode on: In a low-power state, the armrest shortcut keys, voice voice control functions can not be used, need to be used in the state of power on.Low-power mode off: armrest shortcut keys, voice voice control function can also be used in standby state.

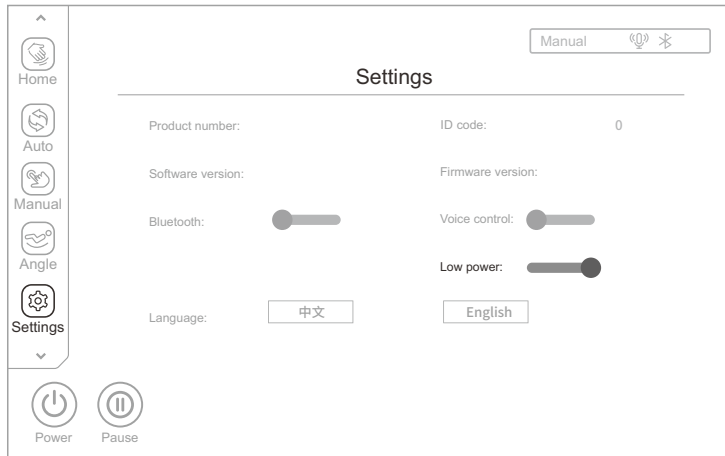

### 5. Language selection

The language is English by default. Chinese is optional.

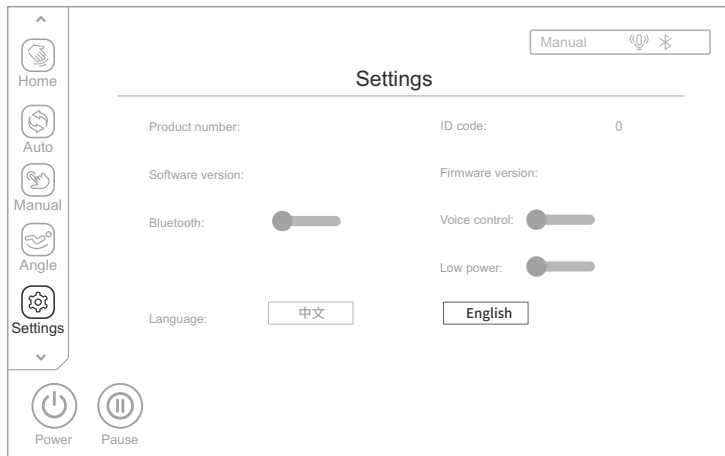

## Operation Instructions

### VII.Health detection (please use this function after the equipment is turned on)

#### 1.Health detect starts

Click the "Health" button in the menu bar on the left side of the display screen to enter the health detection interface, press the start detection button "Start" to perform health detection, and then gently place the index finger or middle finger on the sensor. After a few seconds, it will display the real-time data of heart rate, blood oxygen and microcirculation , waiting for the completion of the detection progress.

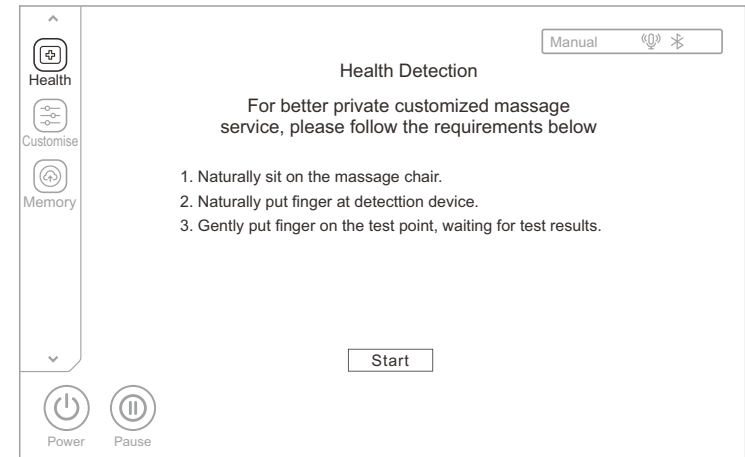

### Health check progress indicator

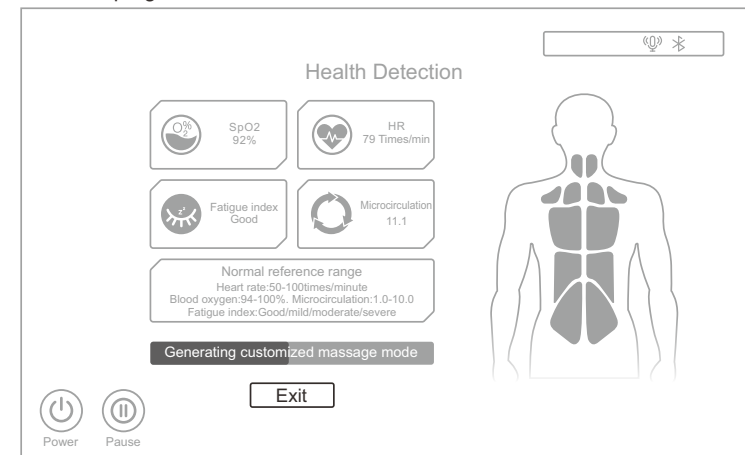

## Operation Instructions

### 2.Recommended program

When normal detection is completed, it will display the heart rate, blood oxygen, and the fatigue level, respectively. The blood oxygen means with the blood oxygen concentration ranging from 95% to 99% normally. The fatigue levels include Good, Mild, Moderate and Severe. Based on your fatigue level, an automatic program will be recommended for you. Select "Yes" to start using the recommended program and "No" to return to the message state before the health detection.

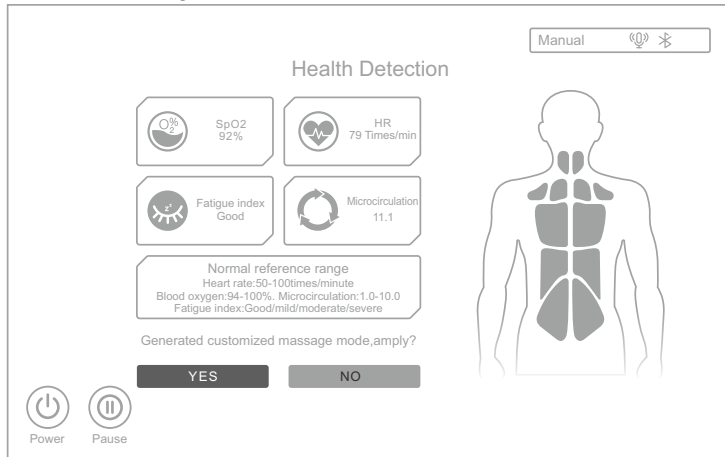

### 3.No valid data is detected.

If no valid data is detected, the user will be prompted to ask whether to re-detect. Select "Yes" to restart the health detection, and "No" to exit the detection and return to the message state before the health detection.



## Operation Instructions

### 4.Exit health detection.

During health detection, press the **Exit** key to exit the detection and return to the message state before the health detection.

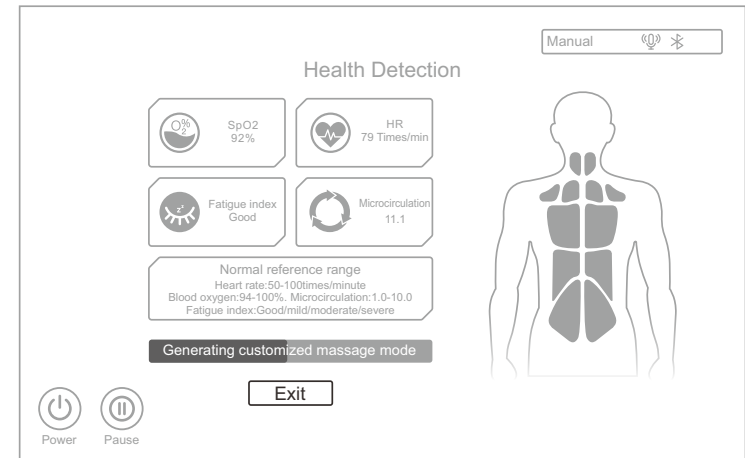

### VIII.Custom (please use this function after the equipment is turned on)

Click the "Custom" key in the menu bar on the left side of the display to enter the custom setting interface and select either Custom I or Custom II (only if the corresponding custom has been previously set and saved) for massage.

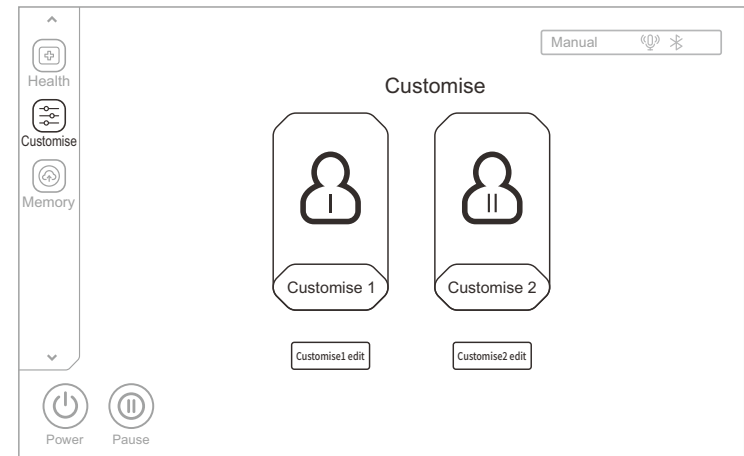

Schematic diagram of Custom



## Operation Instructions

Click Custom I Setting or Custom II Setting to enter the Custom Setting interface, then select the preferred massage technique whose icon will be highlighted after selection, and select the message interval, 4D intensity, air message, message width, message speed, air intensity, back heating, calf kneading and other functions, then click Save to save the current settings as Custom I and Custom II. After the settings are saved successfully, the custom program will be immediately available and can be used for the next massage by clicking the saved custom program.

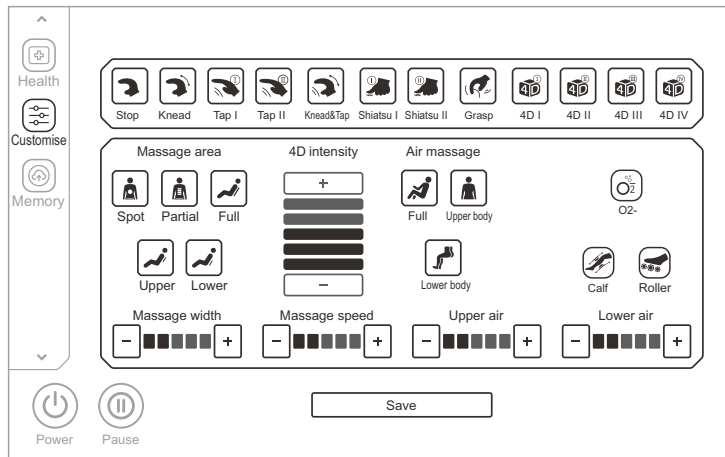

### IX. Storage (please use this function after the equipment is turned on)

Click the "Memory" icon in the menu bar on the left side of the display to enter the message function storage selection interface, with two categories including message function storage and message function call. Message storage includes: Storage I, Storage II and Storage III. Message call includes: Call I, Call II and Call III.

Key	Description
	Storage: Saving the currently running massage program, including automatic program, massage technique, air mode and intensity, position and angle of leg unit and backrest unit, and other massage functions.
	Call: Calling the previously saved massage program, including automatic program, massage technique, air mode and intensity, position and angle of leg unit and backrest unit, and other massage functions.

## Operation Instructions

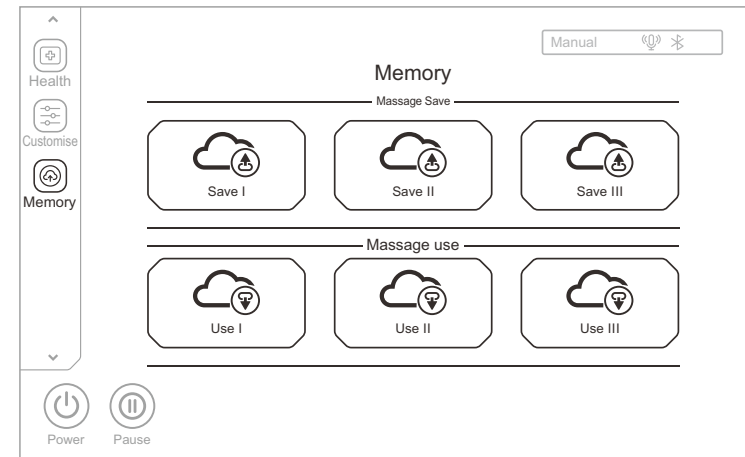

### X. Other functions (please use this function after the chair is turned on)

In the "Home" interface, select the "Belt heat" key to turn on or off the shawl heating function (for graphene heating). There will be warmth after turning on the heating function for 3 minutes.

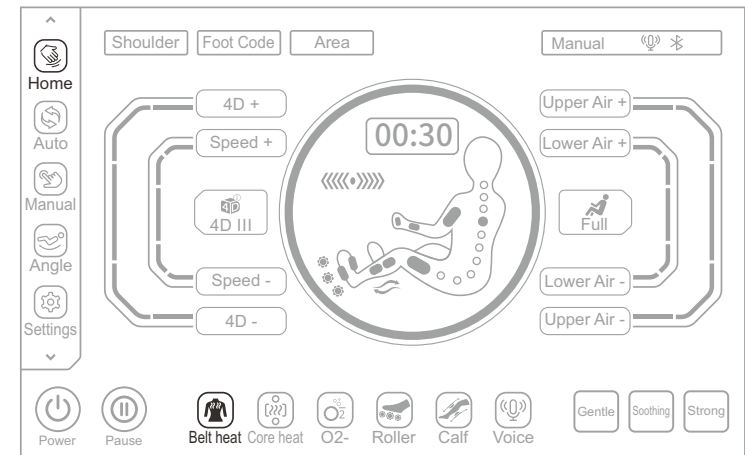

## Operation Instructions

In the "Home" interface, select the "Core heat" key to turn on or off Mechanical core heating function (jade heating). There will be warmth after turning on the heating function for 3 minutes.

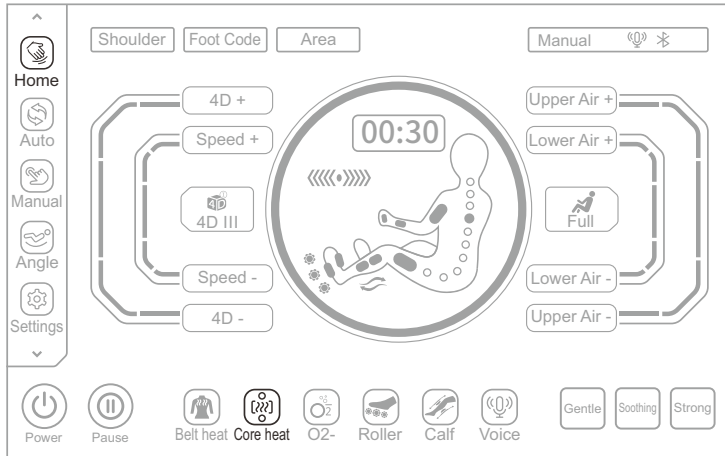



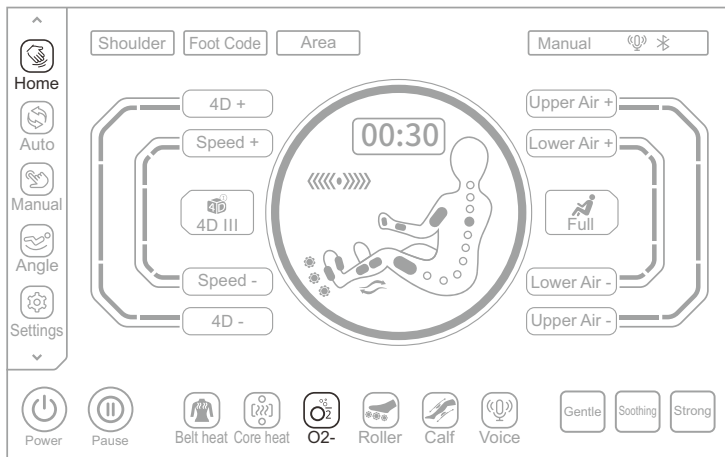

In the "Home" interface, select the "O2-Ion" button to turn on or off the O2-Ion function.

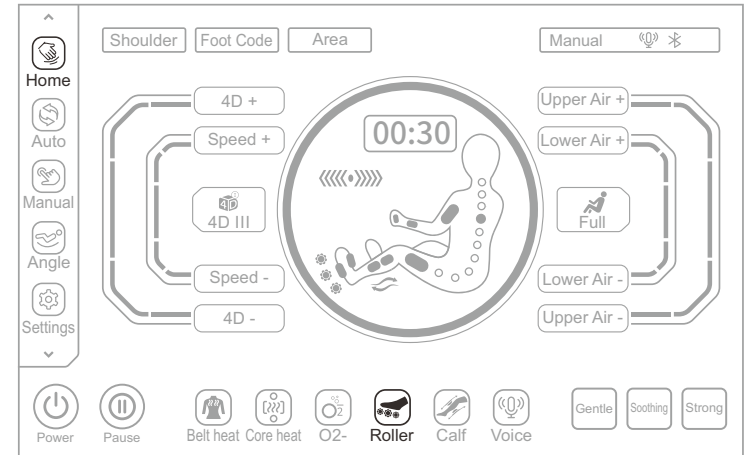

## Operation Instructions

In the "Home" interface, click the "Roller" button to turn on or off the foot roller massage function, with three adjustable speeds.



Key	Description
   Level 1 Level 2 Level 3	Press this key to enable or disable the Sole Roller function. Press it for the first time to start Level 1 speed; press it for the second time to start the Level 2 speed; press it for the third time to start the Level 3 speed; and press it for the fourth time to disable the Sole Roller function, which are switched cyclically.

## Operation Instructions

In the "Home" interface, select the "Calf" button to turn on or off the calf rubbing massage function; in The inner side of the calf is provided with rubbing massage function, and the outer side is provided with airbag squeeze massage function, which can relieve the calf muscle stiffness or tension caused by long standing.

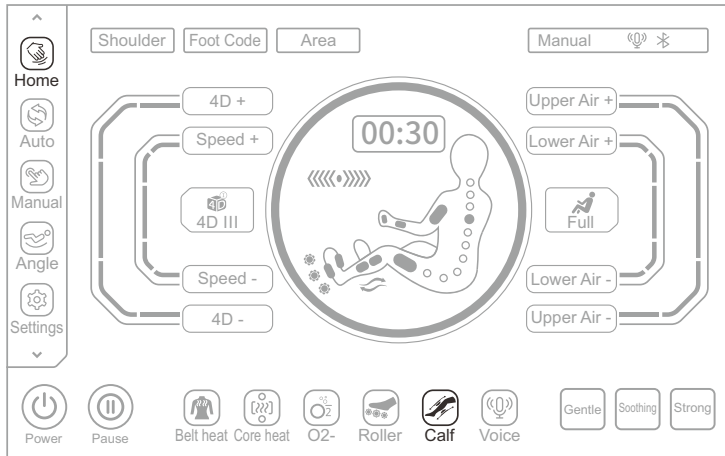

In the "Home" interface, select the "Voice" key to wake up the voice assistant.

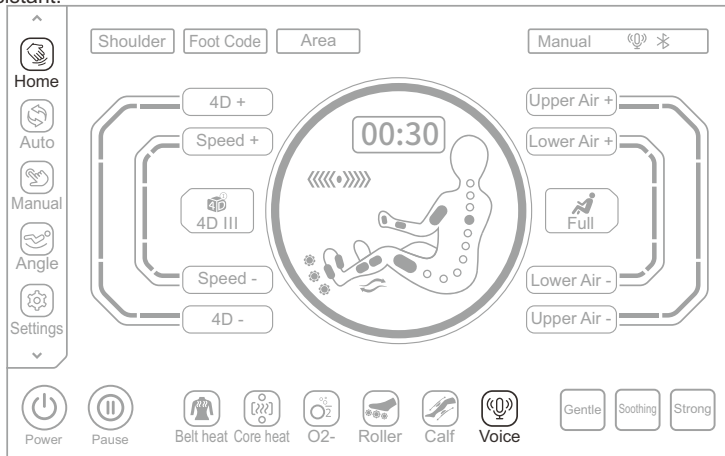

## Operation Instructions

In the "Home" interface, select the "Shoulder Position Adjustment" button, and press the up and down arrow buttons in the pop-up menu to adjust the shoulder position, with a total of 11 adjustable levels.

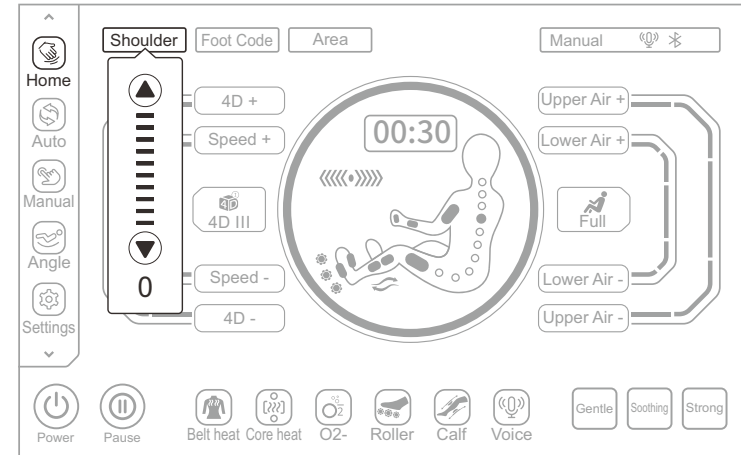

In the "Home" interface, press the "foot size selection" button to select the corresponding foot size for massage.

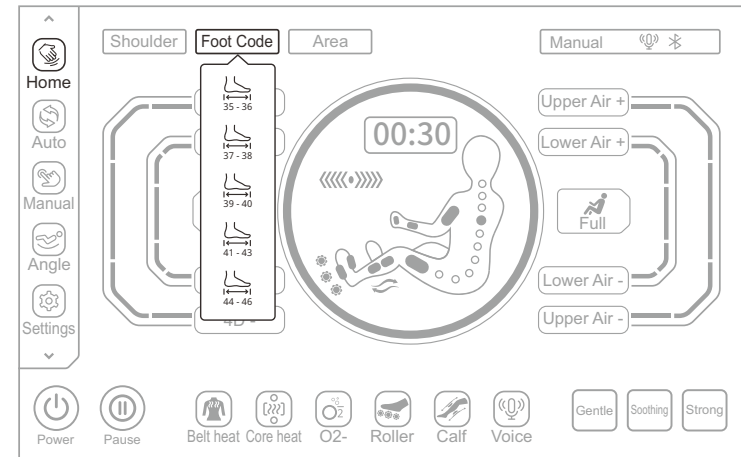

## Operation Instructions

In the "Home" interface, select the "massage time adjustment 00:30" button, press the plus and minus arrow head button in the pop-up menu, you can increase or decrease the massage time. Click the "+" key, the time increased by 5 minutes, the maximum increase to 40 minutes. Click the "-" key, the time decreased by 5 minutes.

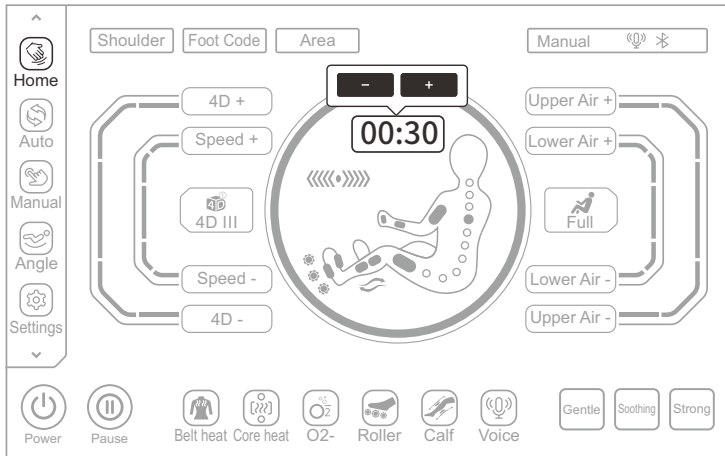

In the "Home" interface, select the "Gentle", "Soothing", "Strong" button to select the appropriate massage intensity.

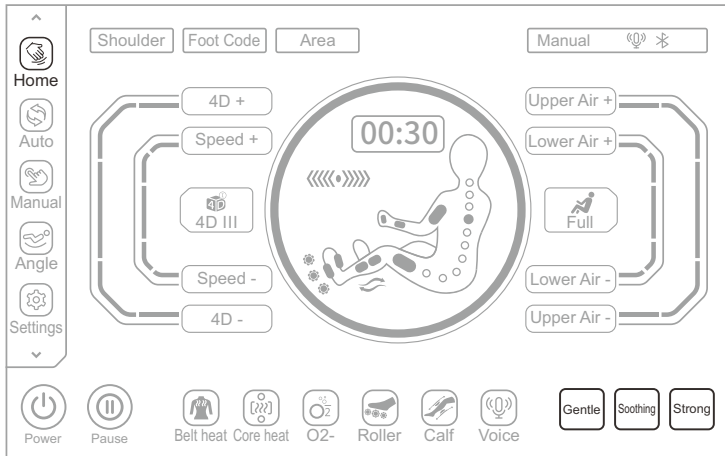

## Operation Instructions

### XI.End message

During massage, press the remote controller touch switch key or press the right armrest switch key to turn the equipment off. Immediately turn off all massage functions, reset the backrest unit and the leg unit, or when the massage timing time arrives, all massage functions will be automatically turned off, with the backrest unit and the leg unit not reset..

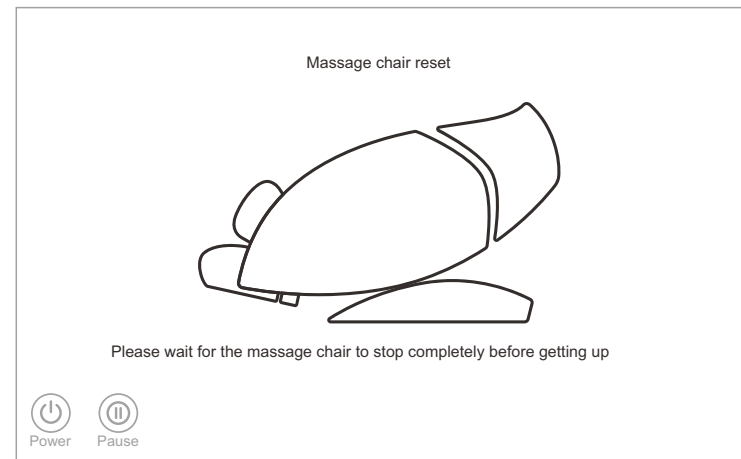

Cut off the whole machine power supply, as shown in the figure (Schematic diagram of power switch position of the whole machine).

Turn off the power switch ("0" position)

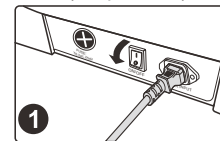

Schematic diagram of pulling out the power plug

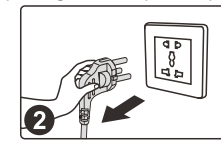

Remove the product connection power cord

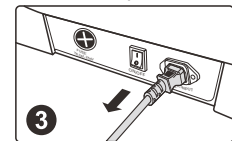

## Cleaning and Maintenance

### Cleaning synthetic leather and plastic parts

Wipe the leather with a soft, dry cloth.

- Do not use chemicals such as thinner, gasoline, alcohol, etc. to clean the unit.
- When using commercially available leather care products (rags), please follow the instructions for use.
- If synthetic leather is particularly dirty, wipe it in the following way.
  - ① Immerse a soft cloth in water or hot water containing 3% to 5% neutral detergent, then wring it out thoroughly.
  - ② Use the above soft cloth to wipe the leather surface.
  - ③ Wipe off the cleaning solution with a cloth soaked in clean water and thoroughly wrung out.
  - ④ Wipe with a wrung soft cloth.
  - ⑤ Let it air dry naturally.
- When it is difficult to remove stains, please immerse commercially available melamine foam in neutral detergent, and then wipe the machine with it.
- Do not use a hair dryer to dry the surface.
- Be careful when wiping the machine with denim and colored fabrics, as the color of the fabric will stain the surface of the synthetic leather.
- Do not keep these parts in contact with plastic for a long time, as this will cause discoloration.
- Synthetic leather may be discolored, so when using hair dye, please cover the touched part with a towel.

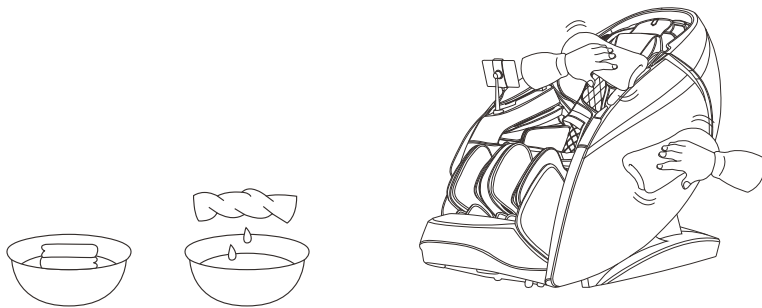

## Troubleshooting

<b>Fault</b>	When the calf mechanism or the backrest reaches a certain position, press the corresponding adjustment button and it will no longer change, and a continuous "beep, beep" sound will be emitted.
<b>Solution</b>	Due to product structure design and ergonomic requirements, this product has a limited protection design for the limit state of attitude adjustment. At the same time, a reminder sound will sound when the limit is reached.
<b>Fault</b>	The function does not work or some functions do not work after the machine is turned on.
<b>Solution</b>	After the machine is turned on by pressing the switch key, it is necessary to manually select an automatic massage program or other working state. If it is not operated, the machine will automatically shut down after 20 minutes. If the manual operation mode is selected, the functions that are not selected may be disabled, and the working mode needs to be manually set in the manual mode.
<b>Fault</b>	The machine makes a leather rubbing sound when adjusting its posture.
<b>Solution</b>	This product adopts high-grade anti-corrosion leather that meets environmental protection requirements. Due to the inherent characteristics of leather materials, there will be a normal slight noise when rubbing at the relative movement, which is a normal phenomenon. Note: If you hear fabric or leather tearing sound when the machine is running, please stop using it immediately and seek professional maintenance.
<b>Fault</b>	The massage wheel did not reach the shoulders or neck.
<b>Solution</b>	If the head does not touch the head cushion or the back does not touch the backrest, the shoulder position may be lower than the actual position during the body shape detection process. Sit in the deepest position of the seat, rest your head on the headrest, and start over from the beginning.
<b>Fault</b>	The unit is damaged. The power cord or power plug is abnormally hot.
<b>Solution</b>	To prevent accidents, be sure to contact an authorized service center.

Please feel free to contact the designated service personnel for any questions or doubts about this product.

## Product Specifications

---

Model: OS-Pro 4D DuoMax

Name: Massage Chair

Rated voltage: 110-120V~ 60Hz   
220-240V~ 50Hz/60Hz

Rated power: 220W

Rated time: 20min

Safety structure: Class I