

Osaki
JAPAN

Instruction Manual

JP-NEXUS 4D



Osaki

JAPAN

Before you start using your massage chair, please read this manual thoroughly for the correct methods of usage especially taking note of the section on safety.

This manual should be kept on hand for easy reference. It is your guide for safe and efficient operation. This product is designed for home use.

Contents



Important Safety Instructions	4
Product Parts	10
Before Use	14
Touch Screen Control Instructions and Definitions	22
Definition of the Function Icons	23
Definition of Quick Control	25
Definition of Side Panel Control	26
Operation Guide	27
Programs Description	42
Voice Control	44
After Use	47
Cleaning & Maintenance	48
Questions & Answers	49
Troubleshooting	50
Specifications	52
FCC Radiation Exposure Statement	53
Industry Canada Notice	54

Important safety instructions

Must be followed



These safety instructions must be strictly followed in use to avoid personal injuries and property damage :

■ All the safety instructions are described in compliance with degrees of the injuries or damage as a result of wrong use.



 Warning	Actions leading to cause serious injuries or death
 Caution	Actions leading to cause minor injuries or property damage

■ Pay attention to the symbols before safety instructions (an example is given below).



 Actions that must be absolutely forbidden	 Actions that must be done
---	---

 Warning	
 Must be followed	<p>● IMPORTANT SAFETY INSTRUCTIONS When using an electrical appliance, basic precautions should always be followed, including the following: Read all instructions before using (this appliance).</p>
	<p>● DANGER-To reduce the risk of electric shock:</p> <ul style="list-style-type: none"> • Always unplug this appliance from the electrical outlet immediately after using and before cleaning. • Never use pins or other metallic fasteners with this appliance. • Carefully examine the covering before each use. Discard the appliance if the covering shows any sign of deterioration, such as checking, blistering or cracking. • Keep Dry-Do not operate in a wet or moist condition.
	<p>● WARNING-To reduce the risks of burns, fire, electric shock or injury to persons:</p> <ul style="list-style-type: none"> • An appliance should never be left unattended when plugged in. Unplug from outlet when not in use and before putting on or taking off parts. • Close supervision is necessary when this appliance is used by, on, or near children, invalids, or disabled persons. • Use this appliance only for its intended use as described in this manual. Do not use attachments not recommended by the manufacturer. • Never operate this appliance if it has a damaged cord or plug, if it is not working properly, if it has been dropped, damaged or dropped into water. Return the appliance to a service center for examination and repair. • Do not carry this appliance by supply cord or using cord as a handle. • Keep the cord away from heated surfaces. • Never operate the appliance with the air openings blocked. Keep the air openings free of lint, hair and the like. • Never drop or insert any object into any opening. • Do not use outdoors. • Do not operate where aerosol (spray) products are being used or where oxygen is being administered. • To disconnect, turn all controls to the off position then remove plug from outlet. • Keep children away from extended foot support. • Connect this appliance to a properly grounded outlet only. See Grounding Instructions. • Use heated surfaces carefully. May cause serious burns. Do not use over insensitive skin areas or in the presence of poor circulation. The unattended use of heat by children or incapacitated persons may be dangerous. • Do not operate under blanket or pillow. Excessive heating can occur and cause fire, electric shock or injury to persons. <p>SAVE THESE INSTRUCTIONS</p>
<p>● Persons with the following conditions or under these medical treatments, should consult a physician before using this appliance.</p>	



Warning

 Must be followed	<p>(1) Persons with a pacemaker cannot use this product. The chair may cause an electronic malfunction to the medical device;</p> <p>(2) Patients with malignant tumors;</p> <p>(3) Patients with heart disease;</p> <p>(4) Persons unable to feel or insensitive to heat on their skin such as a diabetic patient;</p> <p>(5) Pregnant women or ones that have just given birth;</p> <p>(6) Persons with poor blood circulation such as a diabetic patient;</p> <p>(7) Osteoporosis patients, spinal fracture patients or persons with acute painful disease or injuries such as joint sprains or muscle strains;</p> <p>(8) Persons with any injuries should not use this appliance;</p> <p>(9) Persons with higher or lower body temperature, fever, inflammation, cold symptoms, high blood pressure or any poor health conditions should consult a physician before using this product;</p> <p>(10) Avoid falling asleep in this chair;</p> <p>(11) Any one with spinal or nerve conditions;</p> <p>(12) Persons with protrusion of intervertebral disc;</p> <p>(13) Do not wear loose clothing or jewelry as it might get caught with massage mechanism;</p> <p>(14) Keep long hair away from moving massage mechanism while in use.</p> <p>Otherwise discomfort or even physical injuries may occur.</p>
	<ul style="list-style-type: none"> ● If you feel unwell while using or after using the chair, stop immediately and contact your physician. Do not use the chair again unless approved by your doctor.
	<ul style="list-style-type: none"> ● Before operating or adjusting the chair, be sure that there are no obstructions that can cause damage to your chair. No pets or persons, near, in front or under the chair to avoid serious injury.
	<ul style="list-style-type: none"> ● Before using the chair, lift up the backrest pad and check the middle cover area where the massage rollers travel up and down. Be sure the middle nylon cover is not unzipped and has no signs of damage or tear caused by the roller heads. Using the chair while the roller heads are exposed could cause physical injury and electrical shock.
	<ul style="list-style-type: none"> ● When using the chair for the first time, it is recommended that you select the "Demo" mode to get familiar with various massage features of the chair. ● Do not use the chair for more than 30 minutes each time. ● Do not massage a single part of your body for more than 5 minutes. <p>Failing to follow these instructions, discomfort or even physical injuries may occur.</p>
	<ul style="list-style-type: none"> ● After using the chair, it is recommended that the chair is unplugged from the power outlet to avoid any surges caused by outages. It is HIGHLY ADVISABLE TO ALWAYS USE A SURGE PROTECTOR. Keep children or minors from using the chair without supervision to avoid misuse that could result in serious injuries.
	<ul style="list-style-type: none"> ● Follow the local code and regulations about use of electrical products . ● Use a 110V-120V, 60Hz power supply. (Do not use the chair in a country this product is not designed for or connect it with a transformer.) It may lead to electrical shock, product failure or internal components overheating causing fire hazard.
	<ul style="list-style-type: none"> ● Make sure the power cable is firmly plugged into the outlet to avoid power surges, short and electrical shocks. Electrical shocks may cause internal component overheating causing fire hazard. ● Wipe and clean the power plug regularly with dry cloth to avoid dirt or moisture built up.
 Must be followed	<ul style="list-style-type: none"> ● In the case of any abnormality with functions of the chair, stop using the chair immediately and pull out the power plug to avoid smoke, fires and electric shocks. Abnormality and fault examples ● If the chair is plugged in and the power switch is in the "ON" position and if the chair is not responding. ● When the chair is turned off but still operating. ● If you detect any burning smell or abnormal sounds. ● If you detect any parts of the upholstery that seemed to have melted due to over heating. <p>→ In any of these listed issues have occurred STOP using the product and unplug from the power outlet. Have the product inspected by an authorized service center.</p>
 Forbidden	<ul style="list-style-type: none"> ● Do not put any cushions or obstructions between the backrest pad and the backrest. This may damage the mechanism and result in personal injury. ● When moving or handling the chair, be sure to hold onto the recommended supported area. Otherwise parts of the chair may break resulting in serious injury.





Warning

 Forbidden	<ul style="list-style-type: none"> ● People with the following health issues should NOT use this chair: Persons for whom massage is not advisable by doctors. Such as persons with thrombosis, serious aneurysm, acute venous aneurysm, various skin inflammations (such as subcutaneous tissue inflammation) or various skin infections. Otherwise it may aggravate or cause serious injury.
	<ul style="list-style-type: none"> ● Anyone with physical injuries or poor health should NOT use this product. Persons with acute lumbago, protrusion of intervertebral disc or displacement of a lumbar vertebra. Otherwise it may aggravate or cause serious injury.
	<ul style="list-style-type: none"> ● Do not put hands, arms or feet into the traveling massage mechanism while the chair is operating. ● Keep small children away from the chair. Climbing could result in falls that could lead to serious injuries. ● Do not climb onto the backrest or the armrests. ● Do not apply excessive pressure leaning back on the backrest. ● Keep your head away from reachable areas of the backrest and the back cover. ● Young persons or persons with physical disabilities that can not operate the chair on their own, should not use this product or without supervision. Anyone with weakened physical conditions should consult a doctor before using the chair. ● When massaging the neck area, pay attention to the intensity of the massage and make sure it does not hurt the neck muscles or nerves.
	<ul style="list-style-type: none"> ● Do not damage the power cord. Do not damage, alter, bend, twist or use it with any extension cords. Do not place the power cord close to a heater. A damaged power cord may result in electric shocks, short circuit or fires. Please consult with the retailer/dealer from which you bought the product or a designated authorized service center about maintaining your power cord.
	<ul style="list-style-type: none"> ● When engaging the heat function of massage wheels, avoid prolonged contact with the skin in one position. Otherwise low-heat burns may occur. Even if the temperature is relatively lower at 40°C~60°C, low-heat burns may happen in spite of no obvious hot or painful sensation.
 Wet-hand operation forbidden	<ul style="list-style-type: none"> ● Do not insert or pull out the power plug when your hands are wet. Otherwise electric shocks may happen.
 Disassembly forbidden	<ul style="list-style-type: none"> ● Do not refit, disassemble or repair the product without the help of an authorized service provider. Otherwise fires, abnormal movements or personal injuries may happen.

Caution

 <p>Must be followed</p>	<ul style="list-style-type: none">● The following persons (even if they are physically healthy at present) should consult a physician before using the product.<ul style="list-style-type: none">(1) Persons with muscular atrophy due to old age or below normal weight;(2) Persons feeling lumbago with pain in the muscles and joints of the lower back;(3) Persons suffer from sprains or bruising easily;(4) Persons with motion sickness;(5) Persons who received a heart operation or another vascular operation.It may cause serious injury if not addressed properly. Otherwise it may aggravate or cause serious injury.● Before sitting on the product, make sure there is no foreign objects between any two parts of the chair. (Make sure there are no foreign objects on the back cover, the backrest, the seat surface, the lower leg/foot massage section or inside surface of the back cushion.) Otherwise accidents, injuries or product faults caused by clamping of hands, feet or other articles may occur. Before sitting on the seat, make sure the massage wheels are in the retracted positions.● Turn off the massage function before you get off the chair.● When the lower leg/foot massage section is not retracting after the massage, retract the footrest with the remote button.● When unplugging the chair, always hold onto the plug and not the cord to avoid damaging the power cord. Damaged cord could result in shock and serious injuries.● Before moving the chair, be sure the backrest is up and the footrest is retracted in default positions. Otherwise injuries may happen.● When moving the product by dolly, lay mats on the floor to avoid markings or damage to the floor. Do not roll the chair on engineered wood or soft wood floorings. Otherwise marks and damage may occur.● Keep the safety lock key. Keep children away the remote control.● Before moving the chair, make sure there are no obstructions around. If lifting is required, make sure to lift from the steel frame of the chair. Be sure to maintain good balance or the heavy chair could tip and fall on the movers, causing serious injuries.● Symptoms such as skin inflammation, itching or swelling when using the chair, stop the using the product immediately and consult a physician.
 <p>Forbidden</p>	<ul style="list-style-type: none">● Do not use the product with other electrical devices at the same time, such as heating blanket.● Do not place your hands, arms, feet or any parts of your body to massage area that are not designed for the body parts to avoid discomfort or injuries.● Do not put the knees between the calf massager. This may cause serious injury.● Do not fall asleep while using the product.● Do not use the product after drinking alcohol.● If the airbag on the seat is not completely deflated, do not stand or jump on the seat or put things on it. It could risk puncture.

Caution

 Forbidden	<ul style="list-style-type: none"> ● Do not put hands or feet between footrest and seat base. ● Do not put hands or feet between footrest and side panel. ● Do not put hands or feet between seat base and side panel. ● Do not put hands or feet between the upper and the lower part of the footrest. ● Do not put hands or feet in the gap of seat base. ● Do not put pets on the massage chair. ● Do not pull out the power plug or turn off the power switch suddenly during massage operation.
	<ul style="list-style-type: none"> ● Do not stand or sit on the back cover. The chair may topple.
	<ul style="list-style-type: none"> ● Do not stand or sit on the armrests.
	<ul style="list-style-type: none"> ● Do not stand or sit on the lower leg/foot massage section or the footrest.
	<ul style="list-style-type: none"> ● Do not drag or push the product after it is installed.
	<ul style="list-style-type: none"> ● Do not move the product while there is a person sitting on it.
	<ul style="list-style-type: none"> ● Do not use the product with other heating devices such as electric blankets. Otherwise fires may occur due to overheating.
	<ul style="list-style-type: none"> ● Do not leave the remote controller on the seat, always return it to its holder.
<ul style="list-style-type: none"> ● If there is any foreign objects between the backrest and the backrest pad, stop using the chair and turn off. Remove the foreign object and make sure the chair is operating properly before using again. 	
 Wet-hand contact forbidden	<ul style="list-style-type: none"> ● Do not place this chair in locations with high humidity such as the bathroom. Moisture will destroy electrical components resulting in product failure or worst, electrical shock and other serious injuries.
 Product wetting forbidden	<ul style="list-style-type: none"> ● Do not use any liquid aerosol sprays around the chair. Otherwise electric shocks, short circuit or product failure may happen.
 Pull out the power plug	<ul style="list-style-type: none"> ● Before cleaning or maintaining the product, always unplug the power cord.
	<ul style="list-style-type: none"> ● In the case of a power failure, pull out the power plug at once. It is highly recommended to plug chair into a surge protector to protect the chair from shorting during outages.
	<ul style="list-style-type: none"> ● When the product is not in used, pull out the power plug.

GROUNDING INSTRUCTIONS

This product must be grounded. If it should malfunction or break down, grounding provides a path of least resistance for the electric current to reduce the risk of electric shock. This product is equipped with a cord with an equipment-grounding conductor and a grounding plug. The plug must be plugged into an appropriate outlet that is properly installed and grounded in accordance with all local codes and ordinances. **Danger-Improper connection of the equipment-grounding conductor can result in a risk of electric shock. Check with a qualified electrician or serviceman if you are in doubt as to whether the product is properly grounded. Do not modify the plug provided with the product – if it will not fit the outlet, have a proper outlet installed by a qualified electrician.**

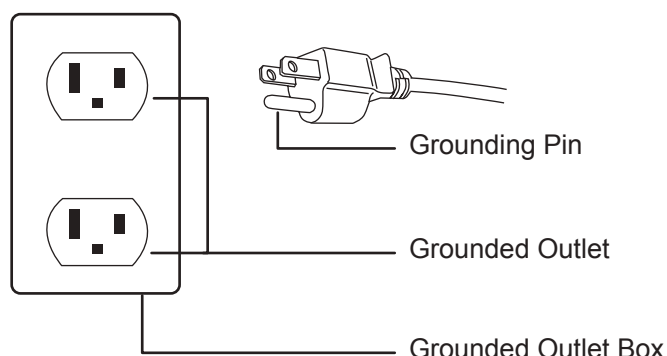

Product Parts

Chair Front



Chair Side



Chair Side



Airbag Position



Before use

1 Footrest Installation

- (1) Two box packaging of the chair, main chair unit and footrest.
Remove all the packaging, take out all of the parts.

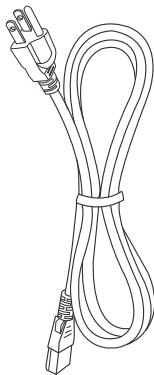

Power Line x1



Circlip x2

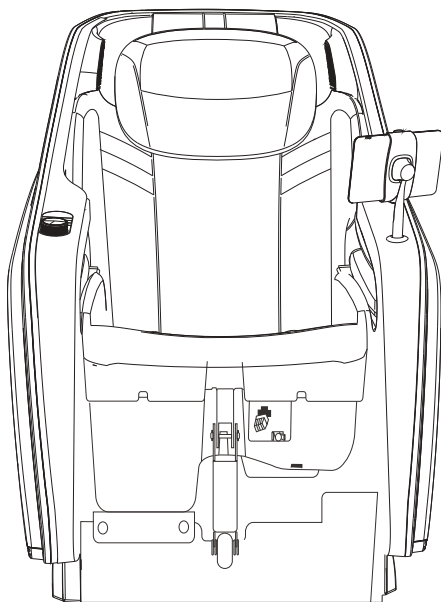

Main Chair Unit

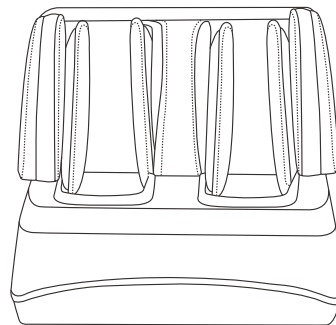

Footrest

Before use

(2) Install the footrest.

a) Connect the footrest data line (B1, B2) and air hose (A1, A2).

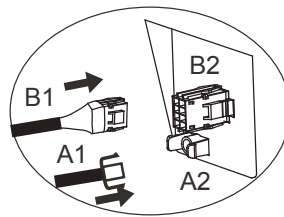
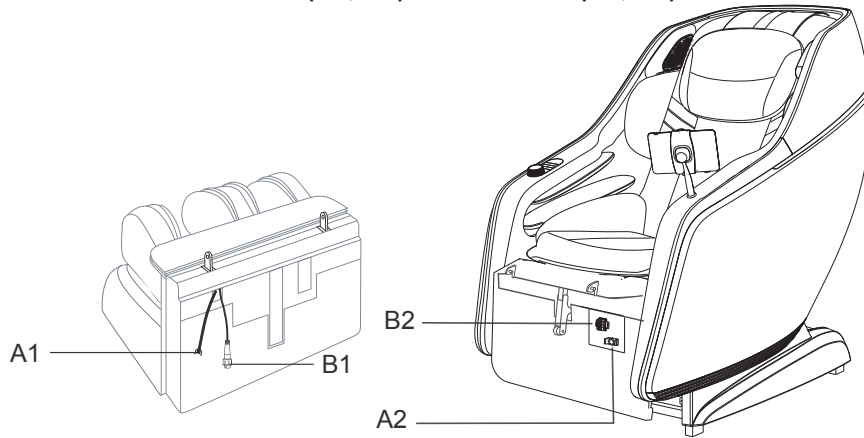

b) Line up the holes from the footrest (C1) to the base of the chair (C2) as shown below, then lock it in with the buckle (Figure 1).

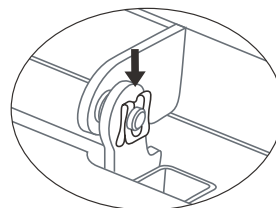
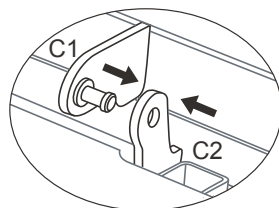
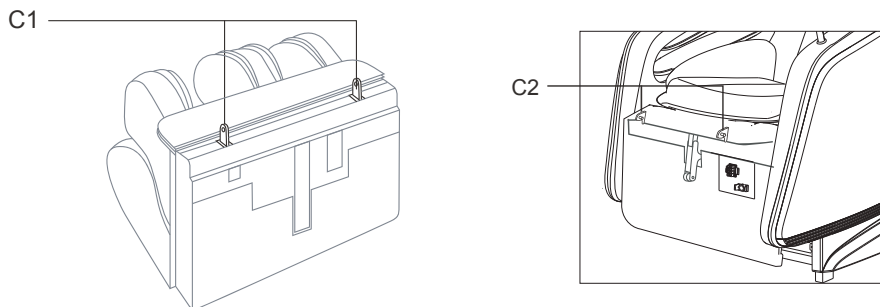
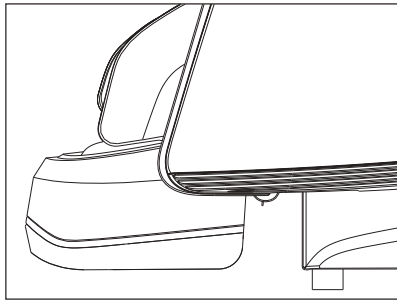
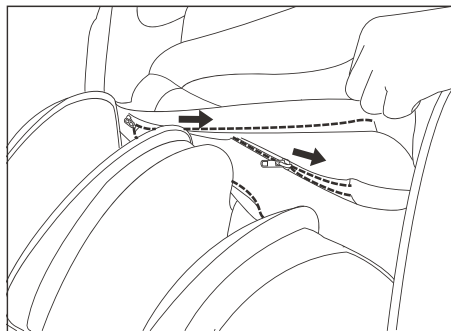

Figure 1

Before use



(3) Zip up seat cushion to the legrest as shown below. Then footrest installation is done.



NOTE:

If you have the installation problems, kindly contact with your local service department for help.

Before use

2 Place Position

- Before moving the chair, make sure it is powered off and nobody using it.
- As the chair is heavy, please exercise extra care not to abruptly drop it. This may cause damage to the floor as well as the internal components of the chair.
- Place the chair in desired flat location nearing to the power outlet. Make sure there is enough room for the chair to recline and for the user to get in and out of the chair freely.
- Make sure to use a mat or rug under the chair if you place the chair on top of hard ground.

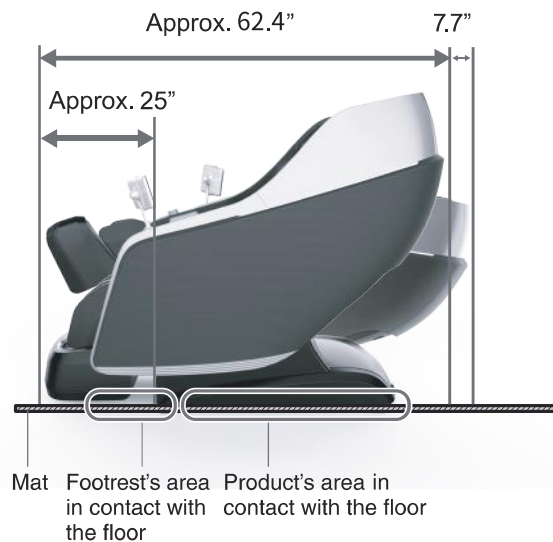

- Do not place the chair directly under the sunlight or near high-temperated areas. Otherwise the sunlight or hot temperature may cause fading, discoloration, or hardening of the upholstery.
- Do not place the chair in an excessively humid or dusty environment as this may result in malfunction or electric shock.
- Put a mat or rug under the chair to prevent scratching the floor and to reduce noise during operation. The dimension of the mat or rug is suggested to be 63.0" X 35.4".

- Suggested dimension of mat or rug

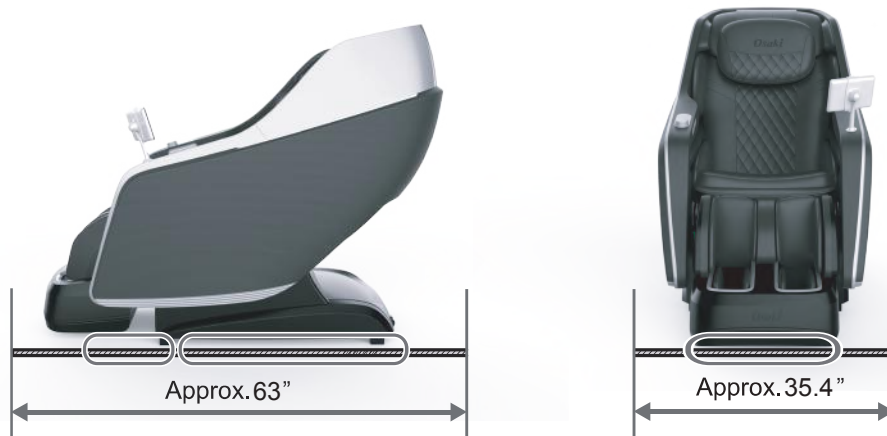

3 Check Carefully around the Chair

- Make sure there is no person, pet or other object close to the product.



- Make sure there is no foreign object in the chair as well as in the seams of the chair.

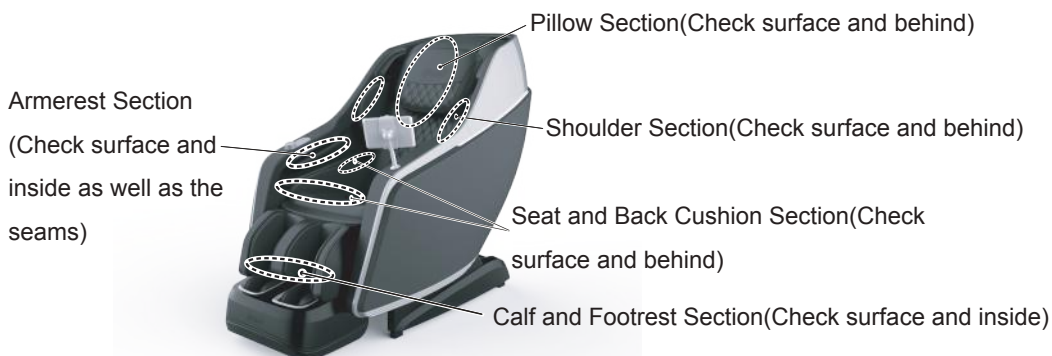

- Do not put hands or feet between footrest and seat base.
- Do not put hands or feet between footrest and side panel.
- Do not put hands or feet between seat base and side panel.
- Do not put hands or feet between calf and footrest.
- Do not put hands or feet in the gap of seat base.
Otherwise it may cause injuries.

4 Check Carefully Over the Power Cord and Power Plug

- Make sure the power cord and power plug are clean without any dust.
- Make sure the power cord and power plug are dry and not wet.
- Make sure the power cord and power plug are completely good without any visible damage.
- Wipe out the dust with dry cloth if needed.



- Do not use the cord and plug if being damp.
- Do not bend, twist, entangle or put heavy objects over the cord and plug or it may be damaged.
- Do not use the damaged cord or plug or it may cause electric shocks, short circuits, or fires.
- Keep the cord and plug away from fire sources, such as cigarettes and ashtrays and away from heated vents and heated motors and others that may have high temperature.
- If any problems of the cord and plug, consult with your local service center for help.



Insert the plug completely into the connector.

5 Power on the Chair

- 1 Insert the power plug completely into the power socket.
- 2 Turn the switch to the "I" (ON) position to activate the chair.

 WARNING	
<ul style="list-style-type: none">● Make sure the power cord is completely and firmly inserted into the power socket. Otherwise electric shocks or fires may happen.	
<ul style="list-style-type: none">● Follow the regulations on use of the socket and the wiring devices strictly.● Use a 110-120V~, 50/60Hz power supply.● Do not use the product in a foreign country or connect it with a transformer without permission. Otherwise electric shocks, product faults or fires may happen.	
<ul style="list-style-type: none">● Do not insert or pull out the power plug with wet hands. Otherwise an electric shock may happen.	

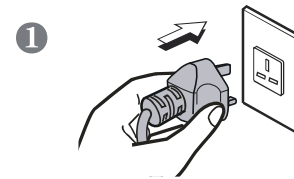

Before use (Continued)

6 Make Sure the Massage Rollers are Retracted



When the chair is off, the rollers are stored in the top of the backrest. This is known as the retracted position. If the rollers are not in the retracted position, simply reset by pressing the power button on the touch screen control before sitting on the chair.

7 Make Sure the Fabric is not Damaged nor Cracked

Check the synthetic leather of the backrest where the massaging rollers travel along. Be sure that there is no damage, cracked or any unusual or improper wear.

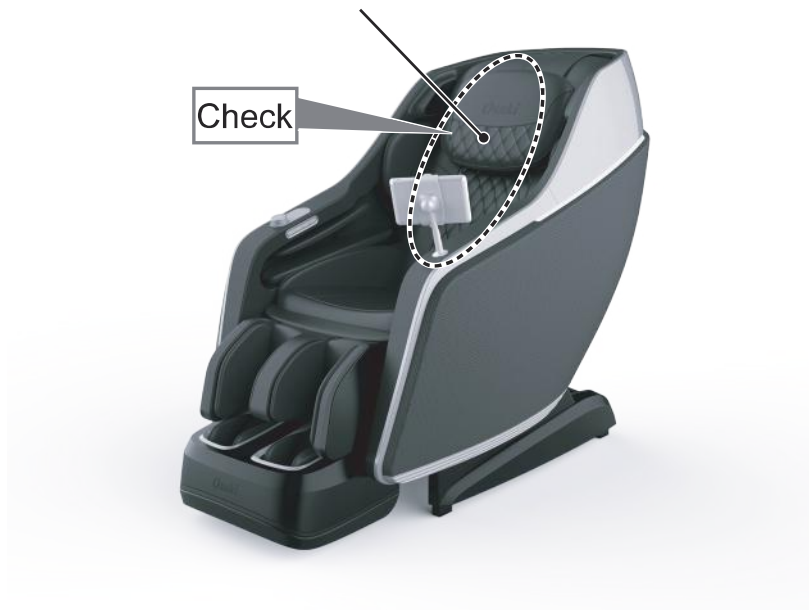

WARNING

- **Before use, raise up the back cushion and check whether fabric lining pointed out in the figure is not damaged.**
- **If the fabric is slightly damaged, please also stop using the chair immediately. Pull out the power plug and ask for your local service center for a new replacement.**

Otherwise, you may get injured or get an electric shock for the damaged fabric when using the chair.

Touch Screen Control Instructions and Definitions

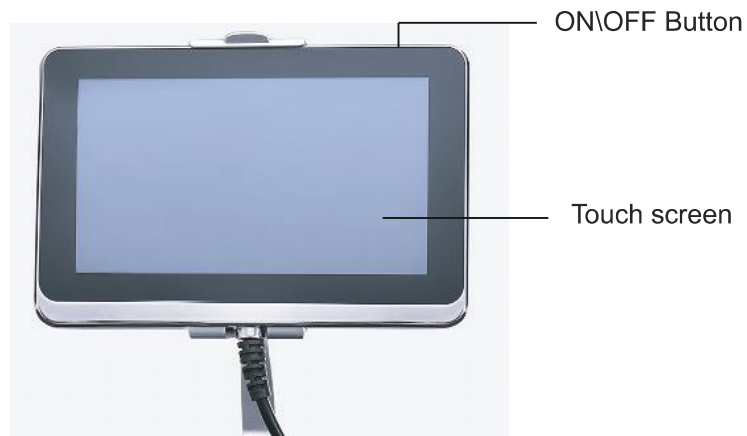

1 ON/OFF Button

- Before using, press this button for about 3 seconds to turn on the chair and start massage. Then touch any massage icon on the screen to start the program you choose.
- After using, press this button for about 3 seconds to turn off the chair and end massage. And chair will return to its original position state.









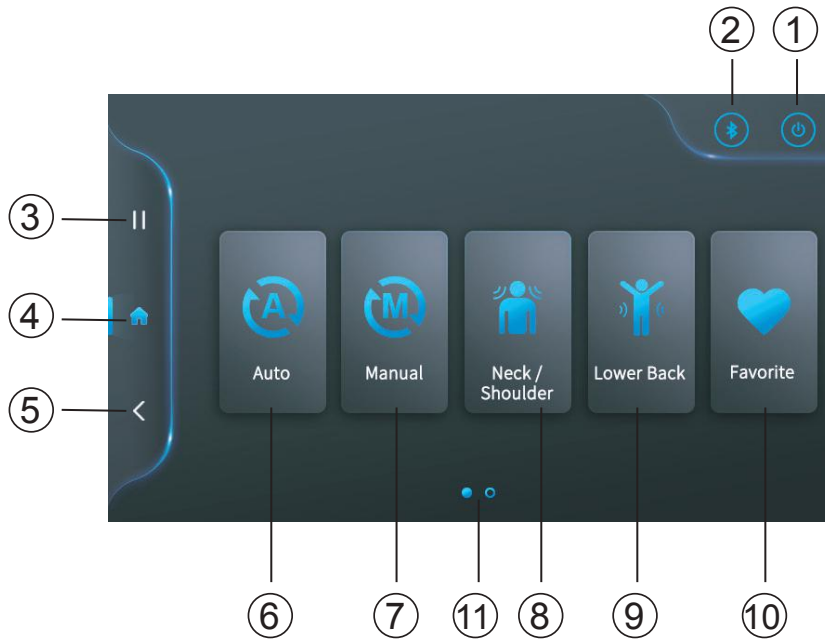

NOTE: Power switch is on the right top corner of the control.

2 Touch screen







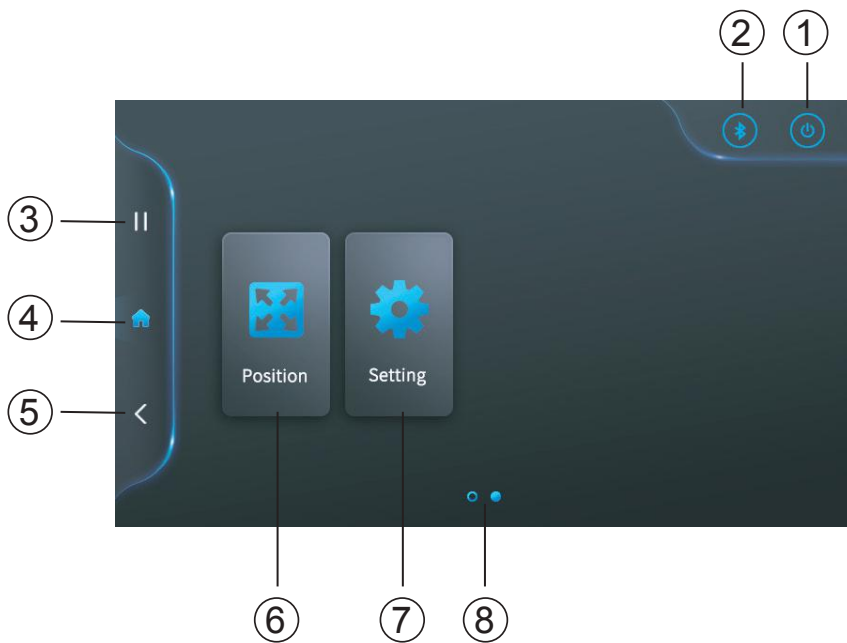

- There are 7 main function icons in the touch screen to select for operation.

Definition of the Function Icons















1.  : Power control icon
2.  : Bluetooth icon
3.  : Pause message icon
4.  : Home page
5.  : Go back to previous page icon
6.  : 8 auto programs to select
7.  : Manual message modes to select
8.  : 4 auto programs for caring neck and shoulder
9.  : 4 auto programs for caring lower back
10.  : Favorite auto programs to keep
11.  : Two pages to slide over



1.  : Power control icon
2.  : Bluetooth icon
3.  : Pause massage icon
4.  : Home Page
5.  : Go back to previous page icon
6.  : Position icon for adjusting the chair
7.  : Settings of the chair
8.  : Two pages to slide over

Definition of Quick Control



-  **Power on/off**
-  **Icon with no function**
-  **Air Massage icon**
-  **Increase the air intensity**
-  **Decrease the air intensity**
-  **Footrest icon**
-  **Raise the footrest**
-  **Down the footrest**
-  **Backrest icon**
-  **Raise the backrest**
-  **Down the backrest**
-  **Full Body Icon**
-  **Raise the chair**
-  **Down the chair**

Definition of Side Panel Control



- Bluetooth** Bluetooth function control button
- Heating** Heating function control button
- ZGR** Zero gravity control button
- Auto** Auto massage programs control button.
Press once for each time, chair will give you different auto
massage programs.

Operation Guide

1. Power on

- There are 3 ways of turning on the chair.

(1) Turn on the chair by pressing the switch button for about 3 seconds on the top of the touch screen control.



(2) Turn on the chair by pressing the power button for about 3 seconds on the dial.

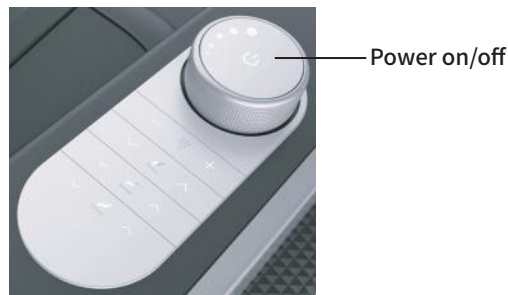

(3) This chair has voice control function. You can wake it up by speaking “Hey Osaki”. Then chair will respond to you as “How can I assist?”. You can next speak “Turn on” or “Power on”. After chair responds to you as “Okay”, it will turn on.

- When chair is on, you will see the first page showing the below logo as “Osaki”.



2. Auto

- Touch [Auto] , enter to the auto programs page.
- There are 8 auto massage programs - Sport, Relax, Sweet Dream, Thai Stretch, Blood Circulation, Focus, Yoga and Demo. Select one of them to start massage.
- When choose one auto program, chair will automatically take body scanning for you.
- After scanning, you will enter to a page showing if the position of the rollers on your shoulder is suitable or not. You can adjust the position by clicking ^ v and save it by ✓ .
- After you confirm your shoulder position, it will enter to the auto program page that you choose.
- For 4D intensity, you can click "+ -" to adjust. There are 6 intensity adjustments of the rollers.
- For air intensity, you can click "+ - " of "Intensity" to adjust. There are 5 adjustments of air intensity. The maximum adjustment is 5 while the minimum is 1.
- For LED, click it once, it will enter to LED page in which you can choose light for One Color or Breathing. Five light colors to choose, White, Orange, Cyan, Blue and Purple. Just choose one you like. Or you can click Breathing icon that lights will show with mixed colors. Also, if you click Rhythm, lights will jump up with the rhythm.
- For Calf Kneading, touch the icon once to turn on the calf kneading function while touch it again to turn it off.
- For Foot Kneading, touch the icon once to turn on the foot kneading function while touch it again to turn it off.
- For Back Roller Heating, touch the icon once to turn on the heating while touch it again to turn it off. When you turn it on, you cannot click Waist Heating unless you turn off Back Roller Heating.
- For Waist Heating, touch the icon once to turn on the heating while touch it again to turn it off. When you turn it on, you cannot click Back Roller Heating unless you turn off Waist Heating.
- If you like the auto program that you choose, you can click " ♥ " icon and light it up on top of the screen to mark it as your favorite program. And the auto program you selected will be in your favorite list and easy for you to click for massage next time. If you click " ♥ " icon again, it will not be in your favorite list.

NOTE:



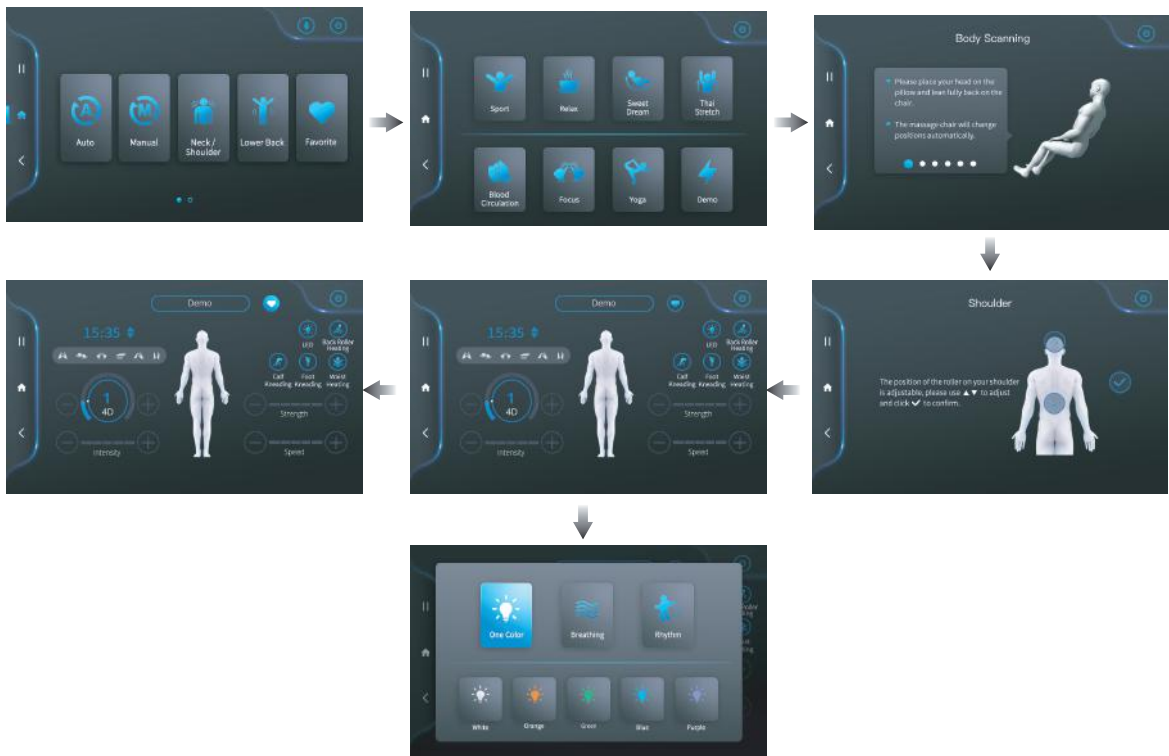





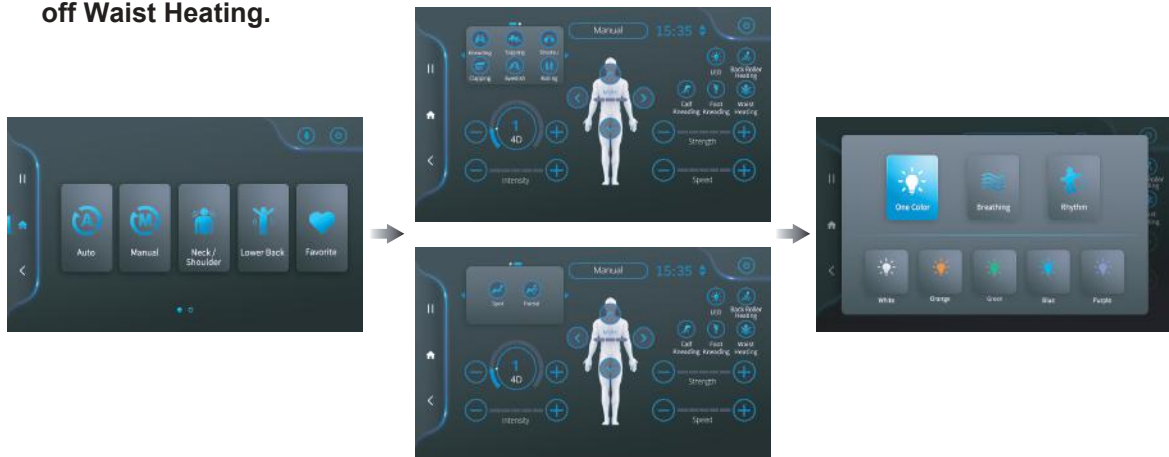

















































- If [Auto] is your first choice when you turn on the chair, you click any one of the auto programs, chair will automatically scan your body for just a time. You can then enjoy other auto programs, Neck/Shoulder programs and Lower Back programs without body scanning for a second time.
- Strength and Speed are set for default.



3. Manual

- Touch [Manual] , enter to the manual programs page.
- There are 6 manual massage modes you can see in the page - Kneading, Tapping, Shiatsu, Clapping, Swedish and Rolling. You can choose just one single mode or you can choose the combined modes to enjoy massage. There are total of 35 manual massage techniques for selection. Please refer to the detailed explanations afterwards.
- For Spot icon, it allows user to select spot for any part on the back. Touch once to activate spot massage at your desired position while touch again to stop the function.
- For Partial icon, it allows user to select 1/4 of the back part. Touch once to activate partial massage while touch again to stop the function.
- For 4D intensity, you can click “+ -” to adjust. There are 6 intensity adjustments of the rollers.
- For Intensity/Strength/Speed, there are 5 different levels of adjustment.
- For ^ v icons, when pressing Spot button, it will freeze the massage rollers from moving up or moving down, concentrating the massage at that part. Adjust the part position you want by these two icons.
- For Width, it refers to roller width. It can be only adjusted for Tapping, Shiatsu and Rolling by pressing left and right arrow icons.
- For LED, click it once, it will enter to LED page in which you can choose light for One Color or Breathing. Five light colors to choose, White, Orange, Cyan, Blue and Purple. Just choose one you like. Or you can click Breathing icon that lights will show with mixed colors. Also, if you click Rhythm, lights will jump up with the rhythm.
- For Calf Kneading, touch the icon once to turn on the calf kneading function while touch it again to turn it off.
- For Foot Kneading, touch the icon once to turn on the foot kneading function while touch it again to turn it off.
- For Back Roller Heating, touch the icon once to turn on the heating while touch it again to turn it off. When you turn it on, you cannot click Waist Heating unless you turn off Back Roller Heating.
- For Waist Heating, touch the icon once to turn on the heating while touch it again to turn it off. When you turn it on, you cannot click Back Roller Heating unless you turn off Waist Heating.



35 Manual Massage Techniques		Operation Way
Single Technique	Kneading 1	Click  once
	Kneading 2	Click  twice
	Tapping 1	Click  once
	Tapping 2	Click  twice
	Shiatsu 1	Click  once
	Shiatsu 2	Click  twice
	Clapping 1	Click  once
	Clapping 2	Click  twice
	Swedish 1	Click  once
	Swedish 2	Click  twice
	Rolling	Click  once
Combinated Techniques	Kneading 1 & Tapping 1	Click  once and click  once
	Kneading 1 & Tapping 2	Click  once and click  twice
	Kneading 2 & Tapping 1	Click  twice and click  once
	Kneading 2 & Tapping 2	Click  twice and click  twice
	Kneading 1 & Shiatsu 1	Click  once and click  once
	Kneading 1 & Shiatsu 2	Click  once and click  twice
	Kneading 2 & Shiatsu 1	Click  twice and click  once
	Kneading 2 & Shiatsu 2	Click  twice and click  twice
	Kneading 1 & Clapping 1	Click  once and click  once
	Kneading 1 & Clapping 2	Click  once and click  twice
	Kneading 2 & Clapping 1	Click  twice and click  once
	Kneading 2 & Clapping 2	Click  twice and click  twice
	Tapping 1 & Swedish 1	Click  once and click  once
	Tapping 1 & Swedish 2	Click  once and click  twice
	Tapping 2 & Swedish 1	Click  twice and click  once
	Tapping 2 & Swedish 2	Click  twice and click  twice
	Swedish 1 & Clapping 1	Click  once and click  once
	Swedish 1 & Clapping 2	Click  once and click  twice
	Swedish 2 & Clapping 1	Click  twice and click  once
	Swedish 2 & Clapping 2	Click  twice and click  twice
	Shiatsu 1 & Swedish 1	Click  once and click  once
	Shiatsu 1 & Swedish 2	Click  once and click  twice
	Shiatsu 2 & Swedish 1	Click  twice and click  once
Shiatsu 2 & Swedish 2	Click  twice and click  twice	

NOTE:

(1) Kneading: can adjust 4D(Roller intensity) and Strength while Intensity(Air intensity) and Speed are set to default.

(2) Tapping/Shiatsu/Clapping: can adjust 4D(Roller intensity) and Speed while Intensity (Air intensity) and Strength are set to default.

(3) Kneading & Tapping/ Kneading & Shiatsu/ Kneading & Clapping/ Tapping & Swedish: can adjust 4D(Roller intensity), Strength and Speed while Intensity(Air intensity) is set to default.

(4) Swedish & Shiatsu: can adjust 4D(Roller intensity) and Speed while Strength and Intensity(Air intensity) are set to default.

(5) Swedish/Rolling: can only adjust 4D(Roller intensity) while Intensity(Air intensity)/ Strength/ Speed are set to default.

(6) Spot and Partial are both applicable for all the manual massage modes except for Rolling. Rolling can only choose Partial instead of Spot.

4. Neck/Shoulder

- Touch [Neck/Shoulder] , enter to the Neck/Shoulder massage page.
- There are 4 auto programs for Neck/Shoulder - Calm, Recover, Care and Shiatsu. Select one of them to start massage.
- When choose one auto program, chair will automatically take body scanning for you.
- After scanning, you will enter to a page showing if the position of the rollers on your shoulder is suitable or not. You can adjust the position by clicking ^ v and save it by ✓.
- After you confirm your shoulder position, it will enter to the auto program page that you choose.
- For 4D intensity, you can click “+ -” to adjust. There are 6 intensity adjustments of the rollers.
- For Intensity/Strength/Speed, there are 5 different levels of adjustment.
- For LED, click it once, it will enter to LED page in which you can choose light for One Color or Breathing. Five light colors to choose, White, Orange, Cyan, Blue and Purple. Just choose one you like. Or you can click Breathing icon that lights will show with mixed colors. Also, if you click Rhythm, lights will jump up with the rhythm.
- For Calf Kneading, touch the icon once to turn on the calf kneading function while touch it again to turn it off.
- For Foot Kneading, touch the icon once to turn on the foot kneading function while touch it again to turn it off.
- For Back Roller Heating, touch the icon once to turn on the heating while touch it again to turn it off. When you turn it on, you cannot click Waist Heating unless you turn off Back Roller Heating.
- For Waist Heating, touch the icon once to turn on the heating while touch it again to turn it off. When you turn it on, you cannot click Back Roller Heating unless you turn off Waist Heating.
- If you like the auto program that you choose, you can click “ ❤ ” icon and light it up on top of the screen to mark it as your favorite program. And the auto program you selected will be in your favorite list and easy for you to click for massage next time. If you click “ ❤ ” icon again, it will not be in your favorite list.

NOTE:

- If [Neck/Shoulder] is your first choice when you turn on the chair, you click any one of the neck/shoulder programs, chair will automatically scan your body for just a time. You can then enjoy other Neck/Shoulder programs, Auto programs and Lower Back programs without body scanning for a second time.
- Strength and Speed are set for default.



5. Lower Back

- Touch [Lower Back] , enter to the Lower Back massage page.
- There are 4 auto programs for Lower Back - Joint Care, Recover, Deep Tissue and Lumbar Care. Select one of them to start massage.
- When choose one auto program, chair will automatically take body scanning for you.
- After scanning, you will enter to a page showing if the position of the rollers on your shoulder is suitable or not. You can adjust the position by clicking ^ v and save it by ✓ .
- After you confirm your shoulder position, it will enter to the auto program page that you choose.
- For 4D intensity, you can click “+ -” to adjust. There are 6 intensity adjustments of the rollers.
- For Intensity/Strength/Speed, there are 5 different levels of adjustment.
- For LED, click it once, it will enter to LED page in which you can choose light for One Color or Breathing. Five light colors to choose, White, Orange, Cyan, Blue and Purple. Just choose one you like. Or you can click Breathing icon that lights will show with mixed colors. Also, if you click Rhythm, lights will jump up with the rhythm.
- For Calf Kneading, touch the icon once to turn on the calf kneading function while touch it again to turn it off.
- For Foot Kneading, touch the icon once to turn on the foot kneading function while touch it again to turn it off.
- For Back Roller Heating, touch the icon once to turn on the heating while touch it again to turn it off. When you turn it on, you cannot click Waist Heating unless you turn off Back Roller Heating.
- For Waist Heating, touch the icon once to turn on the heating while touch it again to turn it off. When you turn it on, you cannot click Back Roller Heating unless you turn off Waist Heating.
- If you like the auto program that you choose, you can click “ ♥ ” icon and light it up on top of the screen to mark it as your favorite program. And the auto program you selected will be in your favorite list and easy for you to click for massage next time. If you click “ ♥ ” icon again, it will not be in your favorite list.

NOTE:

- If [Lower Back] is your first choice when you turn on the chair, you click any one of the Lower Back programs, chair will automatically scan your body for just a time. You can then enjoy other Lower Back programs, Auto programs and Neck/Shoulder programs without body scanning for a second time.
- Strength and Speed are set for default.



6. Favorite

- Touch [Favorite] , enter to the Favorite page.
- This page contains the favorite auto programs that you choose. You can keep 4 favorite auto programs a time. And they will show the auto massage name accordingly. It's very easy for you to select to start massage next time.
- And if nothing in the Favorite page, it will note you that “There are no favorite programs.”. Then you can leave for [Auto] , [Neck/Shoulder] and [Lower Back] program pages to choose your favorite programs.
- If you dislike the favorite programs in this page, you can long press the auto program icons and delete them by clicking“ x” on the right top corner and choose again.



7. Position

- Touch [Position] , enter to the Position page.
- You can adjust the raising and reclination of the backrest and the footrest by touching the icons ^ ∨.
- For LED button, here it controls the light on or off. when you touch it once and see the icon light up, then LED is on while it is off with dark icon.
- For Zero Gravity, two states for you to choose, just choose the one you prefer.
- For Upright, touch it once and chair will be in uprising state. Touch it again, it will stop the action.

NOTE:

When you are enjoying Thai Stretch or Sweet Dream massage program, Zero Gravity will not react for it is set for default.

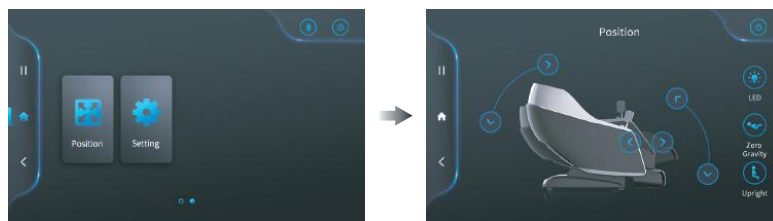

Adjust chair up or down



Adjust footrest up or down

Adjust retraction or extension of the footrest

9. Bluetooth

- Bluetooth speakers are located in the left and right shoulders so you can enjoy music or other soothing sounds as well as pick up your phone while sitting in the chair.
- Touch the  icon to control the Bluetooth.
- When you see the icon lights up, it means that the bluetooth has been turned on and you can connect the chair through your phone. The chair's bluetooth listing with which to pair is "JP-NEXUS 4D".

NOTE:

- Chair must be powered on. Bluetooth speaker will not work if the chair is powered off.
- Bluetooth speaker can only connect with one device at a time. Please turn off your bluetooth device after using so that other users can enjoy it as well.

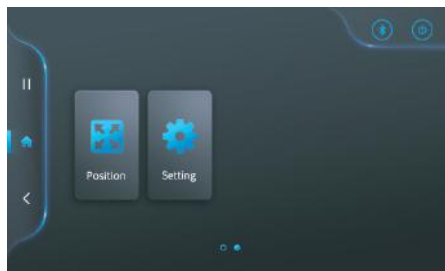





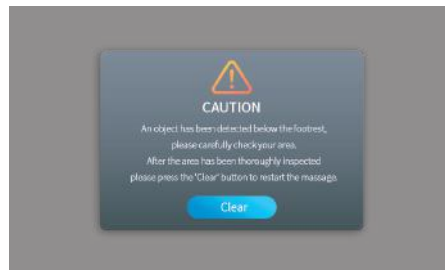











10. Pop - Up Caution

You may sometimes find a caution popping up like the below figure. Then you need to carefully check around the footrest and make sure the object has been cleared. After the area has been thoroughly inspected, please press the “Clear” button to restart massage.



Programs Description

 Joint Care	<p>This program helps to refresh and rejuvenate fatigued muscles and speeding recovery from vigorous athletic activity.</p>
 Relax	<p>This program helps provide with a slow and soft massage to help users to be in a very relaxing and calm state.</p>
 Sweet Dream	<p>A program designed to provide a mild massage that is great for deep relaxation, best used before going to sleep.</p>
 Thai Stretch	<p>Inspired by Thai style massage, featured in extension and stretching. This program uses strong kneading and stretching techniques to relax tired muscles and keep them flexible.</p>
 Blood Circulation	<p>This programs helps to improve blood circulation of the users by scraping and rolling.</p>
 Focus	<p>This programs helps to focus on certain pressure points in the back to help relieve more stress from the individual.</p>
 Yoga	<p>Inspired by Thai style massage, this program helps users to relax tired muscles and keep flexible.</p>
 Demo	<p>This program is used to help demonstrate the basic massages the chair has to offer.</p>
 Calm	<p>This program combines slow, calming massage techniques that are predictable and repeated, allowing the body and mind to release the stresses of the day through this massage-driven mediation of body and mind.</p>
 Recover	<p>This program focuses on refreshing and rejuvenating fatigued muscles and helps users to recover the body.</p>
 Care	<p>This program focuses on soothing the muscles of neck and shoulder by rolling. It helps users to relax pressure.</p>
 Shiatsu	<p>This program helps to perform a more pinpointed massage along the back. This massage style helps to focus on certain pressure points in the back targeting tense muscles.</p>

 <p>Joint Care</p>	<p>This massage focuses on your waist by special massage techniques, such as kneading, rolling and tapping. It helps to relax your body.</p>
 <p>Recover</p>	<p>This program focuses on refreshing and rejuvenating fatigued muscles and helps users to recover the body.</p>
 <p>Deep Tissue</p>	<p>This program helps to massage on certain pressure points to promote muscle relaxation, circulation, and aids post-exercise recovery.</p>
 <p>Lumbar Care</p>	<p>This massage will focus on your lower back with a deep massage that includes air compression.</p>

Voice Control

- **This chair has Voice Control capabilities. It has a tiny microphone around the right armrest which recognizes different phrases that the user can manage the massage modes by speaking.**
- **Please first use the phrase “Hey, Osaki” to wake up the chair. If the chair doesn’t react, please use the phrase again until it responds and then you can operate the chair by other preset voice commands in the below form.**

NOTE:



- **Make sure the plug is fully inserted and turn on the chair before you use the Voice Control function.**
- **The accent of users may be different so the chair may not quickly recognize the command. Please speak clearly and loudly as possible.**
- **Since the tiny microphone is near the right armrest, it may be blocked when user sits on the chair and the voice may not be recognized immediately. Please speak as louder as you can.**
- **In order to get best effect of the voice control, we suggest it better in a quiet room or chair may not recognize and response at once.**

Command	Reaction
Hey, Osaki	Yes, How can I assist?
End Massage	Sure, I hope you enjoyed your massage
Stop	Okay, I will stop now
Turn off	
Power off	
Turn on	Okay
Power on	
Pause massage	Your session is on hold
Continue massage	Resuming your Session
Higher	As you wish
Lower	I have reached the maximum angle
Increase the volume	Okay, increasing the volume
	Sorry, I can't go any louder
Decrease the volume	Okay, decreasing the volume
	I am at my lowest volume
Athletic massage	Ok, I have started the athletic massage.
Relax massage	Ok, I have started the relax massage.
Tranquil massage	Ok, I have started the tranquil massage.
Deep tissue massage	Ok, I have started the deep tissue massage.
Demo massage	Ok, I have started the demo massage.
Yoga massage	Ok, I have started the yoga massage.
Sweet dream massage	Ok, I have started the sweet dream massage.

Command	Reaction
Circulation massage	Ok, I have started the circulation massage.
Lower back massage	Ok, I have started the lower back massage.
Sensei neck and shoulder massage	Ok, I have started the sensei neck and shoulder massage.
Joint care massage	Ok, I have started the joint care massage.
Relief massage	Ok, I have started the relief massage.
Stretch massage	Ok, I have started the stretch massage.
Neck and shoulder care	Ok, I have started the neck and shoulder care.
Switch on Back Heater	Turning on Back Heater
Switch off Back Heater	Okay, turning off Back Heater
Turn on foot roller	Turning on foot roller
Turn off foot roller	Okay, turning off foot roller
Stronger	Sure, increasing intensity
Decrease strength	Alright, adjusting for you
	I have reached my maximum strength
	Sorry, I am unable to go any lighter

After Use

1. Turn off the chair by 4 operating ways.

- (1) Press the power switch on the right top of the touch screen control.
- (2) Touch power button  on the screen to power off.
- (3) Press the power switch  on the dial.
- (4) Wake up the chair first by speaking “Hey, Osaki”. Once the chair responds, you speak “End Massage” or “Turn Off” or “Power Off”, chair will be off by voice control.

2. Press the power switch from “I” position to “O” position.



3. Pull out the power plug.



CAUTION

- **DO NOT walk outside of the chair directly and immediately when the chair is still running.**
Otherwise it may cause accidents and injuries.



WARNING

- **DO NOT step on the footrest after use when you get up.**
Otherwise the footrest may be damaged.
- **Make sure you have pressed the power switch to the OFF position and pulled out the power plug.**
Otherwise accidents and injuries may happen when children play with the chair.

Cleaning and Maintenance

Cleaning of the synthetic leather

Wipe the synthetic leather with a soft dry cloth.

- Do not clean the product with solutions containing chemicals such as thinners, gasoline and alcohol.
- Be sure that leather cleaner will not harm the synthetic leather by reading the label.
- If the synthetic leather is very dirty, wipe it with the method below.
 - ① Wet a soft cloth into water or 3% to 5% neutral detergent containing hot water and wring it out.
 - ② Be sure the soft cloth is well wrung out till there is NO water dripping from the cloth.
 - ③ Wipe surface of the synthetic leather with the soft cloth.
 - ④ Be sure to rinse out the cloth multiple times when wiping down.
 - ⑤ Have the synthetic leather dry naturally. Do not use dryer.
- If it is difficult to remove the stains on the synthetic leather, try soak a piece of melamine foam into a neutral detergent to wipe down for several times.
- Do not dry the surface by a hair dryer.
- Surface of the synthetic leather may fade or discolor if an inappropriate detergent is used. Test the cleaning solution in small section prior to fully applying.
- Do not clean the hard plastic parts with any alcohol, thinner or benzene based agents. This may cause discoloring or removal of the color all together.



Cleaning of the plastic parts

1 Put a piece of soft cloth into water mixed with a neutral detergent contained hot water, wring it out and wipe the plastic parts.

- Do not clean the product with chemicals such as thinners, gasoline and alcohol.

2 Wipe down with a microcloth or soft cloth wrung out in clean water.

- Be sure the cloth is well wrung out with no water dripping, leaving the cloth damp.

3 Have the plastic parts dry naturally.



Questions and Answers (Q&A)

Q Can someone with a medical condition or disease use this product?

A They must consult with their physicians before using the product.

Massage can aggravate or worsen muscle injuries, bone disease, spinal abnormalities, skin disease and kill ones with medical devices implanted in their body.

Q Is there a restriction body height and weight to use this chair?

A The recommended min. height is 4'9" with a max. height of 6'4". The max. weight capacity is 260 lbs.

If the user is shorter or taller than the height range, They will not fit comfortably in the chair and may even cause injury. The maximum weight limit must be followed to avoid damaging the chair and also possibly seriously injuring yourself while using the device. The limits are in place for the users safety.

For a taller person with knee bending when using the product:

Tilt the backrest and lower the Lower Leg/Foot massager to the down position, elongating the length from top to bottom.

For a short person difficult to touch the foot massage section:

Raise the backrest and raise the legrest to shorten the distance from the top to bottom.

Q Where is the serial number of the product?

A It is located at behind the backrest at the back of the chair by the power cord.



Q When I use the chair it makes noise?

A It is part of the normal function of the chair.

The chair is equipped with an air pump and multiple motors. The sounds are part of chair when being operated.

Q How long should I use the massage chair each day?

A 20 minutes per day with no medical conditions.

For the 1st week of using the chair, use only for 20 minutes at most assuming the user is in good medical condition. If there is any discomfort, stop using and consult with your doctor. In the first few days of using, you may experience mild soreness. Be sure to monitor the pain levels and if the soreness does not diminish after the following days, consult with your doctor before using again.

BE SURE TO DRINK PLENTY OF WATER AFTER EACH MASSAGE.

Troubleshooting

If an issue occurs, inspect and trouble shoot according to the corresponding method below.

If the problem is not solved, contact the manufacturer for further instructions or service.

Fault	Cause and elimination method
<p>The massage wheels stop during use (The product beeps and all icons and buttons on the remote controller flicker and then go out.)</p>	<p><u>As a safety protocol, the massage heads will stop if pressure/weight load has exceeded its limit.</u> To avoid potentially over heating or damaging the massage mechanism, the chair is designed to automatically shut off if over strained or over heated. The remote will flash a few times and then shut off as a safety measure. If this has occurred, turn off the power switch from the back, allow for 30 seconds. And power back on. If the weight capacity of 260lbs is not exceeded, unplug from the outlet and notify the manufacturer.</p>
<p>The product cannot tilt, or the footrest cannot be raised or lowered (The product beeps, the running light on the remote controller go out and the product stops)</p>	<p><u>This product will stop upon any obstruction or a too large of a force preventing from operating.</u> If all screen and buttons are flickering and the backrest or the footrest has stopped, turn off the power supply and turn back on 10 seconds. Be sure there are no obstructions in the way of the footrest or the backrest rolling mechanism.</p>
<p>The massage wheels cannot reach the shoulders or the neck</p>	<p>If your head is not properly placed against the backrest during the computer body scan, it may result in an incorrect reading, causing the rollers to start a lower position causing the massage to be inaccurate. If this occurs, turn off the power from the remote and start over again to get a proper reading.</p>
<p>The left and right massage wheels have different heights (Intensities)</p>	<p>This is a normal function of the massage mechanism as it programmed to massage alternating locations from the right side during certain intervals of the program.</p>
<p>The chair is not functioning (massaging). ● Upper body (the neck to the waist) massage ● Lower leg/foot massage</p>	<ul style="list-style-type: none"> ● The power line is disconnected. ● The power switch is not turned on. ● If no program is selected after turning, the chair will pause and shut down. Turn off and restart.
<p>The roller heads are still warm after turning off the heat. Or the product is damaged.</p>	<ul style="list-style-type: none"> ● Because the roller heads heat up, it will take some time for the residual heat to dissipate. ● If the massage heads are mildly warm, the rollers may be admitting heat created by the friction from the massage.
<p>The power line or the power plug is abnormally warm to hot.</p>	<p>To avoid accidents, contact an authorized service center.</p>

If above solutions are not applicable, kindly refer to “Product Warranty Card” and contact service center.

Troubleshooting (Continued)

Expected sounds and feelings when using the massage chair.

You will hear or have the following feelings when using the product. These not defective indicators but a normal function of the chair.

- When chair extends or retracts, you will hear gears moving and clicking.
- A rubbing sound will be mildly heard when the massage heads are activated.
- When the massage heads are tapping, you may hear a mild clicking sound.
- Friction sounds will be experienced as the rollers are activated.
- As the rollers move up and down, the motors produce a sound.
- As the rollers are activated, you will hear spinning of belts rotating.
- Motor sounds will be experienced.
- As the massage heads are squeezing, a mild squeaking sound will be heard.
- When sitting in the chair as the roller heads are tapping and rolling, a mild squeaking sound may be produced from the joints.
- Common joints that may squeak would be from the side panels.
- Friction sounds between the massage wheels and the fabric.
- Motors will be heard from the pump when the airbags deflate.
- While the airbags are activated, you will hear air valves alternating.



If the sound is loud, it is also possible that the product has failed.

- In this case, have the product inspected and repaired by an authorized service center.

Warning

- **Do not refit, disassemble or repair the product without permission.** Otherwise fires, abnormal movements or personal injuries may happen.

Warning

- **In the case of any abnormality or fault, stop the product immediately and pull out the power plug to avoid fuming, fires and electric shocks.**
 - **<Abnormality and fault example>**
 - The product fails to work after the power switch is turned to the ON position;
 - When the power cable is moved, the chair will turn off and on.
 - In use, the product gives off a burning smell or an abnormal sound.
 - The product upholstery is deformed or abnormally hot.
- If any of these symptoms occur, have the product inspected and repaired by an authorized service center immediately.

Specifications

Product name		JP-NEXUS 4D
Rated Voltage		110-120V 60Hz
Current		1.25A
Working time		15min
Guide		L Shape 53.2"
4D Massage Roller	Forward arc distance	6 Levels Approx 3.74"
	Strength	5 levels
	Speed	5 levels
Airbag	Intensity	5 levels
Angle Adjustment	Backrest	Approx 128°-155°(Ground Angle)
	Footrest	Approx 9°-75°(Wall Angle)
size	Upright	62.4" x 31.5" x 48.2"
	Reclined	70.1" x 31.5" x 42.3"
Extension of Footrest		Approx 7.1"
Dimensions of Packing (L*W*H)		BOX 1: 57.9" x 33.5" x 49.0" BOX 2: 23.2" x 20.1" x 21.7"
N.W./ G.W.		BOX 1: 202.8 lbs/238.1 lbs BOX 2: 46.3 lbs/52.9 lbs
Weight of Chair		Approx 249.1 lbs
Usage Condition		Environment temperature : "32°F-95°F" Contrasting humidity : "20-80RH"
Storage Condition		Storage temperature : "23°F-95°F" Storage humidity : "20-80RH"
Maximum body weight of user		260 lbs

FCC Radiation Exposure Statement

FCC Radiation Exposure Statement: (mobile device)

This equipment complies with FCC radiation exposure limits set forth for an uncontrolled environment. In order to avoid the possibility of exceeding the FCC radio frequency exposure limits, Human proximity to the antenna shall not be less than 20cm (8 inches) during normal operation.

FCC STATEMENT

1. This device complies with Part 15 of the FCC Rules. Operation is subject to the following two conditions:
 - (1) This device may not cause harmful interference, and
 - (2) This device must accept any interference received, including interference that may cause undesired operation.
2. Changes or modifications not expressly approved by the party responsible for compliance could void the user's authority to operate the equipment.

This equipment has been tested and found to comply with the limits for a Class B digital device, pursuant to part 15 of the FCC Rules. These limits are designed to provide reasonable protection against harmful interference in a residential installation. This equipment generates, uses and can radiate radio frequency energy and, if not installed and used in accordance with the instructions, may cause harmful interference to radio communications. However, there is no guarantee that interference will not occur in a particular installation. If this equipment does cause harmful interference to radio or television reception, which can be determined by turning the equipment off and on, the user is encouraged to try to correct the interference by one or more of the following measures:

- Reorient or relocate the receiving antenna.
- Increase the separation between the equipment and receiver.
- Connect the equipment into an outlet on a circuit different from that to which the receiver is connected.
- Consult the dealer or an experienced radio/ TV technician for help.

Industry Canada Notice

Industry Canada Notice

This device complies with Industry Canada licence-exempt RSS standard(s).

1. Operation is subject to the following two conditions:

(1) this device may not cause interference, and

(2) this device must accept any interference, including interference that may cause undesired operation of the device.

2. Changes or modifications not expressly approved by the party responsible for compliance could void the user's authority to operate the equipment.

Avis d'Industrie Canada

Le présent appareil est conforme aux CNR d'Industrie Canada applicables aux appareils radio exempts de licence.

1. L'exploitation est autorisée aux deux conditions suivantes :

(1) l'appareil ne doit pas produire de brouillage, et

(2) l'utilisateur de l'appareil doit accepter tout brouillage radioélectrique subi, même si le brouillage est susceptible d'en compromettre le fonctionnement.

2. Cet appareil numérique ne dépasse pas les Rèlements sur l'interférence radio par un appareil numérique de classe B stipulées dans les Règlement sur l'interférence radio d'industrie Canada.

