

Osaki **Δi** **SERIES**

OS - Flagship 4D

INSTRUCTION MANUAL

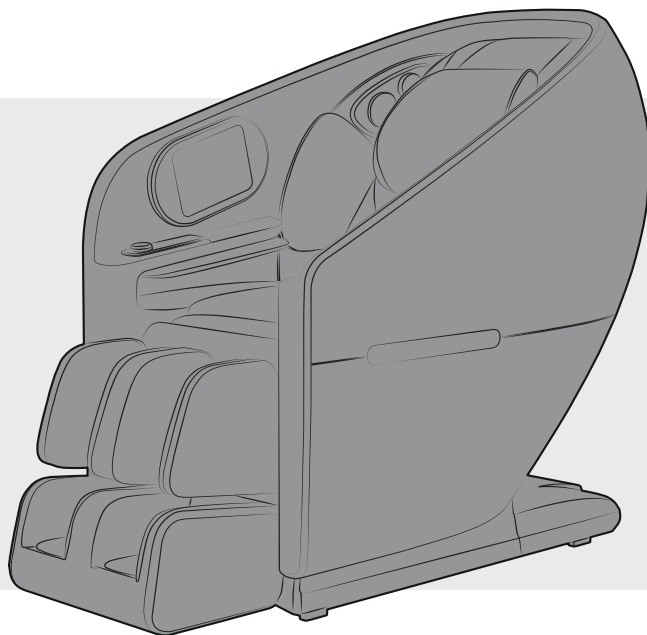

Please read all instructions carefully before using.

Thank you for purchasing this product.
Please read this user manual carefully before using to ensure proper installation and operation.
Please keep this USER MANUAL properly for future reference.

CONTENTS

SAFETY PRECAUTIONS

NAME AND FUNCTION OF EACH COMPONENT

External Structure	4
Internal Structure	4
Quick Buttons	5
Instructions for Quick Buttons	6
Touchscreen Controller User Guide	7
Functions And Features	8

PRELIMINARY CHECKS

Installation Method	9
Moving the Massage Chair	11
Connecting to Power	11
Position & Placement for Installation	12
Floor Protection	13
Surrounding Environment	13
Grounding	13
Commissioning	14
Before Sitting in the Chair	14
After Use	15

PRODUCT CARE AND STORAGE





TROUBLESHOOTING

TECHNICAL SPECIFICATIONS

SAFETY PRECAUTIONS

Safety Precautions

- ▶ Before using, please read the SAFETY PRECAUTIONS carefully to ensure correct operation of this appliance.
- ▶ Precautions and warnings listed below will help to ensure proper operation of this appliance.
- ▶ The classes of accidents caused by incorrect use are classified into WARNING and CAUTION. Read all WARNINGS and CAUTIONS below and follow all instructions within this manual.

	WARNING	Improper operation may cause injury to users.
	CAUTION	Improper operation may cause injury to users or damage to product.
	Prohibited	
		NO Disassemble

Not suitable for below persons

We recommend that those with any of the following conditions should consult your physician before using.

 WARNING	<ul style="list-style-type: none"> ◆ Those with pacemaker or electronic devices implanted in the body. ◆ Those undergoing treatment, especially those who are not feeling well. ◆ Those with malignant tumors, acute disease, heart disease or severe hypertension. ◆ Need to be supervised. ◆ Women who are pregnant or menstruating. ◆ Those with osteoporosis, distorted joints, dysfunction or recent fracture. ◆ Those with serious or injured skin conditions. ◆ Those with high fever. ◆ The appliance has a heated surface. Persons insensitive to heat must be careful when using the appliance. (Need to be supervised) ◆ This appliance is not intended for use by persons (including children) with reduced physical, sensory or mental capabilities, or lack of experience and knowledge, unless they have been given supervision or instruction concerning use of the appliance by a person responsible for their safety. ◆ This appliance can be used by children aged from 8 years and above and persons with reduced physical, sensory or mental capabilities or lack of experience and knowledge if they have been given supervision or instruction concerning use of the appliance in a safe way and understand the hazards involved.
---	---

Controller Precautions

 CAUTION	<ul style="list-style-type: none"> ◆ Do not operate the controller with wet hands or pull the controller wire by force. ◆ Do not spill water or other liquid into the controller to avoid fault. ◆ Do not lay heavy items on the controller.
---	---

Cautions Regarding the Power Connectors and Power Cord





 CAUTION	<ul style="list-style-type: none"> ◆ The appliance is only to be used with the power supply unit provided with the appliance. ◆ It must only be supplied at safety extra low voltage corresponding to the marking on the appliance. ◆ Do not use a wet hand to unplug the AC cord to avoid electric shock. ◆ Do not pull on the power cord, reach to the front end to unplug it. ◆ Do not squeeze the power cord by heavy objects. ◆ Do not damage, over bend, pull hard or twist the power cord. ◆ If the supply cord is damaged, it must be replaced by the manufacturer or its service agent or a similarly qualified person in order to avoid a hazard.
---	--

SAFETY PRECAUTIONS

Best Circumstances

 CAUTION	<ul style="list-style-type: none"> ◆ Do not use this appliance where temperature is over 40 C . ◆ Do not use this appliance in moist or dusty environment. ◆ Unplug from outlet during thunder or lightening storms. ◆ Do not use outdoors. ◆ Please place the product on the flat level floor. ◆ Do not store near heat or open flame.
---	---

Best Practices for Safe Use

 CAUTION	<ul style="list-style-type: none"> ◆ Only for users weighs below 120kg. ◆ Do not use other therapeutic device together with this product. ◆ Use this product only for its intended use as described in this manual. ◆ Appliance should only be used by one person,do not use by two or more persons at the same time to avoid damage to the products. ◆ Do not use the product right after meal, it may cause discomfort. ◆ Remove the accessories from the arms and empty the pockets while use the massage services. ◆ Check the upholstery under the cushions and other spots, if any damages are present, do not use it and refer to a qualified service professional for servicing. ◆ If you feel any abnormal discomfort during the operation of this product, turn off the power immediately and do not use the product. ◆ Use the appliance for 20 minutes each time is highly recommended. ◆ Make sure there is no obstacles behind the chair and there is enough clearance before adjusting the backrest or footrest angle ◆ Make sure no other excessive load pressed on the backrest or footrest,keep children,pets or any other barrier away from the unit reclining backrest/extending footrest to prevent any accidental injury. ◆ Please be seated properly while using the appliance to avoid injury to the user or damage to the appliance. ◆ Do not drag or push the chair or roll on its casters on wood floor or carpet to avoid damage.
 PROHIBITED	<ul style="list-style-type: none"> ◆ Never operate this product if it has damaged /exposed parts or power leakage. ◆ Do not stand on or stack heavy objects on the footrest. ◆ Children should be supervised to ensure that they do not play with the massage chair. ◆ Do not fall into sleep while the product is operating. ◆ Avoid using the product under the influence of alcohol. ◆ Do not put hands or foreign objects in the openings of the appliance to avoid injury to the user or damage to the appliance. ◆ If there is any smoke or unusual smell during operation,stop using immediately.
 NO DISASSEMBLE	<ul style="list-style-type: none"> ◆ Do not disassemble this product to avoid failure. ◆ Do not attempt to repair or dismantle the appliance without permission. ◆ Please contact authorized dealer or service agent.
 UNPLUG POWER CORD	<ul style="list-style-type: none"> ◆ Pull out the power cord from the power strips before maintenance. ◆ Never plug in or pull out power cord with wet hand to avoid shock or injury. ◆ Pull out the power cord from the power strips after use. ◆ Unplug from outlet when the power supply is cut.

IMPORTANT SAFETY INSTRUCTIONS

When using an electrical appliance, basic precautions should always be followed, including the following:

Read all instructions before using (this appliance).

DANGER – To reduce the risk of electric shock:

1) Always unplug this appliance from the electrical outlet immediately after using and before cleaning.

WARNING – To reduce the risk of burns, fire, electric shock, or injury to persons:

1) An appliance should never be left unattended when plugged in. Unplug from outlet when not in use, and before putting on or taking off parts.

2) Do not operate under blanket or pillow. Excessive heating can occur and cause fire, electric shock, or injury to persons.

3) Close supervision is necessary when this appliance is used by, on, or near children, invalids, or disabled persons. Keep children away from extended foot support (or other similar parts).

4) Use this appliance only for its intended use as described in this manual. Do not use attachments not recommended by the manufacturer.

5) Never operate this appliance if it has a damaged cord or plug, if it is not working properly, if it has been dropped or damaged, or dropped into water. Return the appliance to a service center for examination and repair.

6) Do not carry this appliance by supply cord or use cord as a handle.

7) Keep the cord away from heated surfaces.

8) Never operate the appliance with the air openings blocked. Keep the air openings free of lint, hair, and the like.

9) Connect this appliance to a properly grounded outlet only. See Grounding Instructions.

10) Never drop or insert any object into any opening.

11) Do not use outdoors.

12) Do not operate where aerosol (spray) products are being used or where oxygen is being administered.

13) To disconnect, turn all controls to the off position, then remove plug from outlet.

14) Use heated surfaces carefully. May cause serious burns. Do not use over insensitive skin areas or in the presence of poor circulation. The unattended use of heat by children or incapacitated persons may be dangerous.

15) Do not use massager in close proximity to loose clothing or jewelry.

16) Keep long hair away from massager while in use.

SAVE THESE INSTRUCTIONS

Household use only

WARNING: DISCONNECT FROM SUPPLY CIRCUIT BEFORE OPENING.

AVERTISSEMENT: DÉCONNECTER DU CIRCUIT D'ALIMENTATION AVANT D'OUVRIER.

▶ NAME AND FUNCTION OF EACH COMPONENT

External Structure

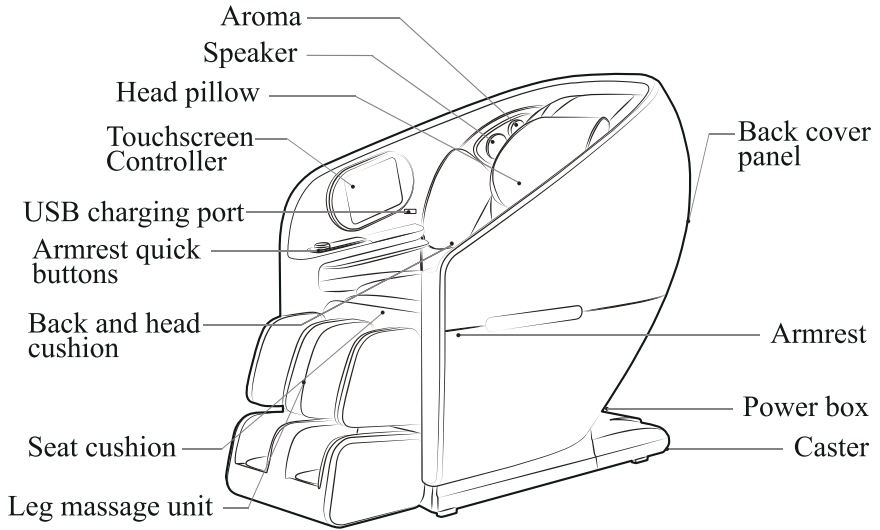

Internal Structure

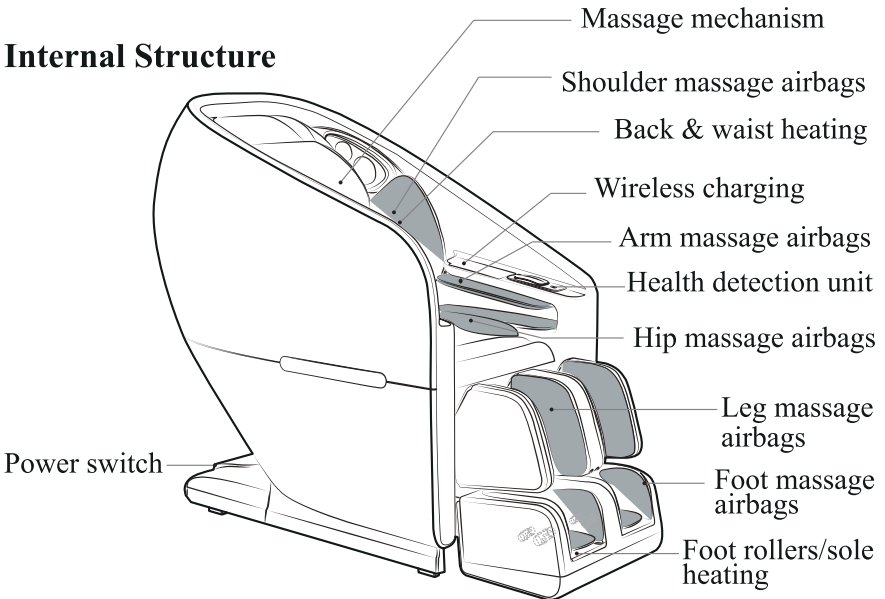

NAME AND FUNCTION OF EACH COMPONENT

Quick Buttons



▶ NAME AND FUNCTION OF EACH COMPONENT

Instructions for Quick Buttons



Power/Auto massage

▶ Long press this button to switch on/off the power; short press this button to toggle auto programs, tap with finger for Fingerprint Authentication and power on/off.



Rotary Switch

▶ Rotate counterclockwise to decrease intelligent intensity, Rotate clockwise to increase intelligent intensity.



Smart Massage

▶ Tap Intelligent Massage to go to Health Detection page, follow the guides for Body Scan, Heart Rate Detection and Soreness & Pain Detection. It will generate Health Report and start Intelligent Massage afterwards.



Health Detection

▶ Tap Intelligent Massage to go to Health Detection page, follow the guides step by step. Heart Rate Detection will show the current heart rate, and after Soreness & Pain Detection, it will develop a Health Improvement Plan and generate an Intelligent Massage Automatically.



Shoulder Position



Shoulder Position

▶ You may move the mechanism up/down by pressing the mechanism up/down adjustment button while in the body scan procedure.



Back

Back Up/Down

▶ Press and hold to Incline/ recline the backrest; release/ Low button to stop.



zero

Zero Gravity

▶ Short press to toggle among Zero Gravity position 1, Zero Gravity position 2 and Zero Gravity position off.



Leg

Feet Up/Down

▶ Press and hold to lower the footrest, release the button to stop.



▶ NAME AND FUNCTION OF EACH COMPONENT



Heating

▶ Short press to turn on Heating function. Press again to turn off Heating.



Sole Massage

▶ Short Press to toggle among Foot Roller speed level 1, Foot Roller speed level 2 and Foot Roller Off.



Airbags

▶ Short press this button to select air pressure intensity, you may toggle among 1-5 intensity settings under Auto mode or 0-5 intensity settings under manual mode.



Child Lock

▶ Press both Airbags and Heating button for 2 seconds to activate/deactivate Child lock function.

Touchscreen Controller User Guide

▶ See the “Touchscreen Controller User Guide” at touch screen controller display.



▶ NAME AND FUNCTION OF EACH COMPONENT

Functions And Features

1. Slider and Recliner

Slider recliner linkage mechanism to save space and provide utmost relaxing position.

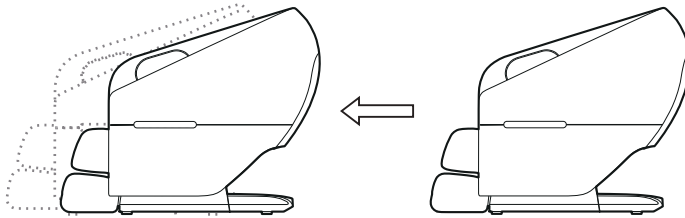

2. Zero Gravity Positions

Developed by NASA scientists, the Zero Gravity technology has been incorporated into our massage chair design, at such a weightless position that the height of the legs is slightly higher than the upper body, the weight of the body can be evenly distributed throughout, reducing the pressure of the spine and joints both physically and mentally.

3. Auto/Manual Footrest Extension

The upper legrest can extend by 7cm and the lower footrest can extend by 18cm automatically for various users with different statures.

4. Air Pressure Massage

Whole body air pressure massage for shoulders, arms, hips, legs, and feet.

5. Roller Massage

Two rows of underfoot rollers provide hand simulation rolling and Shiatsu massage for the reflex zone.

6. Versatile Massage Techniques

15 Massage Techniques with sole heating function: Kneading (Clockwise Kneading, lightly Kneading, Interval Kneading), Sync (Clockwise, Circular, Interval), Tapping (Continuous, Rhythmic, Variable-frequency), Shiatsu (Regular, Tui Na, bone cracking) Knocking (Short, Medium, Long).

▶ PRELIMINARY CHECKS

Installation Method

Step 1, Install the Footrest Unit

- ▶ Raise the legrest unit, thread the air hose into the air nozzle, and fit the air valve plug into the air valve port which located at the face side of seat base, make sure they are well secured.

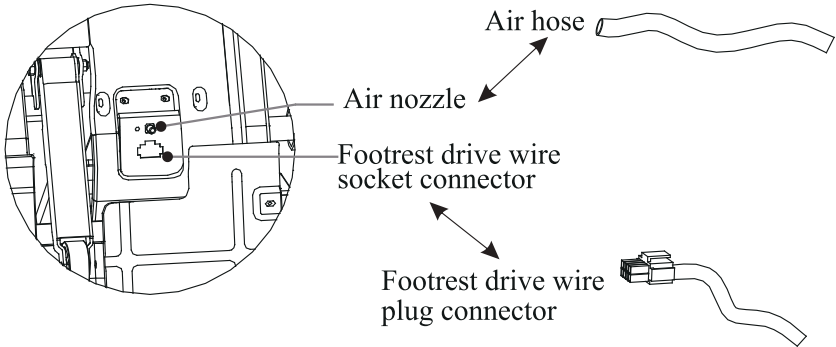

- ▶ Attach the legrest bracket onto the legrest rotation shaft, then attach a DK circlip to the end of the legrest rotation shaft to hold the legrest in place, then zip the footrest and main chair together.

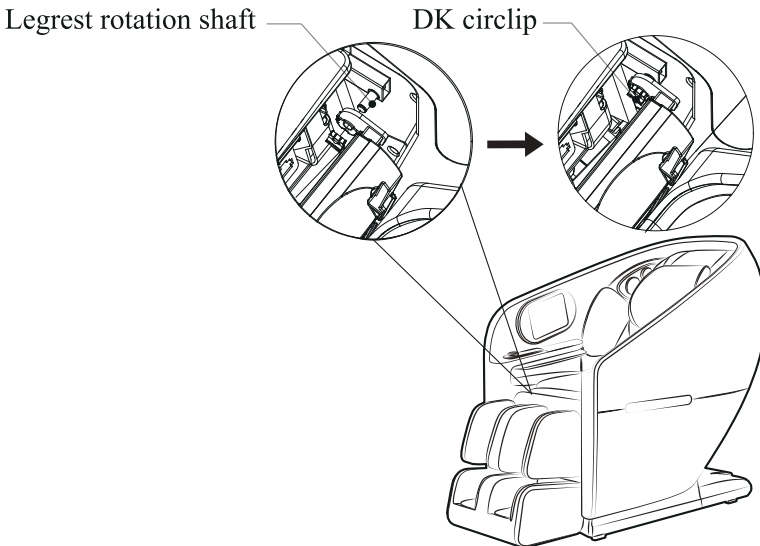

▶ PRELIMINARY CHECKS

Step 2, Install the other accessories.

- ▶ Connect the power cable to the product power socket located at the power box.;
- ▶ Connect power to chair,switch ON the power button,use the controller to raise the backrest to fully upright position.

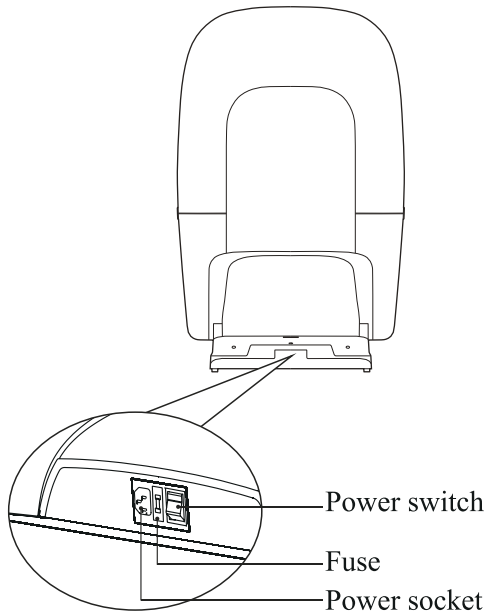

▶ PRELIMINARY CHECKS

Moving the Massage Chair

- ▶ Roll the chair on its casters to the desired location.
- ▶ Incline the backrest to upright position.
- ▶ Turn off the power switch and unplug the appliance from the electrical outlet.
- ▶ Using two people, push down on the backrest and lift up on the front side by grabbing the moving Holder located to the front bottom of the armrest, roll the chair on its casters to the desired location (check the sketch for reference).

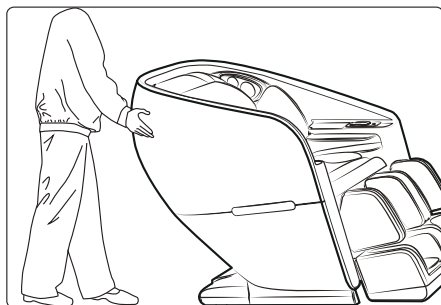

CAUTION

- ▶ Do not move the chair when there is user inside.
- ▶ To carry this product, do not lift by the footrest or armrest, hold the chassis and steady the backrest (have 4 or more people to carry the product).

Connecting to Power

- ▶ Connect this appliance to a 3-wire properly grounded outlet.
- ▶ Turn on the main power switch by the right hand side of the massage chair.

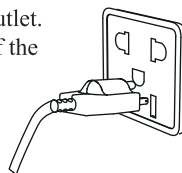

CAUTION

- ▶ Please verify that there is no damage to the supply cord before switching on the massage chair.
- ▶ Please verify that the main power switch is turned off before connecting to power.

► PRELIMINARY CHECKS

Position & Placement for Installation

Clearance space for the massage chair:

- Ensure there is an adequate clearance for the installation: It needs 8cm clearance for the reclining of the backrest; It needs 60cm clearance space for the extension of footrest and sliding forward of the chair.
- Keep it 1 meter away from the TV, radio or other audio/video appliance to avoid signal interference.

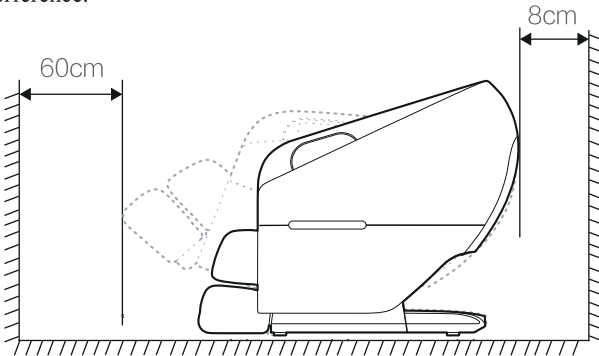

- Keep the distance between the power socket and power switch within 1.5 meters.

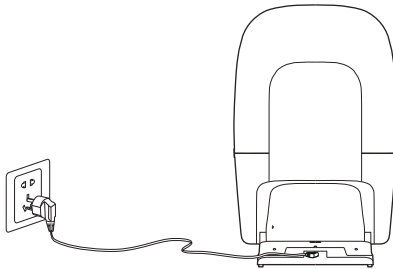

CAUTION

- Keep the distance between the power socket and power switch within 1.5 meter to avoid damage of power cord while massage chair sliding forward.
- Straighten the power cord while in use to avoid tangle or damage.
- When the massage chair is sliding forwards or back, please check to make sure there are no children, pets or other obstacles around to avoid accident.

▶ PRELIMINARY CHECKS

Floor Protection

- ▶ We recommend to place a piece of carpet or soft mat underneath it to avoid damaging the floor.

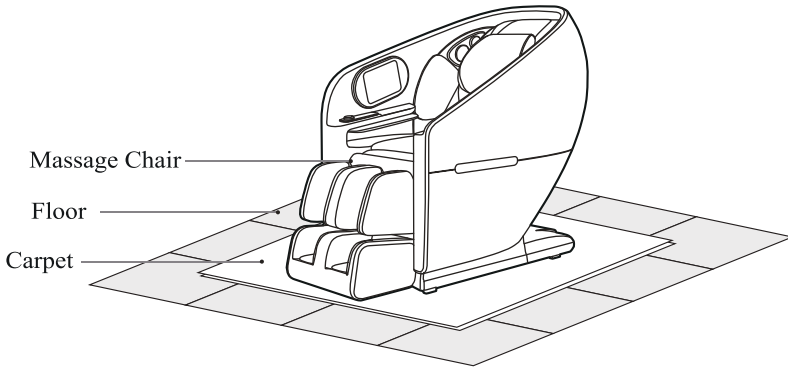

Surrounding Environment



Do not use the massage chair in high moisture environment such as near swimming pool or bathroom to prevent electric shock accident.



Please keep the massage chair away from heated surfaces to prevent fire hazard or damage to the product.

Grounding



This product must be grounded, the plug must be plugged into an appropriate 3-wire grounded outlet that is properly installed and grounded in accordance with all local codes and ordinances to reduce risk of electrical shock.

▶ PRELIMINARY CHECKS

Commissioning

- ▶ Use the controller to recline the backrest to its lowest position, raise and extend the footrest to its top position, make sure there is enough clearance before commissioning.
- ▶ Return the backrest and footrest back to its default position after commissioning and turn off the power switch. (To choose the massage program, please check the Instructions of Quick Buttons and Instructions of Touchscreen Controller for reference).

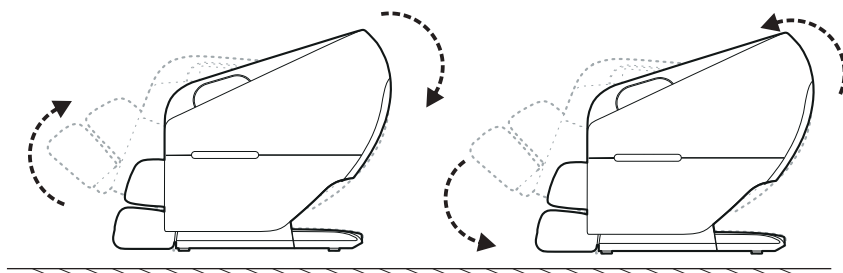

Before Sitting in the Chair

- ▶ Ensure the footrest is well assembled before sitting on the massage chair.
- ▶ Ensure the massage chair is returned to its original position before sitting on it. If there is any part not in default position, please turn on the massage chair to allow it to restore.



CAUTION

- ▶ Do not take seat while the legrest is lifted.
- ▶ Do not put excessive load on the legrest to avoid damage.



WARNING

- ▶ Do not play on the massage chair or operate it improperly.
- ▶ Ensure there is no obstruction when raising or reclining the backrest and footrest.
- ▶ Do not put foot, fingers or any other objects in the openings of the chair when it is in the reclining, raising or restoring motion.
- ▶ Ensure that massage chair is restored back to its original position before getting off the massage chair.

PRELIMINARY CHECKS

After Use

- ▶ Always unplug the massage chair from the electrical outlet immediately after use.
- ▶ Put the Touchscreen Controller onto the holder.
- ▶ Turn off the power switch and unplug the massage chair from the electrical outlet while not in use to avoid children power on the massage chair accidentally.
- ▶ When not in use for a long period of time, we recommend that the chair be covered, the power cord be coiled and that the unit be placed in an environment free of dust and moisture.

▶ PRODUCT CARE AND STORAGE

Care Instructions

- ▶ To treat stains on back panel, armrest, footrest, plastic parts or air hose, spot clean with mild detergent foam, then wipe it with a dry cleaning cloth.
- ▶ To treat stains on controller, power box, spot clean with a dry cleaning cloth.
- ▶ To treat stains on back cushion or pillows, use a water-based upholstery cleaner only, wipe it with moist cloth, then air dry.
- ▶ To clean the foot/calf unit covers, remove it from the chair, hand wash with a mild detergent, then line dry.

WARNING

- ▶ Children shall not play with the appliance. Cleaning and user maintenance shall not be made by children without supervision.
- ▶ Pull out the power cord from the power strips before care and maintenance.
- ▶ To avoid electrical shock or injury, do not touch the power cord with wet hands.
- ▶ Make sure no detergent enter into the power box while cleaning.
- ▶ Do not use benzene, thinner or other solvents on your product, it may cause fading or damage to the product.
- ▶ Do not iron the upholstery.

Storage Methods

- ▶ Cover the product with a dust-free cloth to prevent collection of dust if not in use of a long period of time.

CAUTION

- ▶ Do not leave this product exposed to direct sunlight for long periods of time. This may cause fading or damage.

Warm Tips

- During daily use, please check for the following symptoms:
- ▶ Burnt smell.
 - ▶ Power flickers on and off when touching the charging cable.
 - ▶ The power cord is hot.
 - ▶ Other abnormal symptoms.

CAUTION

- ▶ Please stop using the product to avoid breakdowns or accidents if any above symptom exists.
- ▶ Switch off the power button and disconnect the plug, contact the local distributors or supplier for repair.
- ▶ All other servicing except above care and maintenance should be serviced by an authorized dealer or service center.



WARNING

Pull out the power cord from the power strips before care and maintenance. To avoid electrical shock or injury, do not touch the power cord with wet hands. Do not try to dismantle or repair the product yourself, please send your massage chair to the authorized service center.

▶ TROUBLESHOOTING

No.	Symptoms	Possible Causes	Possible Solutions
1	Noise is heard while in use	This sound is normal and comes from the air pump motor or other mechanical parts rubbing against the cloth cover	No need to take any measures
2	Appliance does not start	The power cord is not secured into the socket	Insert the power plug properly into the power socket
		Power switch is off	Turn on the switch
		The fuse is blown	Replace only with a fuse of same type and rating
3	No music comes from the speaker	The volume is turned to the lowest	Adjust the speaker volume from the mobile devices
		Bluetooth is off	Switch on Bluetooth
		Bluetooth connected with other device	Reconnect Bluetooth
4	Backrest or footrest can not raise or recline	Excessive load has been pressed on the backrest or legrest	Reduce the load and try again
5	Airbag malfunction	The air hose is blocked	Straight the air hose and clear out the blockage

If problem remains, please contact the dealer for maintenance.

Important: Do not attempt to repair this product yourself, our company shall not be liable for the injury or damage caused by any servicing without authorization.

▶ TECHNICAL SPECIFICATIONS

Name: Osaki OS - Flagship 4D Massage Chair

Model: OS - Flagship 4D

Rated voltage: 110-120V~

Rated frequency: 50-60Hz

Rated current: 0.9A

Safety design: Class I