



JPMEDICS

User Manual
JPM60/KaZe

www.jpmedics.com

We Can Help.

Our team will respond quickly to help you solve any issues

1.877.977.0656

Need a deeper massage?
Remove Softening Pad

- 1** Unzip
- 2** Fold Down
- 3** Remove Pad

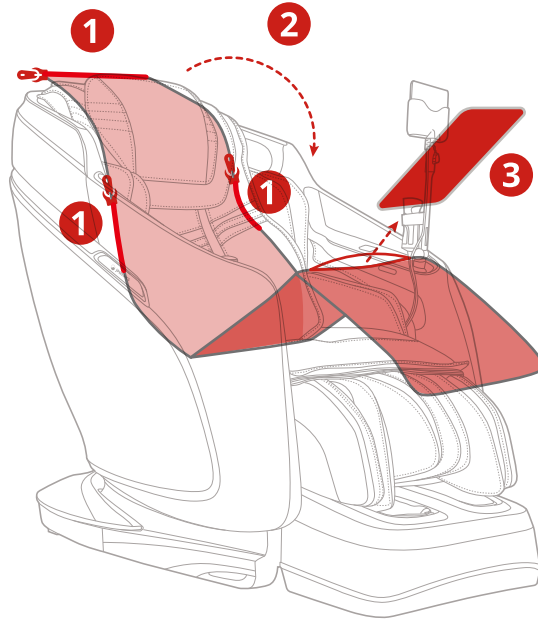

Scan QR Code to Visit Website



Scan QR Code for Operation Video



Scan QR Code for Service Support



For replacement parts and tech support, please call our service and warranty phone number, or visit www.jpmedics.com

TABLE OF CONTENTS

 INTRO	Dimensions	3
	Contents	4
 CHAIR	Move & Clearance	5
	Components	6
	Massage Points	7
	Specifications	8
 MESSAGE	Interface	9-12
	Auto Massage	13-18
	Demo	19-20
	Custom Massage	21-27
	Spot Massage	28-30
	Chair Doctor	31-34
	Settings	35-45
	Application Interface	46-68
Auto Program Descriptions	69-74	
 CARE	Safety	75-77
	Grounding Instruction	77
	Product Cleaning	78
	Warranty	78

DIMENSIONS

First, let's get your chair inside.

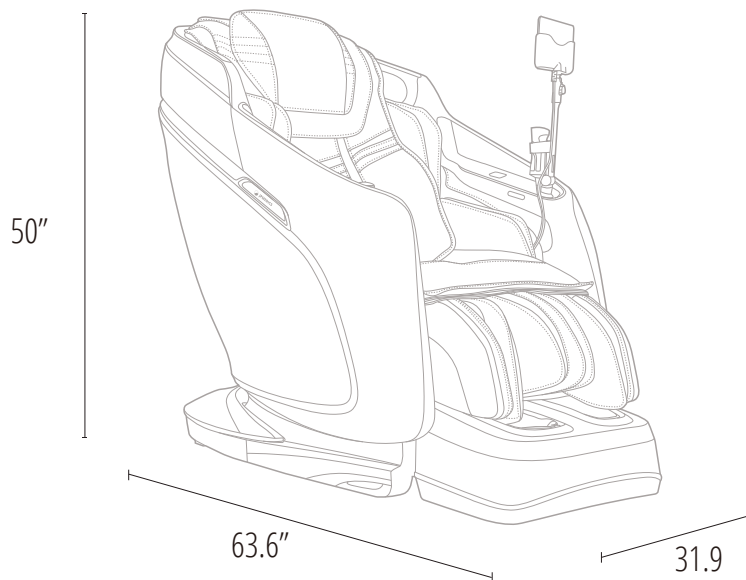

Box 1

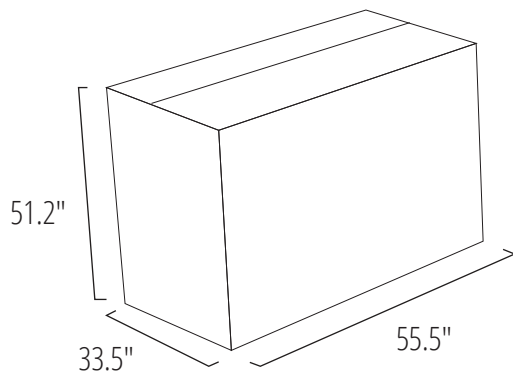

Base & Backrest

Box 2

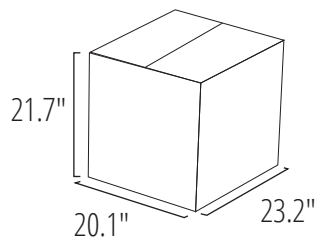

Footrest

CONTENTS

Everything you need for a relaxing experience.



User Manual



Installation Manual

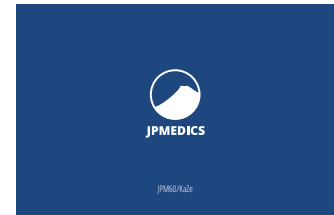

Warranty Postcard

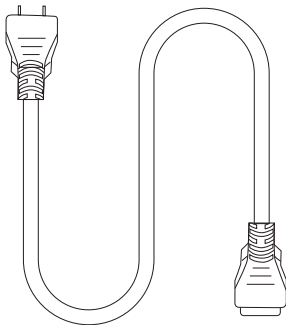

Power Cord

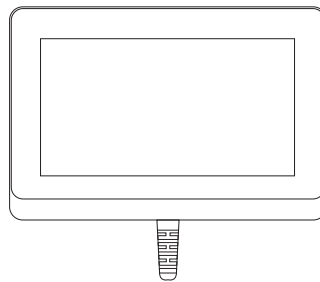

Wired Touch-Pad



JPM60/KaZe Massage Chair

Move & Clearance

A few simple steps to find the best place for your new chair.

HOW TO MOVE

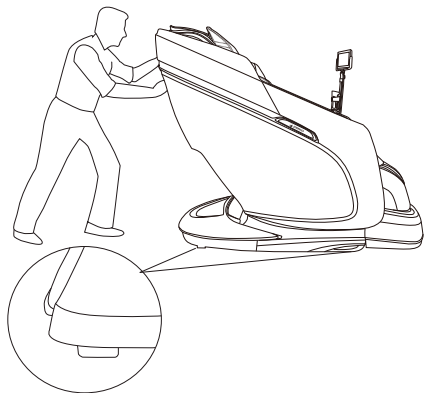

Move with a slight pull or push

Caution: If you roll the chair on wood floor, marks may be left

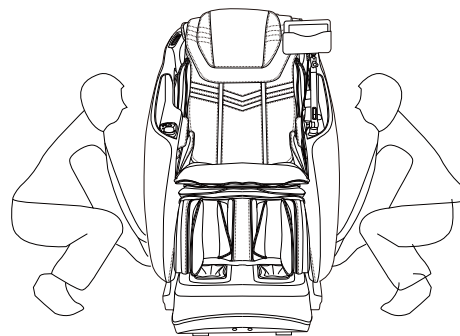

Two people are needed to lift the chair

CLEARANCE

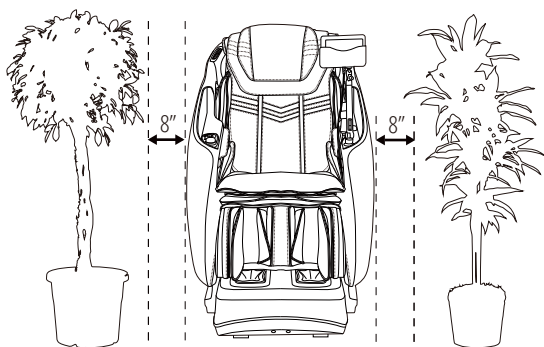

Reserve space on the left and right

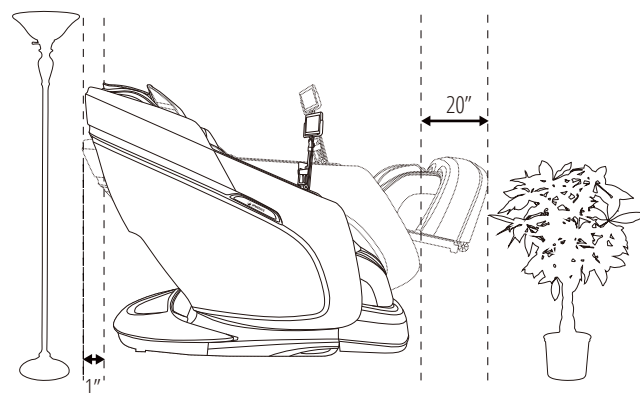

Reserve space on the front and back

CHAIR COMPONENTS

Some of your chair's most important features.

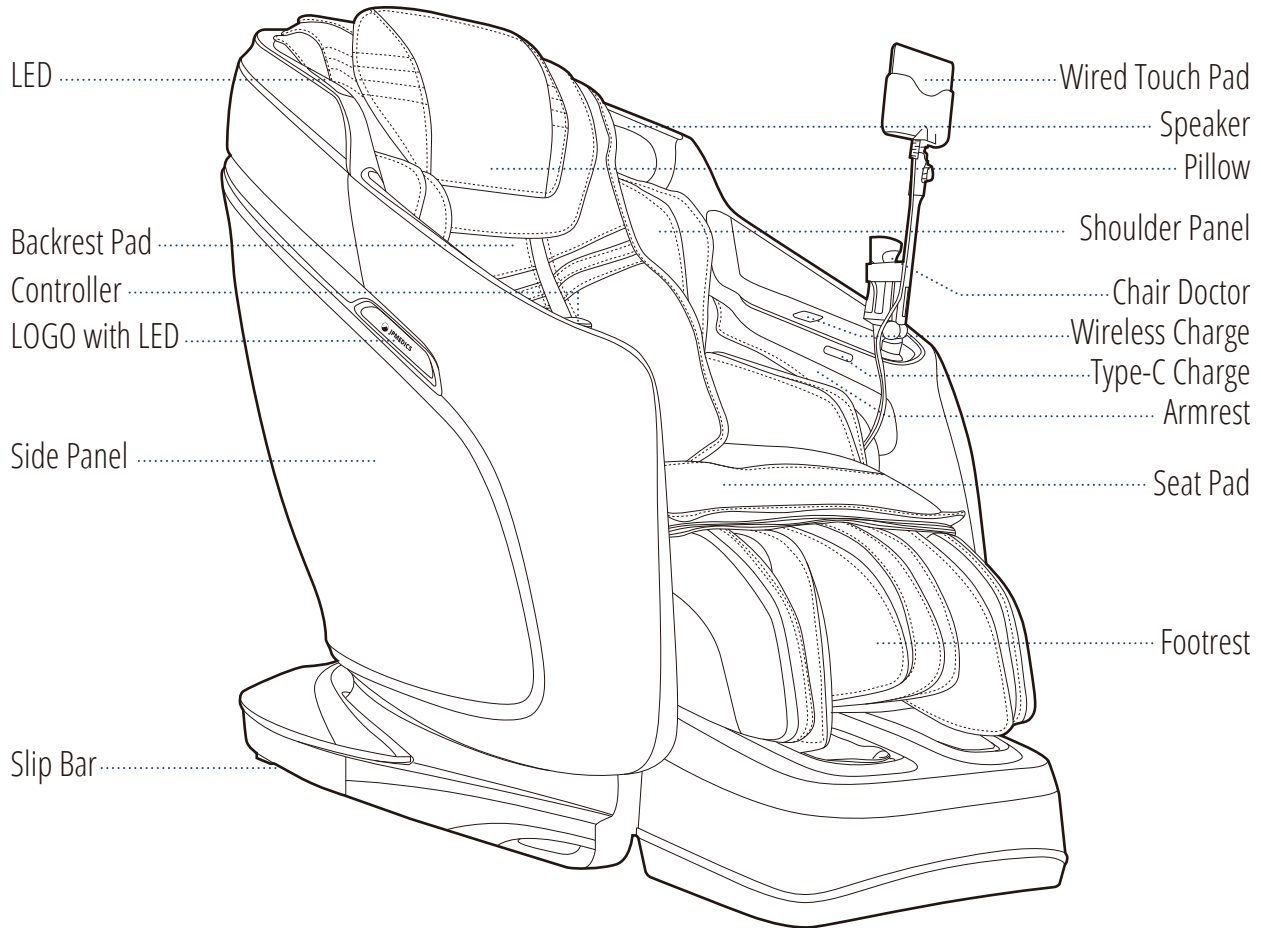

Note: The speaker will only operate when the massage chair is in operation



To play music using your massage chair's speakers please connect your smartphone, tablet, or other electronic device to your chair using bluetooth. Note that the code to connect the bluetooth is KaZe.

MASSAGE POINTS

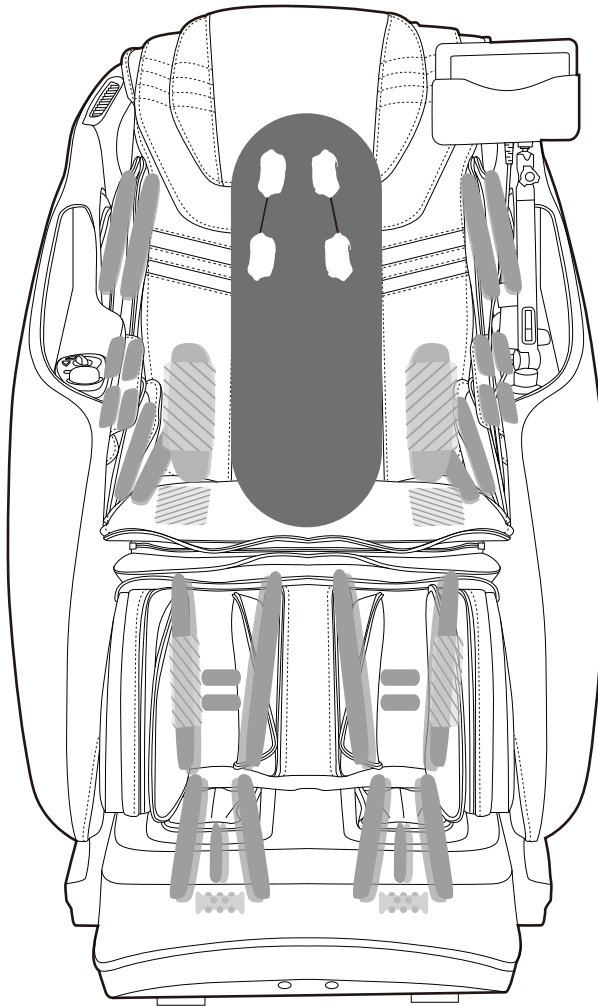

22 Air Bags
2 Heat Pad On Lumbar
2 Heat Pad On Seat

22 Air Bags
2 Heat Pad On Leg
Foot Rollers with Leg
Kneading Massage

● Back Massage Mode ● Air Bag ● Roller ● Heating Pads

CHAIR SPECIFICATIONS

A few important facts about your massage chair.



Model No.
JPM60/KaZe



Massage Time
5 to 30 minutes

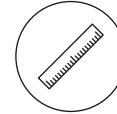

Dimensions (L x W x H)
Chair dimensions: 63.6" x 31.9" x 50"
Reclined dimensions: 73.7" x 31.9" x 41.5"



Shipping Weight
Gross weight: 292.1 lbs
Net weight: 250.4 lbs

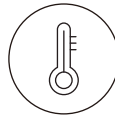

Usage Condition
Environment temperature: 10°C-40°C
Contrasting humidity: 30-85RH

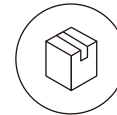

Storage Condition
Storage temperature: -20°C-60°C
Storage humidity level: 30-85RH



Rated Current
1.25A



Rated Voltage
110 - 120V



Rated Frequency
60Hz



Power of Speakers
14W (2 sides)



Length of Wiring
Controller wiring: 27.6"
Power supply wiring: 70.9"



Safety Feature
Equipped with child safety lock,
leg rest and backrest safety sensor,
and overheating and power surge detectors

WIRED TOUCH-PAD INTERFACE

We have designed your massage chair's tablet controller with a user-friendly interface to make using your chair even easier.

Home Screen

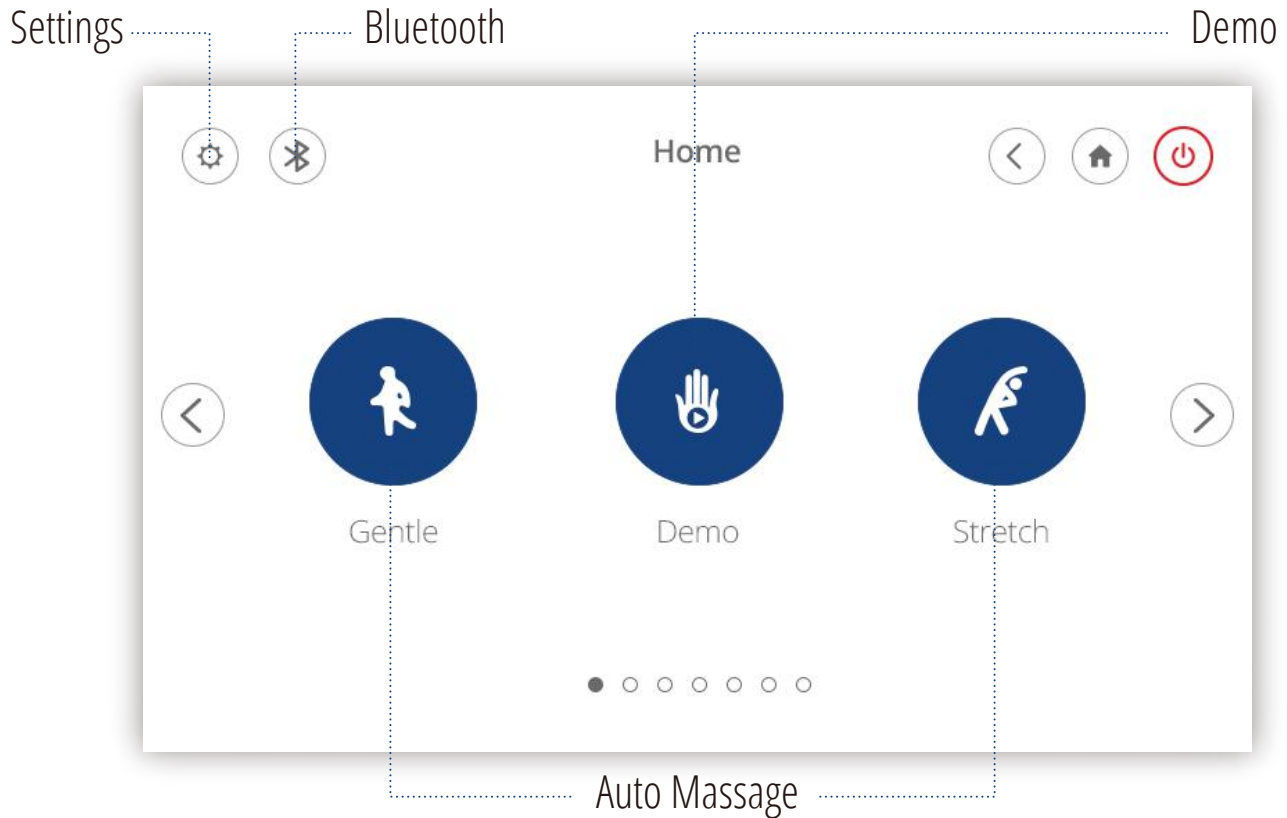

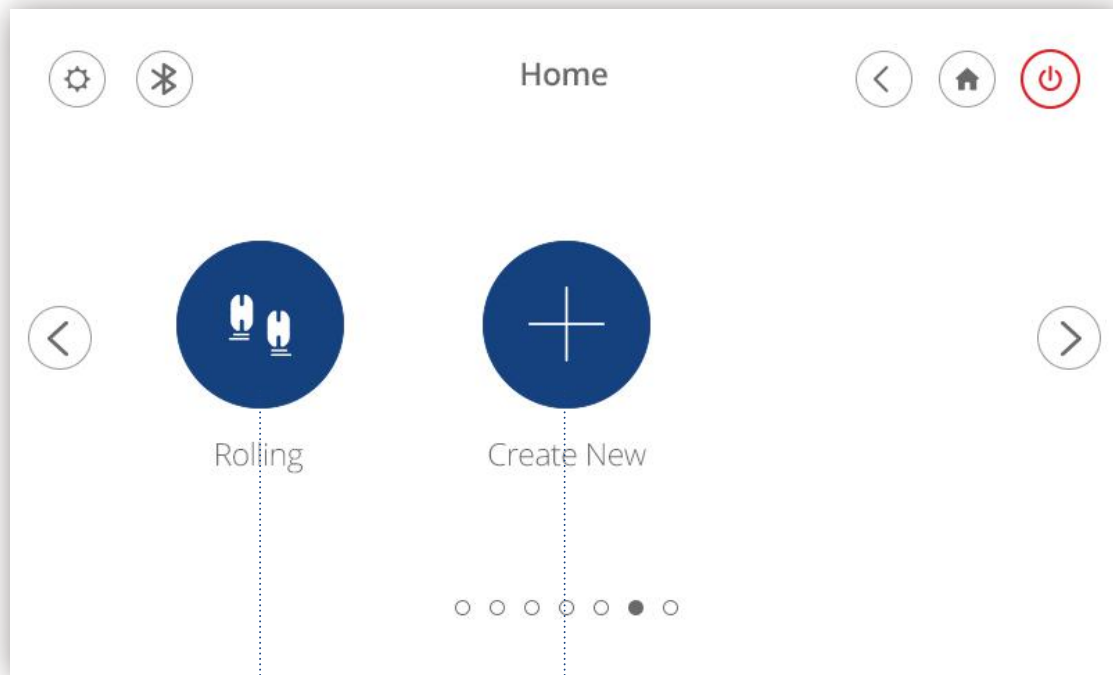

Auto Massage

Create New Program

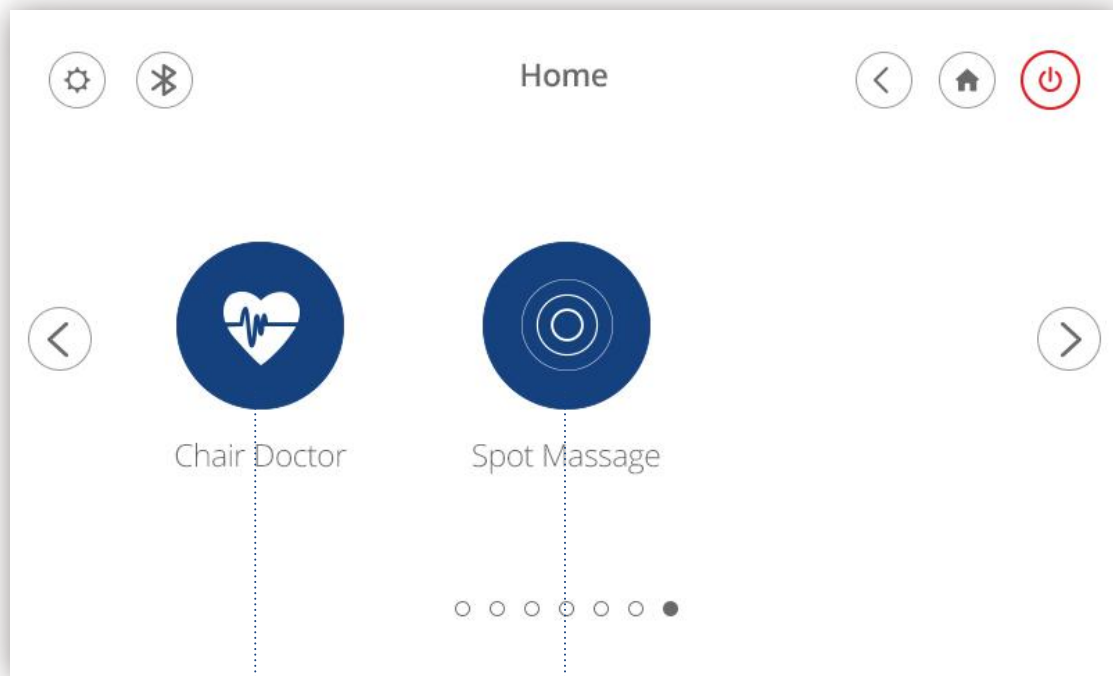

Chair Doctor Program

Spot Massage

Massage Controls

Adjust Strength

Name of Program

Time Left

Rolling min

Full - Body Airbags

4D

4D Depth

Air Intensity

Power

Adjust

Recline

Light

Light Color Variation

Adjust Chair Angle

Select Air Bag Massage Area

Heat

Sole Rollers

Foot Roller

Back Heat/
Seat Heat/
Leg Heat

AUTO MESSAGE

We have designed your chair with multiple massage options for your changing needs. Follow these simple instructions to begin a new auto massage.

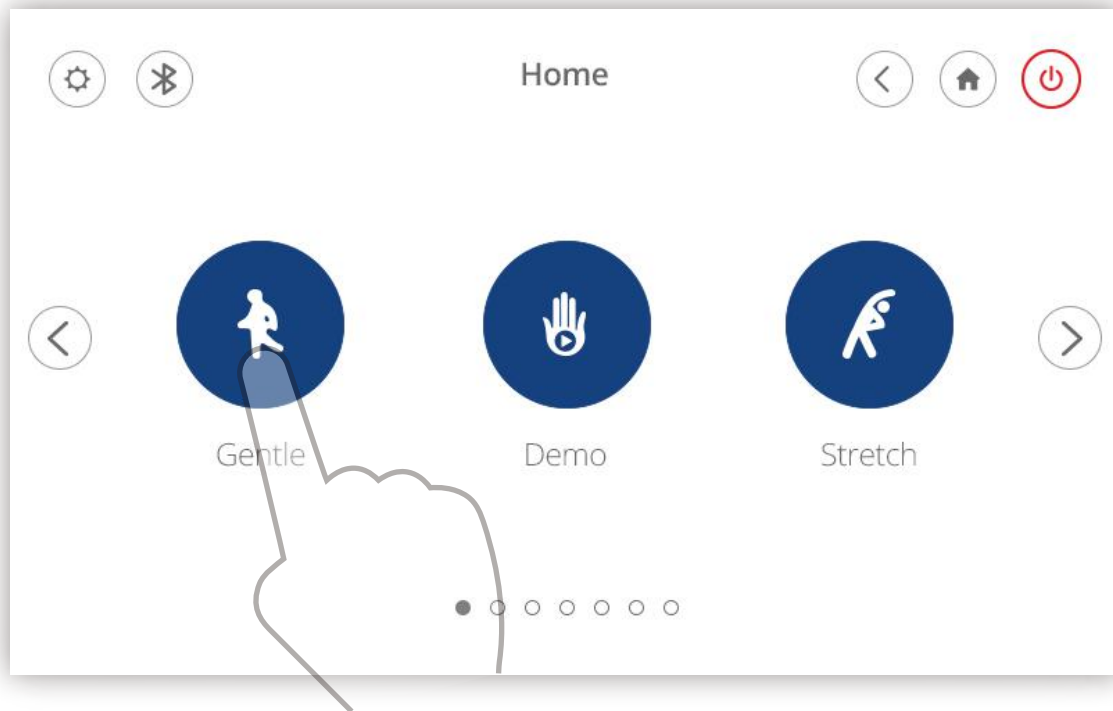

Choose 1 of our 16 auto massages
(Gentle, Demo, Stretch, Recovery, Spine Care, Relax, Vigorous, Swedish, Thai, Japanese, Chinese, Balinese, Upper Back, Lower Body, Legs, Rolling)

Auto Massage Interface

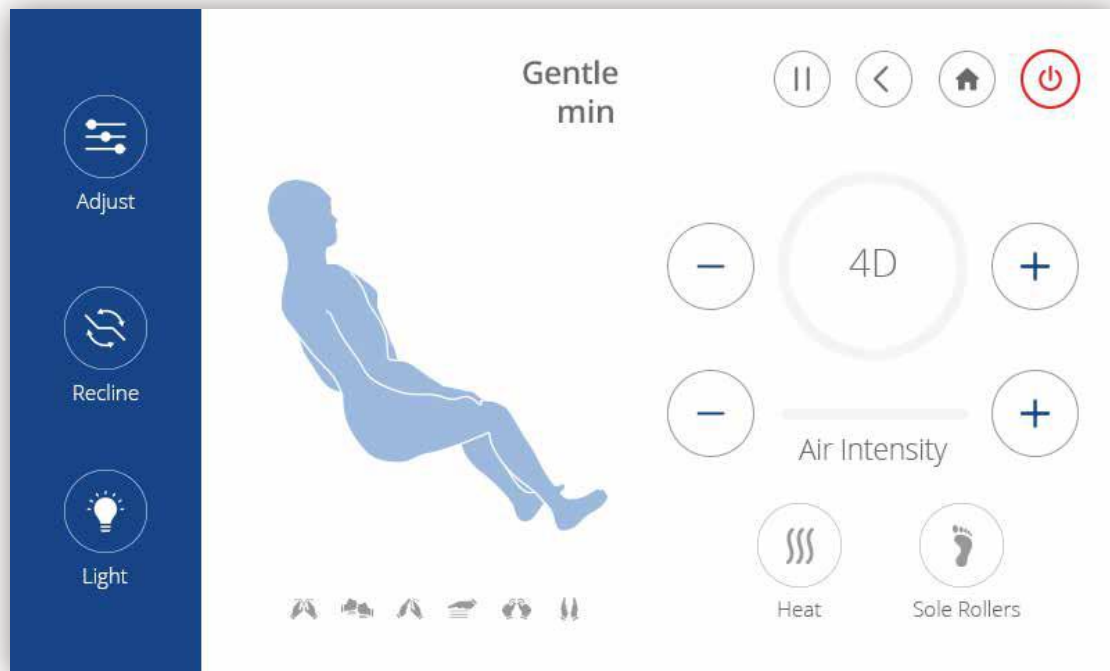

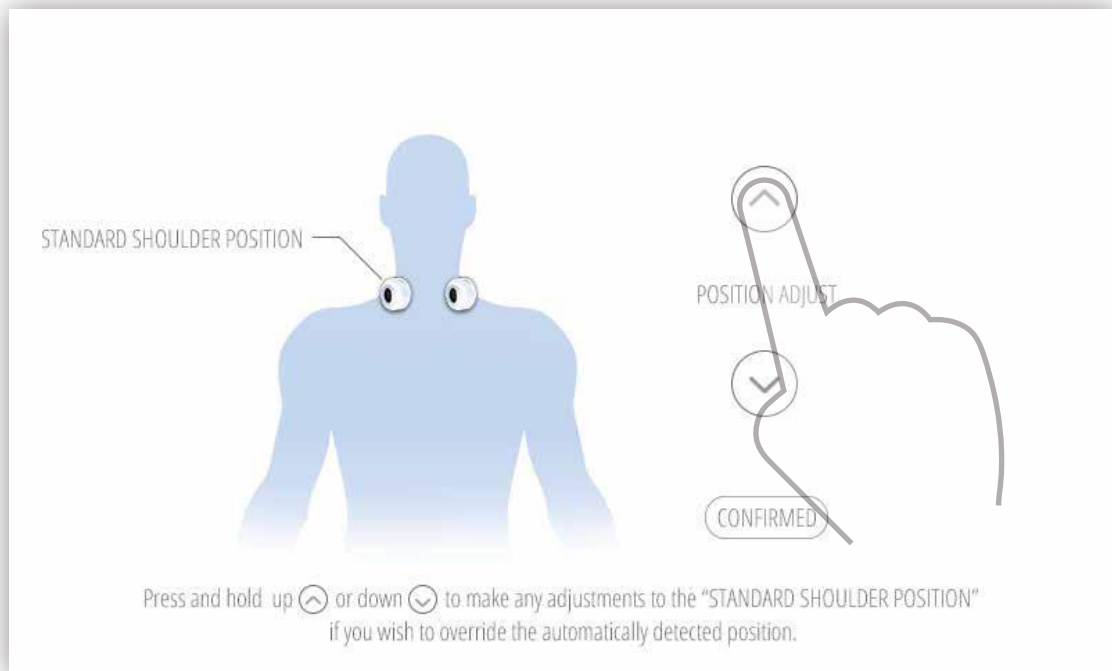

Using the arrows, you can adjust the standard shoulder position

Adjust Massage Strength Interface

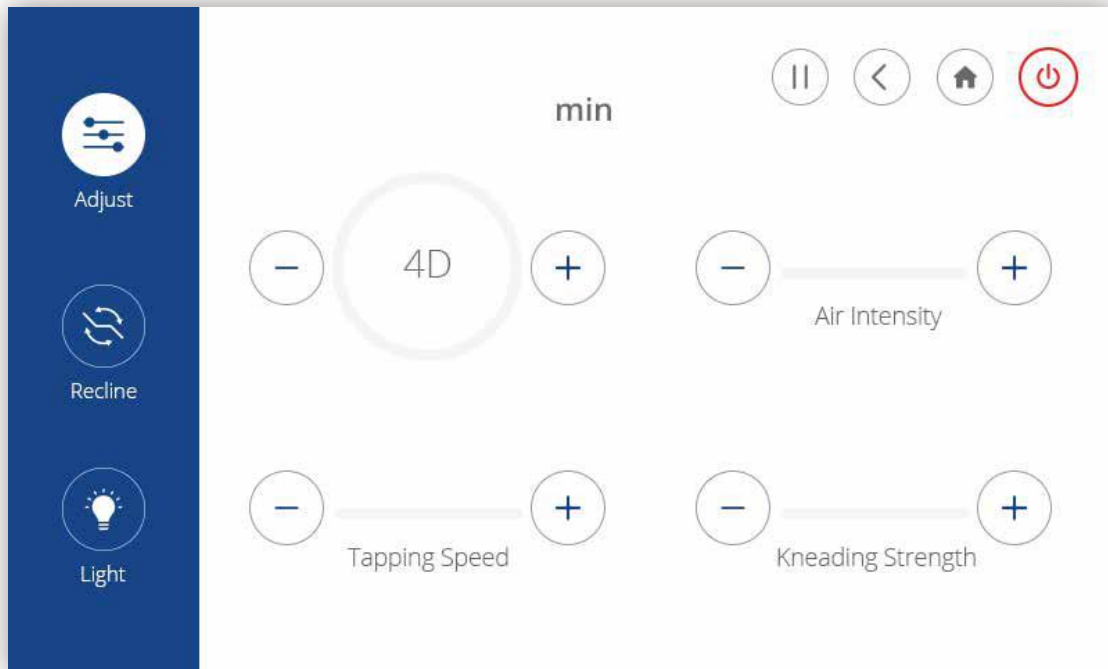

In this interface, you can adjust massage 4D strength, tapping speed, kneading strength and air intensity

Adjust Chair Angle Interface

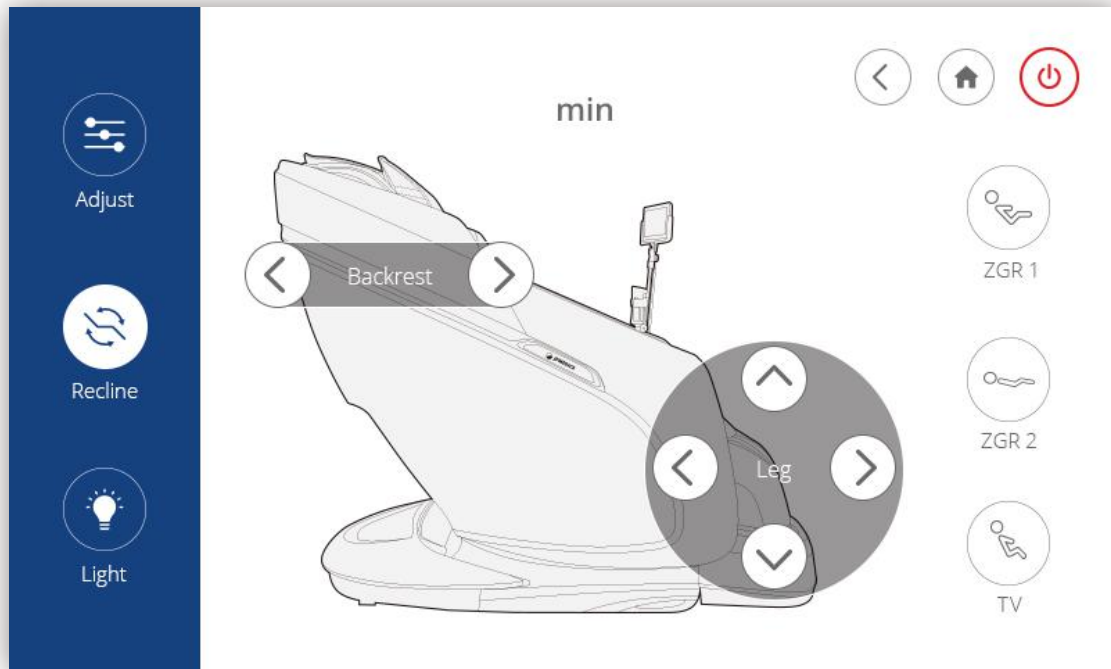

Adjust your chair quickly by choosing one of the three preset seating positions. You can also press and hold the arrows to adjust parts of the chair independently

Change the Light Interface

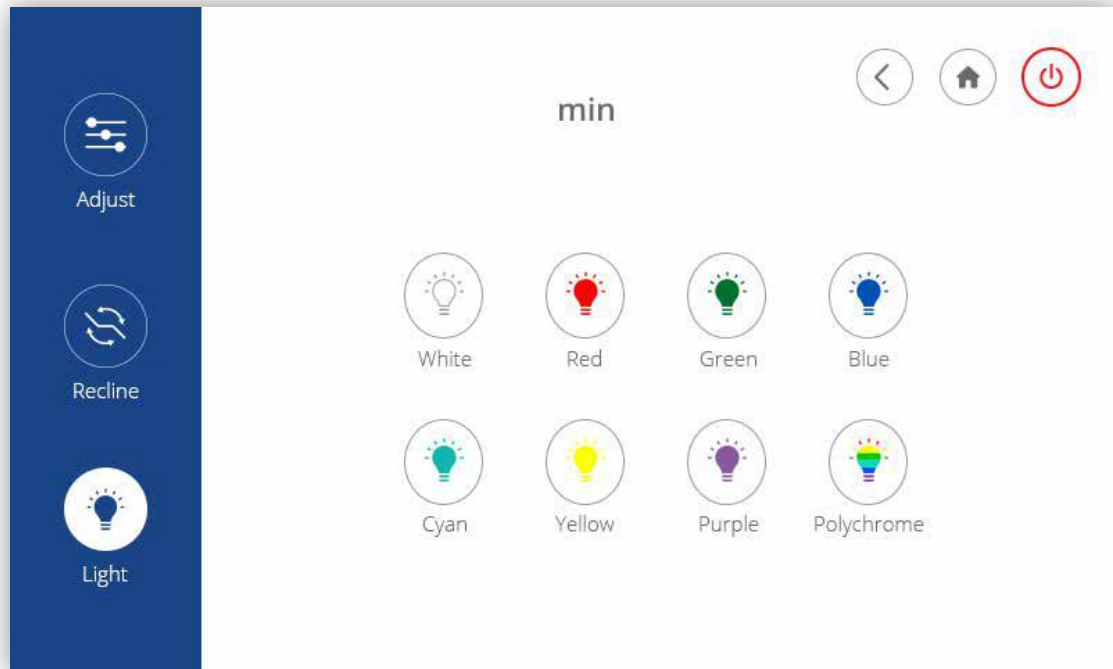

Choose 1 of the 8 types of LED light patterns

DEMO

In order to allow you to quickly understand the many features of this massage chair, we have created a demo mode for you.

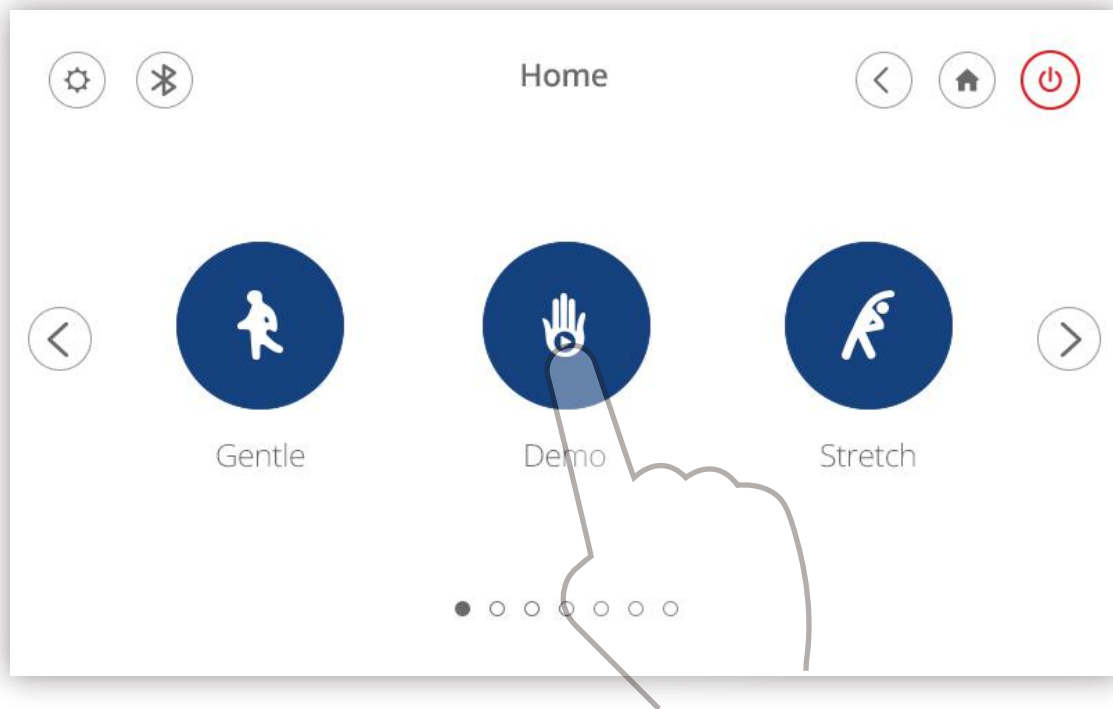

Choose the "Demo" icon to begin the demo program

Demo Interface



CUSTOM MESSAGE

Every body is different. That's why we've given you the option to customize your message to meet your specific needs. Follow these simple instructions to create a new custom message. You can create up to 3 custom programs. To delete a custom message program, press and hold the icon of the message you want to delete and choose the "x".

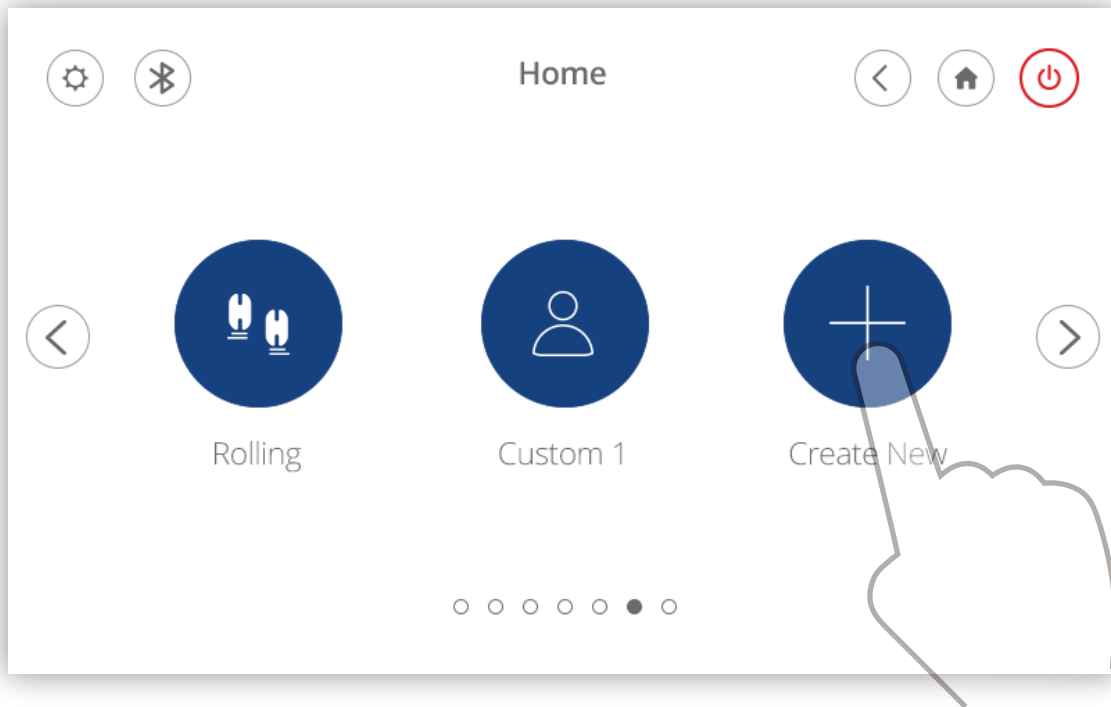

Choose the "Create New" icon to begin creating your message program

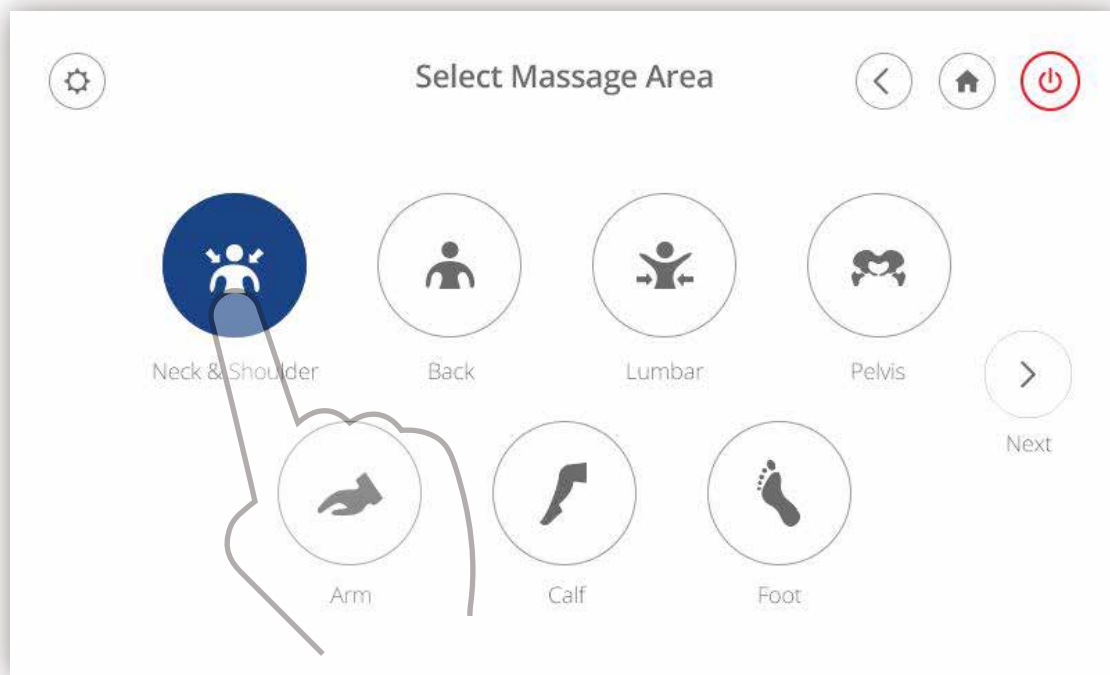

Select the massage area that you prefer

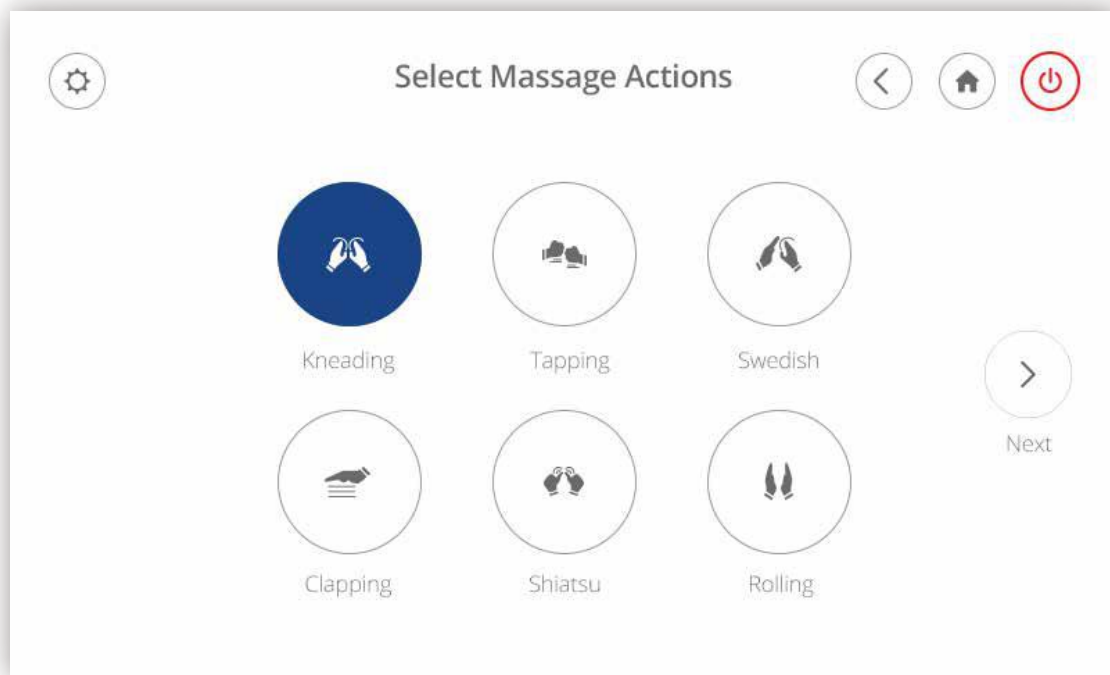

Select your favorite massage actions. The knead, tap, clap, and shiatsu massages can be combined with swedish or roll

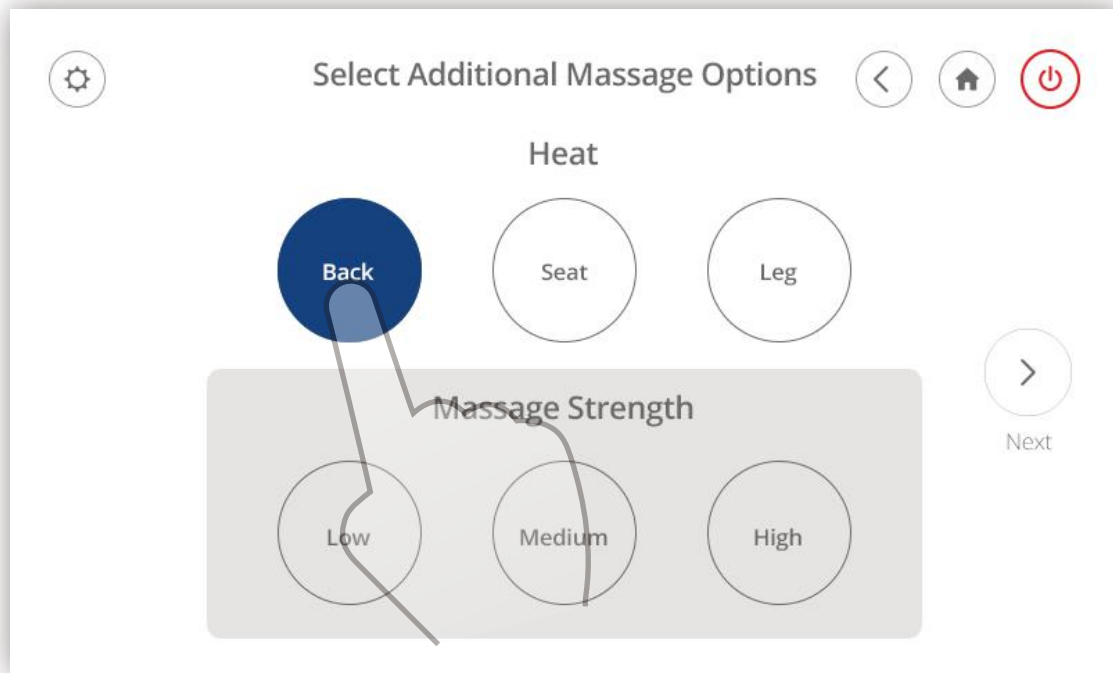

Select the heat area and massage strength that you prefer

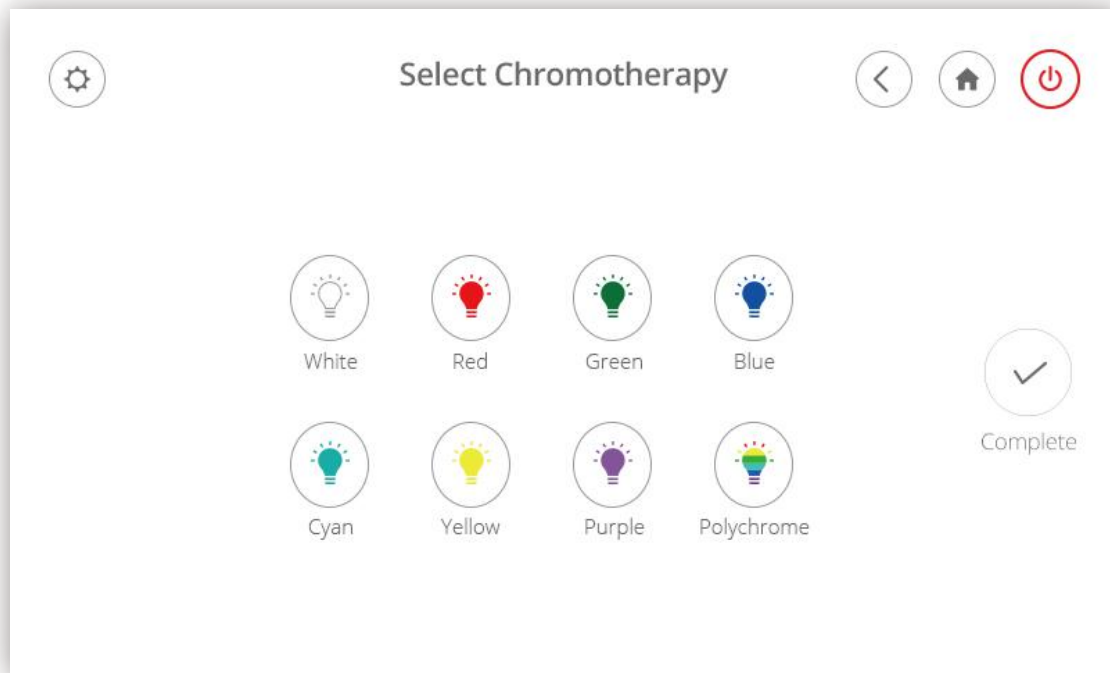

Select the chromotherapy light pattern that you prefer

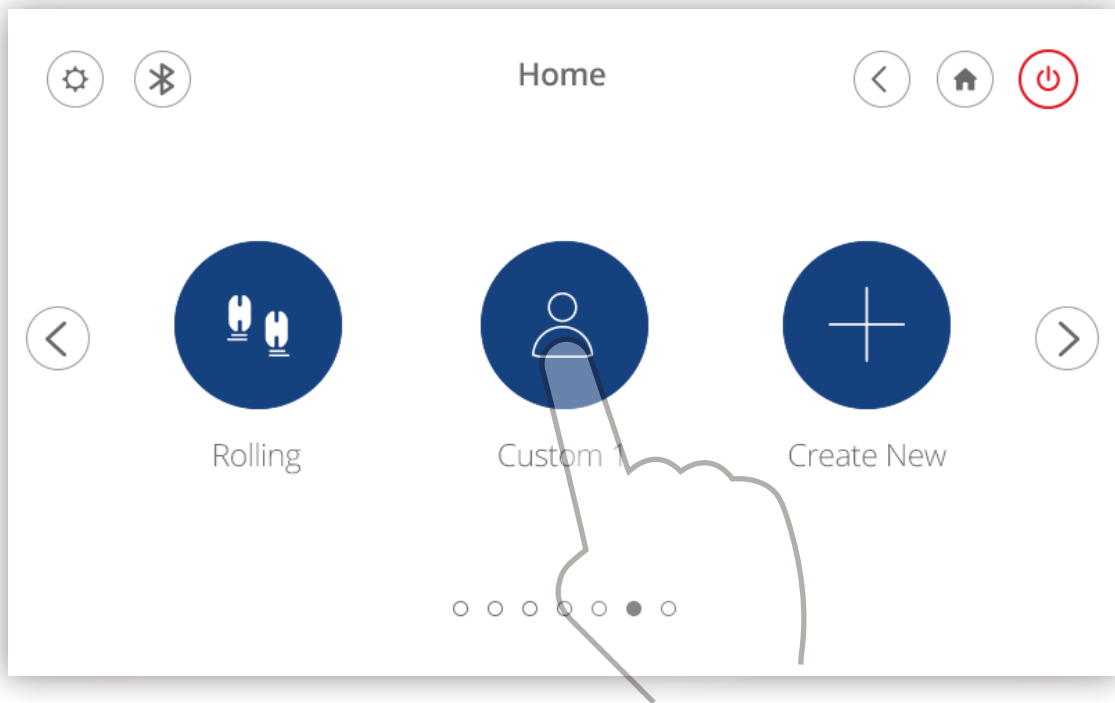

Choose the "Custom 1" icon to start your program

Custom Interface



SPOT MESSAGE

This is a fixed message area and actions program.

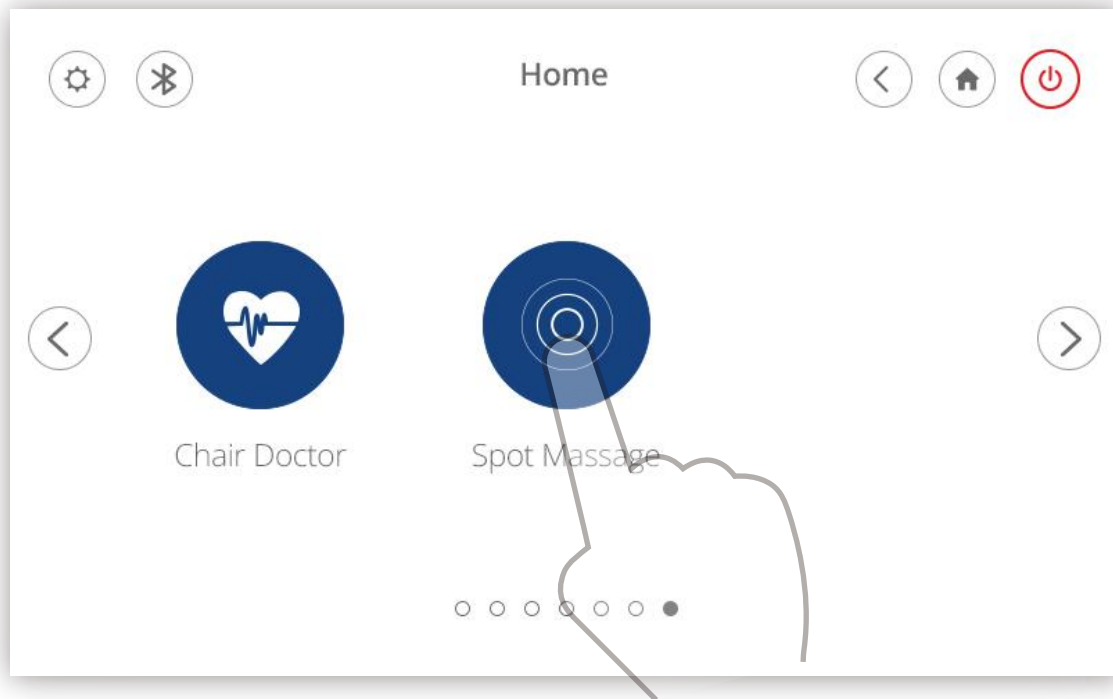

Choose the "Spot Message" button to take you to the spot message page

Spot Massage Interface 1

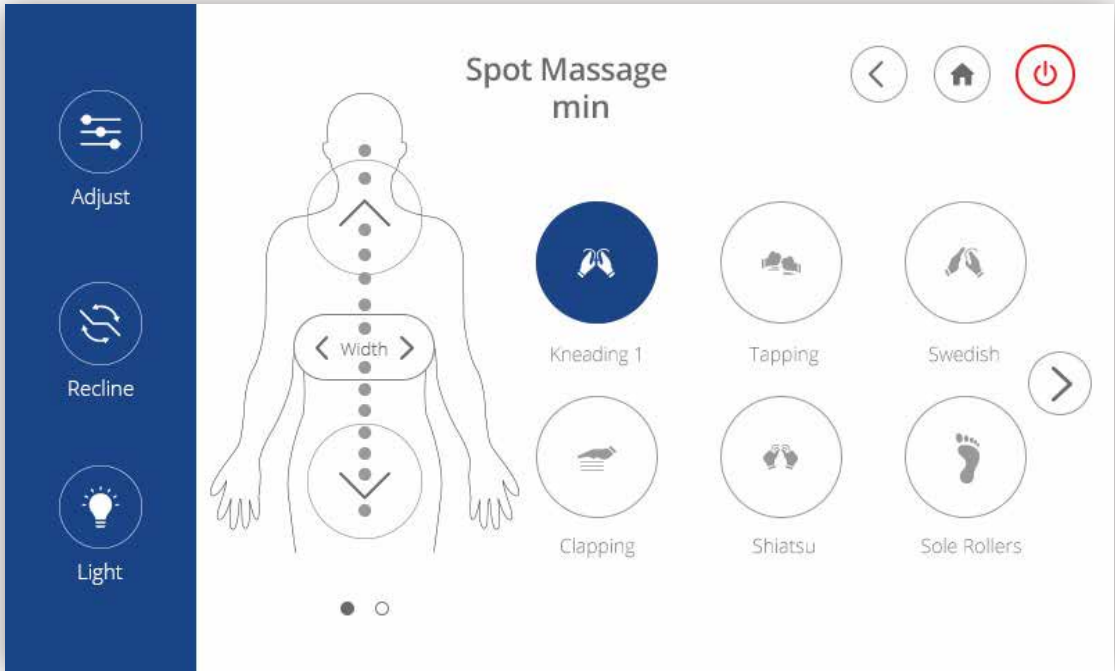

Spot Massage Interface 2



CHAIR DOCTOR

An innovative biometric scanner that diagnoses your body tension, SpO2 (oxygen saturation), and heart rate, to treat your unique body.

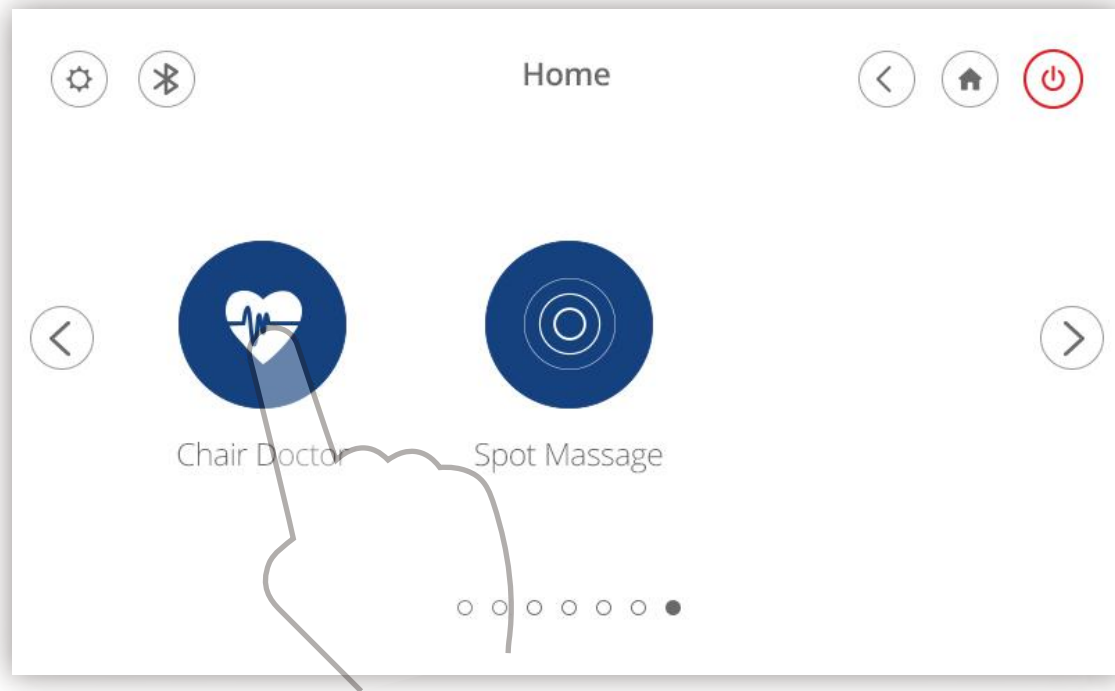

Choose the "Chair Doctor" button to take you to the chair doctor program page

Chair Doctor Interface 1

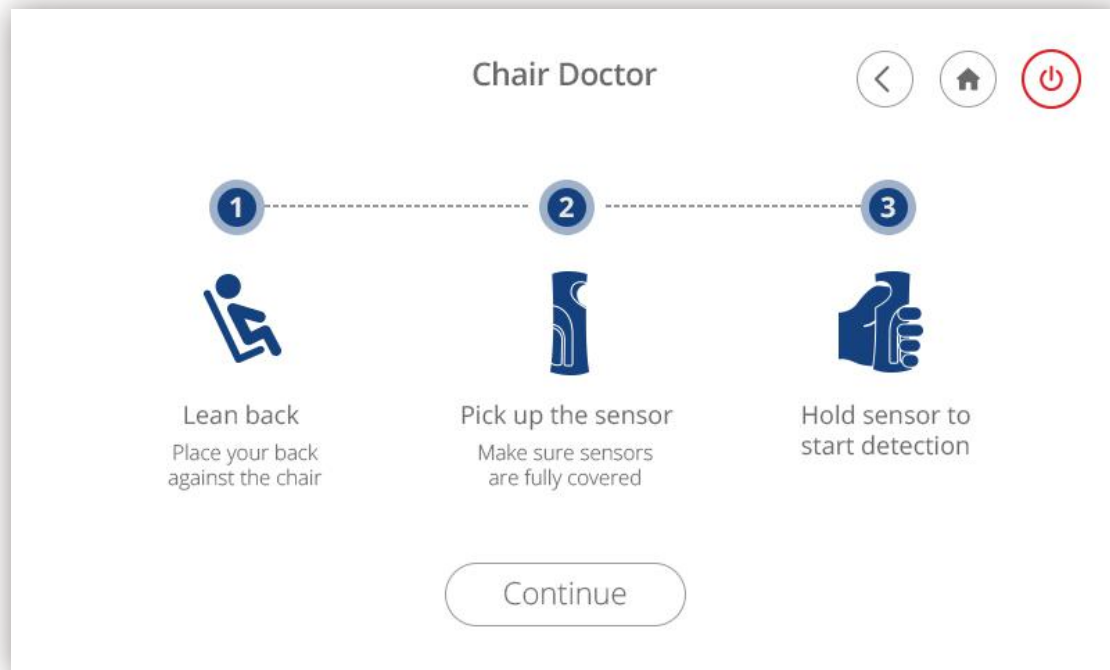

Chair Doctor Interface 2

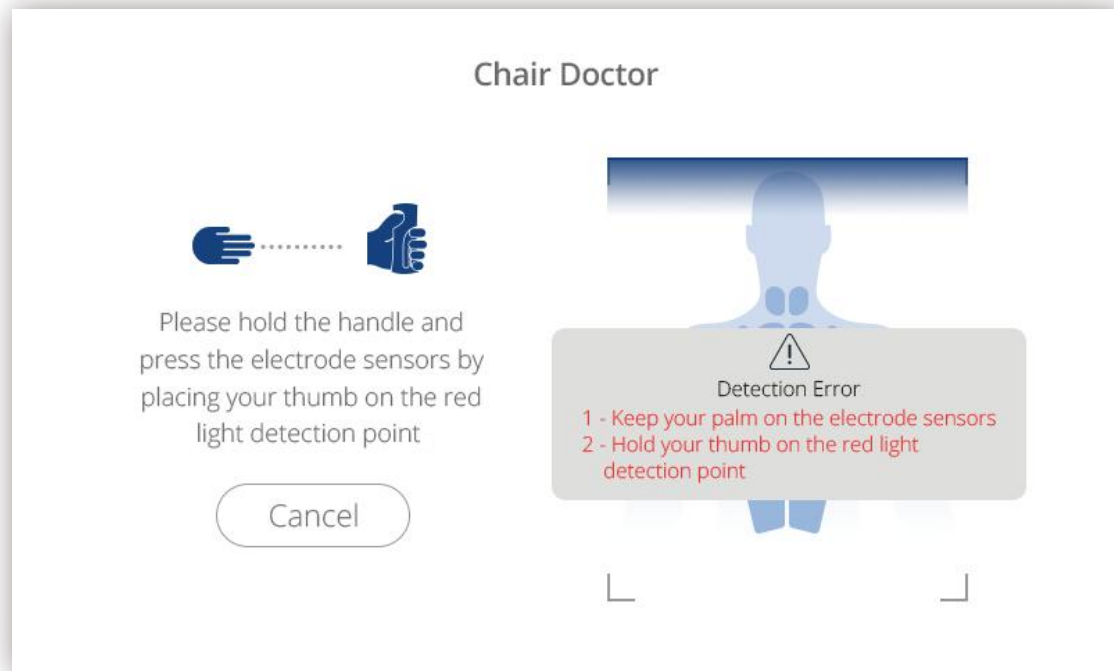

Hold the handle correctly, otherwise there will be a corresponding page reminder

Chair Doctor Interface 3

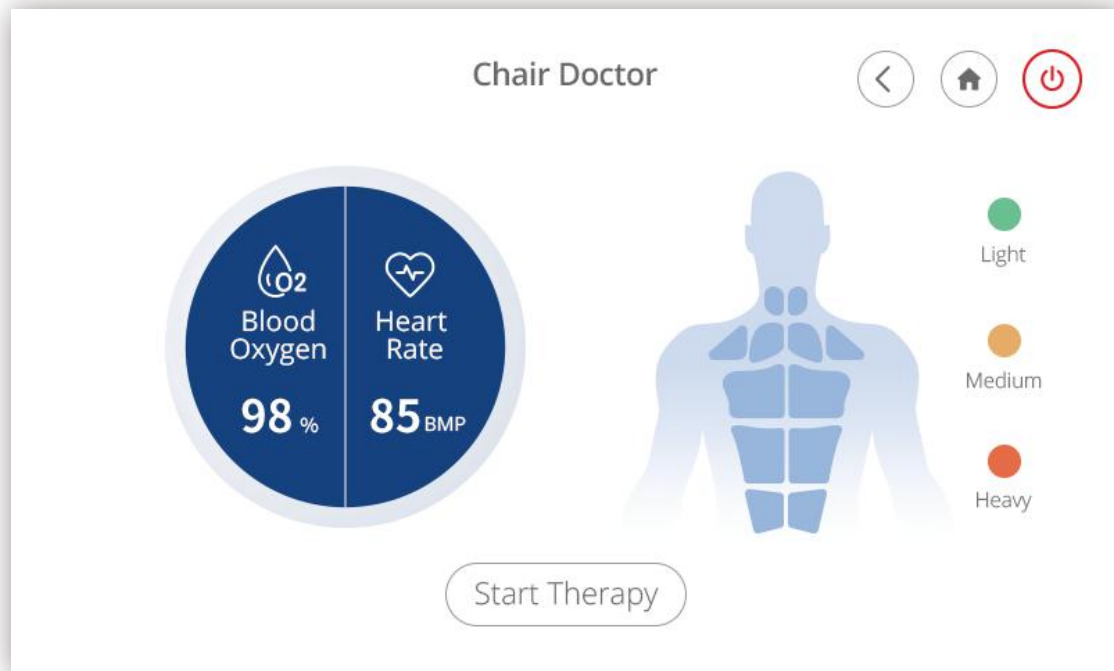

SETTINGS

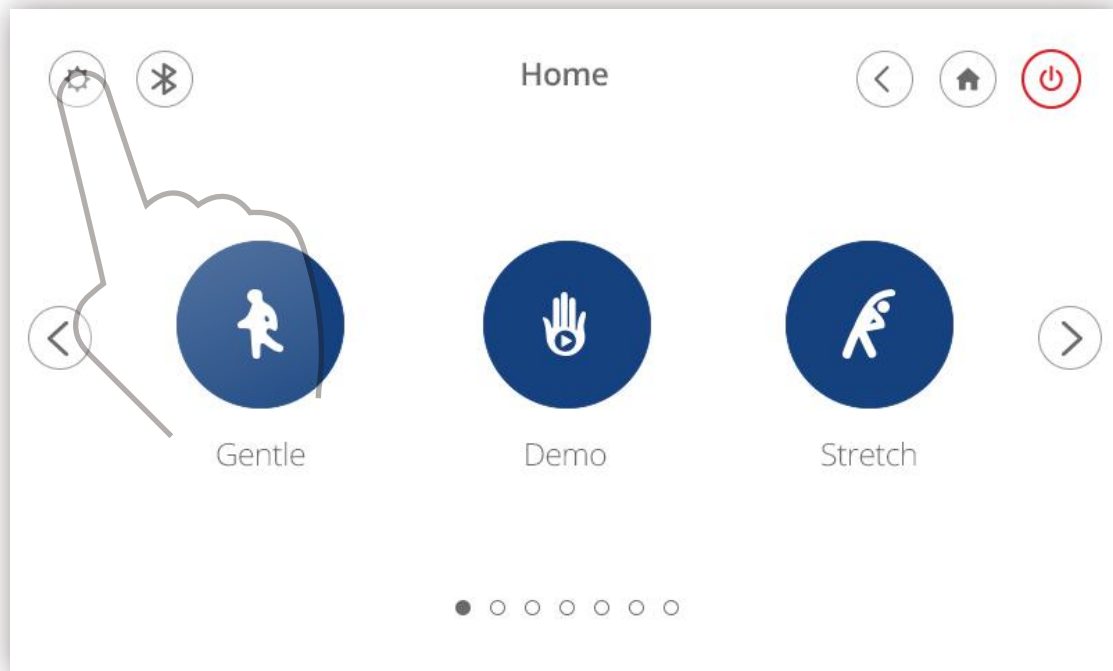

Choose the "Settings" button to take you to the settings page

Settings Interface

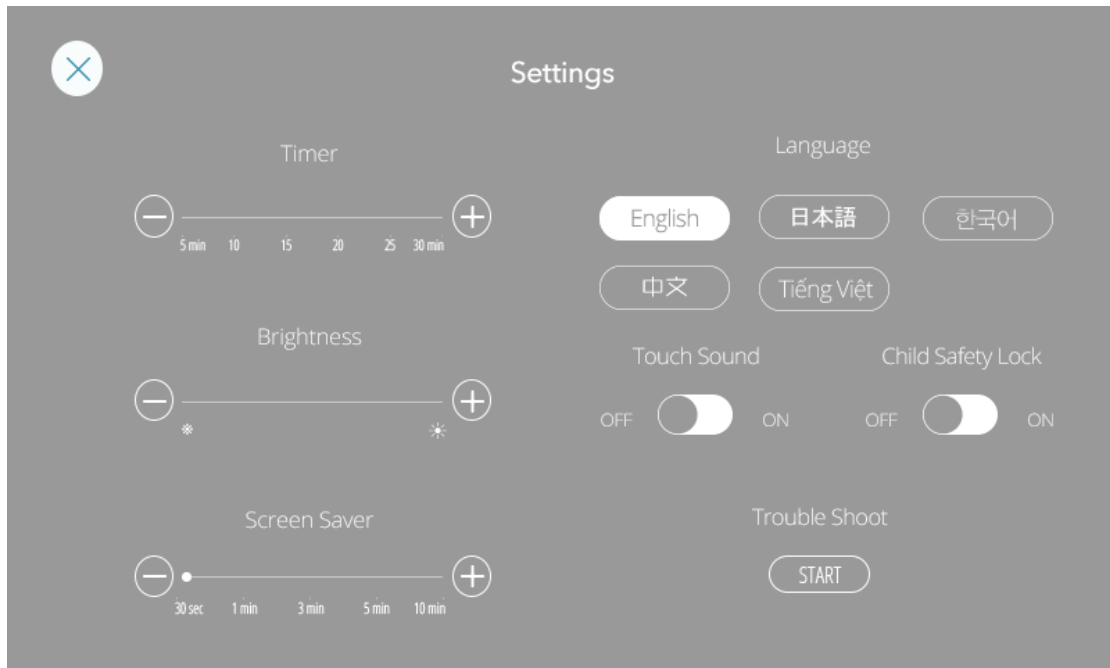

Child Safety Lock

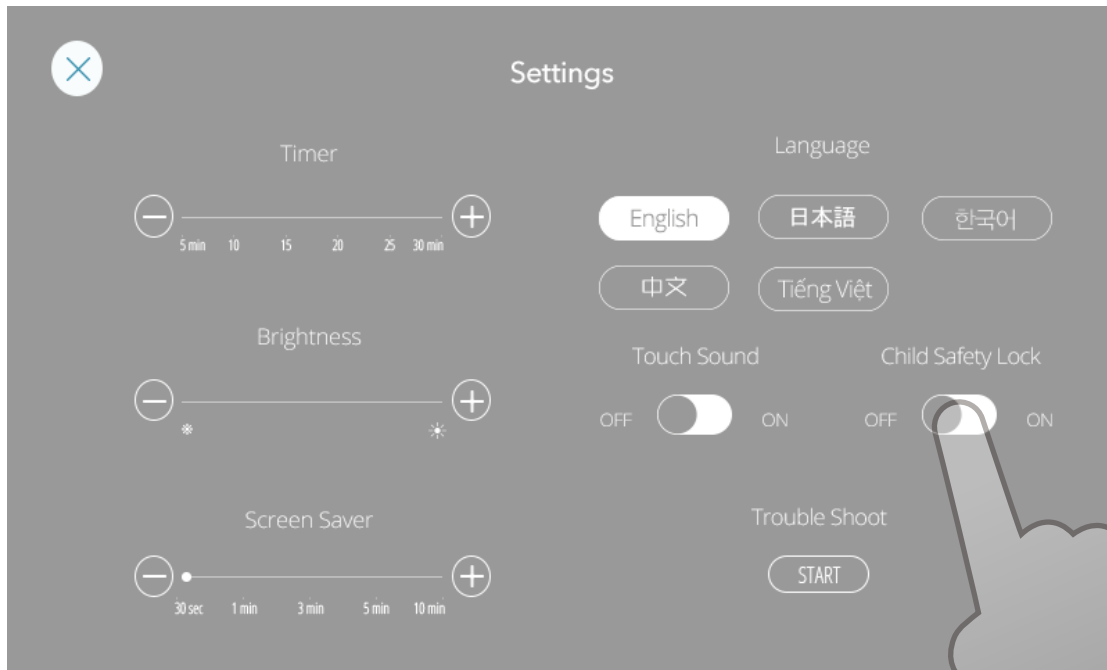

To disable this chair for child safety, set the Child Safety Lock setting to "ON"



When the child safety lock is on, the massage chair will be turned off and reset.
All functions will be disabled. Please enter pin code "0304" to unlock

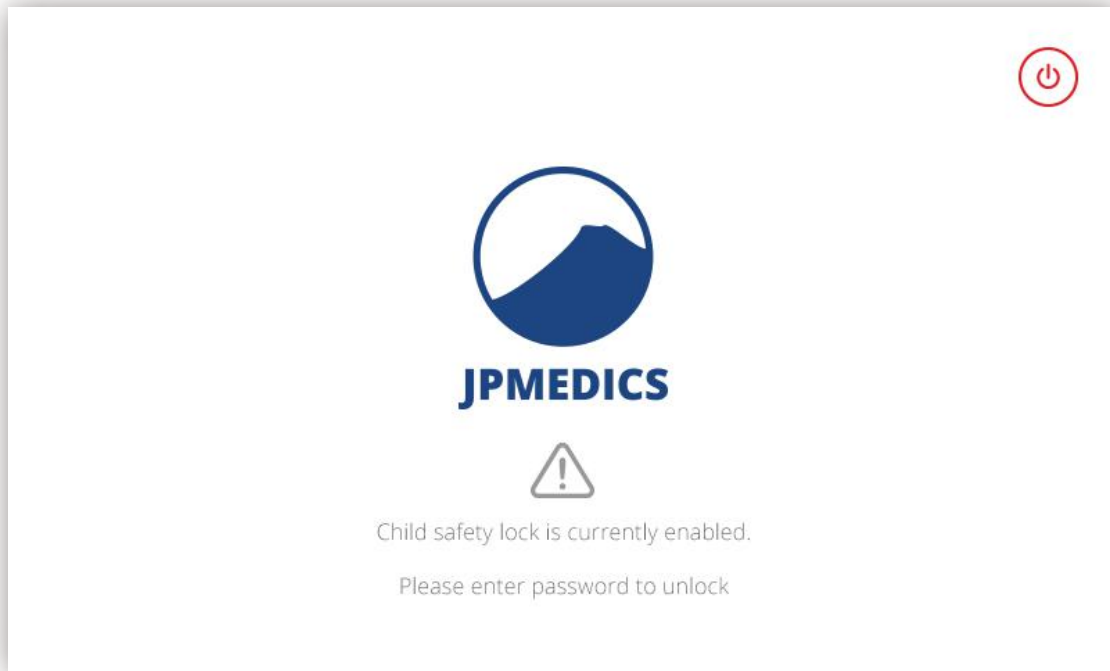

When the child safety lock is enabled, this screen will appear at startup.
Please click anywhere on the screen to begin the unlocking process

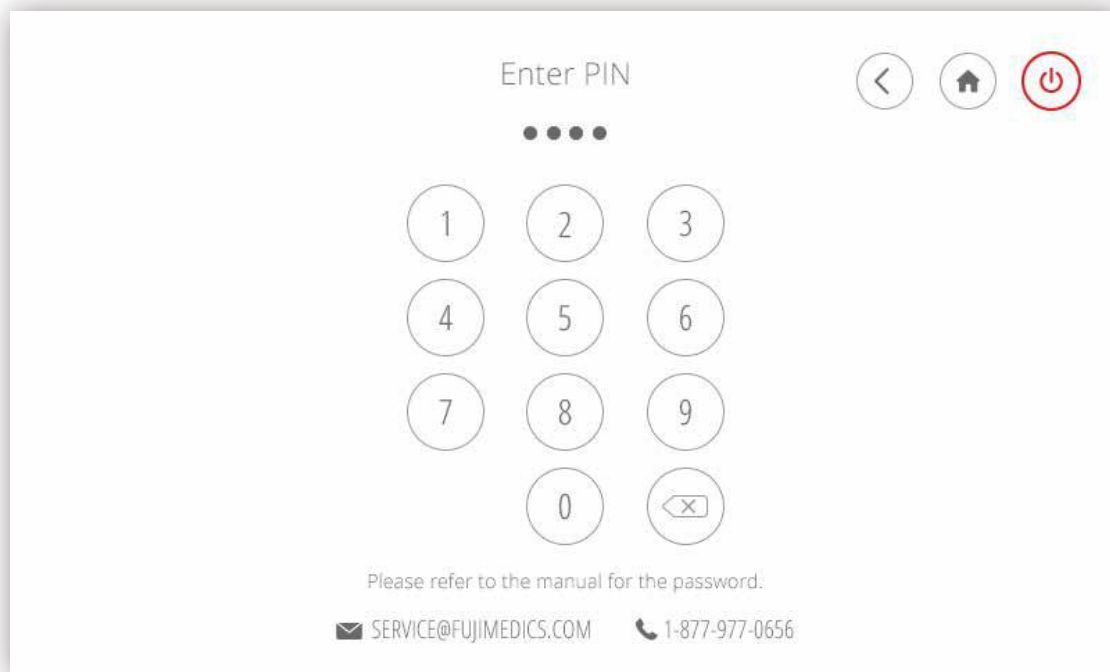

Please enter "0304" to unlock your massage chair

Trouble Shooting



If your chair has any trouble, press the Trouble Shoot "Start" button for the chair to automatically detect problem areas. Use the error code provided when contacting our customer service team



Choose "Start" button and make sure the chair is not occupied during chair detection

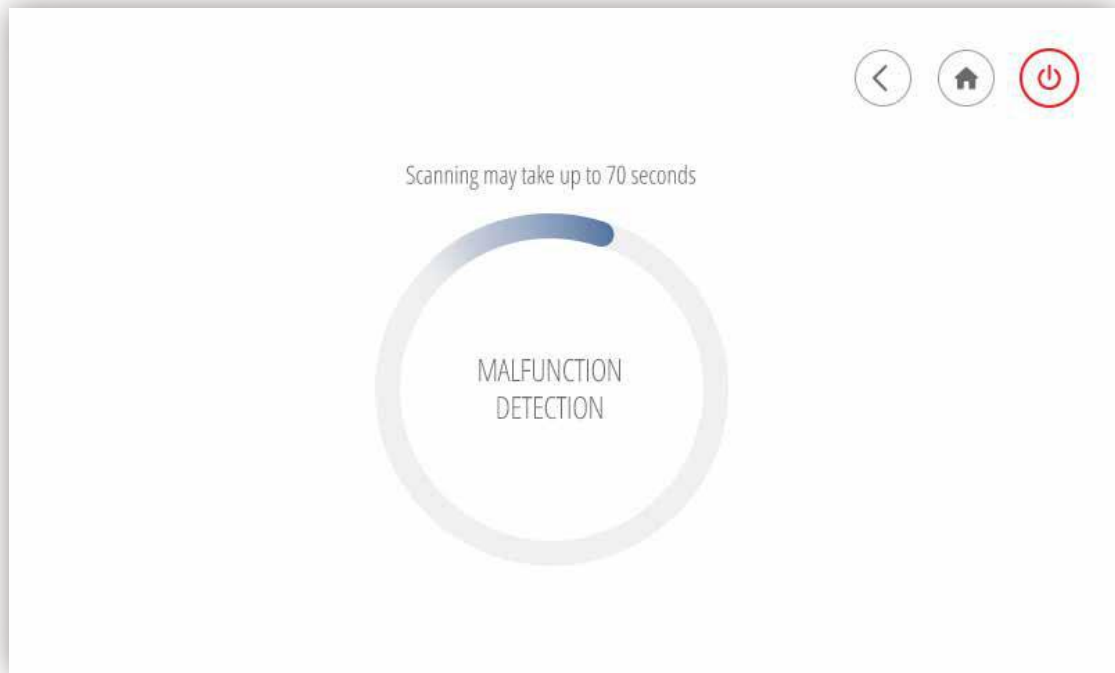

Your chair is detecting possible malfunctions, please wait for the detection result



You can use your detection code when contacting the customer service team about your chair's problems

Safety Reminder



Warning



An object was detected around the leg area of your chair. Check if there is a blockage, and if not press the OK button. After pressing the button choose a massage program.

OK

APPLICATION INTERFACE

Please go to the Google Play or Apple App Store to download our app. You can search for "JPMEDICS " to find it.
Note: Application may be upgraded periodically for a better experience, some text and pictures below may not be the same as your version of the app.

Chair Connecting

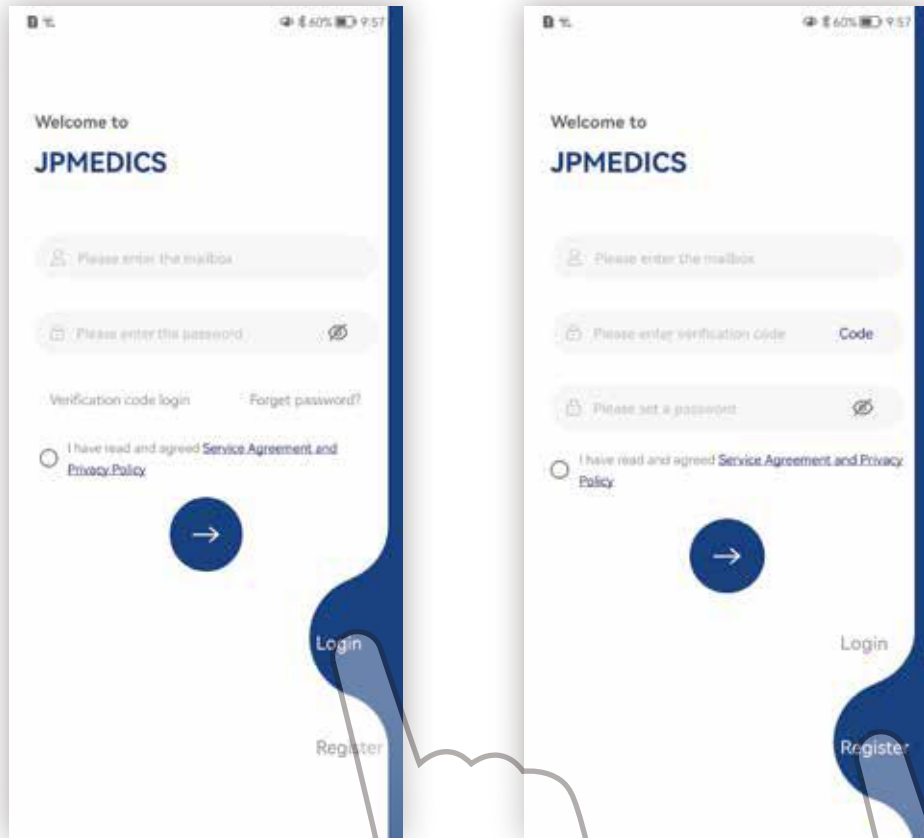

Here you can log in to a registered account. If you do not have an account, please register first

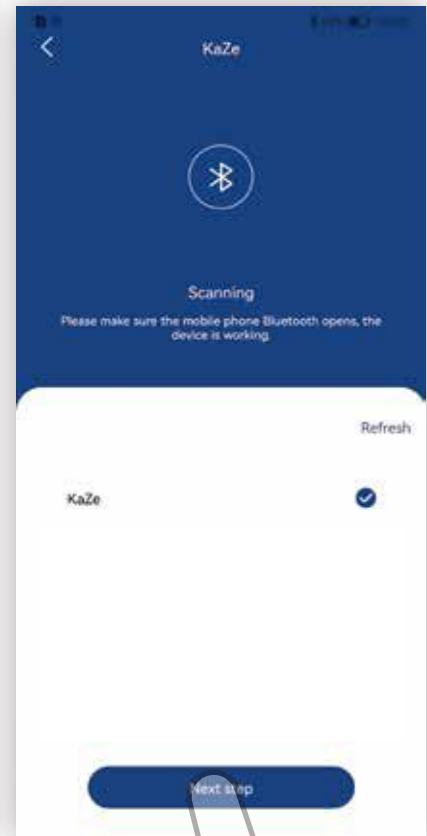
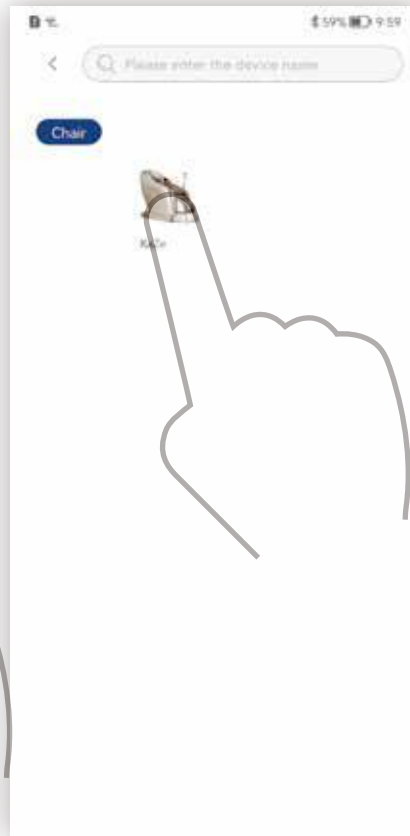

Make sure your smart device's bluetooth is turned on, then click "add a device" to connect your device to your chair

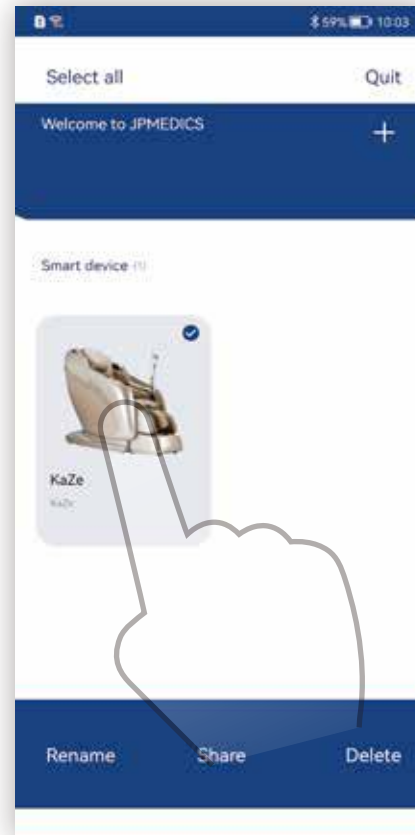

You can name your chair or edit the name with a long press of the icon

Voice Control

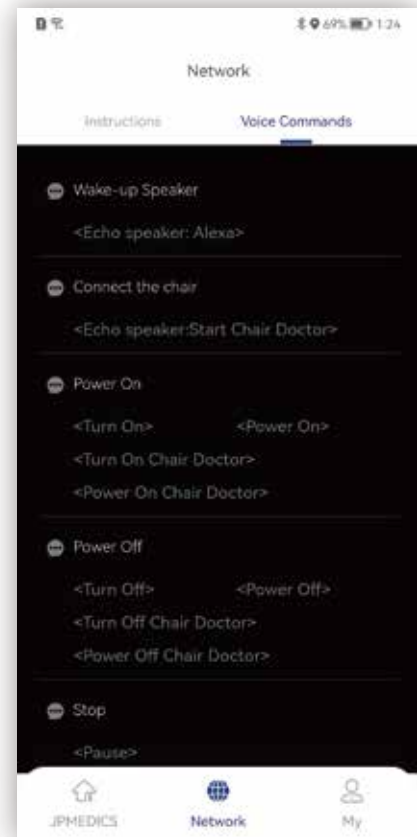
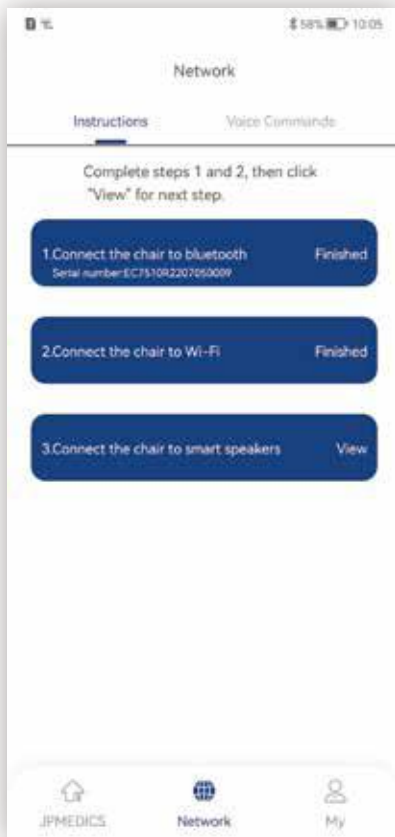

This chair supports Alexa smart speakers (please purchase speakers from Amazon).
Follow the above steps to connect to a smart speaker

Home Screen

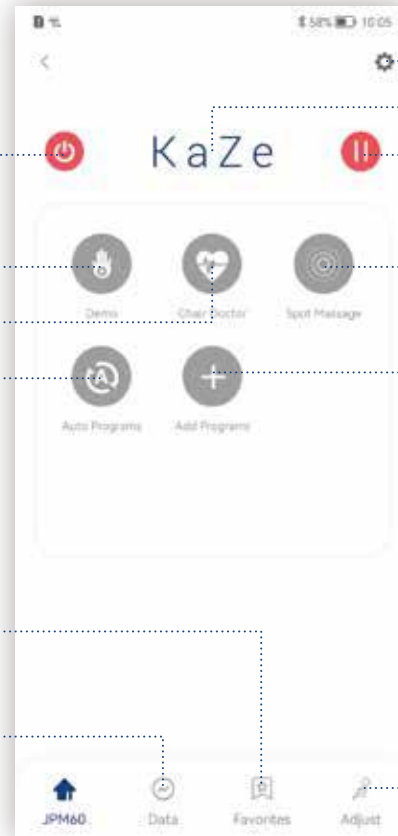

- Settings
- Name of Chair
- Pause
- Power
- Demo
- Chair Doctor
- Auto Massage
- Spot Massage
- Add Programs
- Favorites program
- Health & Message Data
- Adjust Chair Angle

Click the power icon to turn on your chair

Auto Massage Interface

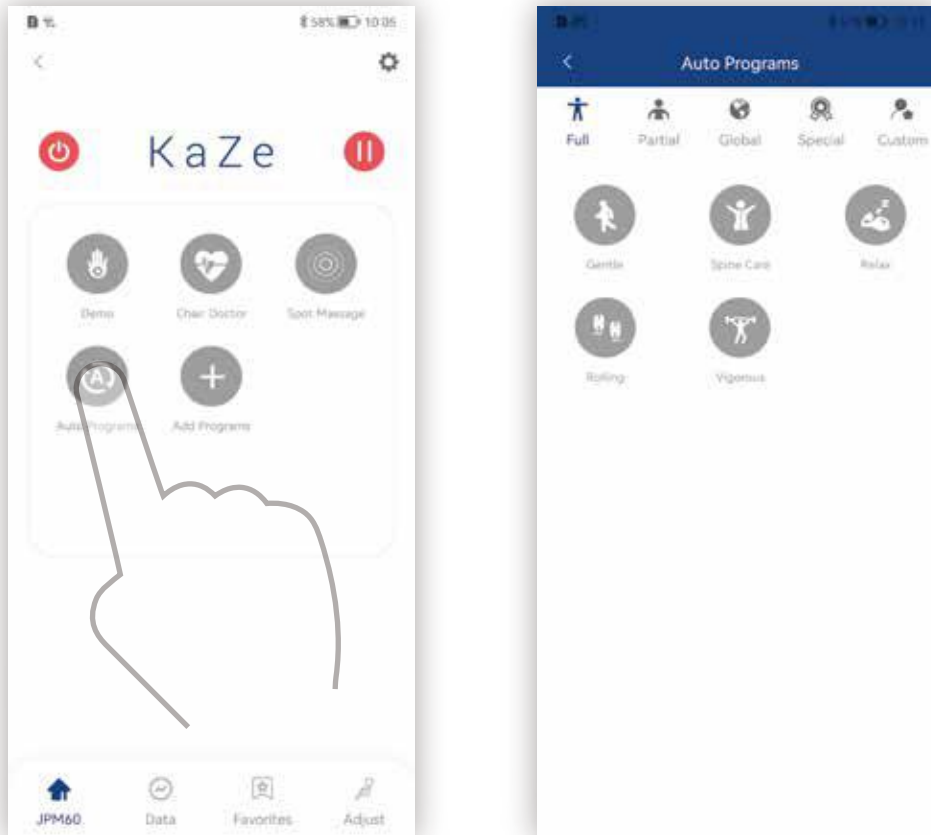

Click this icon to go into the auto program interface, then select your preferred auto program

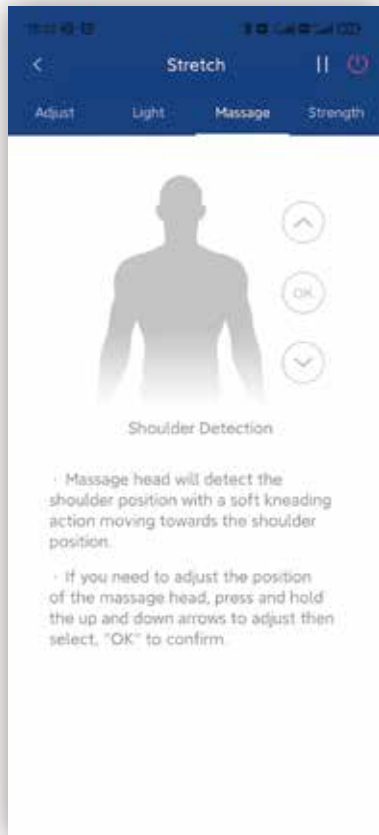

Using the arrows, you can adjust the standard shoulder position



Adjust your chair quickly by choosing one of the three preset seating positions. You can also press and hold the arrows to adjust parts of the chair independently

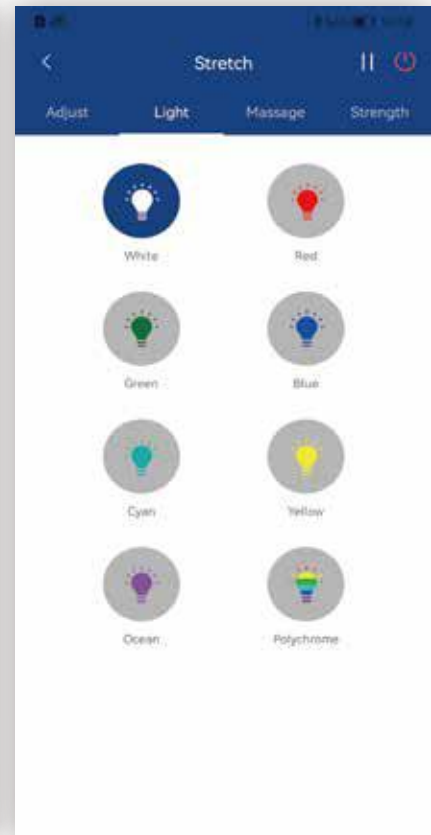

Choose 1 of the 7 types of LED light patterns

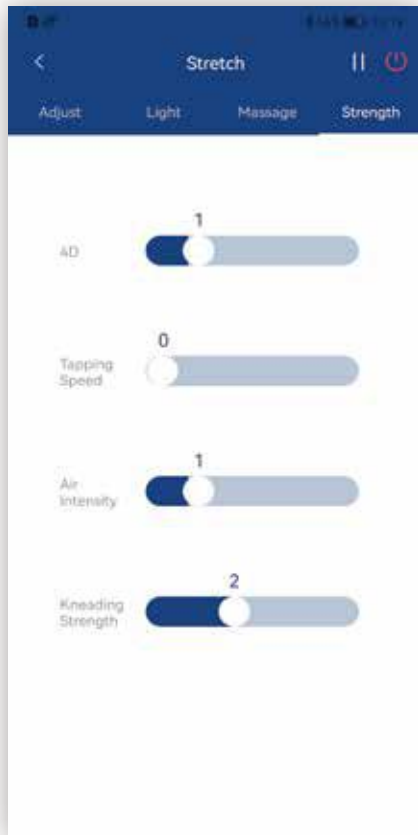

In this interface, you can adjust massage 4D strength, tapping speed, kneading strength and air intensity

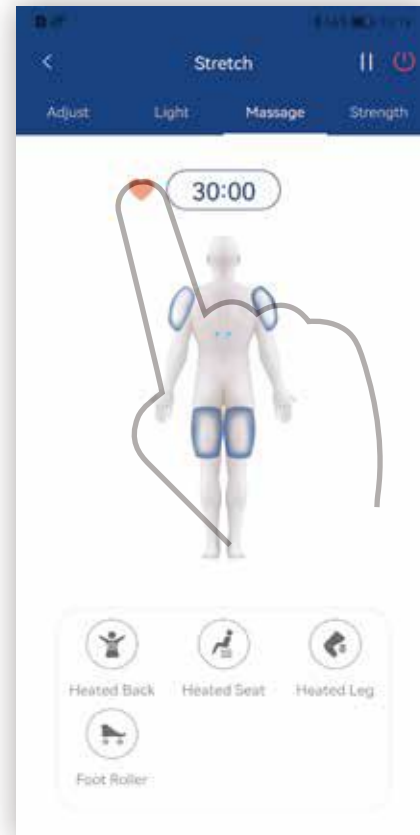

Click the icon to save your preferred auto massages into your favorites

Adding Programs Interface

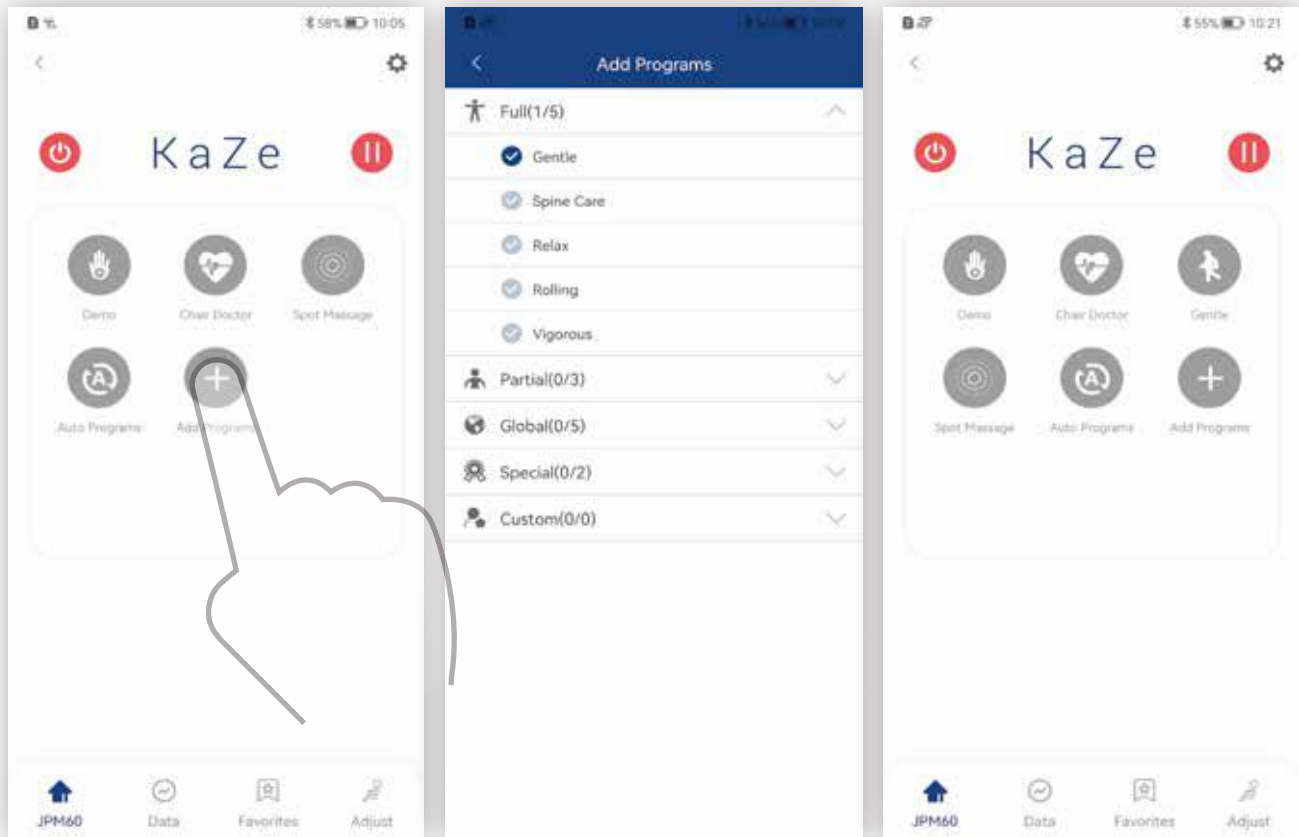

Choose your preferred auto program messages to add to the home page

Chair Doctor

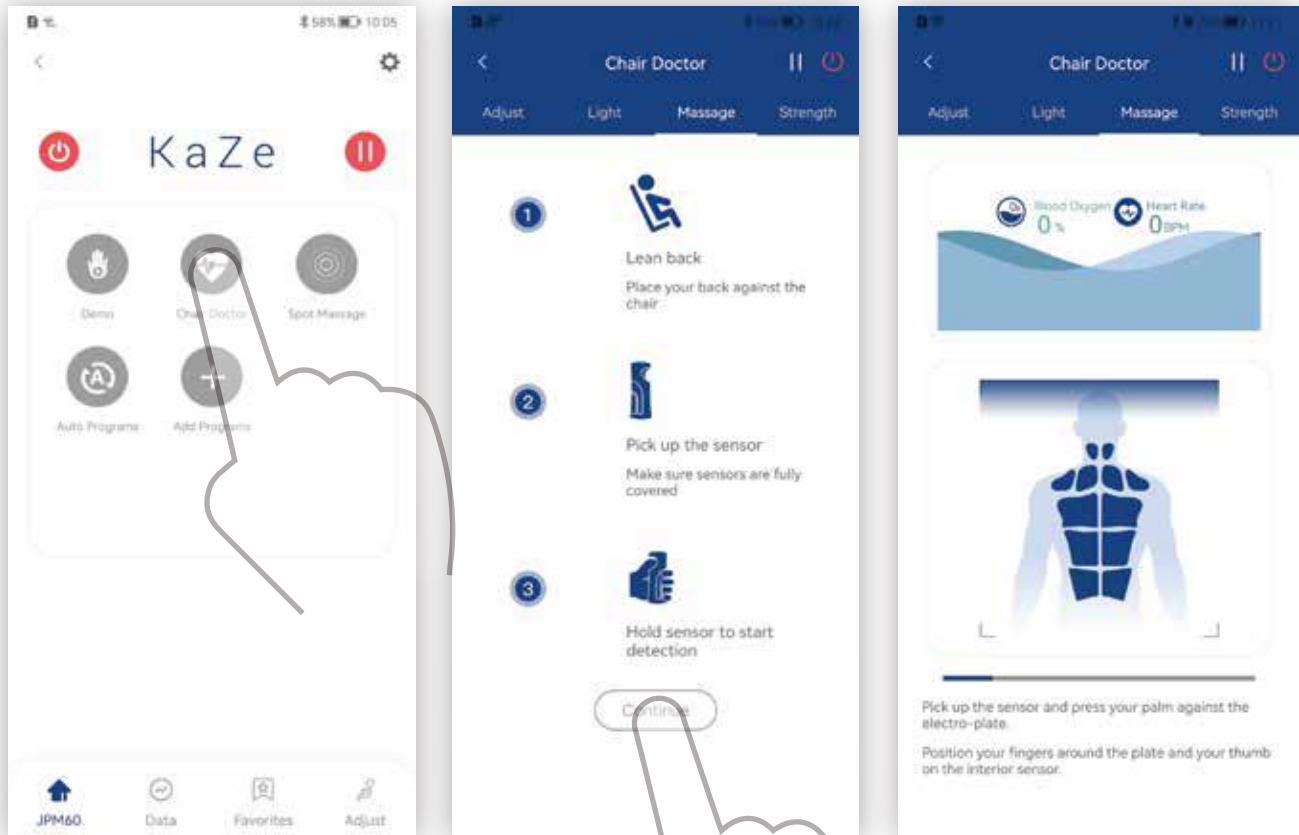

Follow these simple instructions to begin a new diagnosis



After diagnosis, the chair doctor will generate a course of treatment that best suits your needs. Select "Start Therapy" to begin the specially crafted massage

Spot Massage

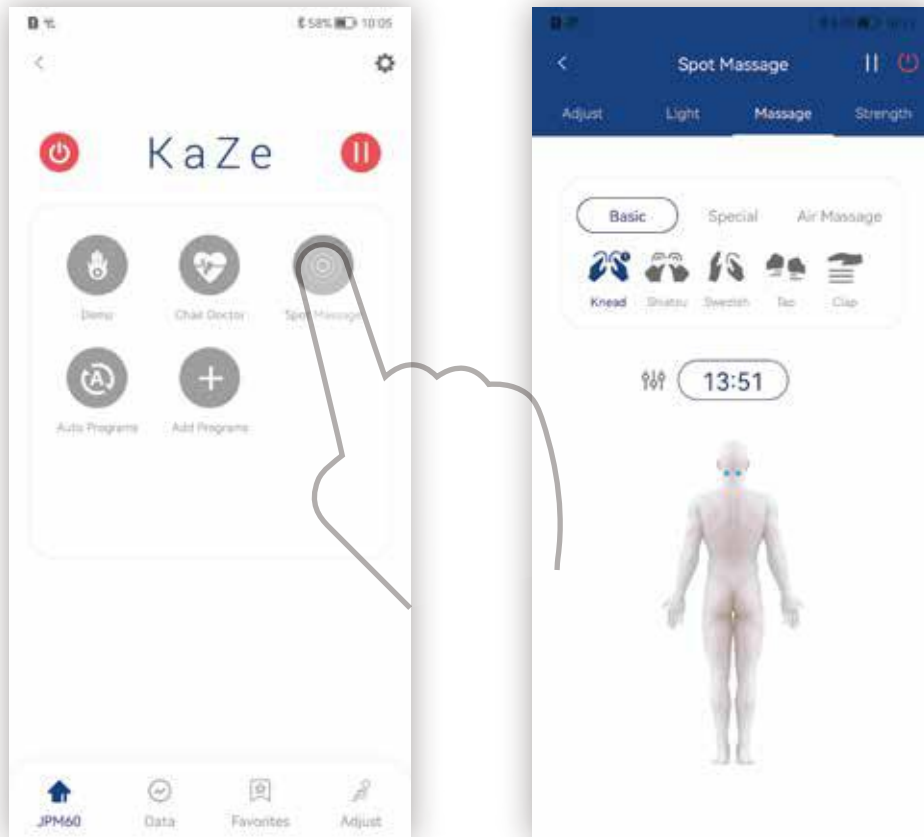

Click the "Spot Massage" button to take you to the spot massage page

Custom Message

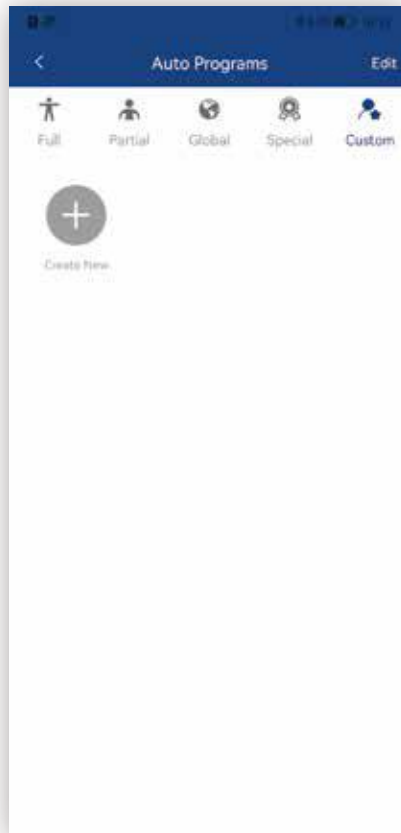

Choose the "Create New" icon to begin creating your message program

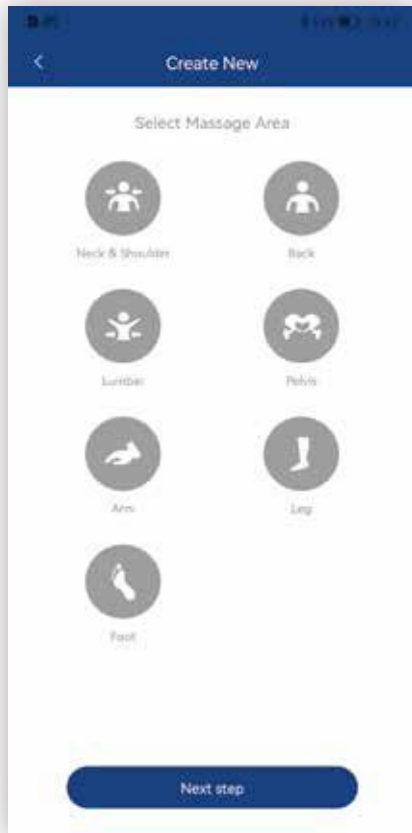

Select the massage area that you prefer

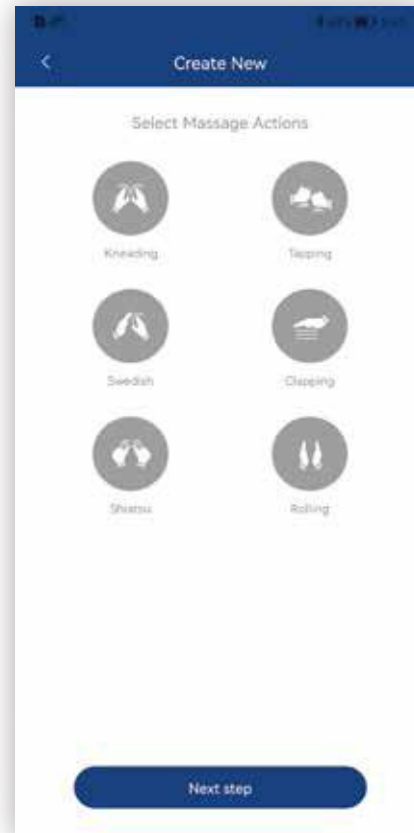

Select your favorite massage actions.
The knead, tap, clap, and shiatsu
massages can be combined with
swedish or roll

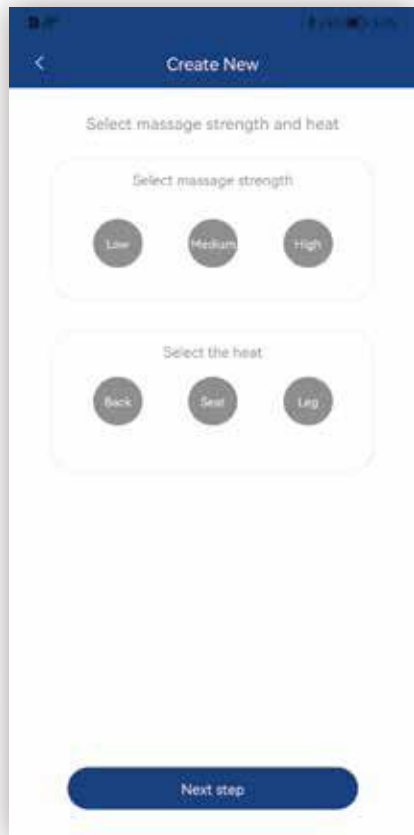

Select the heat area and massage strength that you prefer

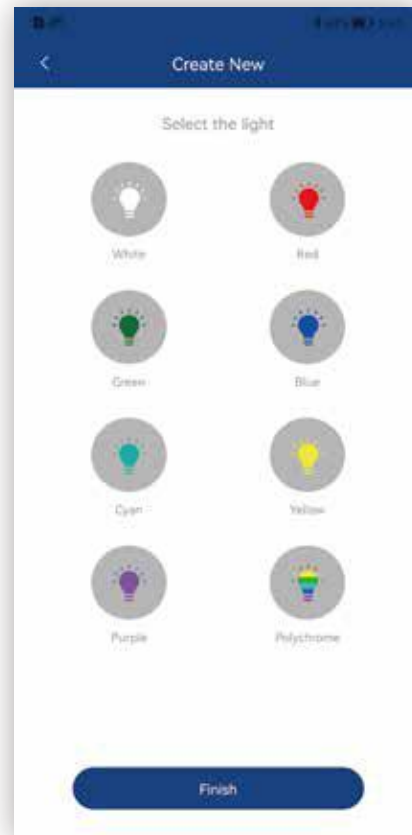

Select the chromotherapy light pattern that your prefer

Custom Interface

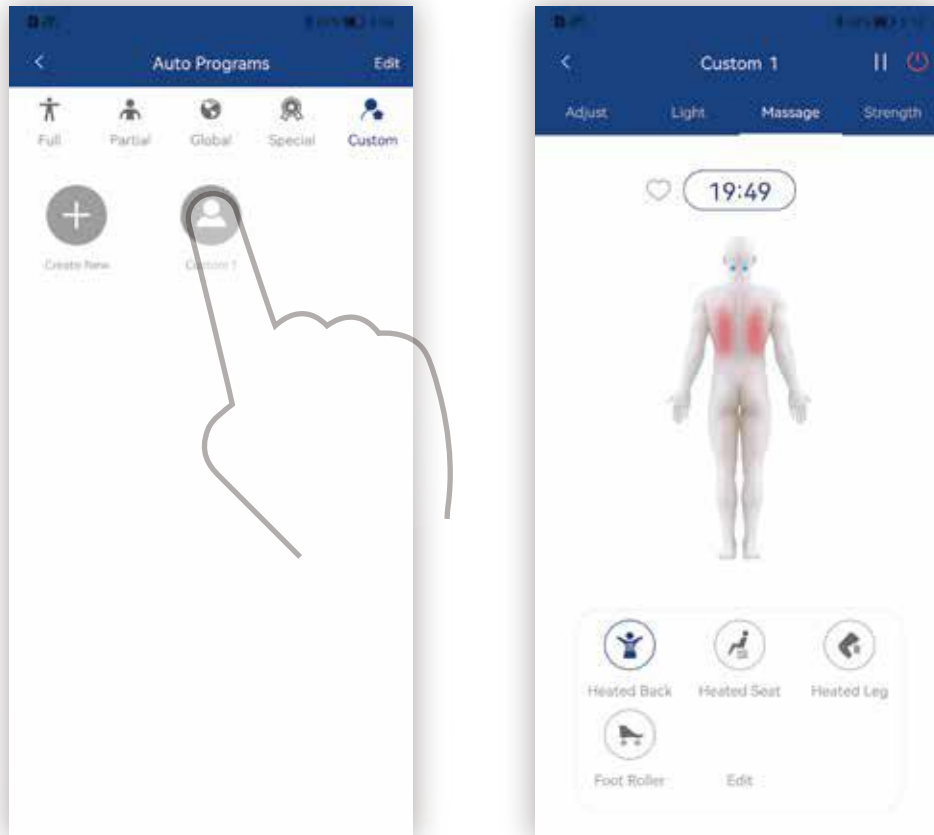

Choose the "Custom 1" icon to start your program

Data Interface

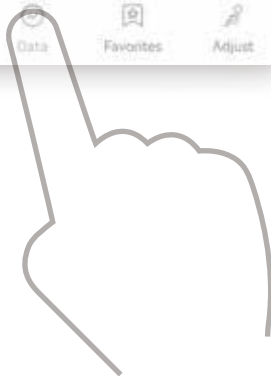
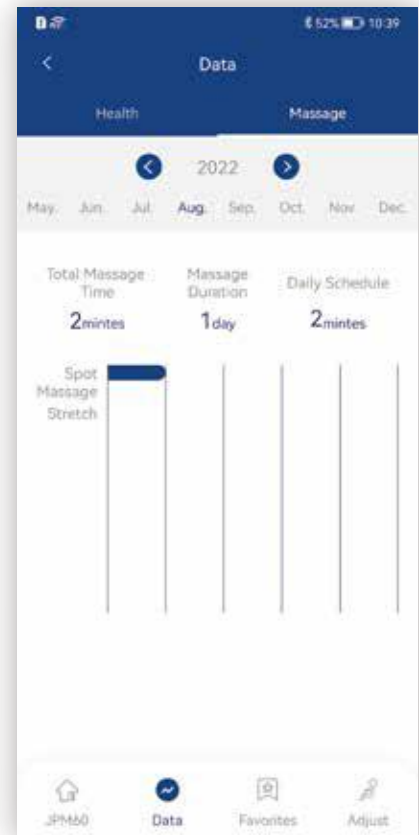
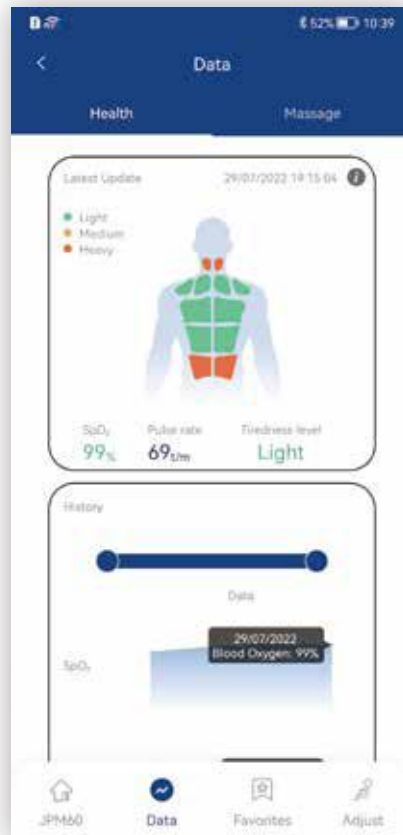
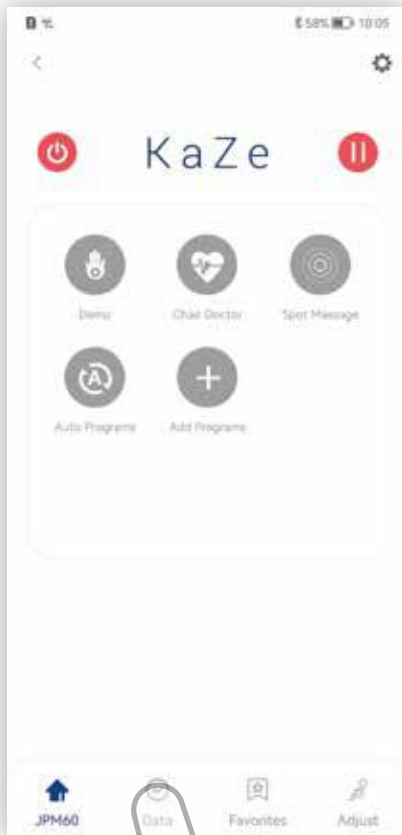

Check your health and message data here

Favorites Interface

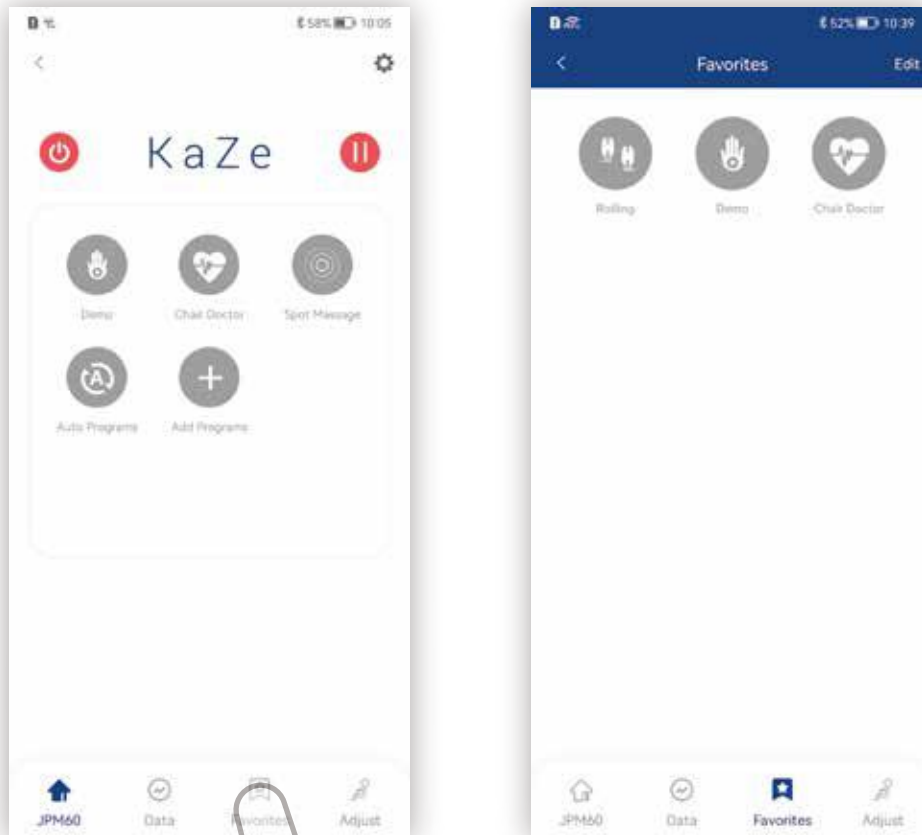

Adjust Chair Angle Interface



Settings

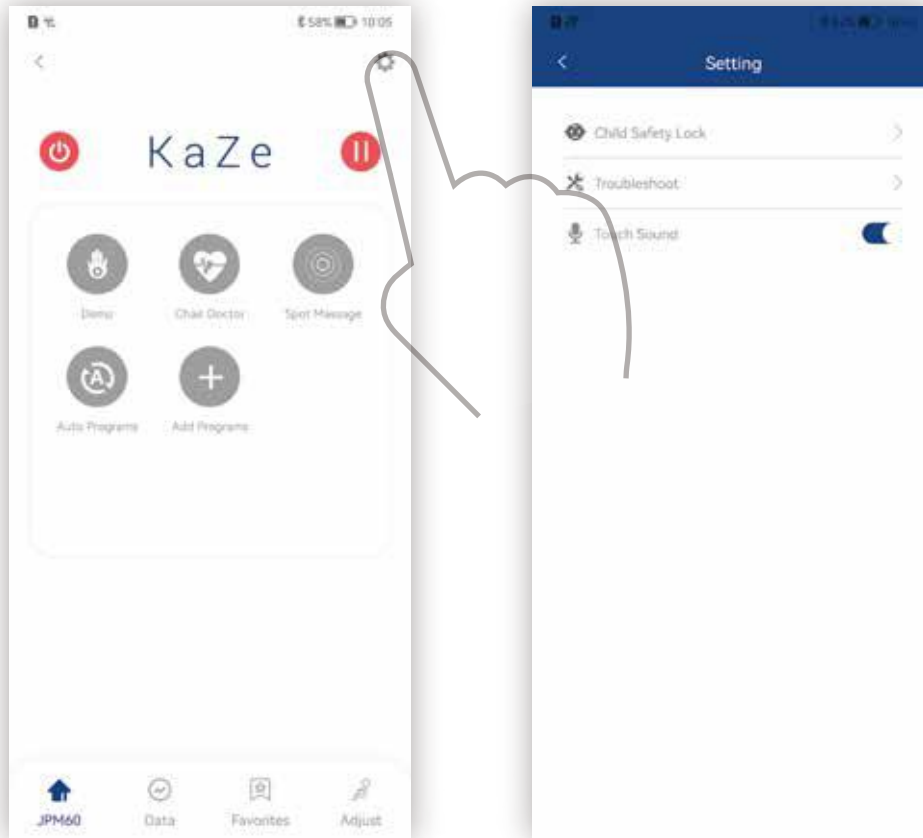

Click the "Settings" icon to take you to the settings page

Child Safety Lock

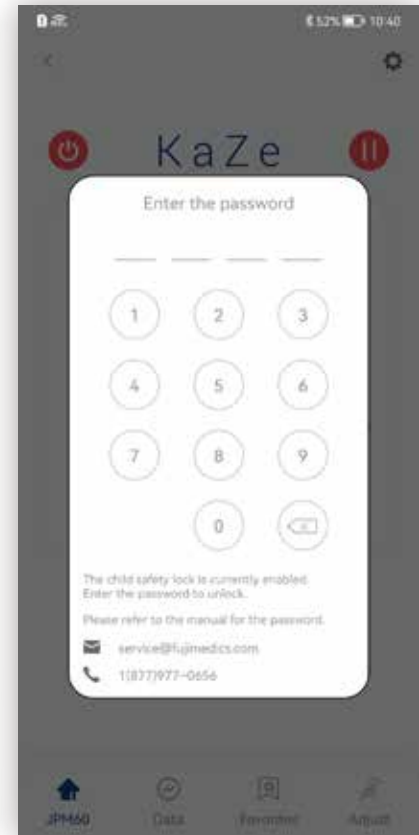
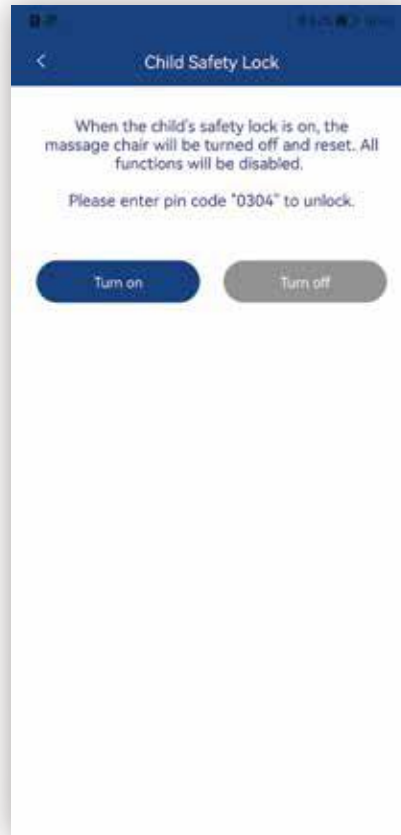
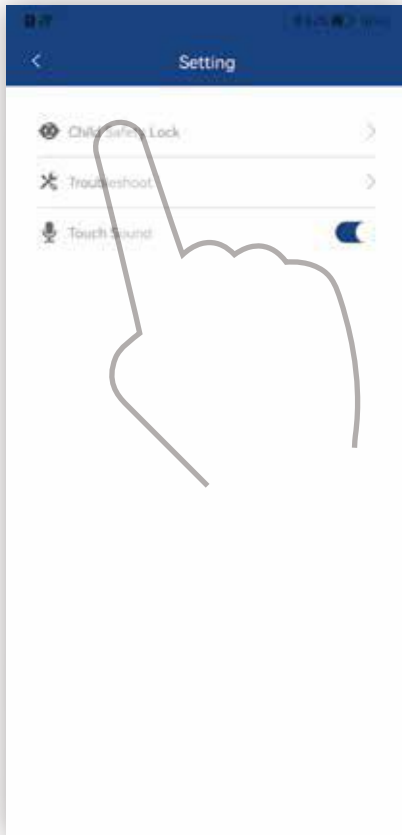

When the child safety lock is on, the massage chair will be turned off and reset.
All functions will be disabled. Please enter pin code "0304" to unlock

Trouble Shooting

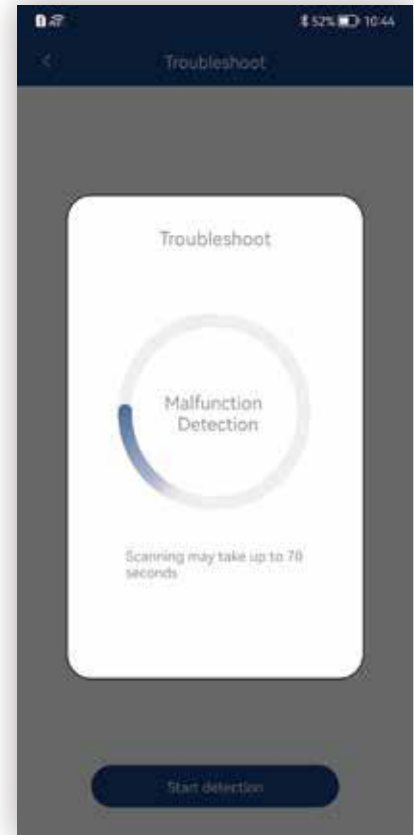
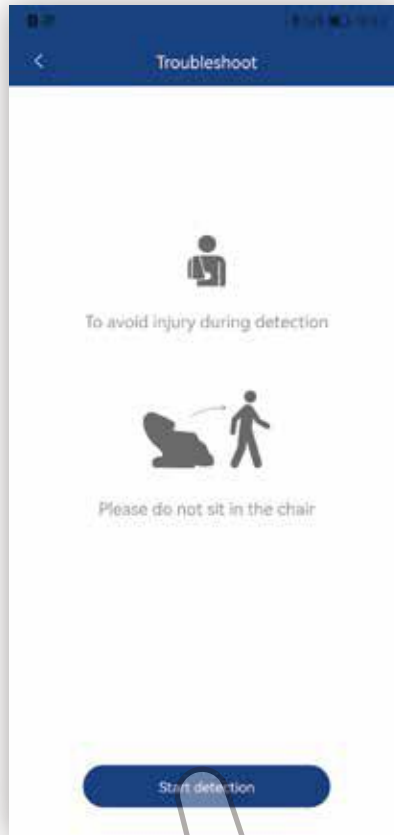

If your chair has any trouble, press the Trouble Shoot "Start" button for the chair to automatically detect problem areas. Use the error code provided when contacting our customer service team



You can use your detection code when contacting the customer service team about your chair's problems

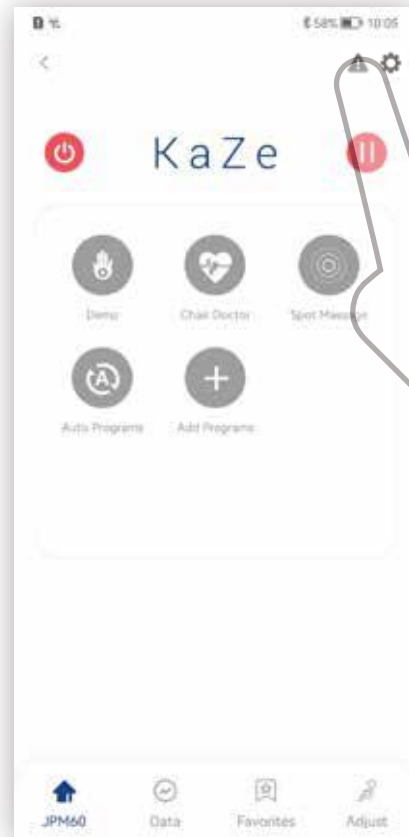

Click this icon to see the detection code

AUTO PROGRAM DESCRIPTIONS

Let's dig a little deeper and discover the details of our pre-programmed massages.

DEMO



A 5 minute whole body massage for those on the go.

FOCUS AREA

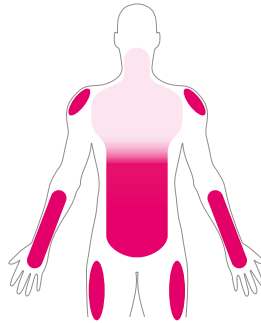

INTENSITY



FOCUS TECHNIQUE



KNEADING ROLLING SWEDISH

GENTLE



A program designed to provide a quiet, gentle massage that is good for beginners or those that prefer a soft touch.

FOCUS AREA

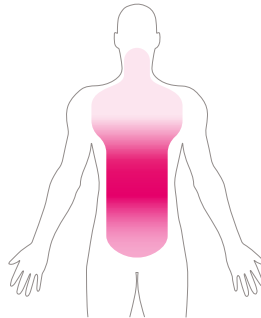

INTENSITY



FOCUS TECHNIQUE



KNEADING TAPPING

Stretch



This massage will stretch your legs and back with a combination of gentle tapping, rolling, and air compression.

FOCUS AREA

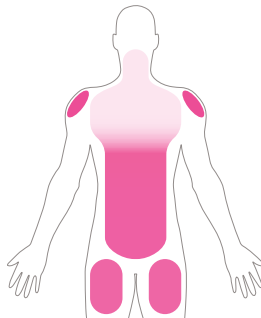

INTENSITY



FOCUS TECHNIQUE



KNEADING TAPPING

Recovery



A program that is designed to help your muscles recover and to relieve body tension after you exercise.

FOCUS AREA

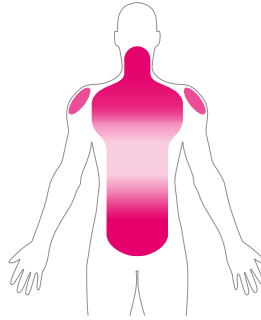

INTENSITY



FOCUS TECHNIQUE



KNEADING ROLLING TAPPING

Spine Care



This massage will focus on your lower back with a deep massage that includes air compression.

FOCUS AREA

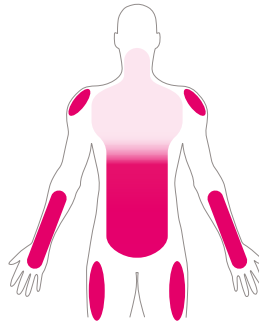

INTENSITY



FOCUS TECHNIQUE



SHIATSU KNEADING

RELAX



A program designed to provide a mild massage that is great for deep relaxation, best used before going to sleep.

FOCUS AREA

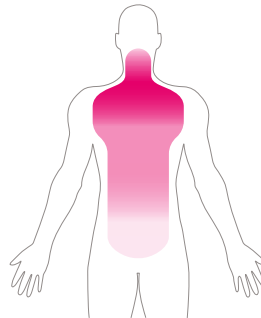

INTENSITY



FOCUS TECHNIQUE



SHIATSU SWEDISH ROLLING

Swedish



This massage will focus on your neck down to glutes in the beginning then finish with a soothing rocking motion.

FOCUS AREA

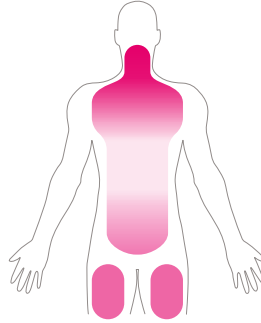

INTENSITY



FOCUS TECHNIQUE



KNEADING ROLLING

Vigorous



This massage will combine vigorous tapping on your lower back and an air massage focused on your thighs and legs.

FOCUS AREA

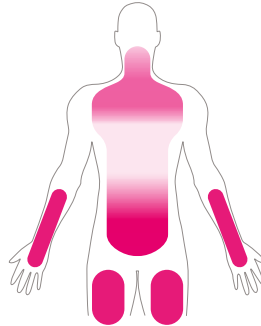

INTENSITY



FOCUS TECHNIQUE



TAPPING KNEADING

Thai



This massage will focus on your mid back and upper shoulders with a deep tissue massage using the shiatsu technique that will create an acupressure effect.

FOCUS AREA

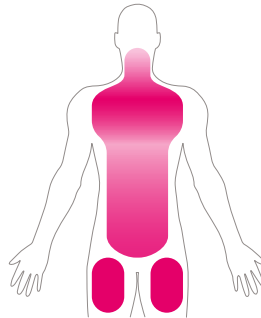

INTENSITY



FOCUS TECHNIQUE



KNEADING TAPPING

Japanese



A program designed using Japanese-inspired techniques to improve your immune system, blood circulation, and aid in pain relief.

FOCUS AREA

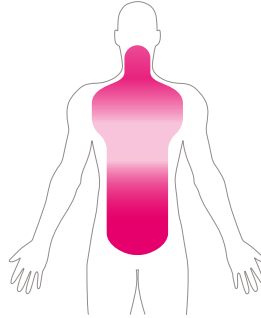

INTENSITY



FOCUS TECHNIQUE



SHIATSU KNEADING

Chinese



This massage will focus on your entire back while also massaging your legs and feet.

FOCUS AREA

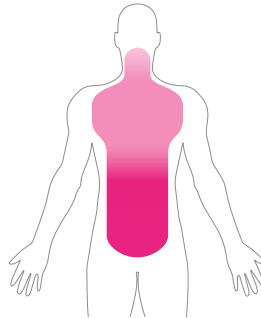

INTENSITY



FOCUS TECHNIQUE



KNEADING SWEDISH

Balinese



This massage will focus on your back and spine using fast, ultra kneading and tapping techniques.

FOCUS AREA

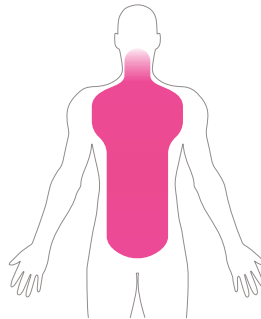

INTENSITY



FOCUS TECHNIQUE



SHIATSU KNEADING

Upper Back



This massage will focus on your neck, shoulders, and legs with a slow massage that incorporates soothing heat.

FOCUS AREA

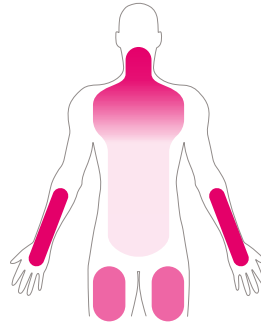

INTENSITY



FOCUS TECHNIQUE



KNEADING SHIATSU

Lower Body



This is a partial body program that focuses air compression and vibration on the lower body.

FOCUS AREA

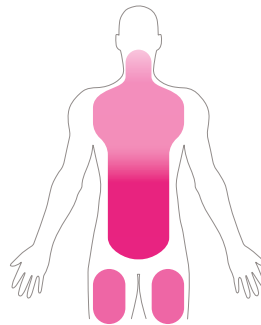

INTENSITY



FOCUS TECHNIQUE



KNEADING CLAPPING

Legs



A program that helps you relax your legs muscles.

FOCUS AREA

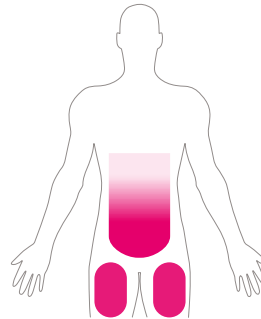

INTENSITY



FOCUS TECHNIQUE



SWEDISH CLAPPING

Rolling

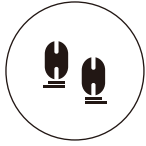

This program will massage from your neck down to your hips, using the ultra rolling technique.

FOCUS AREA

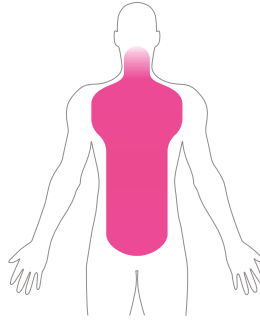

INTENSITY



FOCUS TECHNIQUE





ROLLING

IMPORTANT SAFETY INSTRUCTIONS

(MUST BE FOLLOWED)

The safety instructions must be strictly followed in use to avoid personal injuries and property damage as are follows:

- All the safety instructions are described in compliance with degrees of the injuries or damage as a result of wrong use.

 Warning	Actions tending to cause serious injuries or death
 Caution	Actions tending to cause minor injuries or property damage

- Pay attention to the symbols before safety instructions (an example is given below).

 Actions that must be absolutely forbidden	 Actions that must be followed
---	---

Warning

- Before using the product, persons who are being treated or have any of the following symptoms should consult a physician.

- (1) Persons with a pacemaker or other in-vivo electronic medical device tending to suffer electronic jamming.
 - (2) Patients with malignant tumors.
 - (3) Patients with heart disease.
 - (4) Persons proved to be unable to identify temperatures.
 - (5) Pregnant persons or women who have childbirth.
 - (6) Persons with perceptual disturbance because of diabetes or another serious peripheral circulation disturbance.
 - (7) Osteoporosis patients, spinal fracture patients or persons with acute painful diseases such as sprains or muscle strains.
 - (8) Persons with injuries in the massaged areas.
 - (9) Persons with a body temperature above 38 °C (with a fever) (For example, persons with intense acute inflammation symptoms such as listlessness, cold shivers and blood pressure change or persons in poor health).
 - (10) Persons who are unwell or must have a rest.
 - (11) Persons with an abnormal or bent vertebra.
 - (12) Persons with protrusion of intervertebral disc.
 - (13) Persons who feel very uncomfortable.
- Otherwise accidents or physical discomfort may happen.

- If you feel physically abnormal while using or experience no effect after use, stop the product immediately and consult a physician about it.
Otherwise accidents or physical discomfort may happen.

Warning

- Before using the massage chair or moving the backrest or the footrest, make sure there is no person or pet close to the chair (in front, behind, below or on the side).
- Before using the massage chair, make sure there is no foreign matter between the backrest and the back cover.
Otherwise accidents or physical discomfort may happen.

- Before using the massage chair, lift the backrest pad and check whether the fabric of the traveling sections of the massage rollers or other positions are damaged. (Even if the fabric is slightly damaged, stop the product immediately, pull out the power plug, and call customer service.)
If you use the product when the fabric is damaged, you may get injured or get an electric shock.

- Do not massage for more than 30 minutes each time.
- Do not massage a single area for more than 5 minutes.
If any of these safety instructions are not followed, you may suffer an adverse effect and become injured.

- After use each time, turn the power switch to OFF position and disconnect the power plug.
Otherwise accidents or injuries may happen.

- Follow the regulations about use of the socket and the devices.
- Use a 110-120V, 60HZ power supply. Don't use the product in a foreign country or connect it with a transformer without permission.
Otherwise electric shocks, product faults or fires because of overheat may happen.

Must be followed

- Insert the power plug thoroughly into the socket.
Otherwise electric shocks or fires caused by overheat may happen.

- Remove dirt/dust from the power plug at regular intervals.
Otherwise fires caused by poor insulation due to factors such as moisture may happen. (Wipe the power plug with dry cloth).

- In the case of any abnormality or fault, stop the product immediately and pull out the power plug to avoid smoke, fires and electric shocks.

Abnormality and fault examples:

- (1) The product fails to work after the power switch is turned to the ON position.
- (2) After the power line is moved, the product is discontinuously powered on.
- (3) During use, the product gives off a burning smell or an abnormal sound.
- (4) The product is deformed or abnormally heating.

In any of these abnormalities and faults, have the product inspected and repaired by JPMedics immediately.

- If there is any foreign matter between backrest and main PCB box cover, stop the product, disconnect the power supply and take out the foreign matter by opening the protective fabric covering at the lower part of backrest.
Otherwise product faults or personal injuries may happen.

Warning

- **Do not put the backrest pad between the backrest and the Main PCB box cover.**
Otherwise product faults may happen.
- **The following persons should not use the product.**
- **Persons for whom massage is forbidden by doctors, such as persons with thrombosis, serious aneurysm, acute venous aneurysm, various skin inflammations (such as subcutaneous tissue inflammation) or various skin infections.**
Otherwise disease may get worse.
- **The following persons should not massage their waists:**
 - (1) **Persons with acute lumbago, protrusion of intervertebral disc, or displacement of a lumbar vertebra.**
 - (2) **Persons with deformation or other discomfort of the hip joint.**Otherwise disease may get worse.
- **Do not put hands, arms or feet into the backrest's fabric.**
- **Children should not use the product. Keep them from playing on the product or climbing onto the footrest, the seat, the backrest, or the armrests.**
- **Do not climb onto the backrest or the armrests.**
- **Do not lean or sit on the backrest.**
- **Persons unable to express themselves clearly or unable to operate the product should not use the product.**
- **When massaging the neck, pay attention to moving directions of the massage rollers and do not massage with too much force or massage the front part of the neck.**
Otherwise accidents or personal injuries may happen.
- **Do not damage the power cord or the power plug.**
(Do not damage, forcedly bend, twist, or prolong the power cord or the power plug, or place the power cord or the plug close to a heater, or tie or bind any heavy objects on the power cord or the power plug).
A damaged power cord or power plug may result in electric shocks, short circuit faults or fires.
Please consult JPMedics about the maintenance method of the power line or the power plug.
- **Do not damage the foot heater section.**
- **Do not insert pins or needles into the product.**
- **Do not cut the product with a cutter.**
If the internal heater is damaged, fires or electric shocks may happen.
- **Do not insert or pull out the power plug with wet hands.**
Otherwise electric shocks may happen.
- **Do not disassemble or repair the product without permission.**
Otherwise fires, abnormal movements or personal injuries may happen.



Forbidden



Caution



- **The following persons (even if they are physically healthy at present) should consult a physician before using the product:**
 - (1) **Persons with muscular atrophy due to aging or thin persons.**
 - (2) **Persons feeling pain because of bone or viscus problems.**
 - (3) **Persons tending to suffer sprains or bruising.**
 - (4) **Persons with carsickness or seasickness or strong response when taking other transport means.**
 - (5) **Persons who once received a heat operation or another visceral operation.**Otherwise health may get worse.
- **Before sitting on the product, make sure there is no foreign matter between any two parts of it. (Make sure there is no foreign matter on the backrest pad, the backrest, the seat pad, the footrest or inside the surface of backrest pad.)**
Otherwise accidents, injuries, or product faults caused by clamping of hands, feet, or other articles by the product may happen.
- **Do not use the product when wearing any hard decorative article on hand (such as a watch). If there is any hard article (such as a mobile phone or key) in your pants pocket, take it out before getting into the chair.**
- **Before hand or arm massage, remove watch, rings, etc.**
Otherwise injuries may happen.
- **Before sitting on the seat, make sure the massage rollers are in the home position.**
- **If you want to leave the seat during the massage, stop the product first.**
Otherwise accidents or injuries may happen.
- **When pulling out the power plug, do not pull the power line but hold the power plug.**
Otherwise an electric shock or a short circuit fault may happen.
- **When moving the product by pulleys, put articles such as mats on the floor.**
Otherwise marks may be left on the floor.
- **Keep children from the retaining screws on the remote controller holder.**
Otherwise children may cause accidents or suffer injuries by eating it or playing with it.
- **Before moving the product by pulleys, remove the obstructions close to it. Lift the footrest to a position a little lower than the waist and move the product slowly.**
Otherwise accidents or injuries may happen because of turnover of the product.
- **In use, place the product horizontally.**
Otherwise accidents due to turnover the product may happen.
- **If any symptom such as skin inflammation, itching, or swelling occurs, stop the product immediately and consult a physician.**
Otherwise accidents or injuries may happen.



Must be followed

 Must be followed	<ul style="list-style-type: none"> • If the product is used again for massage after a period of out-of-service, read the user manual again and make sure the product can run normally first. Otherwise accidents or injuries may happen.
---	---

 Caution	
 Forbidden	<ul style="list-style-type: none"> • Do not use the product and other devices at the same time. Otherwise accidents or physical discomfort may happen. • Keep hands, abdomen and skin from the massage rollers and do not put hands or feet between the massage rollers. • Do not put the knees between the lower footrest and upper footrest. • Do not fall asleep while using the product. • Do not use the product after drinking. • If the air in the air bag on the seat is not completely discharged, do not stand or jump on the seat or put things on it. Otherwise accidents or injuries may happen. • Do not put hands or feet between the base and the footrest. • Do not put hands, arms, or head into the seam of the footrest. • For safety, admit the footrest after massage. • Do not put hands, feet or head between the backrest and the main PCB box cover. • Do not put pets on the product (such as its main PCB box cover, backrest and armrest). • Do not pull out the power plug or turn OFF the power switch suddenly during massage. Otherwise injuries may happen. • Do not stand or sit on the main PCB box cover. Otherwise personal injuries due to the product toppling may occur. • Do not stand or sit on the armrests. Otherwise personal injuries due to the product toppling may occur. • Do not drag or push the product after it is installed. Otherwise the floor may be damaged. • Do not move the product while there is a person on it. Otherwise, accidents, or injuries may happen due to a toppling of the product. • Do not use the product with heating devices such as electric blankets. Otherwise fires may happen. • Do not put the remote controller on the product. Otherwise the product may be damaged. • Wet-hand contact forbidden • Do not use the product in a bathroom or another wet place. Otherwise electric shocks or product faults may happen.

 Caution	
 Forbidden	<ul style="list-style-type: none"> • Product wetting forbidden. • Do not sprinkle substances such as water on the product or its remote controller. Otherwise electric shocks, short circuit or product faults may happen. • Pull out the power plug in the instances below. • Before cleaning or maintaining the product, pull out the power plug first. Otherwise electric shocks or injuries may happen. • In the case of a power failure, pull out the power plug at once. Otherwise accidents or injuries may happen when power is restored. • When the product is not used, pull out the power plug. Otherwise electric leakage fires may happen because of insulation aging caused by dust and moisture.

GROUNDING INSTRUCTIONS

The product must be grounded to reduce the electric shock hazard because of functional faults of the product. The product has a power cord with a grounding conductor and a grounding plug. The grounding plug must be inserted into an appropriate socket that has been correctly installed and grounded in full compliance with the local code and decree.

 Caution	
<p>If the grounding conductor is not correctly connected, electric shocks may happen. If you are not sure about correctness of the grounding, have it inspected by a professional electrician. If the grounding plug provided with the product does not match with the socket you have, do not refit it by yourself but ask a professional electrician to install an appropriate socket.</p> <p>The product has a grounding plug. Make sure the product is connected with a socket matching with shape of the grounding plug.</p> <p>Do not connect the product to a multi-plug.</p>	

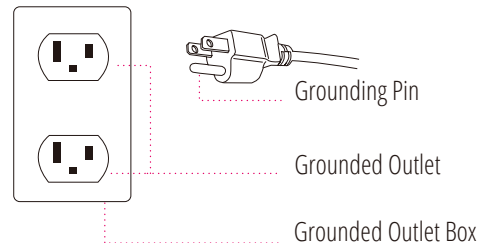

PRODUCT CLEANING

Wipe the synthetic leather with a soft dry cloth.

- Don't clean the product with chemicals such as thinner, gasoline and alcohol.
- When using a leather maintenance product (cleaning cloth) sold on the market, follow its directions for use.
- If the synthetic leather is very dirty, wipe it with the method below.
 - ① Put a piece of soft cloth into water or 3% to 5% neutral detergent contained hot water and wring it out.
 - ② Wipe surface of the synthetic leather with the soft cloth.
 - ③ Wipe the product with a piece of cloth once soaked in clean water and wrung out.
 - ④ Wipe with a piece of dry soft cloth.
 - ⑤ Allow the synthetic leather to air dry.
- If it is difficult to remove the stains on the synthetic leather, soak a piece of melamine foam bought from the market into a neutral detergent and use it wipe the product.
- Do not dry the surface with a hair dryer.
- Surface of the synthetic leather may be dyed by fabric colors; therefore, be careful when wiping the product with denim or colored cloth.
- Keep these positions from long-time contact with plastics to avoid fading.
- Synthetic leather may discolor, so the position in contact with the hair dye used should be covered by a towel.

CONSUMER WARRANTY

The JPM60/KaZe massage chair has a three year in-home service warranty. The warranty is only valid in the 48 contiguous states. We do not provide a warranty for chairs sold to Alaska or Hawaii.

Consumers may contact the JPMEDICS customer service department at 1-877-977-0656 between 9:00 am and 5:00 pm PST, Monday through Friday or email us at service@jpmedics.com for warranty or service issues.

The warranty period begins from the day of purchase; no allowance or extension is offered for delivery and/or installation.

The warranty only applies to the JPM50V massage chair, any accessories or enhancements are not included.

The JPMEDICS service department will make an appointment with the consumer before they arrange in-home service which is performed by an authorized technician.

In certain situations, the warranty does not apply:

A: Customer cannot provide receipt and warranty card.

B: Damage caused by improper installation, abuse, or improper maintenance.

C: Damage caused by disaster (ex. earthquake, fire, flood, etc.), abnormal power supply, breakages (ex. pets chewing, drink spilling, etc.).

D: Massage chair repaired by unauthorized technician or if unauthorized modifications occur to the massage chair.

If the synthetic leather, fabric, sponge, or fillers become naturally worn, they are not considered as defect under this warranty. Read the safety instructions before using this massage chair. Under no circumstance shall JPMEDICS or its representatives be liable for indirect, consequential, or incidental damages (including damages for lost profits, business interruption, bodily injury, and so on).

The warranty is not applicable if the massage chair is being utilized for business use.



JPMEDICS

861 S. Oak Park Road,
Covina, CA 91724

TEL: 1-877-977-0656
FAX: 1-800-521-4712
SERVICE@JPMEDICS.COM