

Limited Warranty

LEGACY 4 MASSAGE LOUNGER

Consumer Limited Warranty: ONE-YEAR WARRANTY

This warranty guarantees that the product purchased is to be free from defects in material and workmanship under normal usage and local voltage for a period of one year. This warranty expires in **TWO (2) years on parts, and ONE (1) year on labor** after the date of purchase.

U.S. JACLEAN, INC. (referred to as "the Warrantor") will repair this product with new or rebuilt parts in case of defects in material or workmanship, free of charge, in the USA provided that:

- 1) The product is operated in accordance with the printed instructions supplied.
- 2) The product is used under normal conditions for which designed.
- 3) The product is not subjected to misuse, negligence, or accident.
- 4) The product receives proper care, protection, and maintenance.

This warranty is extended to the original end-user when purchased from an authorized U.S. JACLEAN, INC. distributor. A purchase receipt or other proof of date of the original purchase is required for service and parts replacement under this warranty. This warranty does not cover shipping charges for defective items if a claim is made more than 30 days after the date of purchase.

This warranty only covers failures due to defects in materials and workmanship and does not cover normal wear or cosmetic damages. This warranty does not cover damages which occur in shipment, or failures which result from: accident, misuse (including, without limitation, failure to comply with instructions and use limitations contained in the Operating Instructions), abuse, neglect, mishandling, faulty installation, set-up adjustments, improper operation or maintenance, alteration, modification, a power line surge, lightening, improper line voltage, commercial use (e.g., as a service in a hotel, office, restaurant, or other business or for rental use), service by anyone other than from U.S. JACLEAN, INC., or damage that is attributable to "acts of God."

Continued use of this product after discovering a defect voids this warranty. This warranty shall be governed by the state of California, United States of America.

**IMPORTANT: CONTACT U.S. JACLEAN, INC. FOR REPAIR SERVICES.
DO NOT RETURN A DEFECTIVE PRODUCT TO THE STORE FROM**

Please retain this Warranty Certificate, together with the original purchase receipt, and present it to our technician for inspection during service.

For assistance and more information, please contact U.S. JACLEAN, INC.

Online warranty registration at: daiwamassage.com/warranty



LEGACY 4

MASSAGE LOUNGER

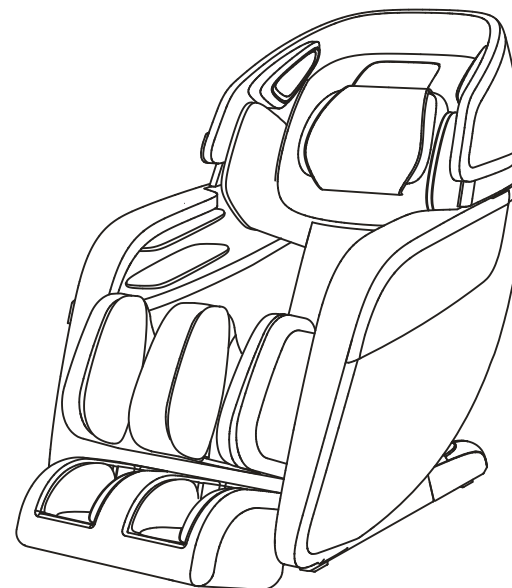

OPERATING INSTRUCTIONS

LGCY-4



Distributed by U.S. Jaclean, Inc.
1816 West 135th Street
Gardena, CA 90249

1-833-542-1918
9AM - 5PM PST (Monday - Friday)

daiwamassage.com

Thank you for purchasing the Legacy 4 Massage Lounger.
 Before using this chair for the first time, please read through all sections of this user manual carefully, paying special attention to the Safety Instructions.

PLEASE RETAIN THIS MANUAL FOR FUTURE REFERENCE.

▶ CONTENTS

SAFETY PRECAUTIONS	1
NAME AND FUNCTION OF EACH COMPONENT	3
Exterior Parts	3
Internal Parts	3
Controller	4
Remote Control User Guide	5
SPECIAL FEATURES	11
SETUP	12
Installation Method	11
Move Method	16
Installation Site	17
Where to use the Unit	18
Initial Operation	19
Before Sitting	19
Footrest Extension	20
Audio Function	20
After Use	20
Smart Phone App & Bluetooth	21
App Download	21
IOS System	21
CARE AND MAINTENANCE	22
TROUBLE SHOOTING	23
TECHNICAL SPECIFICATION	23

CAUTION

In Compliance with California Proposition 65 and other "Hazardous Substance" regulations, this is a notice that this product contains chemicals known to the state of California to cause birth defects or other reproductive harm. As with most electronics, the internal components of this product, such as the printed circuit board (PCB), Power Cable/Power Adapter wiring, and Metalwork contain amounts of Lead (Pb) that exceed the minimum threshold for reporting, requiring this notice, which protects and ensures consumer's "right to know." Since direct exposure to such chemicals will not occur during normal operation of this product, an exterior warning label was not required prior to purchase. For more information, please visit <https://www.p65warnings.ca.gov/fact-sheets/lead-and-lead-compounds>



This product comes with a guaranteed 10-year "Environment Friendly Use Period." The non-emitting lifetime of this electric product, when operated according to this manual, is limited to ten years. During this time, it is guaranteed to not emit hazardous substances, pollute the environment, or cause harm to persons or property.







Please dispose of all packaging and parts related to this product with environmental sustainability and safety in mind, and in compliance with state and local laws and regulations.

▶ SAFETY INFORMATION

Safety Information

Read all warnings carefully before use. Precautions and warnings listed below will help to ensure proper use of this appliance. The classes of accidents caused by incorrect use are classified into “WARNING” and “CAUTION.” Strict safety prohibitions are marked with the “Prohibited” symbol. Warnings against taking components apart are marked with a “Do Not Disassemble” symbol. Prior to use, please read all such statements below and follow all instructions within this manual.

 WARNING	Improper use may cause injury to users.
 CAUTION	Improper use may cause injury to users or product damage.
 Prohibited	 Do not disassemble

Use Not Recommended for Persons with the Conditions Listed Below

Those with any of the following conditions should consult their physician before using.

 WARNING	<ul style="list-style-type: none"> • Those who are using electronic medical instrument embedded in the body, such as a cardiac pacemaker. • Those undergoing treatment, especially those who are not feeling well. • Those with malignant tumors or malignant skin conditions. • Women who are pregnant or menstruating. • Those with osteoporosis or spinal fractures. • Those with a skin disease or those whose skin is injured. • Those with a high fever. • Close supervision is necessary when this product is used by, on, or near children, those with limited capacities or limited movement, and disabled persons.
---	--

Controller Precautions

 CAUTION	<ul style="list-style-type: none"> • Do not operate the controller with damp hands. Do not spill water or other liquid onto the controller and do not expose it to excessive humidity in order to avoid it from shorting or experiencing malfunction. • Do not place heavy objects on top the controller, as damage may occur.
---	--

AC Adapter and AC Cord Precautions

Very important: check that the power voltage stated on the rating label corresponds to your local electricity supply.





 CAUTION	<ul style="list-style-type: none"> • Do not use a damp hands to unplug the AC cord in order to avoid electric shock. • To avoid damage to the cord, do not pull on the AC cord itself; instead grab the head of the plug and pull straight out to unplug it. • Do not squeeze the AC cord by the appliance or other heavy objects. • Do not damage, over-bend, yank, twist, or tie the power cord. If the power cord is damaged, DO NOT USE. It must be replaced by the manufacturer or an appointed service agent before further use.
---	--

SAFETY INFORMATION

Usage Environment

 CAUTION	<ul style="list-style-type: none"> Do not use this appliance in environments where temperature is over 40°C/104°F. Ensure chair is placed on a flat, level floor prior to use. Do not use this appliance in an excessively humid or dusty environment, or when any part of the body is in contact with water. Keep the air openings free of lint, hair, and the like. Check clearance of passages regularly or when you experience a reduction in performance. Unplug entire chair from the outlet during thunder or lightning storms, and before putting on or taking off parts. Do not use outdoors. Do not store near heat or open flame. Avoid excessive sunlight.
---	---

Best Practices For Safe Use

 CAUTION	<ul style="list-style-type: none"> Intended only for users below 250lbs (120kg). Use this product only for its intended use as described in this manual. Do not use the product for therapeutic treatment purpose. This product is not intended as a replacement for treatment by a qualified, trained medical professional. Chair should only be used by one person—do not use with two or more persons at the same time to avoid damage to the products. Do not use the product right after a meal, as it may cause discomfort. Prior to use, remove jewelry and accessories from the arms, neck, and hands, and empty pockets. Check the upholstery and under the cushions and other spots, and if any damage is present discontinue use and contact the manufacturer for servicing. If you feel any abnormal discomfort during the operation of this product, turn off the power immediately and do not use further. Consult your doctor before resuming use. Limiting use of the massage chair for 20 minutes at a time is highly recommended. Make sure there are no obstructions behind the chair and that there is sufficient clearance before adjusting the backrest or legrest angle. Look out for pets or children when raising or lowering the chair. Make sure that no extra weight or pressure is pressing down on the backrest or legrest apart from the user. Make sure there are no children, pets or other objects under the backrest or legrest. Please stay properly seated while using the appliance. Do not drag or push the chair or caster across wood floor or carpet to avoid damage.
 PROHIBITED	<ul style="list-style-type: none"> Never operate this chair if it has damaged or if it has exposed parts or shows signs of power leakage. Do not stand on or stack heavy objects on the Legrest, armrests, or backrest. Children should be supervised to ensure that they do not play with the massage chair. Do not fall into sleep while the chair is operating. Avoid using the chair under the influence of alcohol or sedatives. Do not put hands or fingers in any openings of the chair to avoid injury to self or damage to the chair. If there is any smoke or unusual smell while using, stop using immediately and unplug the power cord.
 NO DISASSEMBLE	<ul style="list-style-type: none"> Do not disassemble this chair. Do not dismantle, fix or modify the chair yourself; please contact an authorized dealer or service agent.
 UNPLUG THE POWER CORD	<ul style="list-style-type: none"> Fully unplug the power cord before maintenance or moving. Never plug-in or pull out power cord with damp hands, to avoid shock or injury. Unplug the power cord when chair is not in use. Unplug from outlet when the power supply is cut, and switch all controls to off.

TROUBLESHOOTING

No.	Problem	Check the following:	Explanations / Remedies
1	Slight noises is heard during operation.	N/A	These noises are normal and arise from slight friction between the massage rollers and the leather cover.
2	Operation fails to start	Has the power plug slipped out of the wall outlet? Is the power switch in the "off" position? Has the fuse blown out?	Connect the power plug securely to the wall outlet. Switch power to the "on" position. Replace the fuse with another of the same type.
3	Airbags within the seat and the Legrest fail to work properly	Are the air tubes blocked?	Clear the air tubes of any blockages.
4	Airbags within the seat and the Legrest fail to work properly	The massage chair has detected some error that it is unable to display.	Turn off power, wait 10 minutes, and then turn it on again. If the problem persists, disconnect the power plug from the wall outlet and contact an authorized repairman
5	Music is not coming from the speakers even after Bluetooth is connected.	The volume on your Bluetooth device is set low or muted.	Adjust the volume on your device.

If you encounter problems operating the Legacy 4 Massage Lounger, please check the points above to see if they can be rectified. If your chair still malfunctions or does not work, please turn off the chair and remove the power plug from the electrical outlet. Contact Daiwa Repair Services at 833-542-1918 for assistance.

PRODUCT SPECIFICATIONS

Product Name	:	Legacy 4 Massage Lounger
Model Number	:	LGCY-4
Rated Voltage	:	110-120V~
Rated Frequency	:	60Hz
Rated Power	:	160W

CARE & MAINTENANCE

CLEANING

- ▶ Before cleaning, switch off power and remove the power plug from the wall outlet.
- ▶ Dip a soft, cotton cloth in neutral detergent and wring dry. Use it to wipe the pillow cushion, back cushion, armrests, Legrest, and any plastic parts of the chair.
- ▶ Use a piece of wet cloth (without detergent) to re-wipe the pillow cushion and back cushion. Place them in a well-ventilated location for drying.
- ▶ Use a soft, dry cloth to re-wipe the armrests, Legrest, and any plastic parts of the chair.
- ▶ Use a soft, dry cloth to wipe the controller, the DVD player, and the power supply box.

CAUTION

- ▶ Before any maintenance, always disconnect the power plug from the wall outlet.
- ▶ To avoid electric shock, never touch the power plug with wet hands.
- ▶ When cleaning the back cover of the massage chair, do not allow any detergent to seep into the power supply box.
- ▶ Do not use abrasive chemicals, such as benzene or alcohol, to clean this chair.
- ▶ Damage to the chair may result.
- ▶ DO NOT apply an iron or any other heated device to the chair.

STORAGE

- ▶ Before putting into storage, wipe off all accumulated dirt and dust from the surface of the chair. Cover the entire surface of the chair with a dust cover (not included).

CAUTION

- ▶ Do not store the product under direct sunlight, nor in a location with high temperatures. Doing so may cause the upholstery to fade.

MAINTENANCE

Upon detecting any of the following conditions during daily use, immediately turn off power, disconnect the power plug from the wall outlet, and contact an authorized repairman:

- ▶ A burning smell
- ▶ Power cord feels hot.
- ▶ Any other abnormal symptoms
- ▶ Cord is plugged in and the power switch flipped on, but no functions operate.

CAUTION

- ▶ To avoid fading of the PU leather upholstery, do not store the product under direct sunlight and avoid storing in a location with high temperatures

PARTS

EXTERIOR PARTS

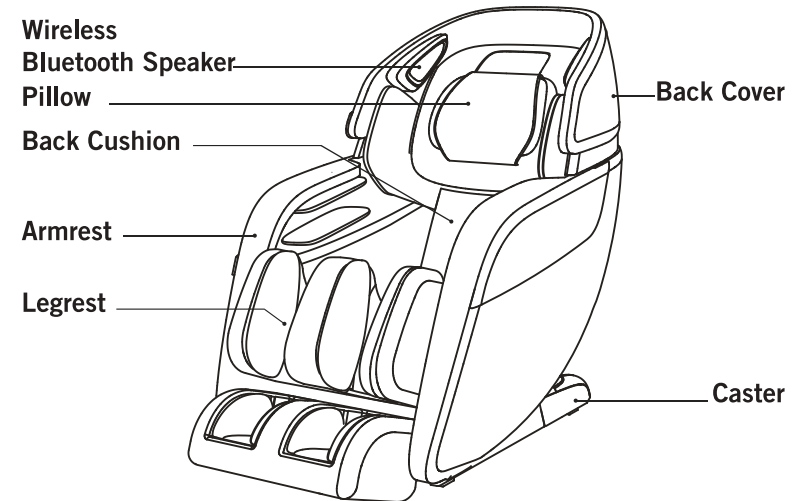

INTERIOR PARTS

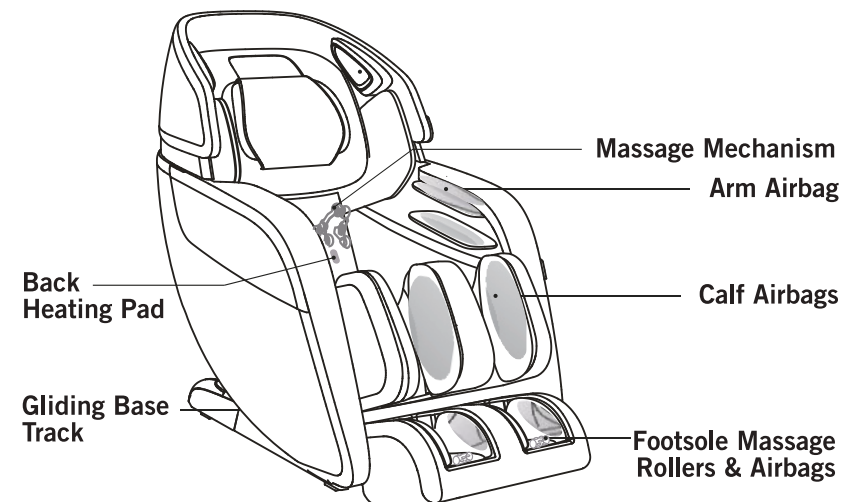

PARTS

CONTROLLER

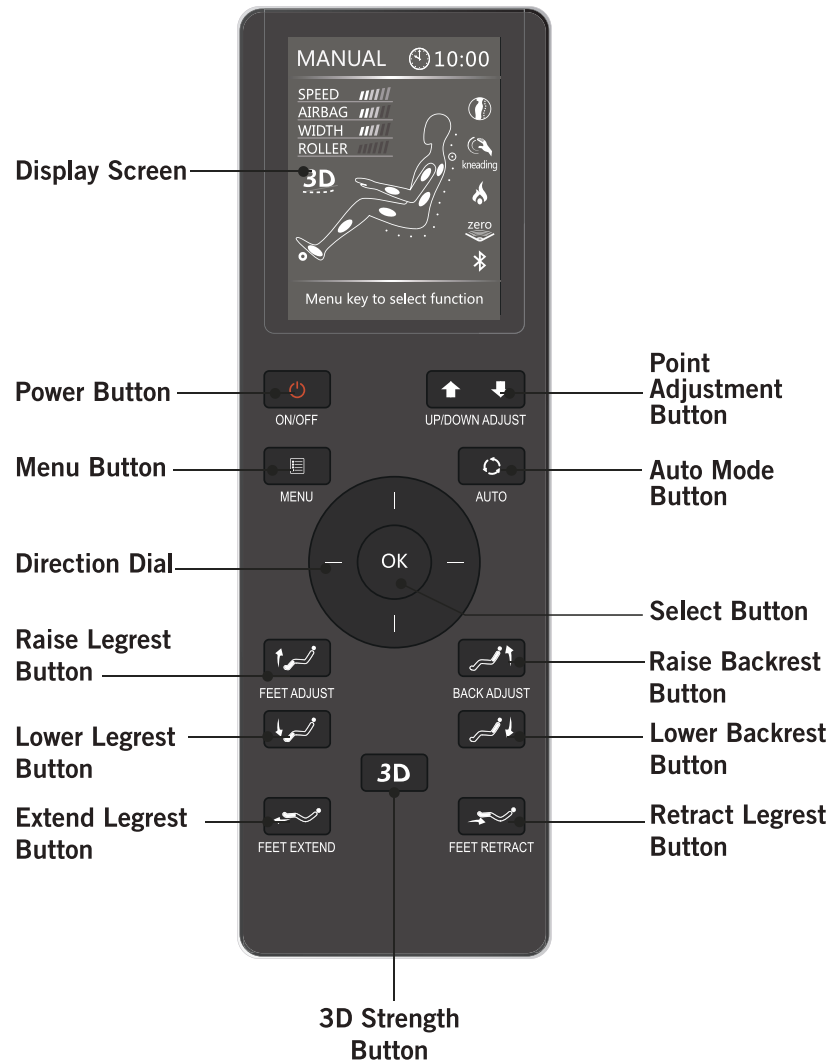

SMARTPHONE APP & BLUETOOTH

To listen to music or have the chair synchronize its massage movements to your music, connect any wireless (Bluetooth-enabled) music player to the chair's wireless Bluetooth speakers.

- Note: there is also an extra audio input jack next to the controller input, in case you do not have a wireless Bluetooth music device.

LEGACY 4 APP DOWNLOAD & INSTALLATION

The app for controlling the massage chair via your smart device works via a wireless (Bluetooth) connection.

- Once you install the app and open it, you will be prompted to connect to the chair from your device using Bluetooth and then you may control its features from your device.

APPLE IOS

1. In the App Store, search for the Legacy 4 Massage Chair. Install and open the app.
2. From within the app, connect to the chair via Bluetooth.

▶ SETUP

FOOTREST EXTENSION

- ▶ Press and hold on the “” or “” Button to extend or retract the Legrest to the desired position, and release to stop.

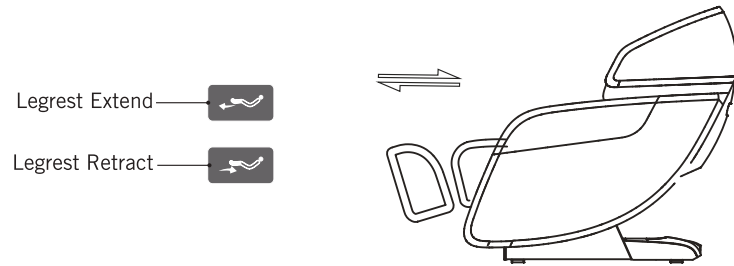

- ▶ Pressing either button once will adjust place automatically until it is in right position.

Warning

- ▶ Do not play on the chair or use it incorrectly.
- ▶ Always confirm that there is nothing behind the chair and that there is sufficient space to recline the chair or lift the Legrest.
- ▶ Never insert legs, feet, hands, or any objects into the openings while the Legrest extending or retracting.
- ▶ Do not get out of the chair while it is automatically resetting; instead wait until movement has completed.

AUDIO FUNCTION

- ▶ Activate Bluetooth function via controller, search “LGCY-4” on your mobile device and pair it.

AFTER USE

- ▶ Always unplug the massage chair from the electrical outlet immediately after use.
- ▶ Put the Controller into the Controller Pocket.
- ▶ Turn off the power switch and unplug the massage chair from the electrical outlet while not in use to avoid children start the massage chair accidentally.
- ▶ When not in use for a long period of time, we recommend that the chair be covered, the power cord be coiled and that the unit be placed in an environment free of dust and moisture.

▶ REMOTE CONTROL USER GUIDE

CONTROLLER OPERATION

Power Button

- ▶ Press to turn on the unit. The display screen will light up. Use the Direction Dial to highlight your preferred massage mode and preference. Press the center OK key to select.
- ▶ Press again to turn off all functions.

Menu Button

- ▶ During any massage operation, press here to select a massage function or to start or stop a feature during your current massage program.

Point Position Adjustment Buttons

- ▶ While the Point Mode manual program in running, use to adjust the massage location point to your desired position. Use this to target a specific sore spot, for example.

Auto mode button

- ▶ Press to access the chair's Automatic Massage Programs.

Direction Dial



- ▶ To navigate the menus on the display, use the Up, Down, Left, or Right direction keys to move among selections. Press the center OK key to confirm a selection.
- ▶ During a massage, press the Up or Down direction keys to adjust the massage speed. Press the Left, Right direction keys to adjust the airbag force.

3D Roller Adjustment

- ▶ Press to adjust the strength of the 3D rollers during and an Auto Mode or Manual Mode massage program. (During a 3D Mode massage program, roller strength is set automatically.)

Raise Legrest Button

- ▶ Press and hold to raise the legrest to your desired position.

Lower Legrest Button

- ▶ Press and hold to lower the legrest.

▶ REMOTE CONTROL USER GUIDE



Backrest Up Button

▶ Press and hold to raise the Backrest.



Backrest Down Button

▶ Press and hold to lower the Backrest.



Extend Legrest Button

▶ Press and hold to extend the Legrest.



Retract Legrest Button

▶ Press and hold to retract the Legrest if your legs need more room.



WARNING

After a massage, pressing the Power button will restore the chair to its default position. If you change your mind and wish to stop it from doing so, press any button on the controller to stop the chair from returning to its default, and then press the Power button again for further operation.

DISPLAY SCREEN OPERATION

Instructions: Navigate the menus using the Direction Dial. Press Right to go to the next sub-menu of your current selection and press Left to return the previous screen. Up and Down move through the listed options. Press the center OK button to make a selection.

AUTOMATIC PROGRAMS

Press  followed by  to bring up the Automatic Programs menu.

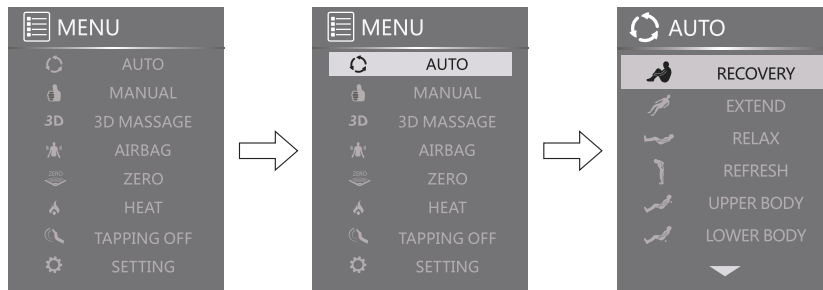

▶ SETUP

INITIAL OPERATION

- ▶ Make sure there are no objects, people, or pets in the vicinity of the unit.
- ▶ Prior to sitting, use the controller to recline the Backrest to its furthest outstretched position and raise the Legrest to its highest position.
- ▶ Make sure that sufficient open space surrounds the chair on all sides. Check to make sure that the Legrest is properly connected to the main body of the chair.
- ▶ Return the chair to its original, upright position.

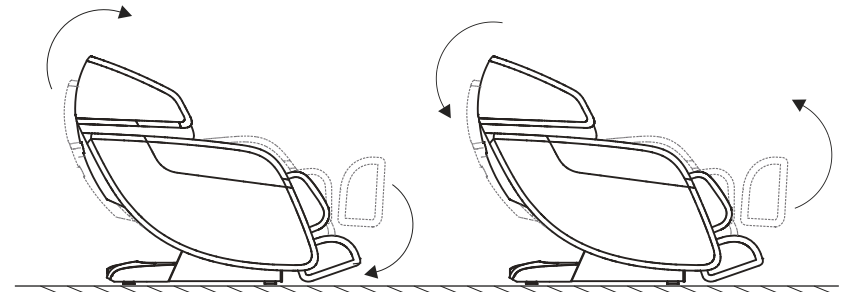

BEFORE SITTING

- ▶ Verify that the Legrest Massage Unit is well secured onto the main chair body.
- ▶ Make sure all components appear properly secured. If not, switch the power Off and completely secure all parts.



WARNING

- ▶ Do not allow anyone to sit on the Legrest while the Legrest is rising.
- ▶ To avoid possible damage, do not suddenly load the Legrest with heavy weight.

▶ SETUP

WHERE TO USE THE UNIT

- ▶ When placing a mat under the unit, the size of the mat should be sufficient to
- ▶ cover the areas where the unit touches and where the leg rest could touch the floor (at least 48in. by 72in.; or 122cm by 183cm).

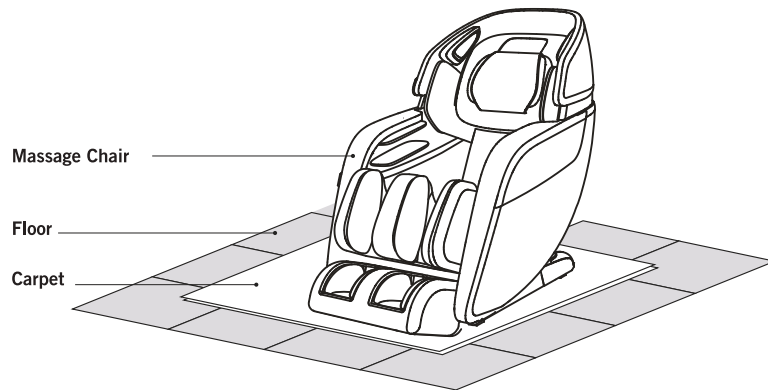

BEST CIRCUMSTANCES



To prevent possible electrical leakage, do not place the massage chair in or near a damp environment, such as a bathroom or spa.



Do not expose the massage lounger to direct sunlight or high temperatures, such as in front of heating sources, because this can cause discoloration or hardening of the synthetic leather.

Grounding



This massage chair belongs to Class I of the IEC Protection Class. Be sure to use a three-prong power supply socket. To avoid electric shock, leakage, or other electric risk, ensure the ground wire connected to the power supply has obtained a stable ground connection.

▶ REMOTE CONTROL USER GUIDE

Use the Direction Dial to choose one of the nine Auto Massage programs:

Auto Program Name	Description
RECOVERY	Warm up
EXTEND	Stretch
RELAX	Cool down
REFRESH	Light massage
UPPER BODY AUTO	Focused massage on the upper body
LOWER BODY AUTO	Focused massage on the lower body
ROYAL TREATMENT	Pressure Point back massage
STRESS RELIEF	Invigorating neck and shoulder massage
GENTLE CARE	Light back massage

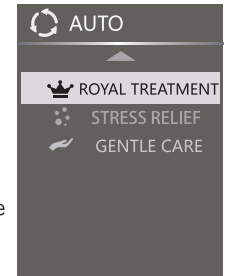

MANUAL PROGRAMS

Direction: Press the Menu Button  and scroll down to the Manual option. Press the OK button to select. Use the Directional Dial to choose a massage and options based on the descriptions below. Press Right and Left to select menus and OK to set options

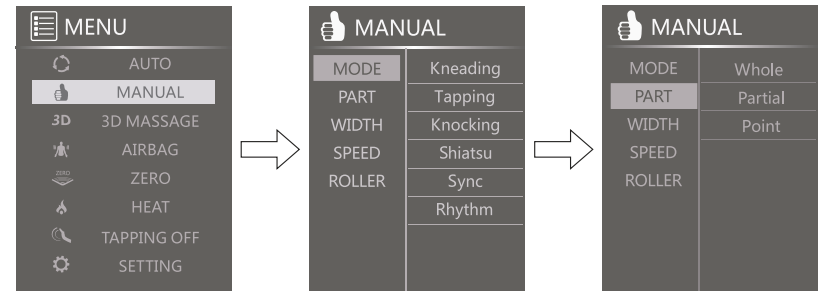

MODE

Use the direction Dial to choose between Kneading, Tapping, Knocking, Shiatsu, Sync or Rhythm Massage Modes. Kneading offers the options of Kneading Up or Kneading Down.

KNEADING

Kneading offers the options of Kneading Up or Kneading Down. .

PART

Part offers the option to massage the entire back, to focus on one area, or to focus on a single point.

WIDTH

Width offers adjustments on how far the rollers spread out from the center of the back.

▶ REMOTE CONTROL USER GUIDE

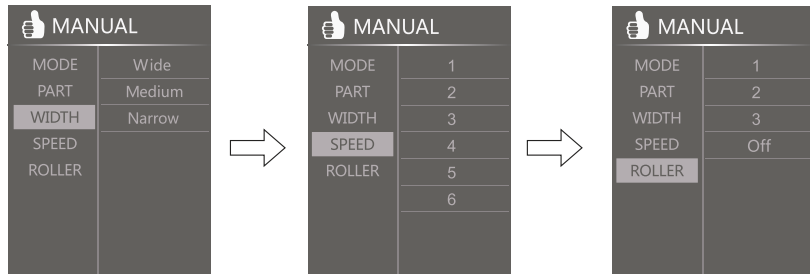

SPEED

Adjust Back Roller speed levels from slow to fast, 1 to 6.

ROLLER

Foot rollers can be adjusted from speed levels 1-3 or turned off

▶ 3D Massage

Use the Direction Dial to choose one of the three 3D Massage programs: Deep Shiatsu, Breathe, or Revive.

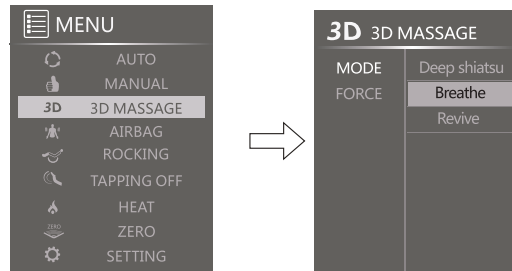

Force

Adjust the strength of the 3D rollers from weak to strong, 1-5. You can adjust the strength during any auto or manual program. You cannot adjust the strength



▶ AIRBAG

Massaging airbags can be adjusted to focus on a particular area only. You can also adjust the strength of the Airbags or turn them off completely.

▶ SETUP

INSTALLATION SITE

When looking for a location to place your massage chair, keep following in mind:

- ▶ The chair takes up more space when stretched out, than when in an upright position. With the chair upright, allow at least 3 inches of open space behind the backrest, and at least 19 inches of space in front of the Legrest.
- ▶ To prevent wearing out the floor beneath the chair, we advise placing some cushioning material, such as a rug or plastic mat, underneath the chair.
- ▶ To prevent fire or damage to its leather material, keep the massage chair away from any sources of heat (such as a stove or furnace).

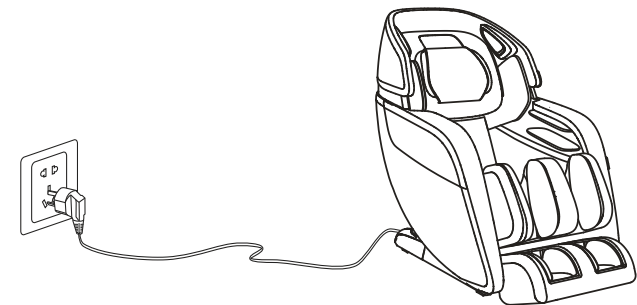
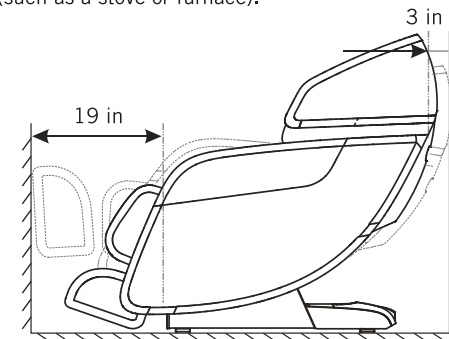

⚠ CAUTION

- ▶ Keep the distance between the power socket and power switch within 59 in. to avoid damage of power cord while massage chair sliding forward.
- ▶ Straighten the power cord while in use to avoid tangle or damage.
- ▶ When the massage chair sliding forwards or back, please check to make sure

▶ SETUP

MOVE METHOD

- ▶ Make sure that the backrest is in its highest upright position.
- ▶ Shut off power and remove the power plug from the wall outlet.
- ▶ Standing behind the back of the chair, grasp its backrest and tilt it downward, so that the front of the chair rises off of the floor. Push the chair to the location you desire.

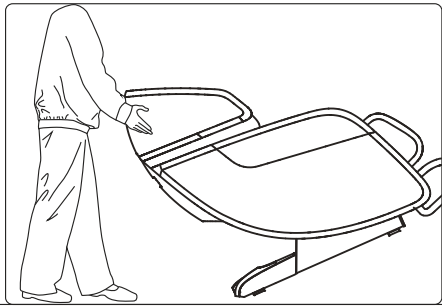

⚠ CAUTION

- ▶ Do not attempt to move the chair while someone is still sitting on it.
- ▶ When moving the chair, always grasp it by the backrest. Do not move the chair by pulling its armrests, as the armrests can dislodge.

CONNECT TO POWER

⚠ CAUTION

- ▶ Before plugging in, inspect the entire power cord and plug for any possible damage. Make sure that no electrical wires are exposed.
- ▶ Make sure that the power supply switch is turned OFF before inserting the power plug into a wall outlet.

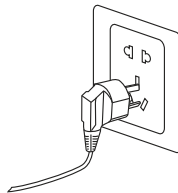

▶ REMOTE CONTROL USER GUIDE

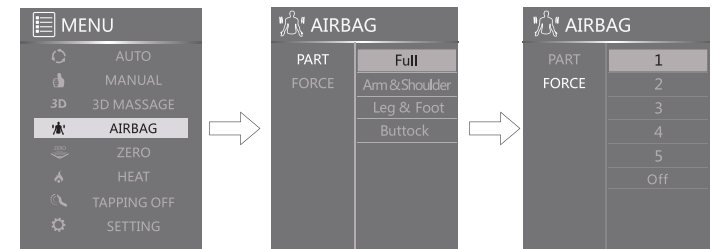

▶ ZERO GRAVITY

Use the Direction Dial to activate Zero Gravity recline mode 1 or 2, or select Off to return to default upright position.

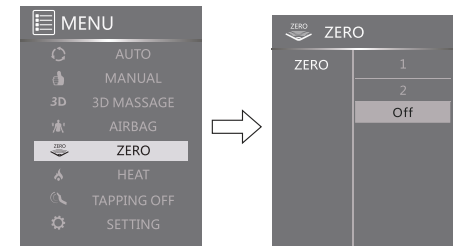

▶ HEAT

Use the Direction Dial to turn the Heat feature on or off.

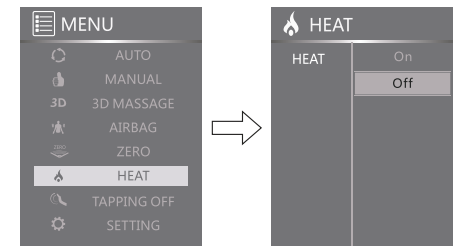

▶ TAPPING OFF

Use the Direction Dial to turn the Tapping Massage function on or off.

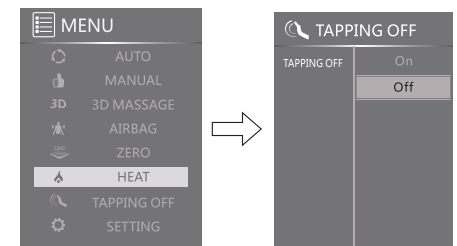

▶ REMOTE CONTROL USER GUIDE

SETTING

Settings allow you to change the duration, to set your language, to turn on Bluetooth, and to turn ambient lights on or off. Use the Direction Dial to navigate and set these options.

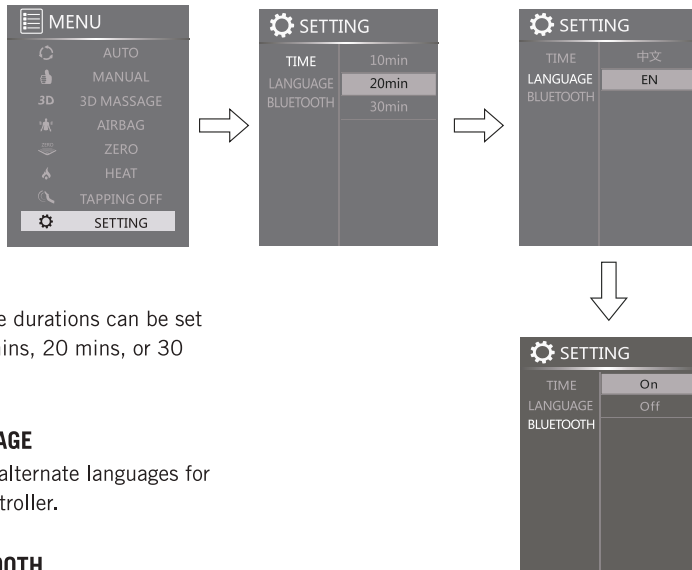

TIME

Massage durations can be set to 10 mins, 20 mins, or 30 mins.

LANGUAGE

Access alternate languages for the Controller.

BLUETOOTH

Turn Bluetooth on or off.

Notes:

- Upon making any selections within the Automatic or Manual Mode menus, after 10 seconds of inactivity, the display screen will return to the home page.
- With the exception of the "Lower Auto" option, each automatic program will begin with the movement of massage nodes along the backrest, in order to pinpoint the user's shoulder position.

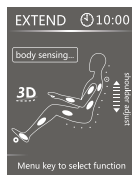
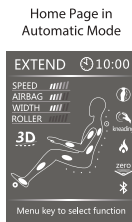

▶ SETUP

5: Installing the Controller Unit

- ▶ Connect the controller to its corresponding port on the Power Supply Box. Use the Screw Cap to tighten the connection.

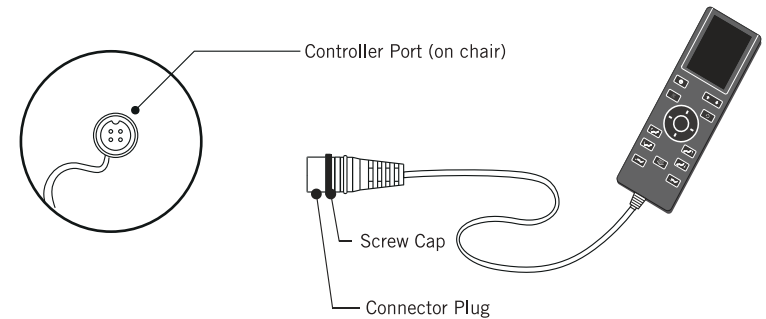

6: Power Supply

- ▶ Insert the Power Cord to the Power Cord Port located on the back of the Power Box. (Check below illustration for reference)
- ▶ Switch the power to ON using the switch on the lower side of the right armrest. Raise the backrest of the product to its fully upright position.

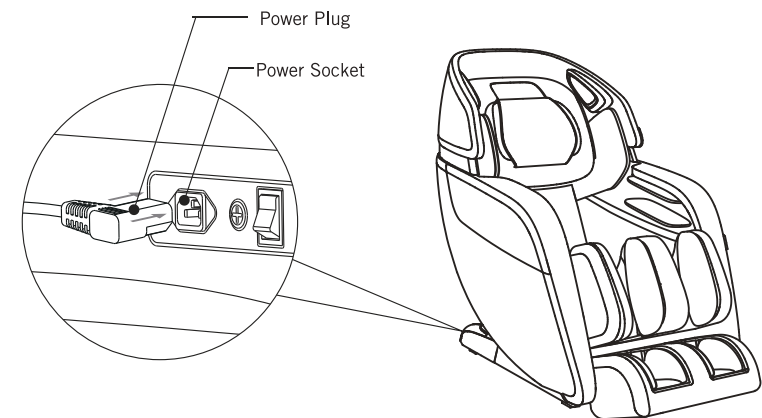

▶ SETUP

- ▶ Bundle the Air Hoses using cable ties, but take care that they are not too tight or else the Air Hoses could be compressed and the chair will not work properly.

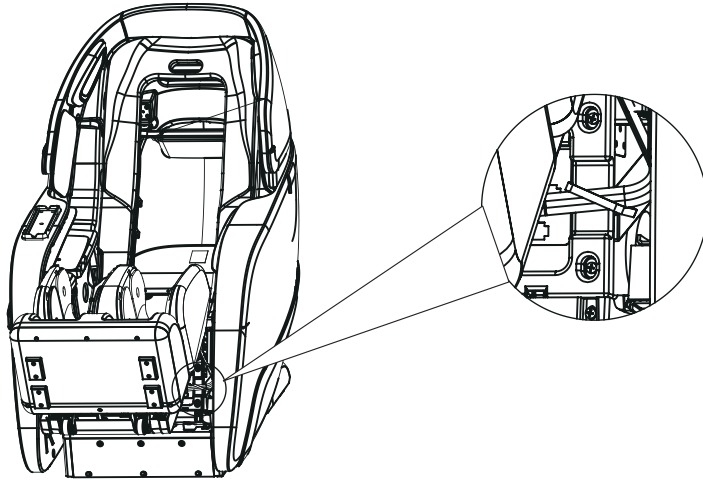

4: Install the Legrest Unit Accessories

- ▶ Lift the Legrest by reclining the chair. Turn off the power switch and remove the power cord. Attach the corresponding connectors to the ports located on the back of the Legrest.

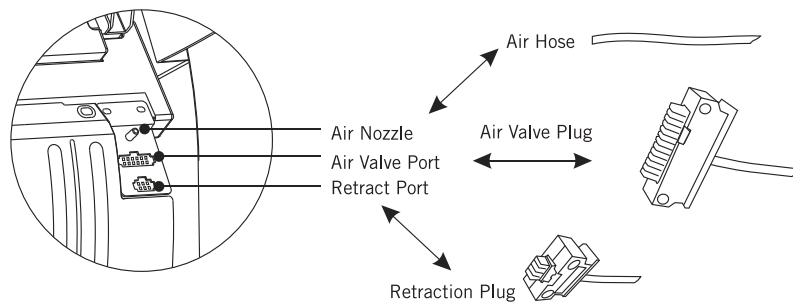

▶ SPECIAL FEATURES

1. Space Saving Wall Hugger Design

The gliding recline mechanism takes up much less space, allowing the entire chair to fully recline when placed just 3" from any wall.

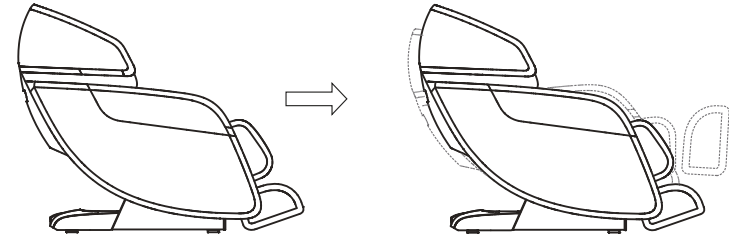

2. 3D Massage Rollers

By moving in multiple directions, the rollers have an extra plane of movement that allows them to follow the natural contours of your body.

3. Mechanized Leg Extension

The foot massager easily extends up to 5.5 inches, to provide the most effective massage for users of any height.

4. Full Body Airbag Massage

Airbags inflate and deflate in rhythm with other massage functions to improve circulation and relieve body fatigue.

5. Triple Reflexology Foot Rollers

Our foot rollers stimulate nerve endings on the feet to relieve tension, improve circulation, and renew vitality throughout the entire body.

6. The Touch of a Personal Masseuse

Kneading, tapping, knocking, shiatsu, sync, rhythm: The Pegasus 2 Smart is able to copy the feel of a masseuse.

7. Easy-to use Remote Control

Choose from 21 auto programs or 6 customizable manual programs with the easy-to-operate hand held remote.

8. Unique L-Style super long massage guide track

The extra-long, L-Shaped Massage Track runs from the top of the shoulders to the top of the thighs.

▶ SETUP

INSTALLATION METHOD

1: Unpack Parts & Check

- ▶ Carefully lift the chair and all of its parts from packaging.
Remove any protective wrapping and check to make sure that all parts are present.

2: Install the Armrests

- ▶ Connect the Air Hoses of the base unit to the Air Nozzles of one Armrest.
(Illustration 1)

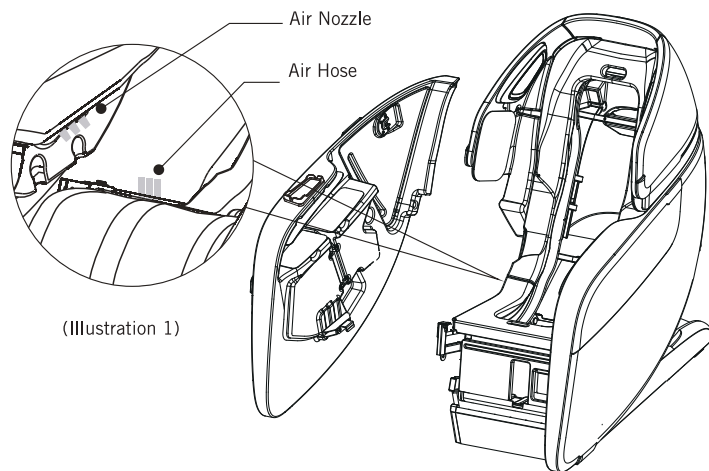

(Illustration 1)

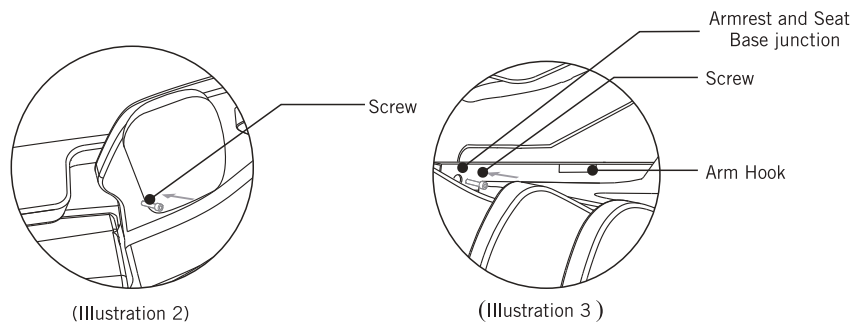

(Illustration 2)

(Illustration 3)

- ▶ Slide the Arm Hook of the Armrest onto the Chair Base and secure a screw at the rear end of the Armrest first, and then secure a screw at the front of the Armrest.
- ▶ Repeat steps for the other Armrest.

▶ SETUP

3: Installing the Footrest

- ▶ Lift the footrest and connect it with the coupling shaft by hanging (pay attention to the balance), move the hook to one side of the coupling shaft, then attach the other side.
- ▶ Pay attention to the balance, then attach the other side.

