



Kitchen



Bathroom



Basement



Laundry Room

Replacement Cabinet Components

Cabinet Doors + Drawer Boxes + Drawer Fronts + Veneers + End Panels + Cabinet Shelving



Cabinet Doors

Wood Cabinet Door Styles

Height and width available in 1/16" increments. Minimum dimensions apply to each door.



Lancaster Veneer Slab*
Slab

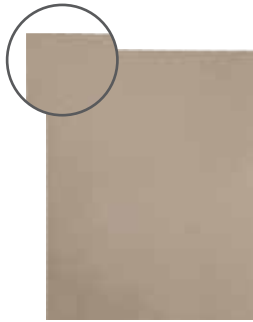

Lexington MDF Slab
Slab



Wilmington Shaker
Shaker Flat Panel



Wilmington
Recessed Flat Panel



Asheville
Square Raised Panel



Shelby
Arched Raised Panel



Concord
Cathedral Raised Panel

**All flat panel doors have a veneer insert. All raised panel doors have a solid wood insert.*

**Richmond veneer slab is only available in hard maple and cherry*

**MDF doors available in Wilmington, Wilmington Shaker, Asheville, Shelby, and Concord door styles.*

Wood Species



Red Oak



Hard Maple



Paint Grade Hard Maple



Cherry



MDF

*Lead time for product shipment is 10 business days from when the order is processed.
Orders may ship from different manufacturing locations and arrive separately.*



Cabinet Doors

White RTF Cabinet Door Styles

(RTF=Rigid Thermofoil)



*Naples**
Rounded-Corner Raised Panel

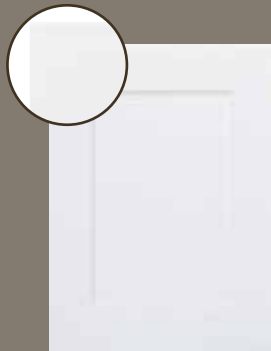

Naples Shaker
Shaker Flat Panel

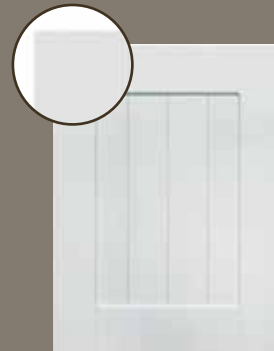

*Marathon Beaded Shaker**
Beaded Shaker Flat Panel

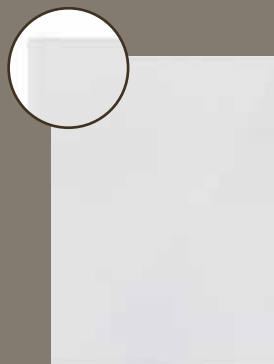

Venice
Slab Flat Panel



*Daytona**
Square-Corner Raised Panel

*available in Medium Density Fiberboard (MDF). MDF is for priming and painting only.



Cabinet Doors

Wood Mullion Cabinet Door Styles

Wilmington Wood Mullion Doors

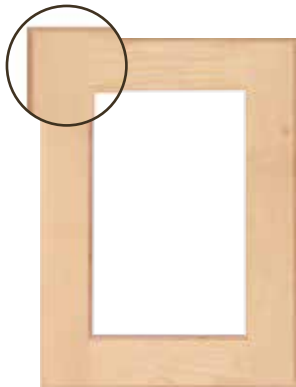

1 Lite/Frame Only

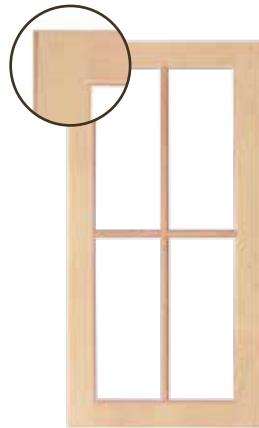

4 Lite

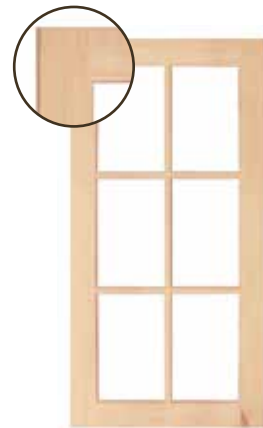

6 Lite

Wilmington Shaker Wood Mullion Doors

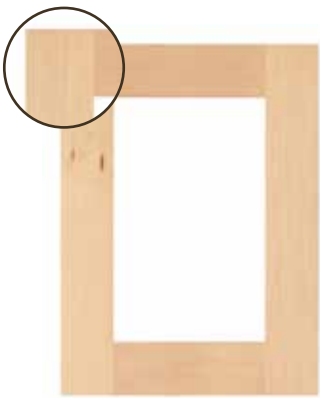

1 Lite/Frame Only

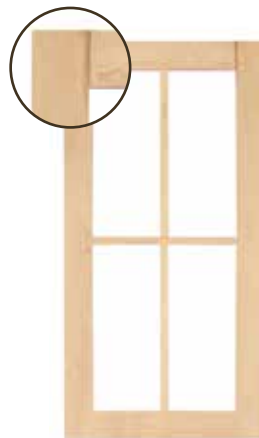

4 Lite



6 Lite

Wood Species



Red Oak



Hard Maple



Paint Grade Hard Maple



Cherry



Cabinet Doors

White RTF Mullion Cabinet Door Styles

Naples White RTF Mullion Cabinet Doors



1 Lite/Frame Only

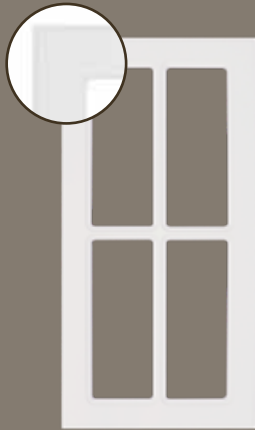

4 Lite

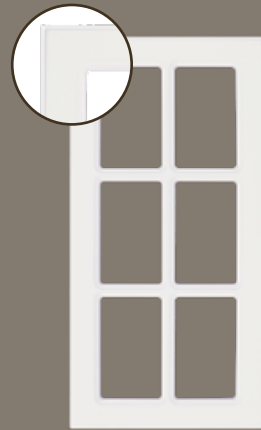

6 Lite

Naples Shaker White RTF Mullion Cabinet Doors

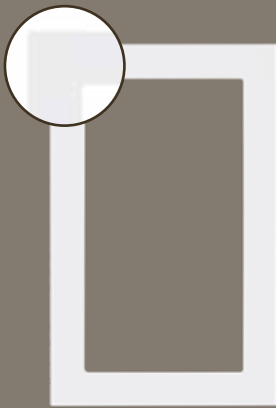

1 Lite/Frame Only

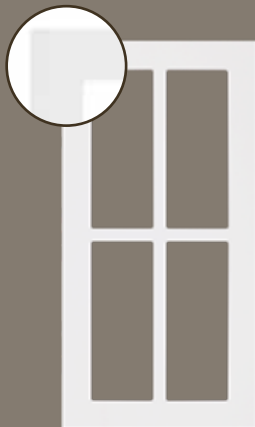

4 Lite

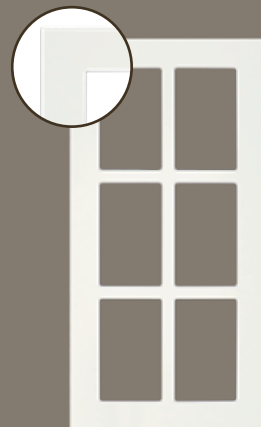

6 Lite



Drawer Fronts

Wood Drawer Front Styles

*Height and width available in 1/16" increments.
Minimum dimensions apply to each drawer front.*



Lancaster Veneer Slab*



Standard Slab
Fits all door styles



Shaker Slab



Wilmington
Recessed Flat Panel



Wilmington Shaker
Shaker Flat Panel



Asheville/Shelby/Concord
Raised Square Panel

**Richmond veneer slab is only available in hard maple and cherry*

**MDF available in Standard Slab, Shaker Slab, Wilmington, Wilmington Shaker, and Asheville/Shelby/Concord drawer fronts.*

Wood Species



Red Oak



Hard Maple



Paint Grade Hard Maple



Cherry



MDF



Drawer Fronts

White RTF Drawer Front Styles

*Height and width available in 1/16" increments.
Minimum dimensions apply to each drawer front.*

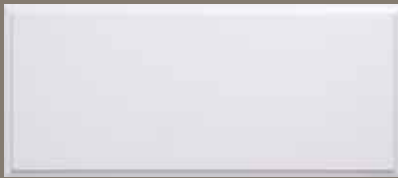

Naples
Slab Flat Panel



Naples Shaker
Shaker Flat Panel



Naples*
Rounded-Corner
Raised Panel

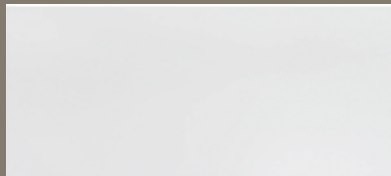

Venice Slab
Slab Flat Panel



Marathon*
Beaded Shaker Panel

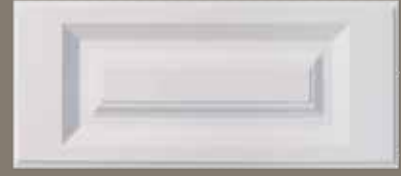

Daytona*
Square-Corner
Raised Panel

**available in Medium Density Fiberboard (MDF). MDF is for priming and painting only.*



Drawer Boxes

- $\frac{5}{8}$ " natural, solid birch side panels
- Height: Available from 2" to 12" in $\frac{1}{2}$ " increments
- Width: Available from 3" to 46" in $\frac{1}{16}$ " increments
- Depth: Available from 3" to 31" in $\frac{1}{16}$ " increments
- All drawer boxes are assembled prior to shipping

- Dovetail construction
- $\frac{1}{4}$ " plywood veneer bottom panel
- Finished sides, backs and bottom with clear UV finish
- Scoop handle pull for front of drawer box
- Notch and bore for undermount glides



Drawer Box Options

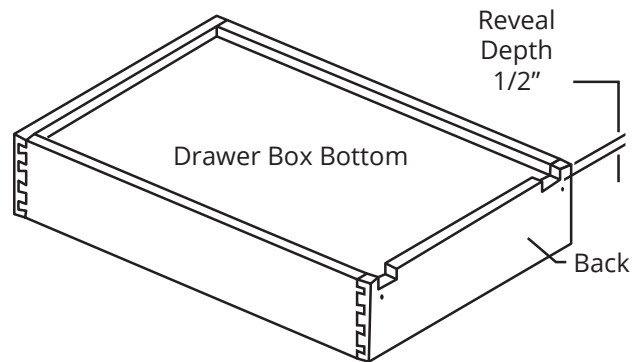
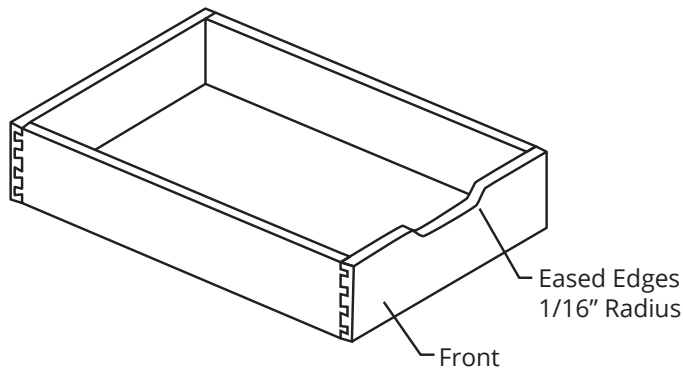

Scoop Hand Pull

- Minimum box width is 8"
- Hand pull is $5\frac{1}{4}$ " wide and $1\frac{11}{16}$ " deep, centered on front of drawer box.



Notch and Bore for Undermount Glides

- Minimum box width is 6"

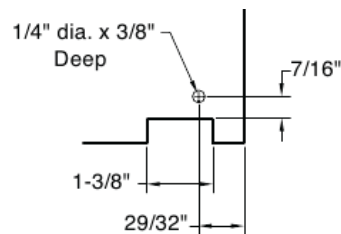

Undermount with hook hole boring



Assessory Selection

Veneers

*1/32" unfinished PSA poly back veneer.
Available only in 24" x 96" sheets.*



Base/ Wall End Panels

1/4" unfinished plywood panel with MDF core. End panels accept stains/finishes.

Available Sizes (wxh)

Base Panel: 24"x36"

Wall Panel: 12"x30"

Wall Panel: 12'x42"



Both veneers and end panels are available in the following species:



Red Oak



Hard Maple



Cherry

****Important: All Veneers and End Panels are non-returnable***



Cabinet Shelving

- 3/4" veneer plywood; Edgebanded on front side
- Veneer applied over veneer core with prefinished natural birch finish
- Does not include shelf clips
- Available for 9" to 48" wide base and wall cabinets
- Cut to size

Cabinet Shelving NEW



WALL CABINETS

Wall Cabinet Size	Shelf Size (W x D)
9"	7 7/16" x 10 1/2"
12"	10 7/16" x 10 1/2"
15"	13 7/16" x 10 1/2"
18"	16 7/16" x 10 1/2"
21"	19 7/16" x 10 1/2"
24"	22 7/16" x 10 1/2"
27"	25 7/16" x 10 1/2"
30"	28 7/16" x 10 1/2"
33"	31 7/16" x 10 1/2"
36"	34 7/16" x 10 1/2"
39"	37 7/16" x 10 1/2"
42"	40 7/16" x 10 1/2"
45"	43 7/16" x 10 1/2"
48"	46 7/16" x 10 1/2"

BASE CABINETS

Base Cabinet Size	Shelf Size (W x D)
9"	7 7/16" x 18"
12"	10 7/16" x 18"
15"	13 7/16" x 18"
18"	16 7/16" x 18"
21"	19 7/16" x 18"
24"	22 7/16" x 18"
27"	25 7/16" x 18"
30"	28 7/16" x 18"
33"	31 7/16" x 18"
36"	34 7/16" x 18"
39"	37 7/16" x 18"
42"	40 7/16" x 18"
45"	43 7/16" x 18"
48"	46 7/16" x 18"



CABINET DOORS 'N' MORE

For any questions please contact us at:

1-844-915-1150

info@cabinetdoorsnmore.com



cabinetdoorsnmore.com

