

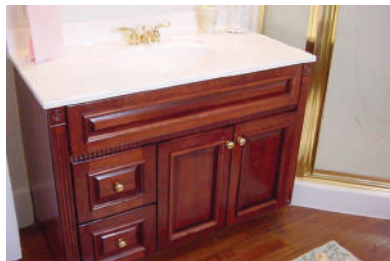

Kitchen



Bathroom



Basement

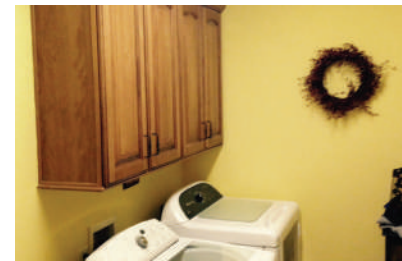

Laundry Room

# Replacement Cabinet Components

Cabinet Doors + Drawer Boxes + Drawer Fronts + Veneers + End Panels + Cabinet Shelving + Undermount Glides + Concealed Hinges



# Cabinet Doors

## Wood Cabinet Door Styles

Height and width available in 1/16" increments. Minimum dimensions apply to each door.



Lancaster Veneer Slab\*

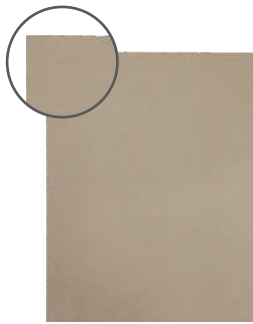

Lexington MDF Slab



Wilmington Shaker Shaker Flat Panel



Wilmington Recessed Flat Panel



Newton Shaker Shaker Flat Panel



Belmont Beaded Shaker Shaker Flat Panel



Asheville Square Raised Panel



Shelby Arched Raised Panel



Concord Cathedral Raised Panel

**\*NEW** - White primed cabinet doors now available for paint grade hard maple and MDF wood species. Allow 5 extra days lead time.

\*All flat panel doors have a 1/4" plywood veneer insert panel except for the paint grade hard maple wood species that features a 1/4" MDF insert panel. All raised panel doors feature a solid wood insert panel.

\*Richmond veneer slab is only available in hard maple and cherry

\*MDF doors for priming and painting only.

## Wood Species



Red Oak



Hard Maple



Paint Grade Hard Maple



Cherry

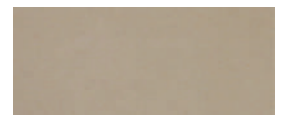

MDF

Lead time for product shipment is 10 business days from when the order is processed. Orders may ship from different manufacturing locations and arrive separately.



# Cabinet Doors

## Rigid Thermofoil Cabinet Door Styles (RTF=Rigid Thermofoil)



*Naples\**  
Rounded-Corner Raised Panel



*Naples\**  
Arch

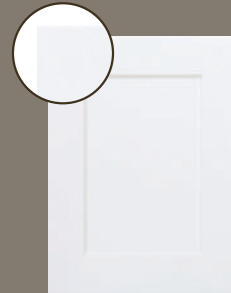

*Naples Shaker*  
Shaker Flat Panel



*Marathon Beaded Shaker\**  
Beaded Shaker Flat Panel

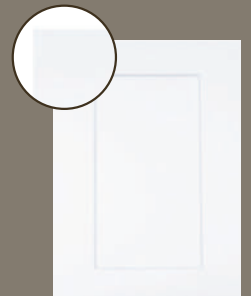

*Boca Shaker*  
Shaker Flat Panel

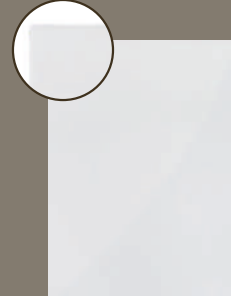

*Venice*  
Slab Flat Panel

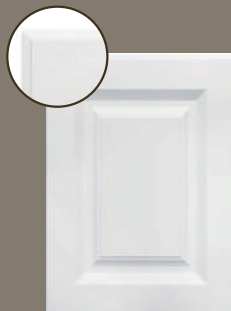

*Daytona\**  
Square-Corner Raised Panel

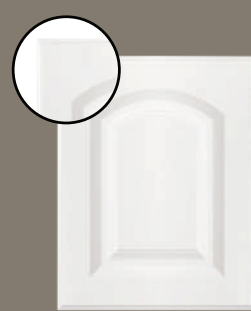

*Daytona\**  
Arch

## Color Options

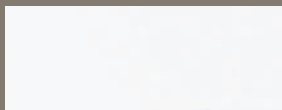

White

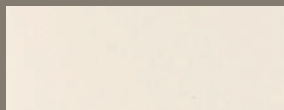

Antique White

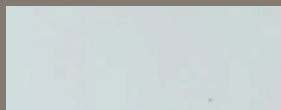

Stone Grey

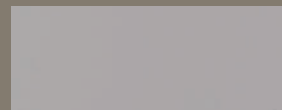

Smoke Grey

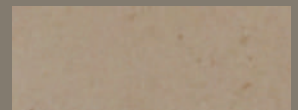

MDF

\*available in Medium Density Fiberboard (MDF). MDF is for priming and painting only.



# Cabinet Doors

## Wood Mullion Cabinet Door Styles

### *Wilmington Wood Mullion Doors*

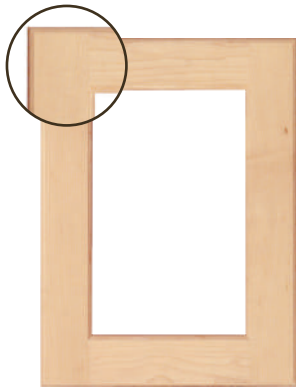

1 Lite/Frame Only

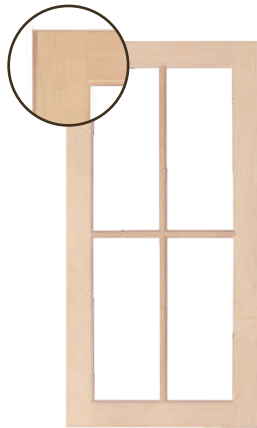

4 Lite



6 Lite

### *Wilmington Shaker Wood Mullion Doors*

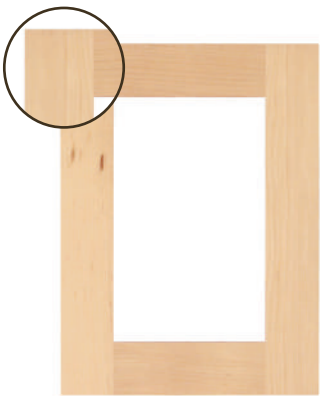

1 Lite/Frame Only

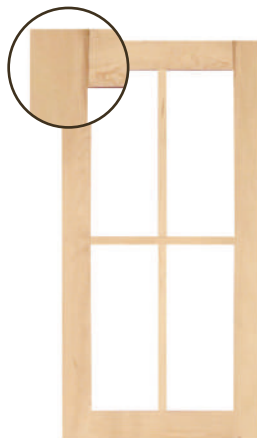

4 Lite

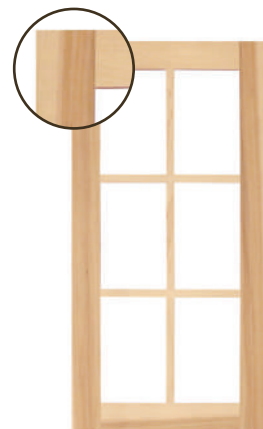

6 Lite

## Wood Species



*Red Oak*



*Hard Maple*



*Paint Grade Hard Maple*



*Cherry*





# Cabinet Doors

## Rigid Thermofoil Mullion Cabinet Door Styles

### *Naples White RTF Mullion Cabinet Doors*

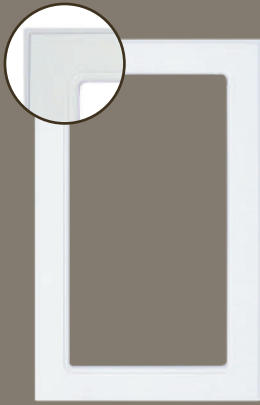

1 Lite/Frame Only

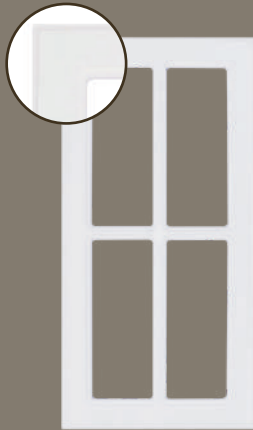

4 Lite

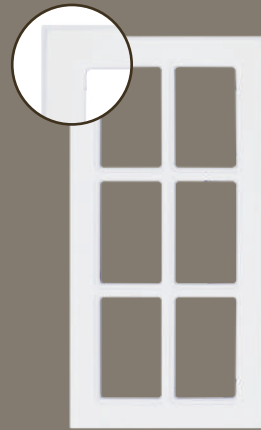

6 Lite

### *Naples Shaker White RTF Mullion Cabinet Doors*

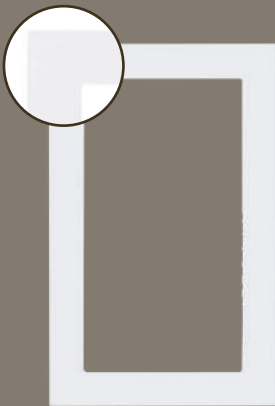

1 Lite/Frame Only

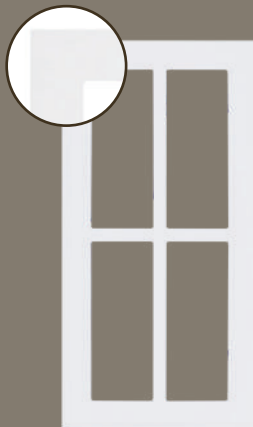

4 Lite

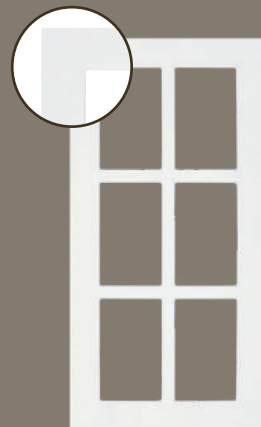

6 Lite

## Color Options

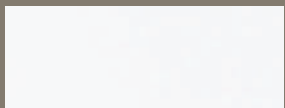

White

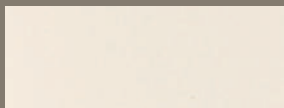

Antique White

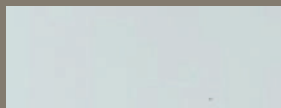

Stone Grey

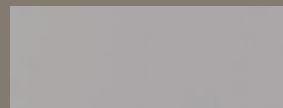

Smoke Grey

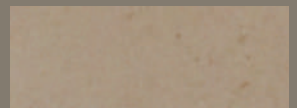

MDF

\*MDF is for priming and painting only.



# Drawer Fronts

## Wood Drawer Front Styles

Height and width available in 1/16" increments.  
Minimum dimensions apply to each drawer front.



**Lancaster Veneer Slab\***



**Standard Slab**  
Fits all door styles



**Shaker Slab**



**Newton Shaker**  
Shaker Flat Panel



**Wilmington**  
Recessed Flat Panel



**Wilmington Shaker**  
Shaker Flat Panel



**Asheville/Shelby/Concord**  
Raised Square Panel



**Belmont Shaker**  
Beaded Shaker Panel

*\*Richmond veneer slab is only available in hard maple and cherry*

*\*All flat panel doors have a 1/4" plywood veneer insert panel except for the paint grade hard maple wood species that features a 1/4" MDF insert panel. All raised panel doors feature a solid wood insert panel.*

## Wood Species



**Red Oak**



**Hard Maple**



**Paint Grade Hard Maple**



**Cherry**

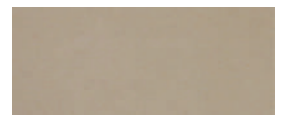

**MDF**



# Drawer Fronts

## Rigid Thermofoil Drawer Front Styles

*Height and width available in 1/16" increments.  
Minimum dimensions apply to each drawer front.*

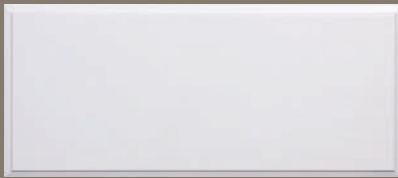

***Naples***  
Slab Flat Panel

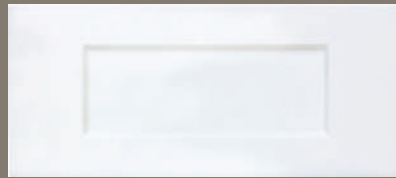

***Naples Shaker***  
Shaker Flat Panel

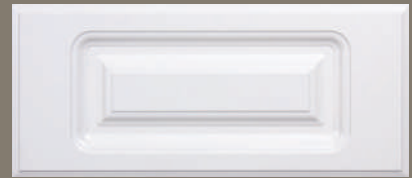

***Naples***  
Rounded-Corner  
Raised Panel

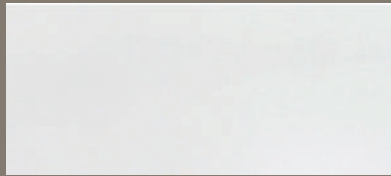

***Venice Slab***  
Slab Flat Panel



***Marathon***  
Beaded Shaker Panel

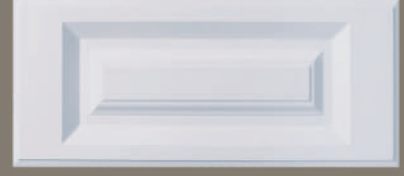

***Daytona***  
Square-Corner  
Raised Panel

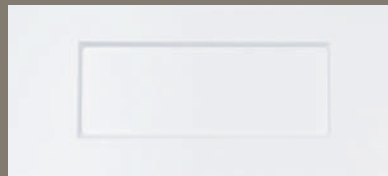

***Boca Shaker***  
Shaker Flat Panel

## Color Options

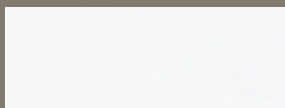

White

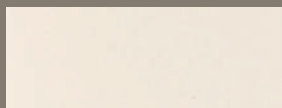

Antique White

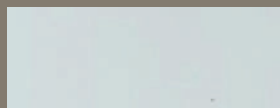

Stone Grey

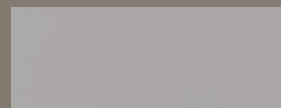

Smoke Grey

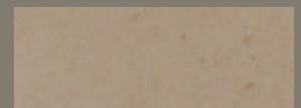

MDF

\*MDF is for priming and painting only.



# Drawer Boxes

- $\frac{5}{8}$ " side panels
- Height: Available from 2" to 12" in  $\frac{1}{2}$ " increments
- Width: Available from 3" to 46" in  $\frac{1}{16}$ " increments
- Depth: Available from 3" to 31" in  $\frac{1}{16}$ " increments
- All drawer boxes are assembled prior to shipping

- Dovetail construction
- $\frac{1}{4}$ " plywood veneer bottom panel
- Finished sides, backs and bottom with clear UV finish
- Scoop handle pull for front of drawer box
- Notch and bore for undermount glides



Natural Birch



Premium Maple

## Drawer Box Options

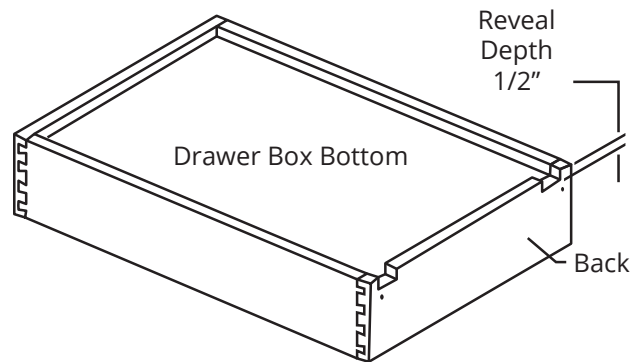
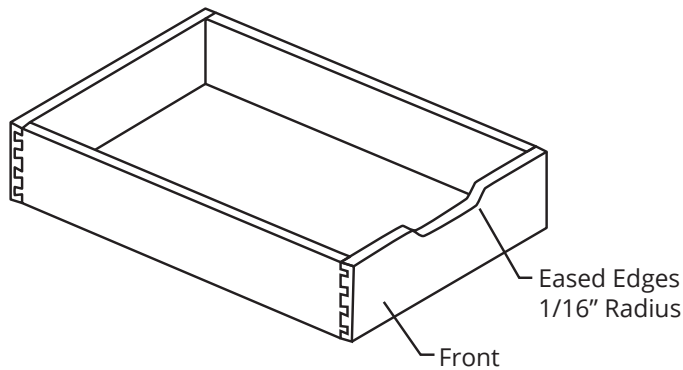

## Scoop Hand Pull

- Minimum box width is 8"
- Hand pull is  $5\frac{1}{4}$ " wide and  $1\frac{1}{16}$ " deep, centered on front of drawer box.



## Notch and Bore for Undermount Glides

- Minimum box width is 6"

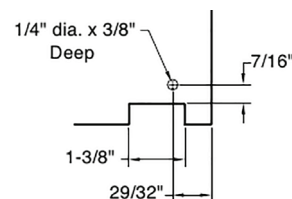

Undermount with hook hole boring







# Assessory Selection

## Veneers

*1/32" unfinished PSA poly back veneer.  
Available only in 24" x 96" sheets.*



## Base/ Wall End Panels

*1/4" unfinished plywood panel with MDF core. End panels accept stains/finishes.*

**Available Sizes (wxh)**

**Base Panel: 24"x36"**

**W 42"**



*Both veneers and end panels are available in the following species:*



*Red Oak*



*Hard Maple*



*Cherry*

***\*Important: All Veneers and End Panels are non-returnable***



# Cabinet Shelving

- ¾" veneer plywood; Edgebanded on front side
- Veneer applied over veneer core with prefinished natural birch finish
- Does not include shelf clips
- Available for 9" to 48" wide base and wall cabinets
- Cut to size

## Cabinet Shelving NEW



### WALL CABINETS

Wall Cabinet Size	Shelf Size (W x D)
9"	7 7/16" x 10 1/2"
12"	10 7/16" x 10 1/2"
15"	13 7/16" x 10 1/2"
18"	16 7/16" x 10 1/2"
21"	19 7/16" x 10 1/2"
24"	22 7/16" x 10 1/2"
27"	25 7/16" x 10 1/2"
30"	28 7/16" x 10 1/2"
33"	31 7/16" x 10 1/2"
36"	34 7/16" x 10 1/2"
39"	37 7/16" x 10 1/2"
42"	40 7/16" x 10 1/2"
45"	43 7/16" x 10 1/2"
48"	46 7/16" x 10 1/2"

### BASE CABINETS

Base Cabinet Size	Shelf Size (W x D)
9"	7 7/16" x 18"
12"	10 7/16" x 18"
15"	13 7/16" x 18"
18"	16 7/16" x 18"
21"	19 7/16" x 18"
24"	22 7/16" x 18"
27"	25 7/16" x 18"
30"	28 7/16" x 18"
33"	31 7/16" x 18"
36"	34 7/16" x 18"
39"	37 7/16" x 18"
42"	40 7/16" x 18"
45"	43 7/16" x 18"
48"	46 7/16" x 18"



# Accessories

## BLUM UNDERMOUNT SOFT-CLOSE CABINET DRAWER GLIDES

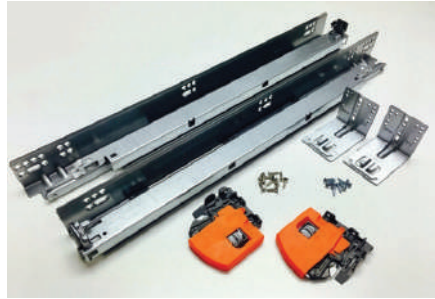

### FEATURES:

- Full extension concealed soft-close drawer glides
- For face frame or panel cabinets
- BLUMOTION self-closing glides
- TANDEM smooth opening/closing action
- Available in 15", 18" and 21" lengths
- Two Side Adjustable locking devices for side to side adjustments
- Two rear mounting brackets for face frame cabinets
- Notch and Bore drawer box option required
- For use with drawer thickness of 1/2" to 5/8"
- 1/2" bottom reveal required
- 100 lb. load capacity
- Made in the USA

## CABINET DOOR HINGES

### Economy Self-Closing Hinges

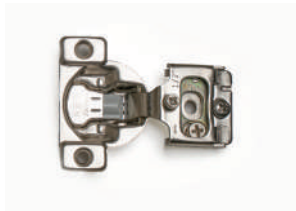

*1/2" Overlay*

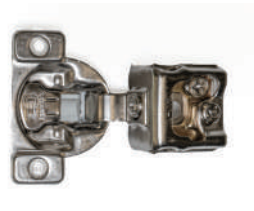

*1 1/4" Overlay*

### FEATURES:

- Steel self-closing concealed hinges for use with 3/4" thick components
- Available in 1/2" and 1 1/4" overlays
- Packaged as pairs with mounting screws and instructions
- Soft close featured built into hinge cup
- Wrap around face frame mounting for ease of installation
- 1/2" overlay - 105 degree opening angle
- 1 1/4" overlay - 110 degree opening angle
- Fits 35mm cup diameter ( 1/2" cup depth)
- Easy adjustments for door spacing

## BLUM BLUMOTION SOFT-CLOSE-HINGES



*1/2" Overlay*



*1 1/4" Overlay*

### FEATURES:

- One-piece nickel plated steel self-closing concealed hinges for use with 3/4" thick components
- Packaged as pairs with mounting screws and instructions
- BLUMOTION Soft close feature integrated into hinge cup
- Soft close feature can be deactivated with a switch depending on door size and weight
- Wrap around face frame mounting for ease of installation
- Three dimension adjustment feature side, height and depth adjustment for fine tuning door spacing
- 1/2" overlay - 105 degree opening angle
- 1 1/4" overlay - 110 degree opening angle
- Fits 35mm cup diameter (1/2" cup depth)



# CABINET DOORS 'N' MORE

For any questions please contact us at:

1-844-915-1150

[info@cabinetdoorsnmore.com](mailto:info@cabinetdoorsnmore.com)



[cabinetdoorsnmore.com](http://cabinetdoorsnmore.com)

