

Hugi B1598 Basin

Notes:

- Freestanding
- Polymarble or solid surface composition
- 10 years manufacturers warranty

Finishes:

- Matte white
- Gloss white
- Full colour range

Options:

Stone waste
(matte white)

Size: 450 L x 450 W x 850 H (mm)

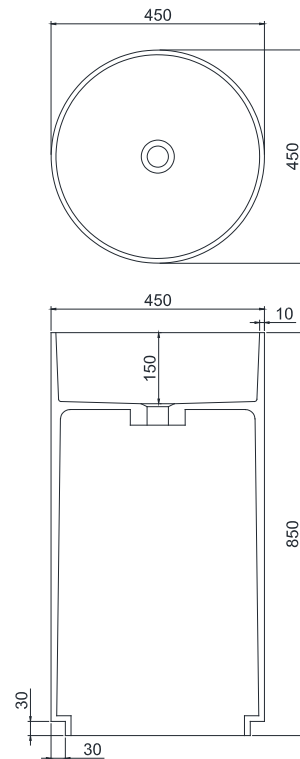

Net weight: 37kg
Gross weight: 62kg
Unit: mm