

B1594 500mm Basin

Notes:

- Freestanding
- Polymarble or solid surface composition
- 10 years manufacturers warranty

Finishes:

- Matte white
- Gloss white
- Full colour range

Options:

Stone waste
(matte white)

Size: 500 L x 500 W x 885 H (mm)

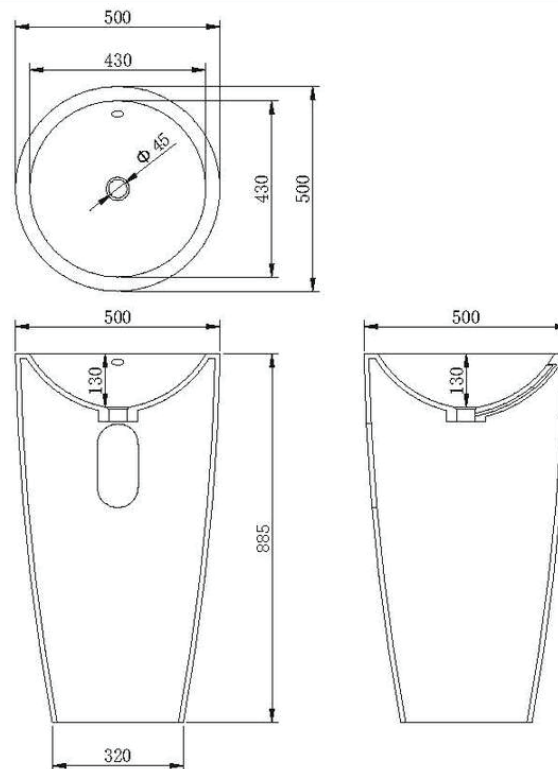

Net weight: 45kg
Gross weight: 75kg
Unit: mm