

KELE

AUSTRALIA
Phone: 1800 462 946
Email: info@stonebaths.com.au
Web www.stonebaths.com.au

NEW ZEALAND
Phone: 0800 001 872
Email: info@stonebaths.co.nz
Web www.stonebaths.com.au

 **stonebaths**
Industry leaders since 2004

FUJISAN 1000mm Freestanding Bath Kfsfujj 1000

Notes:

- Gloss white
- Sanitary grade acrylic
- With feet
- 10 year manufacturers warranty

Size: 1000 x 700 x 510/630

Finishes:

- Gloss white
- Colour
- Matt white outer

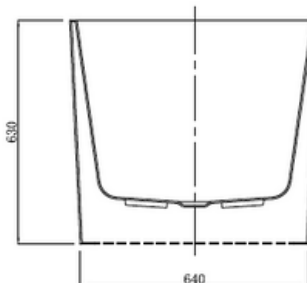
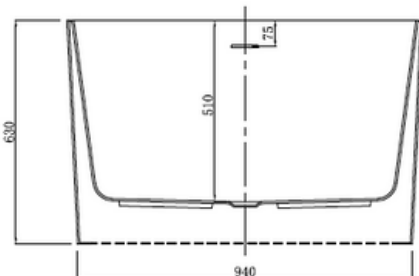
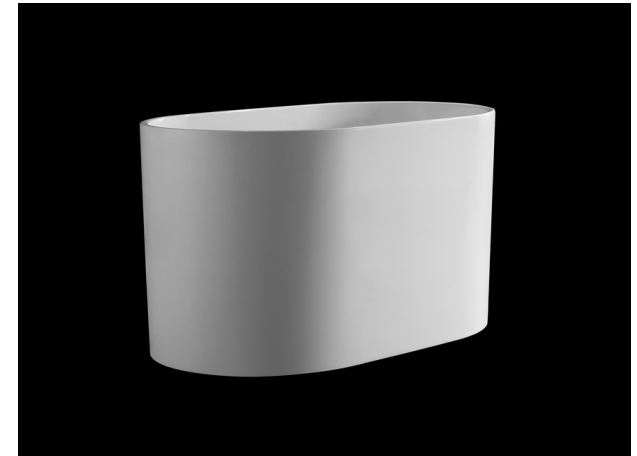
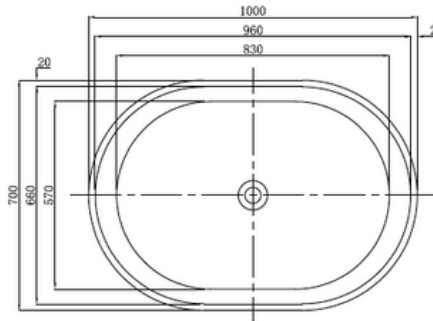

Net Weight: <70kg
Gross Weight: <100kg
Water capacity: