

B037-A 1810mm Freestanding Bath

Notes:

- Freestanding bathtub
- Polymarble or solid surface composition
- Matte white
- Chrome waste
- Optional matching stone waste available
- 10 years manufacturers warranty

Finishes:

- Matte white
- Gloss white
- Full colour range

Options:

- Overflow
- Non-overflow
- Stone waste

Size: 1810L x 800W x 570H (mm)

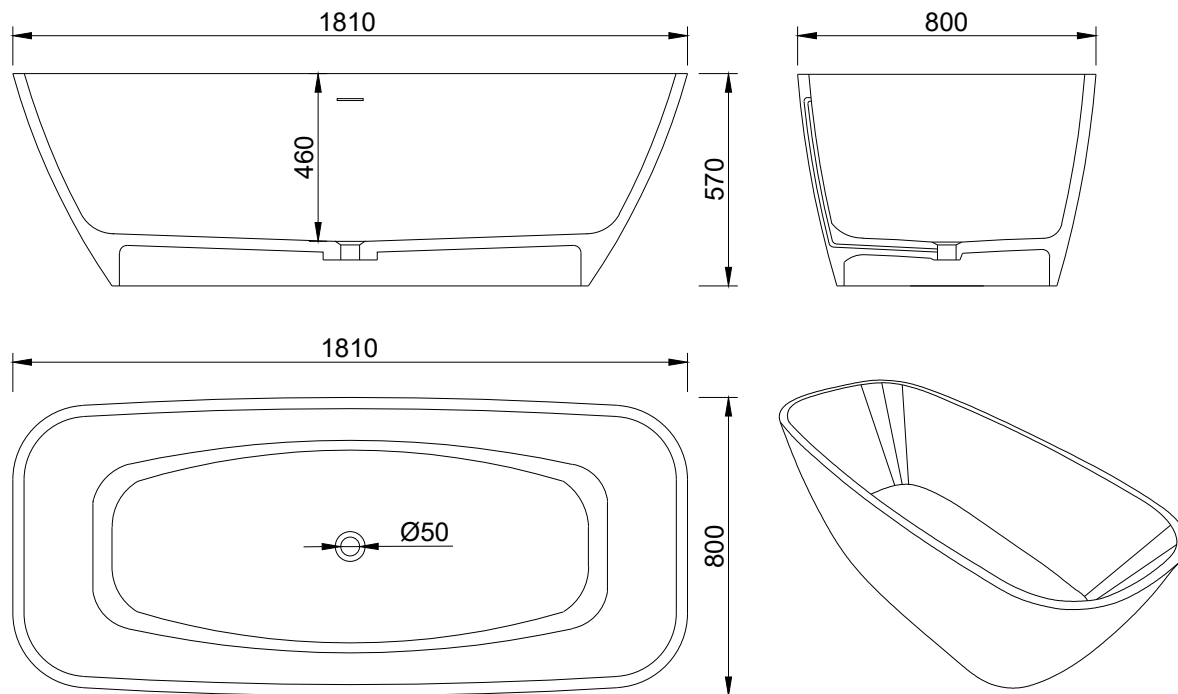

Net weight: 208 kg
Gross weight: 282kg
Water Capacity: 385lt
Unit: mm