



2024 PRODUCT CATALOG

DiamondCore® Tools. Effective 11/1/2023.
Prices shown are in U.S. dollars and subject
to change without prior written notice.

Contents

Pottery Multi-Tool and Folding-Blade Tools	3
Carving Tools	7
Carving Tools/Classic.....	8
Palm Carvers.....	9
Carving Tools/Classic.....	10
Carving Tools/Relief.....	13
Carving Tools/Fine Point.....	14
Carving Tools/Fluting.....	17
Carving Tools/K Handle.....	20
Diamond Stylus Tools	21
Trimming Tools	23
Diamond Sets	28
Handheld Clay Extruders	29
Diamond Tools	35
Diamond Grinding Discs.....	36
Diamond Sanding.....	37
Circular Diamond Pads/Sanding Blocks.....	39
Diamond Rotary Tools.....	40
Micro Rotary/Polishing Paste/Cut-Off Wheel.....	43
Hole Drills.....	44
Spiral Bands.....	46
Sticky Products	47
The CINK	49
Wood and Metal Ribs	51
Additional Products	53
Safety Precautions	58



ABOUT US

At DiamondCore® Tools, we've been on a mission to change the world of ceramic arts since 1996. We create innovative, high-quality, hand-crafted tools that are essential for anyone working with ceramics, glass, tile, stone, wax and other materials.

Our products include:

- Carving tools
- Diamond stylus tools
- Trimming tools
- Handheld clay extruders
- Diamond grinding and sanding tools
- Sticky bats and pads
- The CINK mobile clay water recycling system
- And more!

Our high-performance tools let artists do things they never could have imagined before – faster and easier. Our blades are thinner, sharper and more durable than others on the market, giving you crisper lines, more intricate designs, less fatigue and better overall results. From the original P1 Carving Tool to the Bird of Paradise Pottery Multi-Tool, our products help customers take their projects to the next level.



Pottery Multi-Tool and Folding-Blade Tools

DiamondCore® Tools changes the world of ceramic arts again with our one-of-a-kind Bird of Paradise Pottery Multi-Tool and sleek, folding-blade tools.

The Bird of Paradise Pottery Multi-Tool is expertly designed to boost your productivity. It features a stainless-steel Pottery Knife, Needle Tool, Scoring Tool, Precision Blade, Cutting Guide, Mini-Wrench and #1 Phillips Screwdriver all in a stylish hardwood and steel handle. Use it to help join pieces of clay, cut edges at a precise distance or angle, tighten the hardware on your existing DiamondCore® tools and more.

Single, folding-blade versions of the Pottery Knife, Needle Tool, Scoring Tool and Mini-Wrench Screwdriver are also available, all built with hardwood and stainless-steel components.

Practical and economical, these tools also feature replaceable blades and inserts should you bend or otherwise damage them.

BIRD OF PARADISE POTTERY MULTI-TOOL

\$108



MT1 Bird of Paradise Pottery Multi-Tool



WARNING!
Sharp Objects

Multi-Tool Parts

No.	Description
1	Handle side 1
2	Handle side 2
3	Frame
4	Thumb Screw
5	Mini-Wrench/cutting guide
6	Precision Blade
7	Washers
8	Pottery Knife
9	Phillips Screwdriver
10	Needle Tool
11	Scoring Tool
12	Barrel w/flat sides
13	Barrels
14	Screws

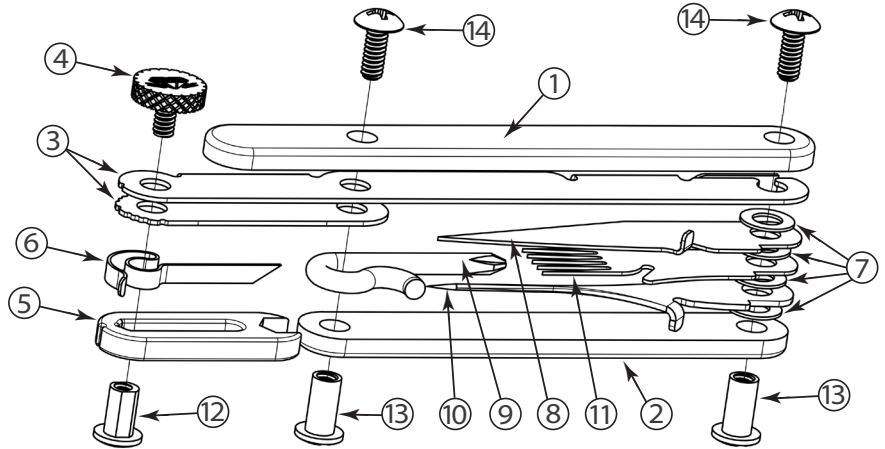

FOLDING-BLADE TOOLS



~~\$26~~

MTK
Pottery Knife



~~\$26~~

MTS
Scoring Tool



~~\$18~~

MTW
Mini-Wrench
Screwdriver



~~\$26~~

MTN
Needle Tool



Carving Tools

Ready to add unique designs and intricate details to your ceramic creations? DiamondCore® carving tools are handmade and feature a comfortable foam grip and advanced blade technology.

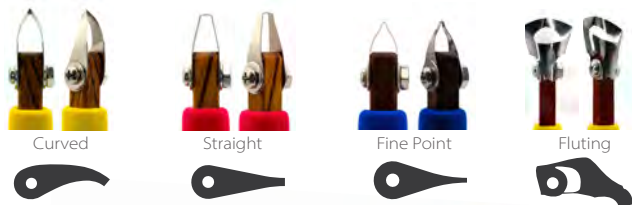

Curved

Straight

Fine Point

Fluting

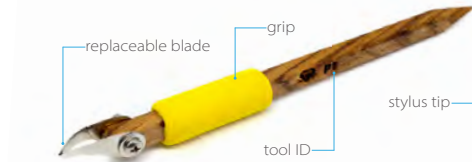

Most carving tools come with a stylus tip, colored foam grip and a hardwood handle.



P1



P2



P3



P4
Teardrop
Fluting Tool



P4V
Fluting
Tool



P5



P6L
Hook Tip
(left-handed)
(fine line carving)



P6R
Hook Tip
(right-handed)
(fine line carving)



P7



\$38

PALM CARVERS



P8S



P8U



P8V



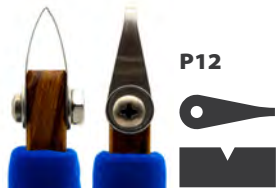

\$38

CARVING TOOLS/Classic







P26
Long Diamond
Relief Carver



P27
Straight Slope
Relief Carver



P28
Candle Flame
Relief Carver



P29
Round Slope
Relief Carver





FP1

U Tip 1 mm

(extra blade and grip included)



FP2

Arrow

(extra blade and grip included)



FP3

U Tip 3 mm

(extra blade and grip included)



\$38

CARVING TOOLS/Fine Point



FP4
Javelin
(extra blade and grip included)



FP5
U Tip 5 mm
(extra blade and grip included)



FP6
Ballpoint
(extra blade and grip included)





FP7

Arc Chisel

(extra blade and grip included)



3.5 mm



FP8

Flat Chisel

(extra blade and grip included)



3.5 mm



FP9

Micro Half Dome

(extra blade and grip included)



5 mm



\$42

CARVING TOOLS/Fluting



X1
12 mm V
(extra blade included)

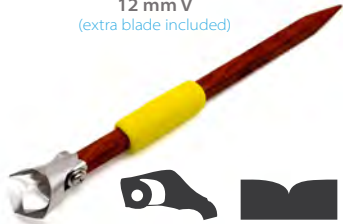

X2
12 mm U
(extra blade included)

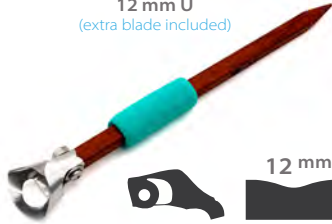

X3
3 mm Square
(extra blade included)





X4

1 mm Square
(extra blade included)



1 mm



X5

3 mm U
(extra blade included)



3 mm



X6

12 mm VU
(extra blade included)



12 mm



X7
6 mm Square
(extra blade included)



X8
Double U
(extra blade included)



X9
Double V
(extra blade included)



CARVING TOOLS/K Handle





Diamond Stylus Tools

To create the finest sgraffito detailing, you need DiamondCore® diamond stylus tools. These durable, pencil-like sgraffito tools have diamond stylus tips on both ends, providing a variety of intricate etching and detailing options for your bone dry works of art.



Each L series diamond stylus tool comes with two unique tips, two colored foam grips and a hardwood handle.

I love this stylus (L3 Diamond Sgraffito Stylus Tool - Small Football/Large Football). It is easy to use, very easy to master, and built to last. When creating sgraffito, it is my go-to.

— Betty



L1
Diamond Stylus
Needle/1 mm Ball



L2
Diamond Stylus
0.7 mm Ball/2 mm Crown



L3
Diamond Stylus
Small Football/Large Football





Trimming Tools

Ready to refine your form or shape your bottom? Reach for Diamond-Core® trimming tools with replaceable, never-dull, stainless-steel blades. These trimming tools can handle clay too wet or too dry for other tools and provide minimal drag.



My first DiamondCore trimming tool! I love it! I have trimmed 30 items with it. It is sharp, easy to use, trim my pots and bowls super smooth. I love that one side is square and one side is rounded because I can switch it around and use each side depending on what I am doing. And it comes with an extra blade! Very good tool for the value!

— Jenn



T1
Half Dome Blade
w/Paddle Handle
(extra blade included)



T2
Arc Blade
w/Cone Handle
(extra blade included)



T3
Slanted Square Blade
w/Square-Tipped Handle
(extra blade included)



T4
U Tip Blade
w/Rounded Handle
(extra blade included)



T5
Torch Blade
w/Talon Handle
(extra blade included)



T6
Spade Blade
w/Boat Handle
(extra blade included)



T7
Avocado Blade
w/Flat Round Handle
(extra blade included)



T8
Wedge Blade
w/Flat Head Handle
(extra blade included)



T9
Shark Fin Blade
w/Shark Tooth Handle
(extra blade included)



T10
Volcano Blade
w/U Shaped Rim
Smoother Handle
(extra blade included)



T11
Starfish Blade
w/Triangle Tip Handle
(extra blade included)



T12
Ballpoint Blade
w/Ballpoint Handle
(extra blade included)

TRIMMING TOOLS





\$46

T301
Triangle Feature
w/Small Paddle Handle



\$46

T302
Square Feature
w/Small Paddle Handle



\$46

T303
Round Feature
w/Small Paddle Handle



\$46

T304
Asymmetrical Triangle Feature
w/Small Paddle Handle



DIAMOND SETS



T Series Diamond Set shown



3-piece finger
brush set
included with all
diamond sets

~~---~~ \$998 ~~---~~

DPT
P Series
Diamond Set
(36 pieces)

~~---~~ \$298 ~~---~~

DFP
FP Series
Diamond Set
(12 pieces)

~~---~~ \$329 ~~---~~

DXT
X Series
Diamond Set
(12 pieces)

~~---~~ \$1,348 ~~---~~

DRT
R Series
Diamond Set
(36 pieces)

~~---~~ \$898 ~~---~~

DTT
T Series
Diamond Set
(27 pieces)



Handheld Clay Extruders

R Series Handheld Clay Extruders quickly create clean and beautiful accents for your ceramic pieces. Use the tool's variable depth ski and DiamondCore® Tools advanced blade technology to produce feet for slab-built platters, dishes or plates, as well as handles for mugs, pitchers and other vessels.

Use on clay slabs that are the same dryness as you would use to pull a handle. If too wet, the extrusion may stick on the slab.

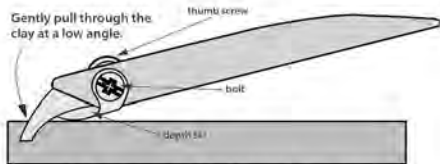
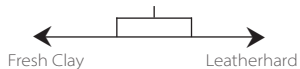

Loosen the thumb screw and adjust the depth ski up or down to the desired thickness and then re-tighten the thumb screw.



adjustable thickness



R1
Trapezoid



R2
Triangle



R3
U Shape



R4
Concave



R5
Middle Ridge



R6
Oval



R7
Single Groove

\$52

HANDHELD CLAY EXTRUDERS



R8
Double Line



R9
Double Round



R10
Triple Round



R11
Cloud



R12
Koala



R13
Narrow Trapezoid



R14
Square



R15
Ribbon



R16
Double Concave



R17
Chocolate Kiss



R18
Ruffle



R101
Concave XS



R102
Koala XS



R103
Double Round XS

\$52

HANDHELD CLAY EXTRUDERS



R201
Sunrise XL



R202
Belt Strap XL



R203
Frog XL



R204
Concave XL



R205
Middle Ridge XL



R206
Oval XL



R207
Koala XL



R208
Triple Round XL



R209
Double Round XL



R210
Trapezoid Wall XL



R211
Round Trapezoid Wall XL



R212
Tall Triangle Wall XL



Diamond Tools

Get a smoother finished product with our diamond sanding discs and pads for pottery. Solid diamond composites increase longevity of the rotary bits and hole drills. Our diamond tools are extremely durable, reduce fatigue and allow you to work faster with ease.

GRIT #	BEST FOR
< 100 #	material removal/coarse finish
100 series #	material removal/medium finish
200 series #	smoothing/fine finish
400 series #	smoothing/extra-fine finish
800 series #	smoothing/super-fine finish
> 1000 #	smoothing/ultra-fine finish
FLEXIBILITY	
ultra flexible	M paper
flexible	B pads
semi flexible	A pads/C strips
semi rigid	VB pads
max rigid	HB blocks

DIAMOND SANDING

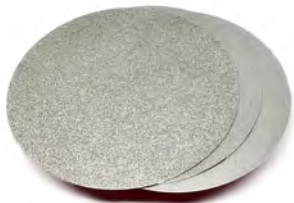

\$59 ea.

F1 60# (coarse)
F3 120# (medium)
F4 240# (fine)
200 mm (~8") disc with peel-and-stick adhesive on back

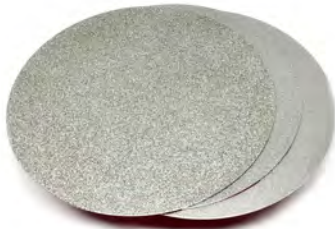

\$126 ea.

G1 60# (coarse)
G3 120# (medium)
G4 240# (fine)
300 mm (~12") disc with peel-and-stick adhesive on back

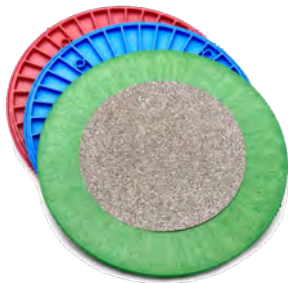

\$75 ea.

F11 60# (coarse)
F13 120# (medium)
F14 240# (fine)
200 mm (~8") disc on
300 mm (~12") bat

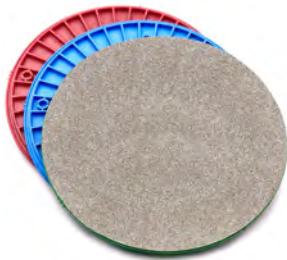

\$142 ea.

G11 60# (coarse)
G13 120# (medium)
G14 240# (fine)
300 mm (~12") disc on
300 mm (~12") bat



- B1** 60# (coarse)
 - B2** 120# (medium)
 - B3** 240# (fine)
 - B4** 400# (extra fine)
 - B5** 800# (super fine)
 - B6** 1500# (ultra fine)
- 64 mm (~2½") square
Flexible Diamond Pads
(rounded corners)



- M2** 120# (medium)
 - M3** 200# (fine)
 - M4** 400# (extra fine)
 - M5** 800# (super fine)
 - M6** 1500# (ultra fine)
- 64 mm x 100 mm
(~2½" x ~4")
Diamond Sandpaper



- C1** 60# (coarse)
 - C2** 120# (medium)
 - C3** 200# (fine)
 - C4** 400# (extra fine)
 - C5** 800# (super fine)
- 20 mm x 160 mm
(~¾" x ~6¼")
Flexible Diamond
Sanding Strips



- B7** 60# (coarse)
 - B8** 120# (medium)
 - B9** 200# (fine)
 - B10** 400# (extra fine)
 - B11** 800# (super fine)
 - B12** 1500# (ultra fine)
- 64 mm (~2½") square
Flexible Diamond Pads
(squared corners)



- M12** 120# (medium)
 - M13** 200# (medium fine)
 - M14** 400# (fine)
 - M15** 800# (ultra fine)
 - M16** 1500# (ultra fine)
- 216 mm x 280 mm
(~8½" x ~11")
Diamond Sandpaper

DIAMOND SANDING



J11 60# (coarse)
120# (medium)



J12 200# (fine)
400# (extra fine)
6.25" x .25"
Diamond Files

\$16 ea.



A1 60# (coarse)
A2 120# (medium)
A3 240# (fine)
45 mm x 70 mm
(~1¾" x ~2¾")
Semi-Flex
Diamond Pad

\$19 ea.



\$22 ea.

VB-1
60# Hook-
and-Loop Pad
(coarse)

VB-4
400# Hook-
and-Loop Pad
(extra fine)

VB-7
3000# Hook-
and-Loop Pad
(ultra fine)

VB-2
120# Hook-
and-Loop Pad
(medium)

VB-5
800# Hook-
and-Loop Pad
(super fine)

VB-3
200# Hook-
and-Loop Pad
(fine)

VB-6
1500# Hook-
and-Loop Pad
(ultra fine)



\$12 BLOCK ONLY

VB
Block for
Hook-and-
Loop Pad(s)
(pad not included)

CIRCULAR DIAMOND PADS/SANDING BLOCKS

Flexible Circular Diamond Pads hook-and-loop backed/127 mm (5") round

~~-\$29 ea.~~

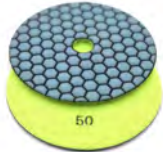

CP1

50# (coarse)

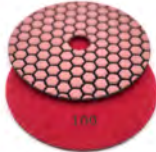

CP2

100# (medium)

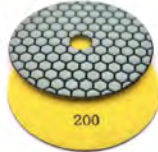

CP3

200# (fine)

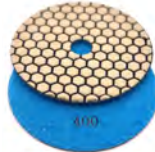

CP4

400# (extra fine)

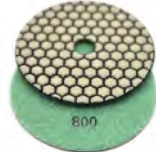

CP5

800# (super fine)



CP6

1500# (ultra fine)



CP7

3000# (ultra fine)

Diamond Sanding Blocks 50 mm x 100 mm (2" x 4")

~~-\$28 ea.~~

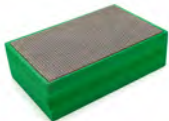

HB-1

60# (coarse)



HB-2

120# (medium)



HB-3

220# (fine)



HB-4

400# (extra fine)

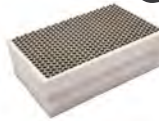

HB-5

800# (super fine)

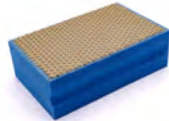

HB-18

1800# (ultra fine)

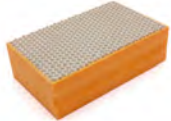

HB-7

3500# (ultra fine)

DIAMOND ROTARY TOOLS



E1
Diamond Rubber
Polisher Bullet Set
2.3 mm shaft
(9-piece set)

~~\$25~~



0.8 mm (1/32") 1.6 mm (1/16") 2.4 mm (3/32") 3.2 mm (1/8")
collet nut

~~\$14~~

DCS
Dremel® Collet Set
(5-piece set)



60#
(coarse)



120#
(medium)



240#
(fine)



400#
(extra fine)



800#
(super fine)



1,500#
(ultra fine)



3,000#
(ultra fine)



Adapter
3 mm shaft



G40 40#
Silicon Carbide Grinding Disc
w/peel-and-stick adhesive on back
(300 mm (~12") coarse)

~~\$16~~



G80 80#
Silicon Carbide Grinding Disc
w/peel-and-stick adhesive on back
(300 mm (~12") coarse)

~~\$16~~

~~\$39~~

E2
25 mm (~1")
Mini Circular
Diamond Pad Set
(8-piece
hook-and-loop set)

\$18

DIAMOND ROTARY TOOLS



D1
Bullet, 3 mm shaft
80# (coarse)



D2
Bullet, 3 mm shaft
170# (medium)



D3
Cone, 3 mm shaft
170# (medium)



D5
Cylinder, 3 mm shaft
80# (coarse)

*rotary tools
for use with
cordless Dremel®*



D6
Dome, 3 mm shaft
80# (coarse)



D7
Dome, 3 mm shaft
170# (medium)



D10
Round, 3 mm shaft
170# (medium)



D11
Slim Cone, 3 mm shaft
80# (coarse)



D12
Slim Cone, 3 mm shaft
170# (fine)



D13
Inverted Cone, 3 mm shaft
100# (medium)

rotary tools
for use with
cordless Dremel®



D14
Inverted Cone, 3 mm shaft
170# (fine)



D15
Round End Taper, 3 mm shaft
100# (medium)



D16
Round End Taper, 3 mm shaft
170# (fine)



D17
Sharp Flame, 3 mm shaft
100# (medium)



D18
Sharp Flame, 3 mm shaft
170# (fine)



D19
Tapered Inverted Cone, 3 mm shaft
100# (medium)



D20
Drum Shape, 3 mm shaft
100# (medium)

~~\$24~~



D21
Ball End, 3 mm shaft
600# (fine)



D22
Bead Reamer,
3 mm shaft
47 mm long needle
(rough grit)



\$32

CW
Diamond Cut-Off Wheel
with Mandrel, 3 mm shaft
(6-piece set: 5 wheels,
1 mandrel w/3 mm shaft)

\$48 ea.

Diamond
Polishing Paste

micro rotary
for use with
cordless Dremel®

\$28



D101
Micro Rotary
Round End Taper
1.6 mm shaft

\$28



D102
Micro Rotary
Flat End Taper
1.6 mm shaft

\$28



D103
Micro Rotary
Football
1.6 mm shaft

\$48



D111
Micro Rotary
Large Cylinder
2.3 mm shaft



SKU	GRIT	Price
Paste 400	400#	\$48
Paste 600	600#	\$48
Paste 800	800#	\$48
Paste 1000	1000#	\$48
Paste 1200	1200#	\$48
Paste 2000	2000#	\$48
Paste 3000	3000#	\$48
Paste 8000	8000#	\$48

HOLE DRILLS



Tool	SKU	Price	Tool	SKU	Price	Tool	SKU	Price	Tool	SKU	Price	Tool	SKU	Price
H3	3mm	\$28	H11	11mm	\$32	H19	19mm	\$40	H32	32mm	\$60	H70	70mm	\$128
H4	4mm	\$28	H12	12mm	\$32	H20	20mm	\$40	H35	35mm	\$64	H75	75mm	\$138
H5	5mm	\$28	H13	13mm	\$32	H21	21mm	\$42	H40	40mm	\$72	H80	80mm	\$148
H6	6mm	\$30	H14	14mm	\$32	H22	22mm	\$42	H45	45mm	\$86	H85	85mm	\$158
H7	7mm	\$30	H15	15mm	\$34	H23	23mm	\$44	H50	50mm	\$92	H90	90mm	\$168
H8	8mm	\$30	H16	16mm	\$34	H24	24mm	\$44	H55	55mm	\$98	H95	95mm	\$178
H9	9mm	\$32	H17	17mm	\$36	H25	25mm	\$48	H60	60mm	\$108	H100	100mm	\$198
H10	10mm	\$32	H18	18mm	\$36	H30	30mm	\$54	H65	65mm	\$118			

SPIRAL BANDS



SB1

Small Spiral Band
(60#)

~~\$32~~



SB2

Small Spiral Band
(120#)

~~\$32~~



SB3

Small Spiral Band
(200#)

~~\$32~~



SB11

Large Spiral Band
(60#)

~~\$38~~



SB12

Large Spiral Band
(120#)

~~\$38~~



SB13

Large Spiral Band
(200#)

~~\$38~~



SBM19

Small Spiral Band
Rubber Mandrel
(small 19 mm)

~~\$5~~



SBM25

Large Spiral Band
Rubber Mandrel
(large 25 mm)

~~\$5~~



Truly sticky!

Sticky Products

Get a grip. Our sticky products are perfect for trimming dinnerware and low-profile pieces. The sticky bat firmly grips greenware for easy and efficient trimming.

The sticky bat is my favorite new tool! I wish I had it years ago. The surface is almost gummy feeling & my pieces stay put extremely well without lugs of clay hold them down like I was using before. I've even used a trimming chuck on it & it worked well. It saves me a lot of time being able to just center the piece & trim!

— Jessica

Works really well with the sticky bats! If you're already getting a sticky bat, definitely pick one of these up too. This trimming spinner makes "side" trimming easier, and I have fewer pots fly off the wheel when trimming.

— Charissa N.

STICKY BATS

\$36

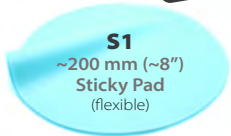

S1
~200 mm (~8")
Sticky Pad
(flexible)

\$48

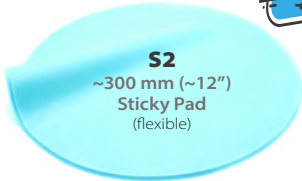

S2
~300 mm (~12")
Sticky Pad
(flexible)

(bottom)

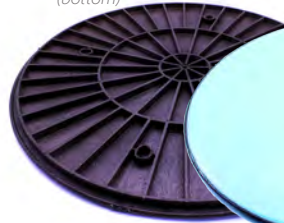

\$82

S3
~355 mm (~14")
Sticky Bat
(rigid)

(top)



\$72 ea.

S10
~300 mm (~12")
Colored Sticky Bat
(rigid)

\$13



S4 XL

\$10



S4

\$7



S4 XS

S4
(48 mm (~2") in diameter)
S4 XS
(31 mm (~1.25") in diameter)
S4 XL
(75 mm (~3") in diameter)
Pottery Trimming
Spinner



The CINK

Say goodbye to the headache of clogged drains, and say hello to DiamondCore® Tools The CINK. This stand-alone, mobile clay water recycling system keeps clay out of drains in any studio, classroom or home.

The CINK:

- Collects clay and recirculates water – with no mess!
- Four-stage clay filtration down to 1 micron
- Reusable string filter and bag filter
- On/off pump with adjustable spray nozzle
- Multidirectional wheels with locking casters
- Restaurant-quality stainless steel
- Self-contained; not connected to a water or plumbing system
- Preassembled; unpack, check connections and add water

I love my CINK. I live in Cali and being in a constant state of drought being able to reuse water so easily is really great. I also did not have a sink deep enough and equipped with a shower head so in terms of cleanup and work surface it is very practical. I love the team at DiamondCore, great customer experience.

— Ariane P.J.



\$5

SS POL
Stainless Steel
Cleaner and Polish
(4 oz.)

\$2,650

CINK
The CINK Classic
(includes 1 extra string filter,
1 extra bag filter and CINK
Accessories Set)

\$3,050

CINK DLX
The CINK Deluxe
(includes The CINK Classic,
1 extra bag filter and CINK
plus the Explorer Pottery
Carver Set and the 3-piece
diamond grinding disc G Set)



The CINK Deluxe shown

\$3

SPGXL
Large Cleanup
Sponge



\$5

TWL
Microfiber Towel
(Package of 3
each 40 cm x 40 cm)

\$29

CINK SF
Replacement String Filter



\$19

CINK BF
Replacement Bag Filter





Wood and Metal Ribs

DiamondCore® Tools is always adding items you can't live without to our extensive line of products. Our wood and metal ribs are tools you'll reach for again and again!

These beautifully stained wood ribs come in three sizes but serve one purpose: to give your ceramics a smooth shape. A layer of wax oil protects these ribs as you use them with water while throwing. Though they'll easily glide over clay, these ribs won't slip from your hands. Engraving on the front and back provides a tactile surface that's easier to grip. Choose from large, medium or small for the rib that's just right for your piece.

Each of our flexible, stainless-steel ribs is simple yet elegant. The unique Arc Carving Metal Rib is the stencil you never knew you needed to replicate curved lines all across your work. The Large Metal Rib smooths, scores and helps cut clay cleanly with convenient measurement notches. Last but not least, the Small Metal Rib scores, smooths and features varied centering holes on its corners.

WOOD AND METAL RIBS



WR1
Wood Rib
50 mm



WR2
Wood Rib
75 mm



WR3
Wood Rib
100 mm



MRIB1
Arc Carving
Metal Rib



MRIB2
Small Metal Rib



MRIB3
Large Metal Rib



Additional Products

DiamondCore® Tools prides itself on an extensive line of innovative products, but we're not stopping there. Our research and development team is constantly in the lab, designing new, cutting-edge tools for a worldwide community of artists.

Our diamond grit products and carving tools are our cornerstones, but we're excited to carve out new markets. Visit [DiamondCoreTools.com](https://www.DiamondCoreTools.com) online to discover additional products you'll absolutely love.

You wouldn't believe how handy these little brushes are. Super easy to use and definitely the tool you needed that you didn't think you needed.

— **Bonny K.**

Stop hesitating! Click "purchase" now! Five minutes after I opened this bargain box I ordered another one. It's an amazing value! I received three different carving tools and two sanding blocks. And, let's remember that DiamondCore tools are the best around ... buy it. BUY IT!

— **Amy**

ARC SHAVER

\$42

ARC1
Arc Shaver 1



\$8

POTTERY SPONGES



SPG1
Pottery Sponge
(tough)



SPG2
Pottery Sponge
(medium)



SPG3
Pottery Sponge
(fine)



ADDITIONAL PRODUCTS

\$7

S4 XS
(31 mm (~1.25")
in diameter)
Pottery
Trimming Spinner



\$13

S4 XL
(75 mm (~3") in diameter)
Pottery Trimming
Spinner

\$10

S4
(48 mm (~2") in diameter)
Pottery Trimming
Spinner



\$5

FG
Extra Foam Grips
(6-piece set, colors vary)

\$5



FGXL
XL Foam Grip
Egg Shape
(colors vary)

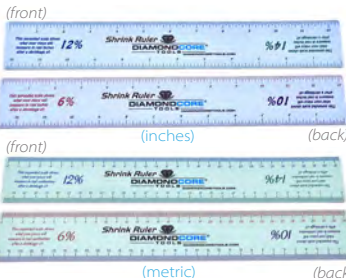

\$19

SR
Shrink Ruler
(double-sided, sold individually)

\$19

SRM
Metric Shrink Ruler
(double-sided, sold individually)

\$7 ea.



BR1
Finger Brush
(rough)

BR2
Finger Brush
(medium)

BR3
Finger Brush
(fine)



~~\$18 ea.~~

14BT BRN
14" Brown Round Bat

~~\$16 ea.~~

12BT BLU
12" Blue Round Bat

12BT BRN
12" Brown Round Bat

~~\$12 ea.~~

75BT GRN
7.5" Green Square Bat

12BT GRN
12" Green Round Bat

12BT ORG
12" Orange Round Bat

12BT RED
12" Red Round Bat



~~\$28~~

FB14
355 mm (~14")
Foam Trim Bat



~~\$12~~

FOAM 14Y
355 mm (~14") Diameter
Foam Circle, 1" Deep

SAFETY PRECAUTIONS

DiamondCore® Tools are intended to be used by artisans who craft with mediums such as clay, stone, glass and more. All safety precautions should be followed at all times.



Common Sense

For all other items not listed here but available for purchase by DiamondCore® Tools, use common sense and best practices as you would with any small tool. Please see website for additional details and information: www.diamondcoretools.com.



Diamond Sanding & Grinding

Use with water. Wear safety glasses or goggles (or a face shield with safety glasses or goggles) and a dust mask, as small particles may become dislodged and fly in the air. Do not operate with gloves, loose clothing, long exposed hair or jewelry.



Carving, Trimming and Handheld Extruders

Wear safety glasses or goggles (or a face shield with safety glasses or goggles) as small particles may become dislodged and fly in the air. Always use protective eyewear when changing blades. Use protective gloves as needed and warranted by the work being performed.



Diamond Stylus Tools

Use with water. Wear safety glasses or goggles (or a face shield with safety glasses or goggles) as small particles may become dislodged and fly in the air. Tips are not replaceable once broken or used down to the nub.



Rotary Tools

Use with water. Wear safety glasses or goggles (or a face shield with safety glasses or goggles) and a dust mask, as small particles may become dislodged and fly in the air. Never hold a small workpiece in one hand and the tool in the other hand while in use. Clamping a small workpiece allows you to use your hand(s) to control the tool. Never lay the power tool down until the accessory has come to a full stop.



The CINK

Please refer to The CINK manual for a full description of the unit's safety precautions. Reminder: The CINK is designed to rinse equipment, capture clay and recirculate water. It does NOT generate potable water. For additional guidance, call DiamondCore® Tools at 619-905-9400 or email info@diamondcoretools.com.



Water

Always use diamond sanding, grinding and rotary tools with water.

Children

Keep tools out of the reach of children at all times.

Hole Drills

Use with water and cordless drills. Never mix water and electric tools that require a plug into a socket.



Pottery Multi-Tool and Folding Blades

Wear safety glasses or goggles (or a face shield with safety glasses or goggles), as small particles may become dislodged and fly in the air. Blades on the Pottery Multi-Tool and Pottery Knife and tips on the Needle Tool and Scoring Tool are extremely sharp. Keep Pottery Multi-Tool and single Folding Blade Tools closed when not in use. Always use protective eyewear when replacing blades.



Changing the World of **Ceramic Arts**
Glass Arts
Lapidary Arts
Wax Arts
And More



680 W. Bradley Ave.
El Cajon, CA 92020
619-905-9400
diamondcoretools.com
info@diamondcoretools.com