



Tel: 626-246-1094 • 800.414.5109 • Fax: 626-443-0267

# SPECIFICATION SHEET

## SPJ8040

Wall Mount

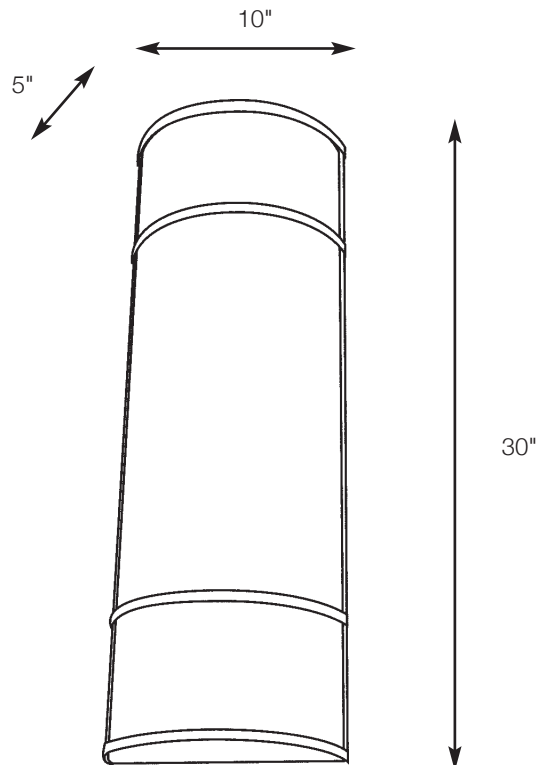

- MODEL:** SPJ8040
- MATERIAL :** Brass or Aluminum
- FINISH :** Specify
- ACRYLIC :** Specify
- ELECTRICAL :** 120v - 277v
- SOCKET :** 1 Medium Base
- LAMP :** Specify
- FLUORESCENT OPTIONS :** PL-13W, PLT-26W, PLT-32W, PLT-42W



*Specify Wet Location* 

DRAWN BY: MMC

BASE DESIGN: SPJ

DATE: 01-10-10

## SPJ LIGHTING INC.

2107 Chico Avenue  
South El Monte, CA 91733  
(800) 469-3637 FAX: (626) 433-4839