

# SPJ40-05A

Column Lantern

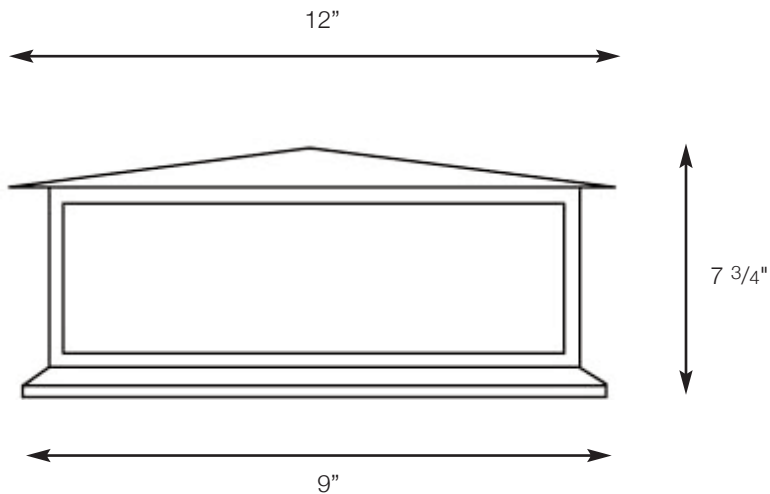

<b>MODEL:</b>	SPJ40-05A
<b>MATERIAL :</b>	Solid Brass
<b>FINISH :</b>	Specify
<b>GLASS :</b>	Specify
<b>ELECTRICAL :</b>	120v or 12v
<b>SOCKET :</b>	Medium Base
<b>LAMP :</b>	Specify
<b>FLUORESCENT OPTIONS :</b>	PL-13W, PLT-26W, PLT-32W, PLT-42W
<b>MOUNTING :</b>	Column Mount



DRAWN BY: MMC

BASE DESIGN: SPJ

DATE: 01-10-10

## SPJ LIGHTING INC.

2107 Chico Avenue  
South El Monte, CA 91733  
(800) 469-3637 FAX: (626) 433-4839