

Border Lite Wall Spot

Cat. No. BLWS
Cat. No. BLWS/R



The Border Lite Wall Spot is a wall-mounted luminaire with a fully adjustable head allowing for 360 degree rotation and 0-90 degree elevation. This makes the luminaire ideal for wash-lighting on pillars, columns or walls.

The luminaire is cast from virgin high corrosion resistant low copper aluminium with a UV stable powder coated finish, solid bronze or 316 stainless steel with a clear, tempered flush glass lens and high temperature silicon gasket.

The Retro™ is a 110/240-12 ac mains option suited to installation where mounting a transformer is a problem, e.g. a brick wall where there is only a cable protruding out of the wall and it is not an option to recess the transformer. The base increases in size to accommodate the encapsulated dimmable transformer.

Ordering Information

Luminaire Type

BLWS - Border Lite
Wall Spot

Material/Finish

BK - Black
BZ - Bronze
GN - Green
STAR - Silver Star
WH - White
WB - Birch
DG - Dark Grey
OG - Olive Green
RG - Beige
PR - Primrose
SS - 316 Stainless Steel
SBZ - Solid Bronze

Accessories

LENSBLC - Clear Lens
/R - Retro™ Transformer
110/240-12 volt

Ordering Example: BLWS SBZ - Border Lite Wall Spot in Solid Bronze
(Accessories ordered separately)

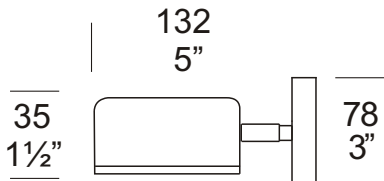

28
1 1/8"

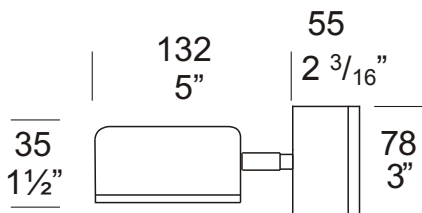

Retro™

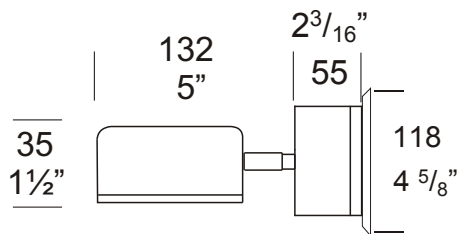

USA/CANADA Retro™



HUNZA™ PURE
OUTDOOR
LIGHTING

HUNZA FACTORY
130 Felton Mathew Ave
Glen Innes
Auckland 1072
New Zealand

Ph: 64-9-528 9471
Fax: 64-9-528 9361
hunza@hunza.co.nz
www.hunza.co.nz

INTERNATIONAL CONTACTS:
www.hunza.co.nz/contacts.php

Specifications may change without notice.
Manufactured in New Zealand.
© 2011 Hunza Holdings Ltd.

Ver 1.4

Luminaire Construction

CNC machined from the following metals:

Aluminium:

Head: Cast from virgin high corrosion resistant CC401 low copper aluminium alloy, with chromate substrate and high UV resistant polyester powder coat

Base: Cast from virgin high corrosion resistant CC401 low copper aluminium alloy, with chromate substrate and high UV resistant polyester powder coat.

Colours Black, Bronze, Green, Silver Star, White, Birch, Dark Green, Olive Green, Beige, Primrose.

Solid Bronze:

Head: Investment cast in Bronze.

Base: Copper hand spun 2mm.

Stainless Steel:

Head: Investment cast 316 Stainless Steel.

Base: Investment cast 316 Stainless Steel mounting plate.

Mounting

The mounting plate is fixed to the wall using two screws.

Features

Lens:

3mm Frosted tempered shatter resistant glass with a Lifetime warranty.

Gaskets:

Silicone, 150°C (302°F).

Lamp Holder:

G4 - 350°C (662°F) ceramic multi contact lamp holder with 250°C (480°F) teflon cables.

Accessories:

Clear Lens (Cat. LENSBLC).

Retro™ transformer 110/240-12 volt (Cat. /R).

Swivels: Aluminium and Solid Bronze luminaires - 360° rotation and 0 - 90° elevation, solid brass with anti rust spring.

Stainless Steel luminaires - 360° rotation and 0 - 90° elevation, full stainless steel construction.

Standards

IP66  UL1838

Luminaire Weight

Alum: .400kg (14oz)
BRZ: .750kg (1lb 10oz)
SS: .650kg (1lb 7oz)

Retro:

Alum: .800kg (1lb 12oz)
BRZ: 1.160kg (2lb 9oz)
SS: 1.055kg (2lb 5oz)

Power Supply

HUNZA™ Wall Mount Transformer: not included.

USA and Canada:

HUNZA™ Wall Mount Transformer: not included.

RETRO™

HUNZA™ 110/240-12 volt ac silicon encapsulated electronic transformer built into the Retro base. Dimmable with a suitable dimmer.

Luminaire: supplied with
G4 Bi - Pin 20 watt lamp max.

USA and Canada:

G4 Bi - Pin 20 watt lamp max.

Border Lite Wall G4 20 watt lamp. Lens is at a distance of 600mm (24")

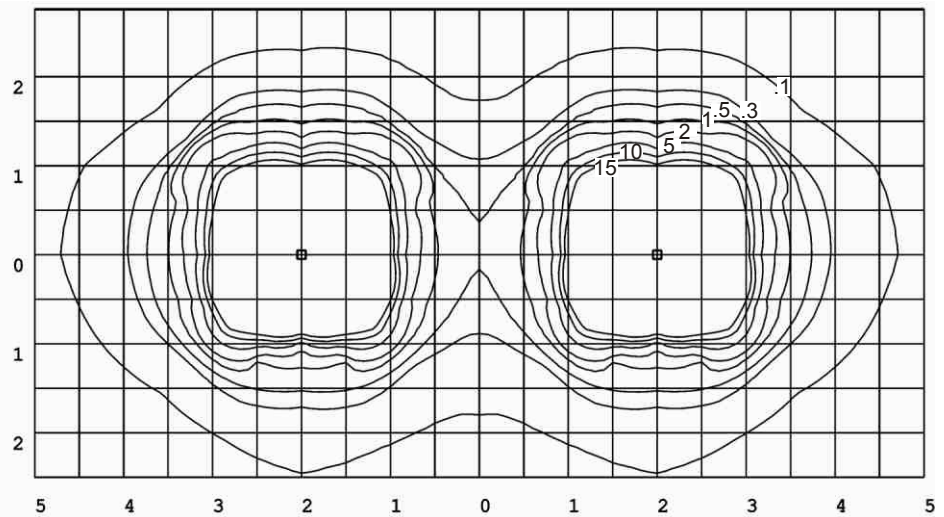
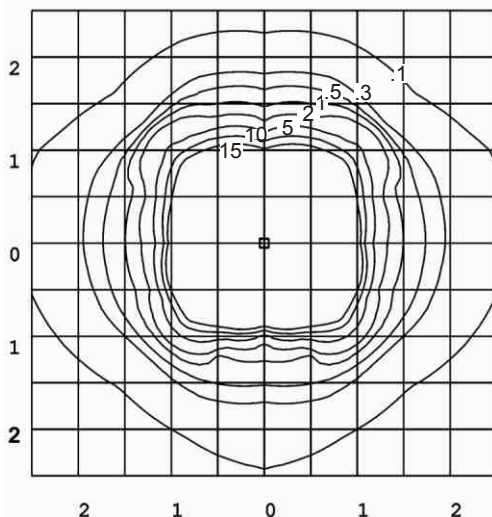

HUNZA™ PURE
OUTDOOR
LIGHTING

HUNZA FACTORY
130 Felton Mathew Ave
Glen Innes
Auckland 1072
New Zealand

Ph: 64-9-528 9471
Fax: 64-9-528 9361
hunza@hunza.co.nz
www.hunza.co.nz

INTERNATIONAL CONTACTS:
www.hunza.co.nz/contacts.php

Specifications may change without notice.
Manufactured in New Zealand.
© 2011 Hunza Holdings Ltd.

Ver 1.4

Border Lite Wall Spot PURE LED

Cat. No. BLWS/L

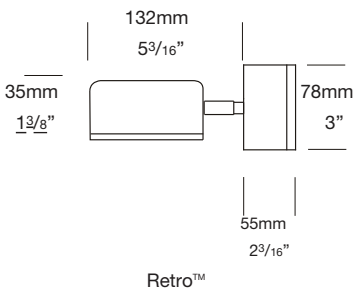
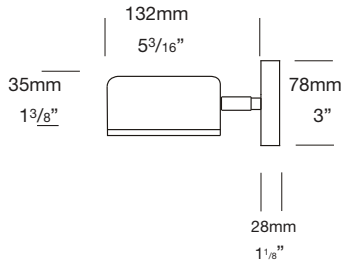

PURE LED
Pure Performance

The Border Lite Pure LED is ideal for path lighting giving a wide spread of light with no upward projection. This luminaire has a fully adjustable arm allowing 360 degree rotation and 0-90 degree elevation.

The Hunza PURE LED system uses Cree XTE chips for maximum performance and long life. Power supply options include a choice of integral 12 or 110 / 240 volt (Retro) drivers which are mounted in the pole. There is also an external remote driver (series connection) option. The PURE LED system incorporates Hunza's Plug-and-Play system for easy replacement of either the LED engine or integral driver in the field.

*At 700mA this fitting is the equivalent of a 20w halogen fitting.
*At 1050mA this fitting is the equivalent of a 35w halogen fitting.

Luminaire

BLWS/L

Driver mA

S - Series
D3 - 12v 350mA
D7 - 12v 700mA
R - 110 or 240v Retro

Colour Temp

2 - 2700K
3 - 3000K
4 - 4000K
39 - 3000K
(90+ CRI)

Accessories

CJK - Cable Joint Kit
LENSBLC - Clear Lens

Material/Finish

BK- Black
BZ - Bronze
GN - Green
STAR - Silver Star
WH - White
WB - White Birch
DG - Dark Grey
OG - Olive Green
RG - Beige
PR - Primrose
SBZ - Solid Bronze
SS - 316 Stainless

Ordering Example: BL/L S 3 CJK BK

HUNZATM PURE
OUTDOOR
LIGHTING

HUNZA FACTORY
130 Felton Mathew Ave
Saint Johns
Auckland 1072
New Zealand

Ph: 64-9-528 9471
Fax: 64-9-528 9361
hunza@hunza.co.nz
www.hunza.co.nz

INTERNATIONAL CONTACTS:
www.hunza.co.nz/contacts.php

Specifications may change without notice.
Manufactured in New Zealand.
© 2014 Hunza Holdings Ltd.

Luminaire Construction

CNC machined from one of the following metals:

Head:

Cast from either 316 stainless steel, LG2 bronze or virgin high corrosion resistant CC401 low copper aluminum alloy, with chromate substrate and high UV resistant polyester powder coat.

Colour: Black, Bronze, Green, Silver Star, White, Birch, Dark Grey, Olive Green, Beige, Primrose

Poles:

Aluminium, Solid Bronze, 316 Stainless Steel 38mm (1½") x 850mm (33½") tube.

Retro™:

Pole - 38mm (1½") x 410mm (16") tube.

Transformer Pole - 63.5mm (2½") x 440mm (17½").

Luminaire Weight

12 volt	Alum	.800kg (1lb 8oz)
	SS	1.6kg (3lb 8oz)
	SBZ	1.7kg (3lb 12oz)

Retro™	Alum	2.00kg (4lb 6oz)
	SS	3.15kg (6lb 15oz)
	SBZ	3.4kg (7lb 8oz)

Features

Cable

Water resistant rubber with HUNZA™ Anti-Syphon™ water barrier system.

Lens

3mm frosted shatter resistant glass.

Lifetime Warranty.

Gaskets

Silicone, 150°C (302°F)

Accessories

Cable Joint Kit (Cat. CJK150)

Clear Lens (Cat. LENSBLC)

Swivel: Aluminium and Solid Bronze luminaires - 360° rotation and 0 - 90° elevation, solid brass with anti rust spring.

Stainless Steel luminaires - 360° rotation and 0 - 90° elevation, full stainless steel construction.

Mounting

Pole 850mm (33½") directly mounted into the earth.

Retro™ - set in concrete

Technical Information

Standards

AS/NZS 61046
IP56/IP66 UL 1838

LED

Cree XTE Plug-and-Play, field replaceable LED board.

Lumen Output: 120 @ 700mA

Lumens Per watt: 60 minimum

CRI Warm White (3000k): 85+

Colour Temp: 2700K, 3000K or 4000K

High CRI Option (3000K): 90+
(lumen output decreases by 15%)

Power Supply

External (Series) Driver

Constant current driver
Output: 3vdc at 700mA maximum

Integral 12 Volt Driver

Input: 12vac 3watt at 700mA
Output: 3vdc nominal, 350mA / 700mA

Transformer

Hunza wall Mount Transformer for use with integral 12 volt driver

Retro 110/240 volt Driver

HUNZA Plug and Play Driver
Input: 120/240 vac 7 watt
Output: 6 dc 700mA
0-10 volt dimming.

Border Lite LED driven at 700mA, lens Height 600mm (24")

